

CINTURO V
2501-0037/8300
8100/2503-0037



220422

- | | | | |
|-----------|--|-----------|---|
| D | MONTAGEANLEITUNG
BEDIENUNGSANLEITUNG | GB | ASSEMBLY INSTRUCTIONS
INSTRUCTION MANUAL |
| NL | HANDLEIDING VOOR DE MONTAGE
GEBRUIKSAANWIJZING | PL | INSTRUKCJA MONTAŻU
INSTRUKCJA OBSŁUGI |
| TR | MONTAJ TALIMATI
KULLANIM KLAVUZU | RU | ИНСТРУКЦИЯ ПО МОНТАЖУ
ИНСТРУКЦИЯ ПО ЭКСПЛУАТАЦИИ |
| RO | INSTRUCȚIUNI DE INSTALARE
INSTRUCȚIUNI DE UTILIZARE | IT | ISTRUZIONI DI MONTAGGIO
MANUALE DI ISTRUZIONI |
| FR | NOTICE DE MONTAGE
MANUEL INSTRUCTIONS | SK | MONTÁŽNY NÁVOD
NÁVOD NA POUŽITIE |
| HU | KÖZGYŰLÉS UTASÍTÁSOK
KEZELÉSI UTASÍTÁS | CZ | MONTÁŽNÍ NÁVOD
NÁVOD K POUŽITÍ |
| SI | NAVODILA ZA MONTAŽO
NAVODILA ZA UPORABO | PT | INSTRUÇÕES DE MONTAGEM
MANUAL DO USUÁRIO |
| ES | INSTRUCCIONES DE MONTAJE
MANUAL DEL USUARIO | HR | UPUTE ZA MONTAŽU
UPUTE ZA UPOTREBU |

L

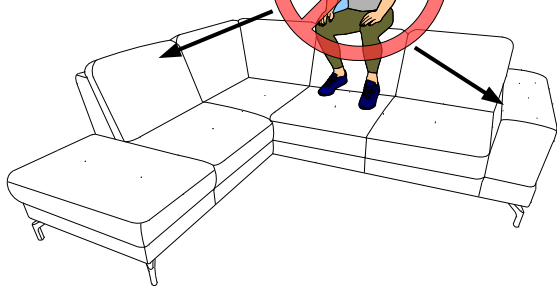
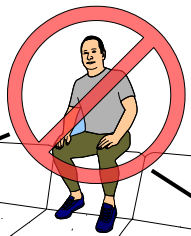

R

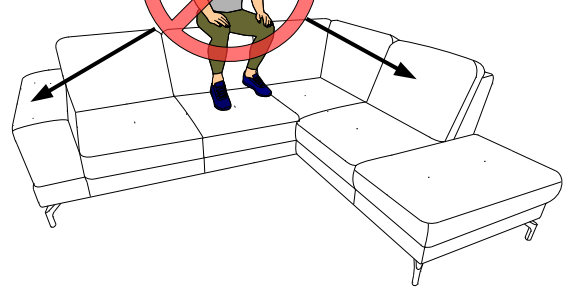



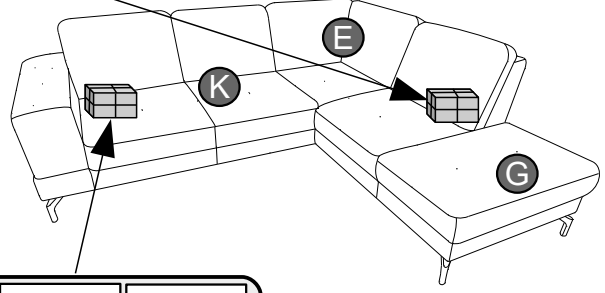
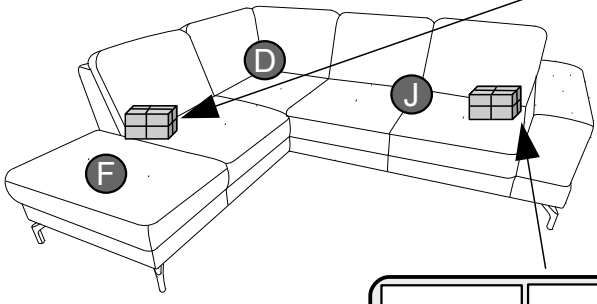
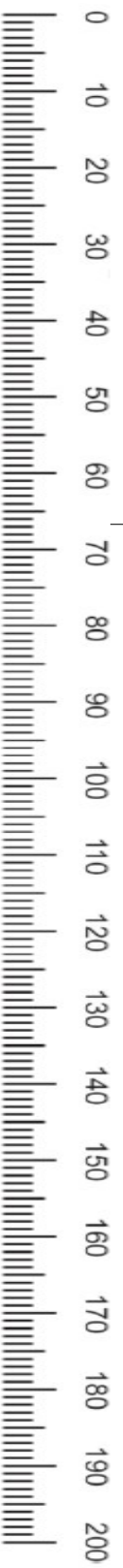

y_{H-150/180} X1	z_{H(150/180)} X3	x_{H-150/180} X3	q M6*25 X12	i L-4 X1	[mm]
--	---	--	---------------------------	------------------------	------

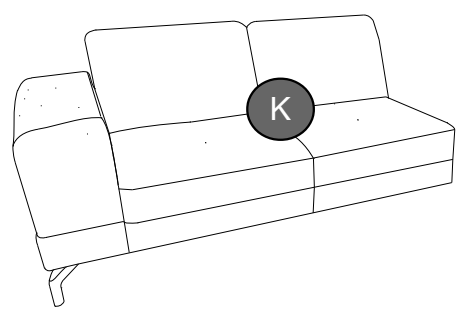
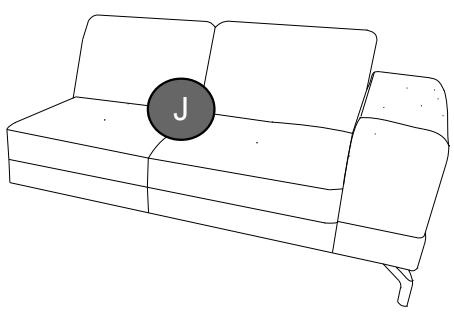
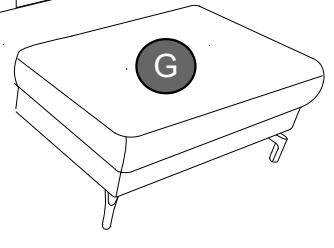
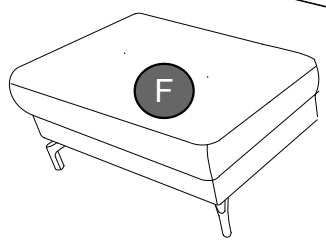
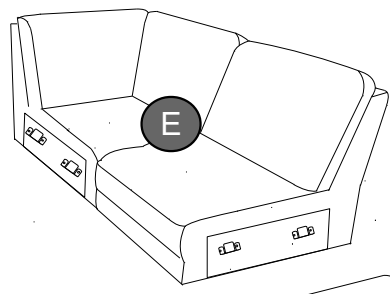
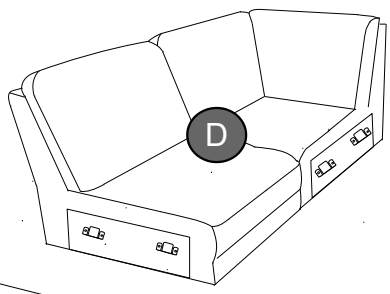

z_{H(150/180)} X2	x_{H-150/180} X2	q M6*25 X8	i L-4 X1
---	--	--------------------------	------------------------



y _{H-150/180} 	z _{H(150/180)} 	x _{H-150/180} 	q M6*25 	i L-4 
X1	X5	X5	X20	X1

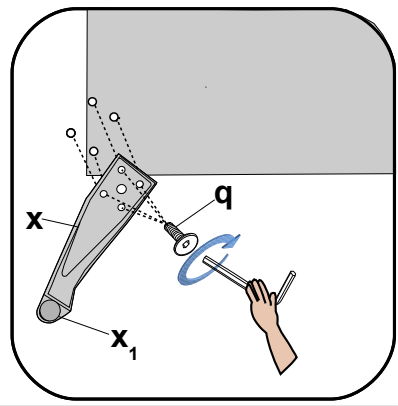
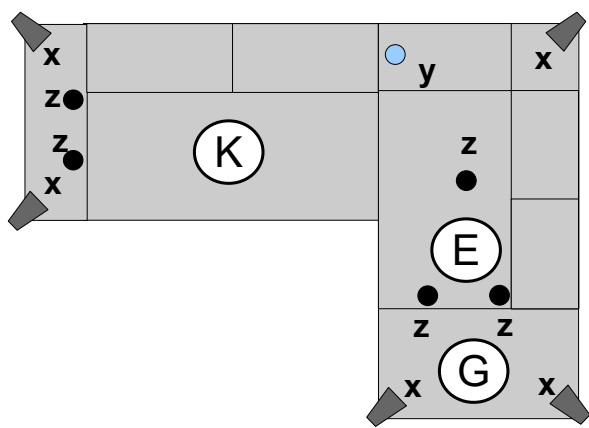
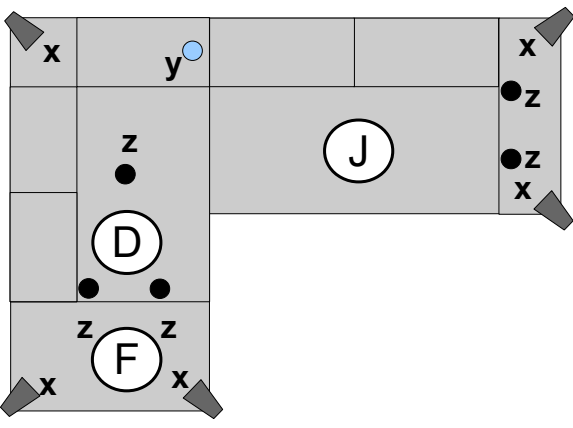
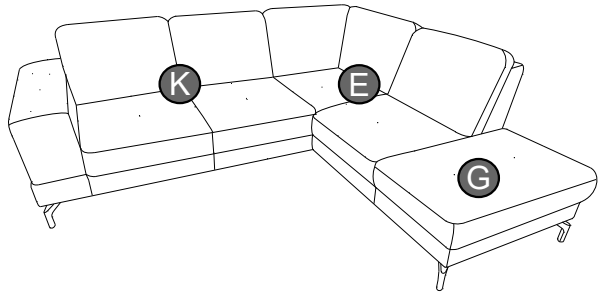
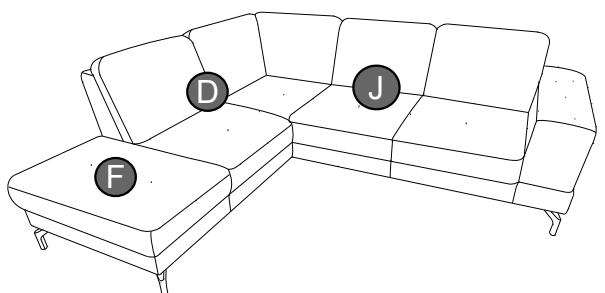



150/180

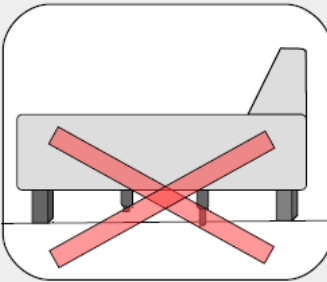

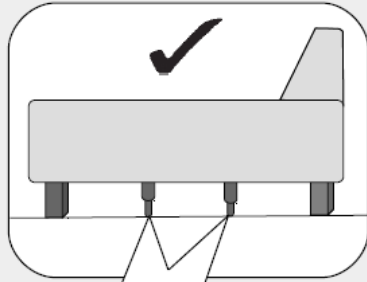



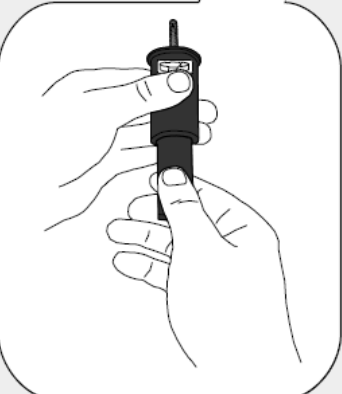

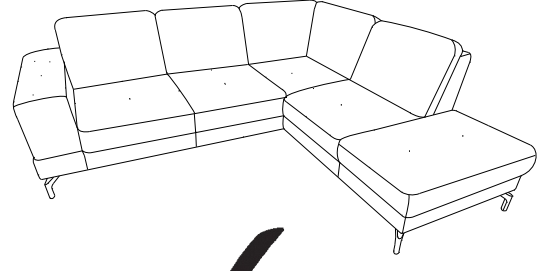
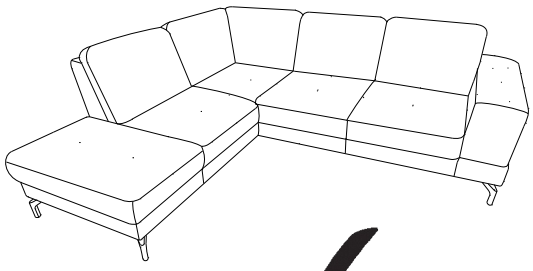
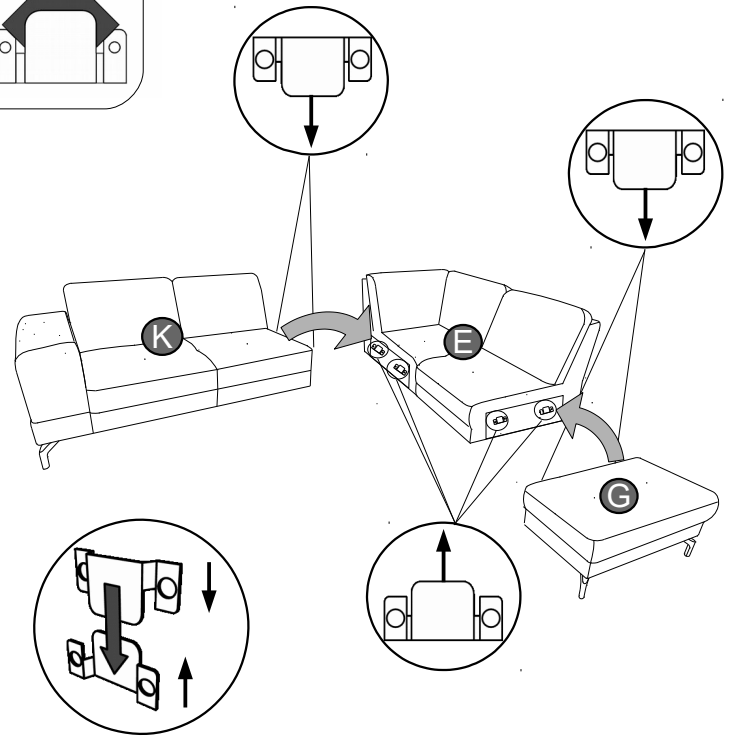
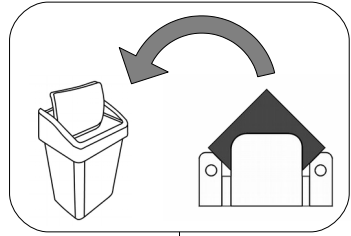
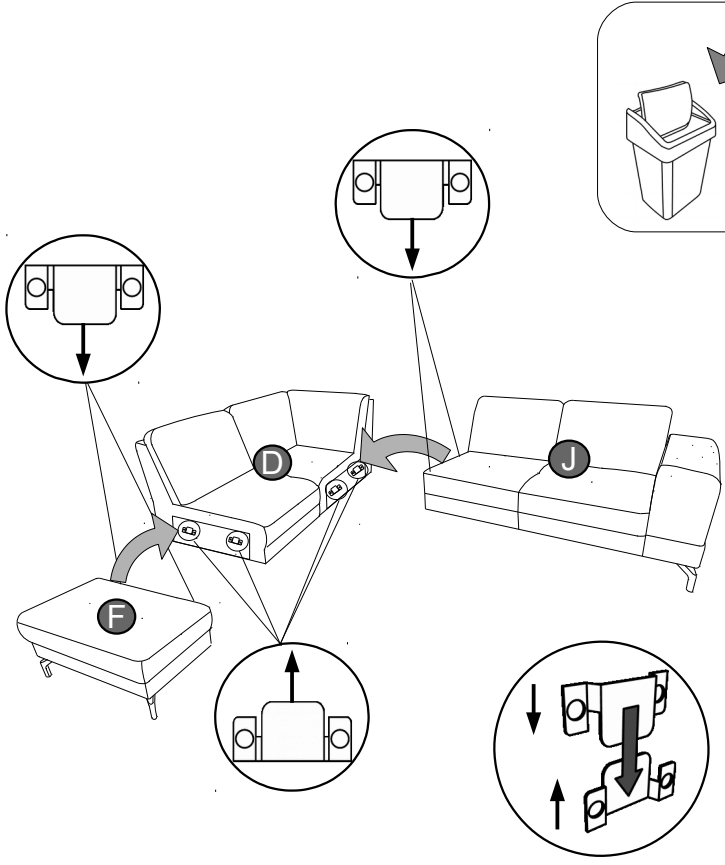

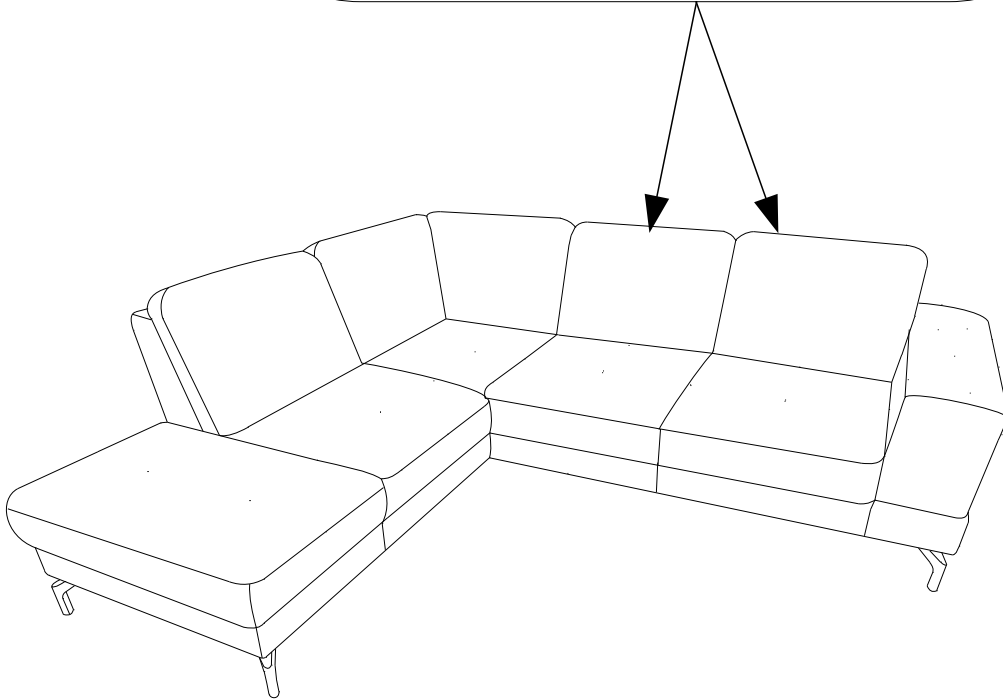
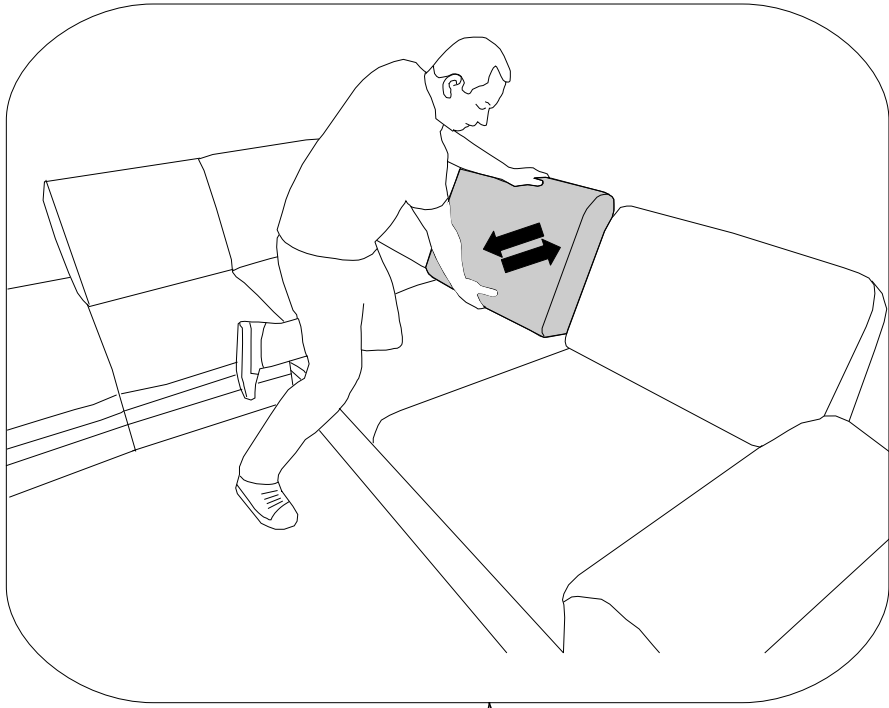



Name · Naam · Nazwa · Ísim · Название · Nume · Nome · Názov · Názov ·
 Název · Neve

CINTURO V

Typ · Type · Tip · Тип · Tipo · Típus

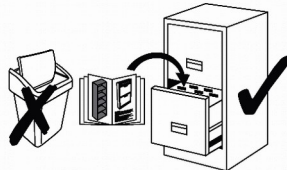
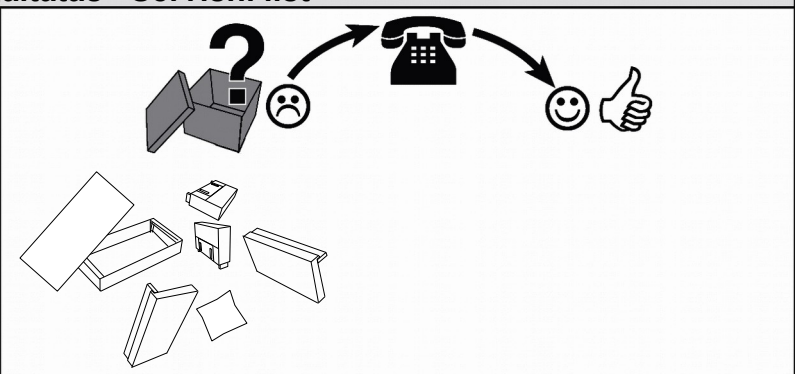



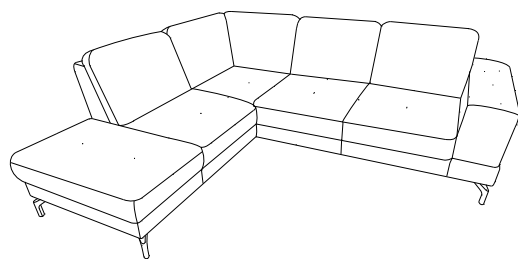

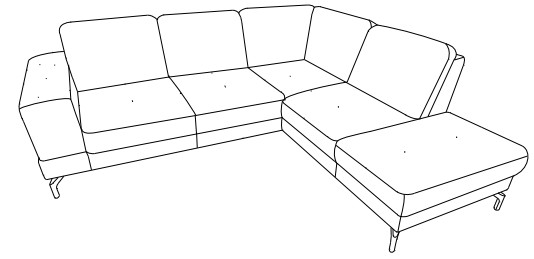

L



R



y H-150/180 	Z H(150/180) 	X H-150/180  X ₁	q M6*25 	i L-4 [mm] 
---	--	---	---	--

