



D Montageanleitung

GB Assembly instructions

FR Notice de montage

NL Handleiding voor de montage

CZ Montážní návod

IT Istruzioni di montaggio

RO Instrucțiuni de montaj

RU инструкция по сборке

PL Instrukcja montażu

SK Návod na montáž

HU Szerelési útmutató

TR Montaj talimatı

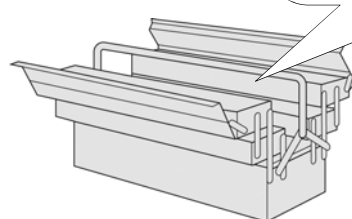
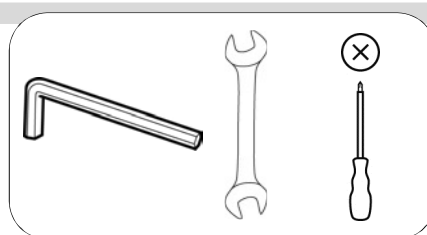
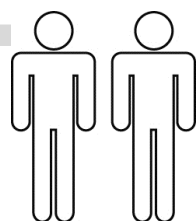
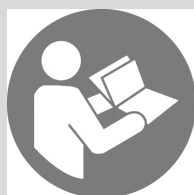

Bei der Montage Kopfteilbrett unbedingt beachten !

**Bettkasten
Außenseite**

**Teil 4
Bettseite-
Innen**

Kopfteilbrett vor der Montage

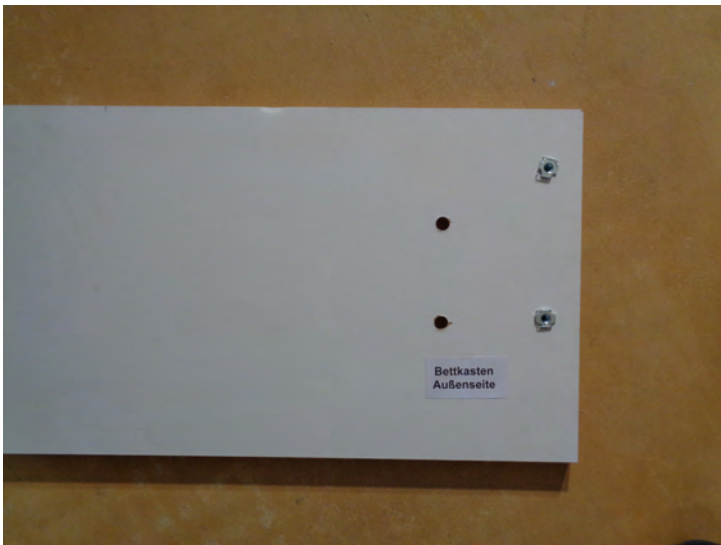

Kopfteilbrett nach der Montage



0
10
20
30
40
50
60
70
80
90
100
110
120
130
140
150
160
170
180
190
200

Service • Assistenza • Dienstverlening • Serwis Servis • Szerviz • Сервисная служба	
Name • Nom • Nome • Naam Nazwa • Jméno • Názov • Név Denumire • İsim • Название	Sierro EB
Nr. • No. • N° • Номер • Č • Sz	SH48-56
Typ • Type • Tip • Típus • Тіро Тип	BK zerl.

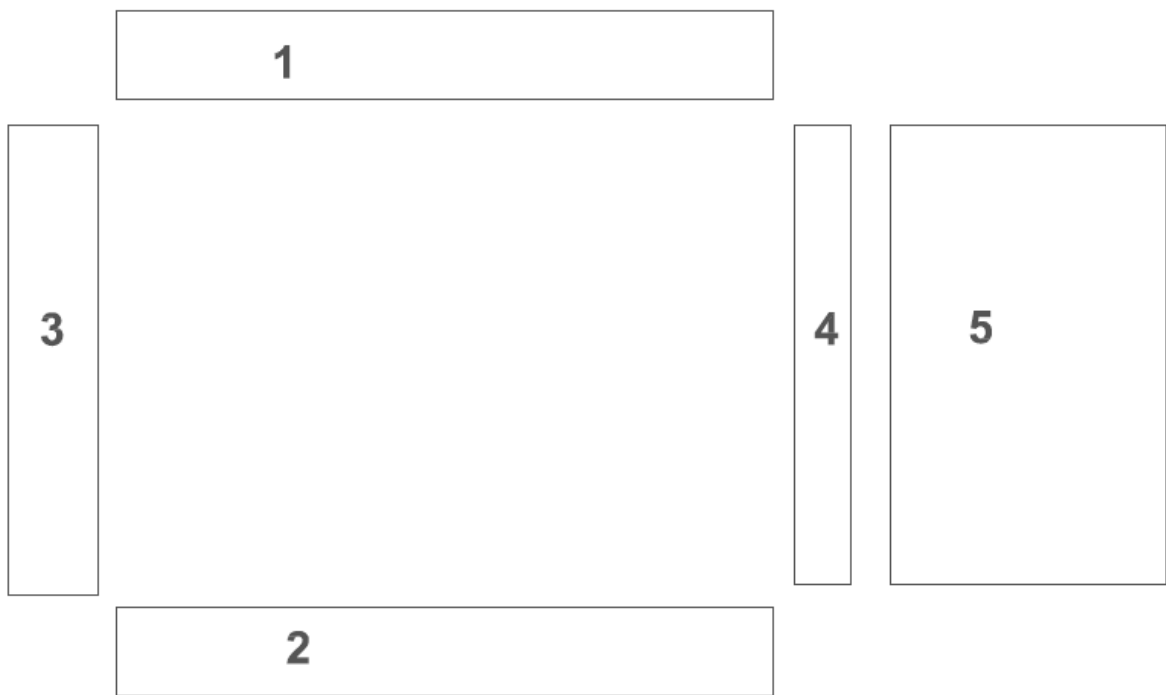

A	B	C	D	E
16x 6x30	4x	16x 3,5x20	4x	4x

G	H	I
4x M8x20	4x 8x20	4x

P	Q	R
4x 8x60	4x 8x40	4x M8



A	B	C	D	E
16x 6x30	4X	16x 3,5x20	4X	4X

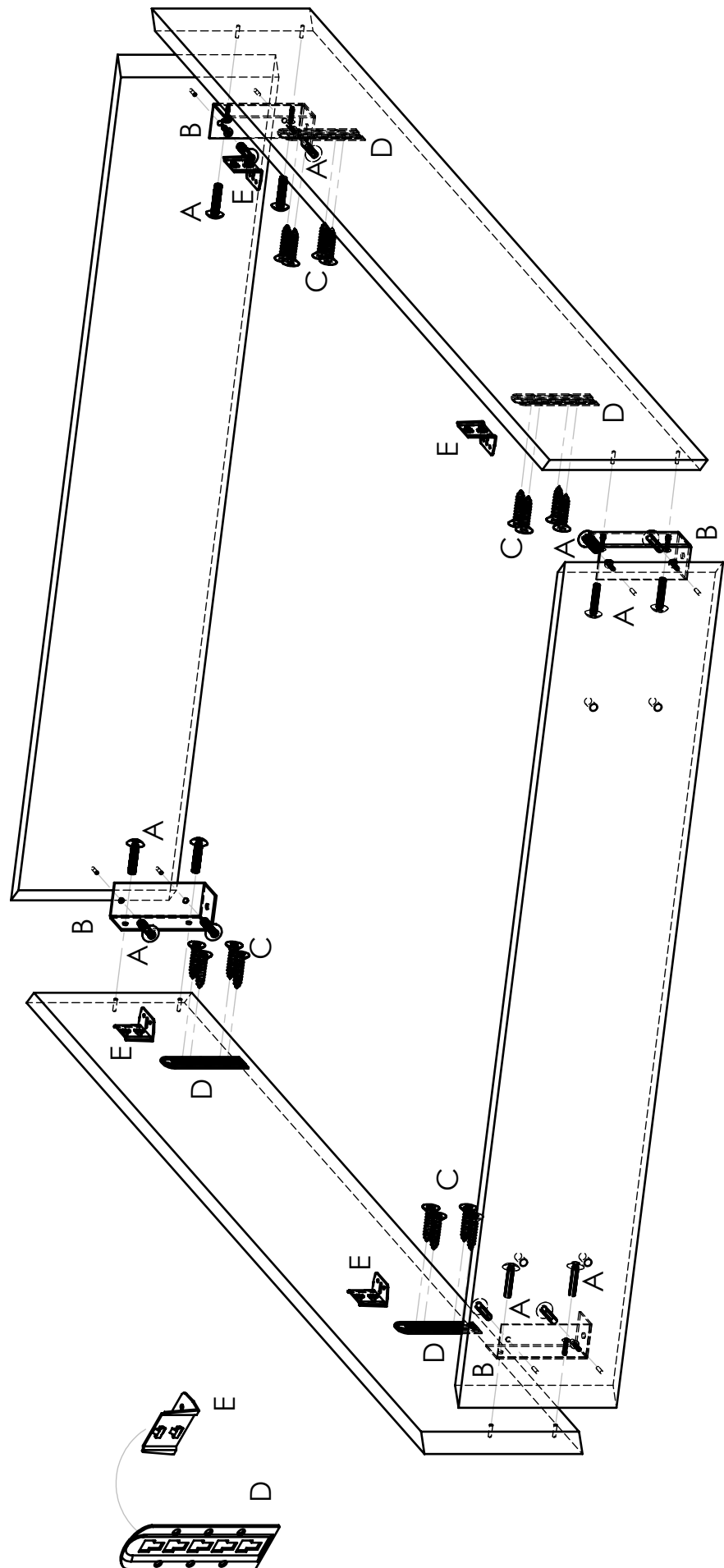

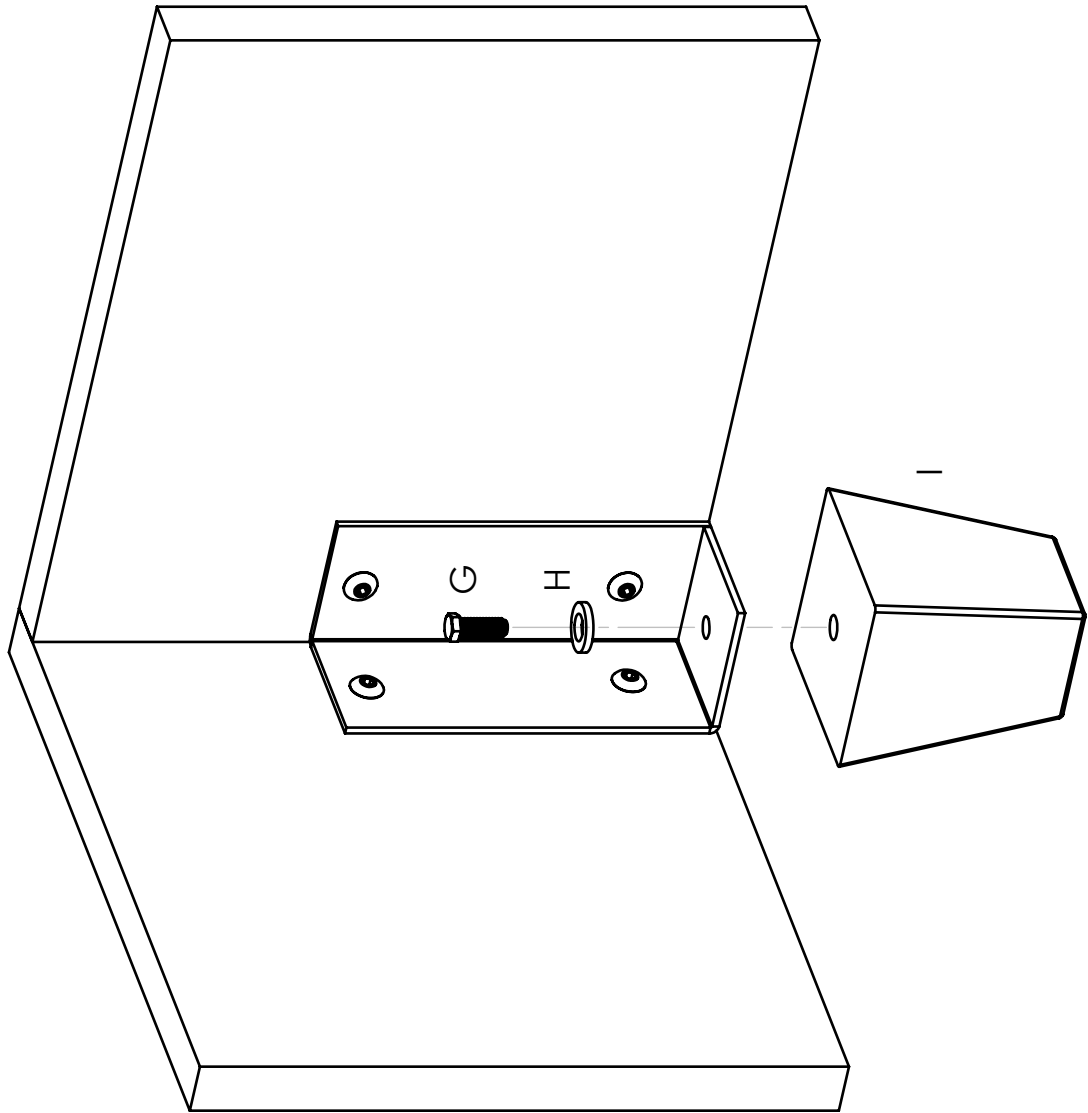

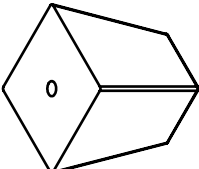
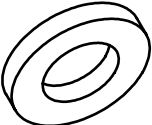
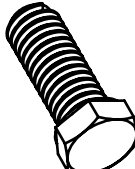

I		4x
H		4x 8x20
G		4x M8x20

3.

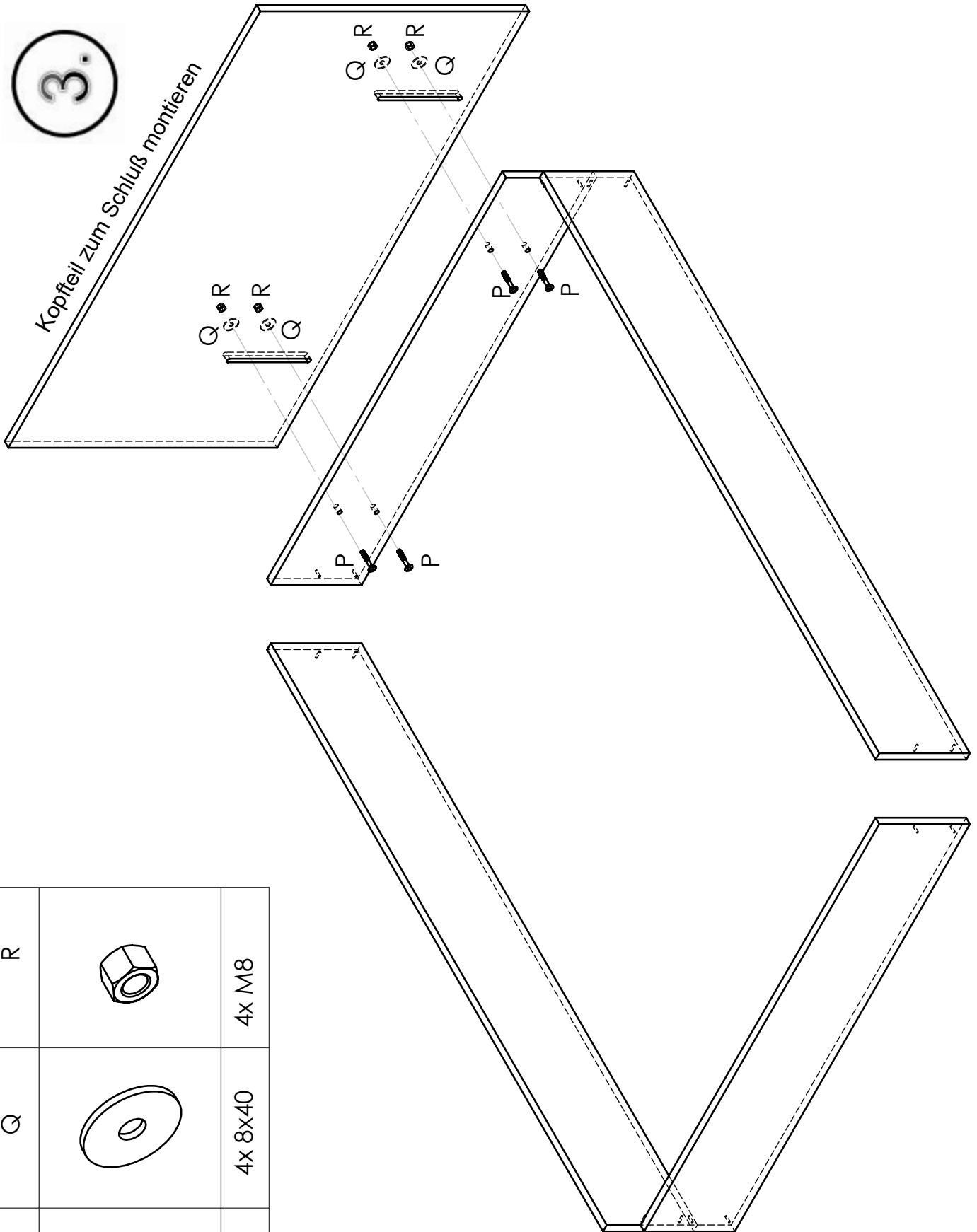
Kopfteil zum Schluß montieren

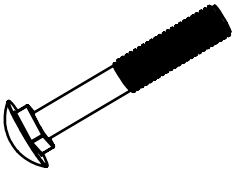
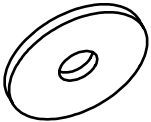

P		4x 8x60
Q		4x 8x40
R		4x M8