

A	A	B
		
	111 229	111 235
	8 x	12 x

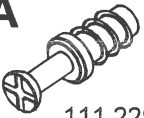

3 x →

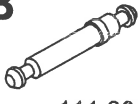

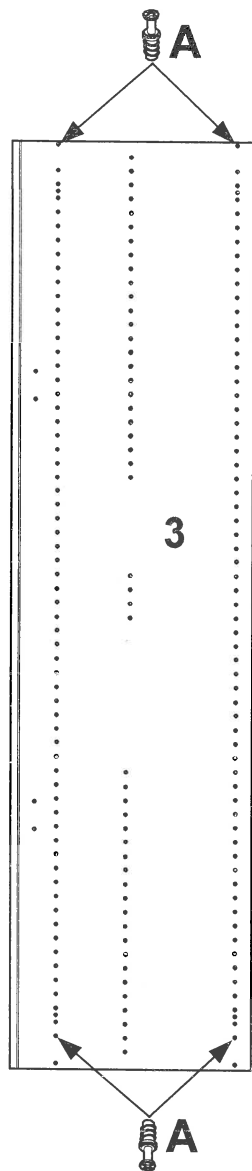
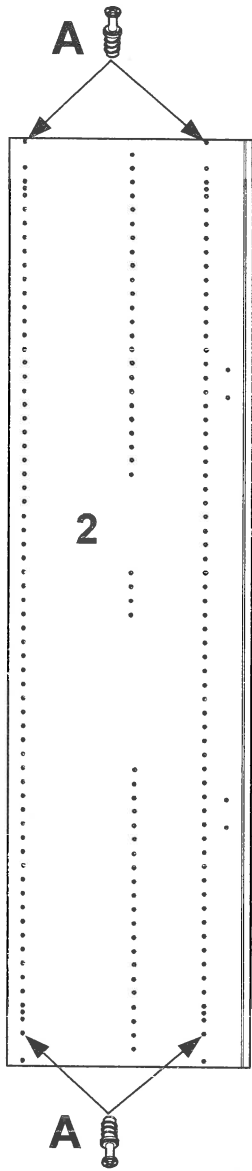
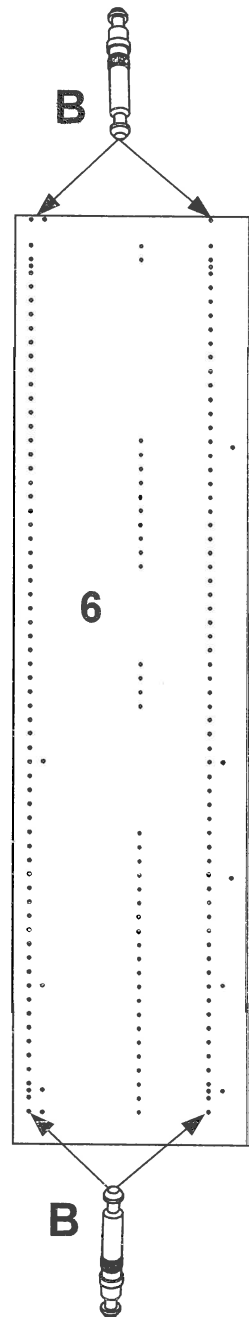
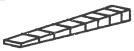

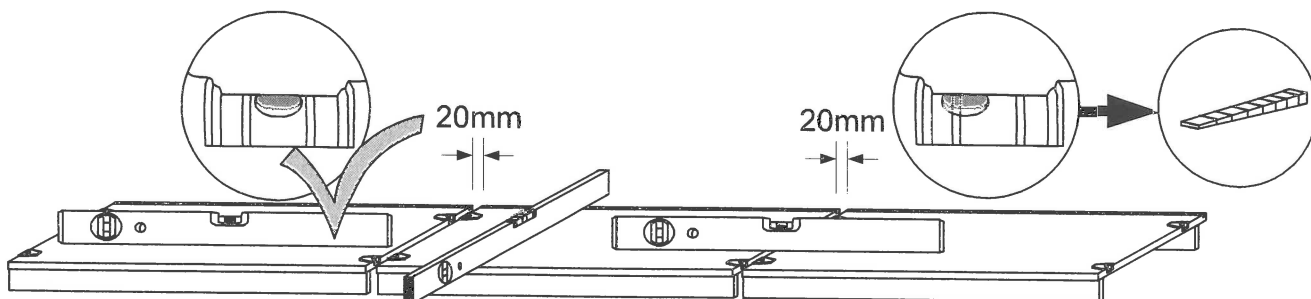
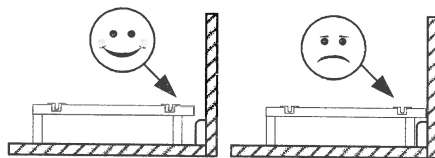
B
M

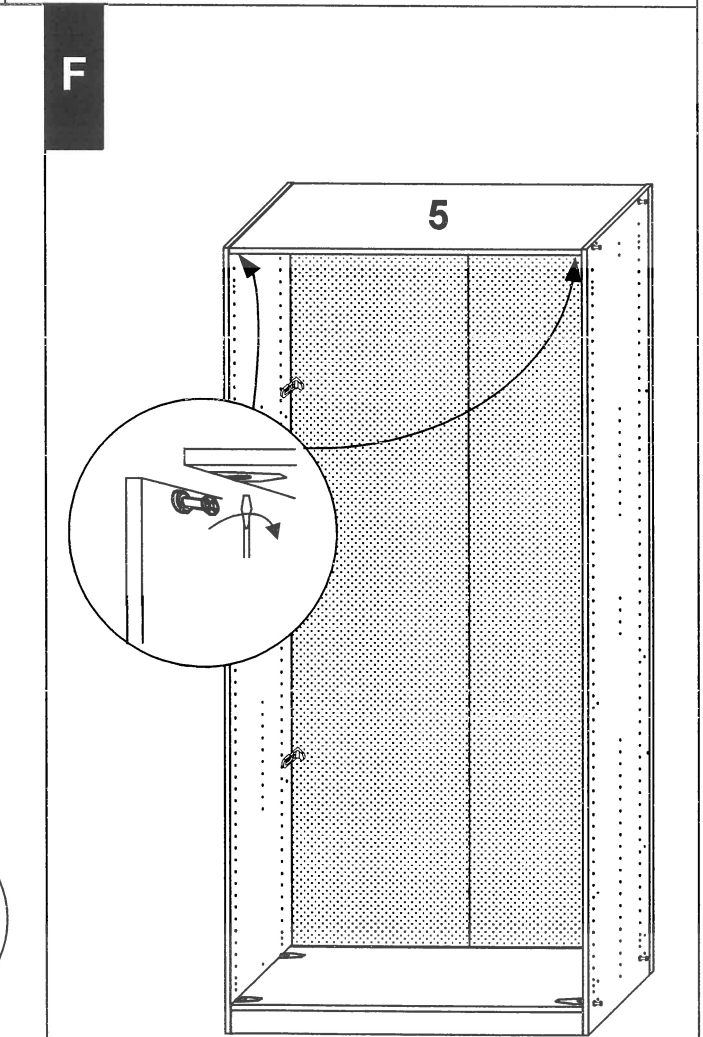
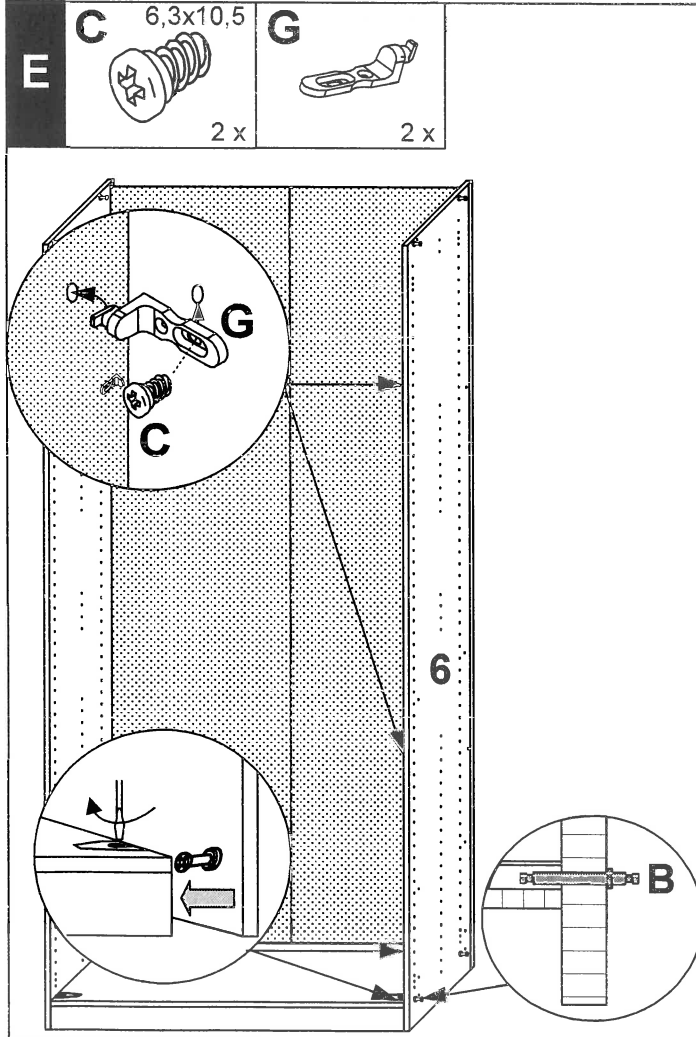
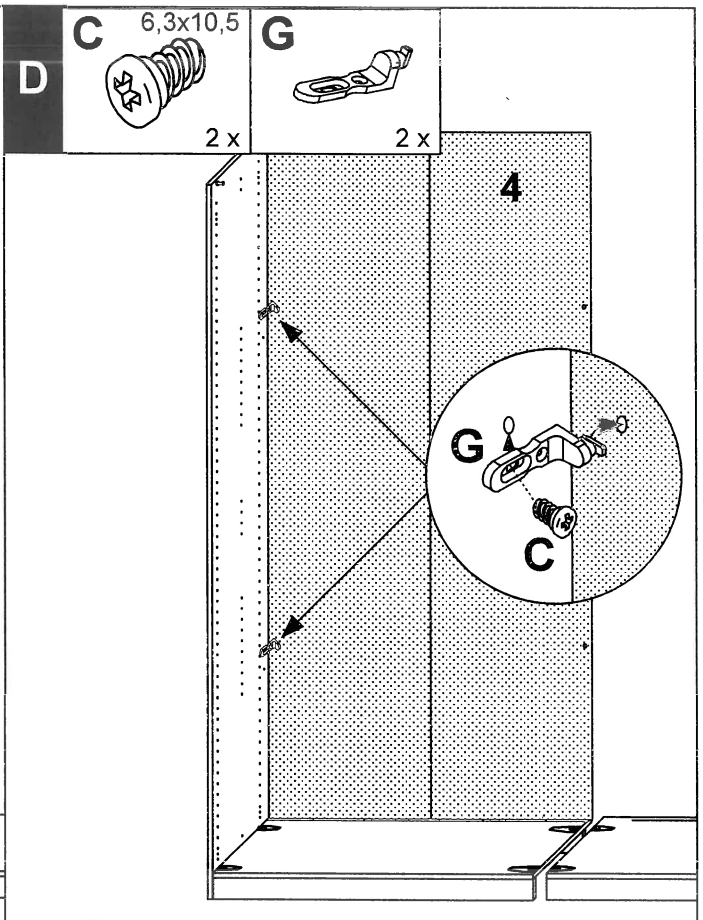
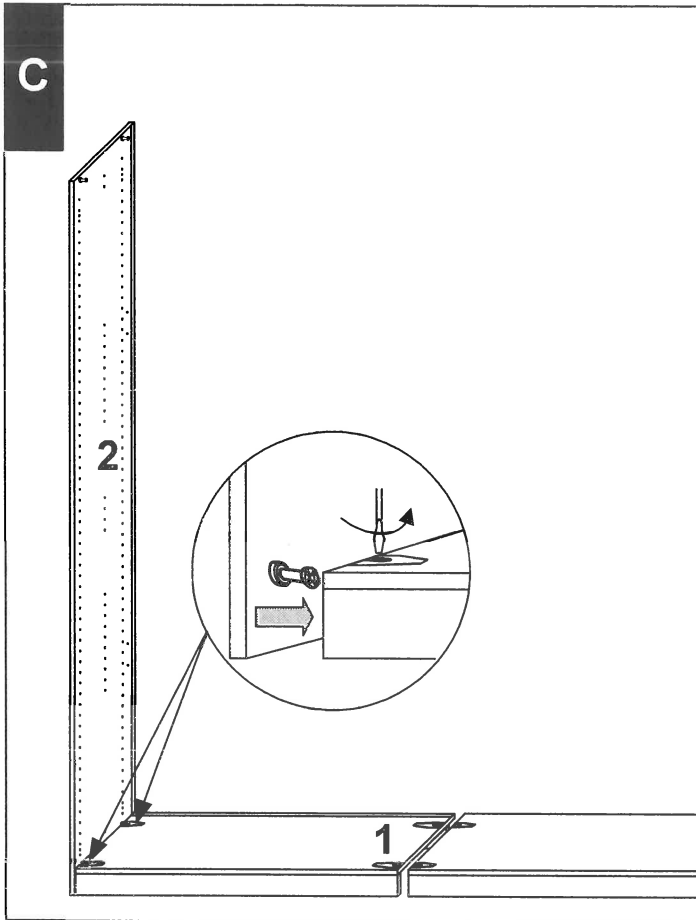
1 x

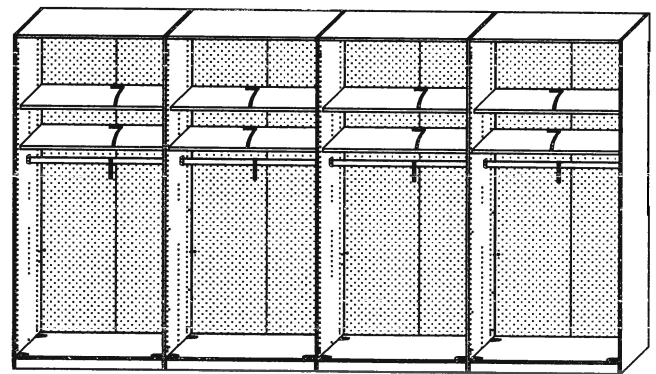
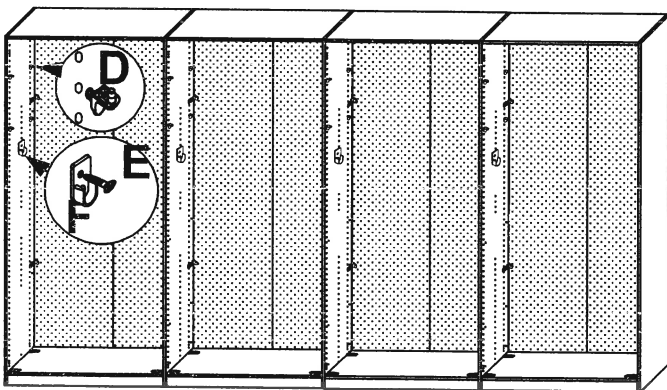
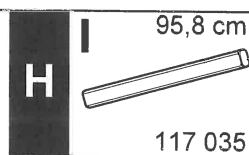
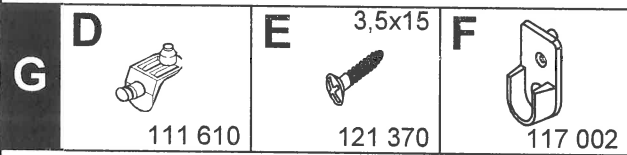
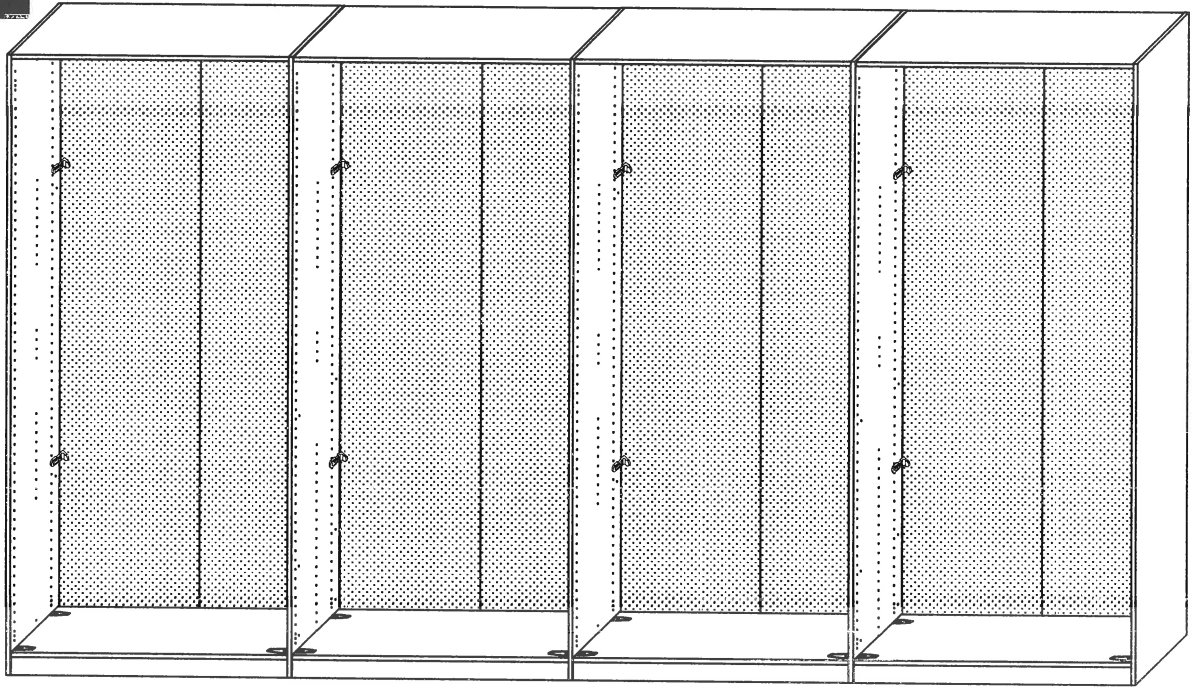
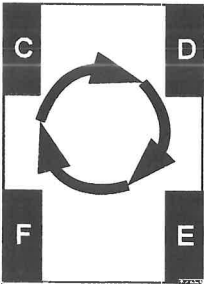

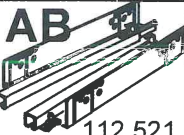



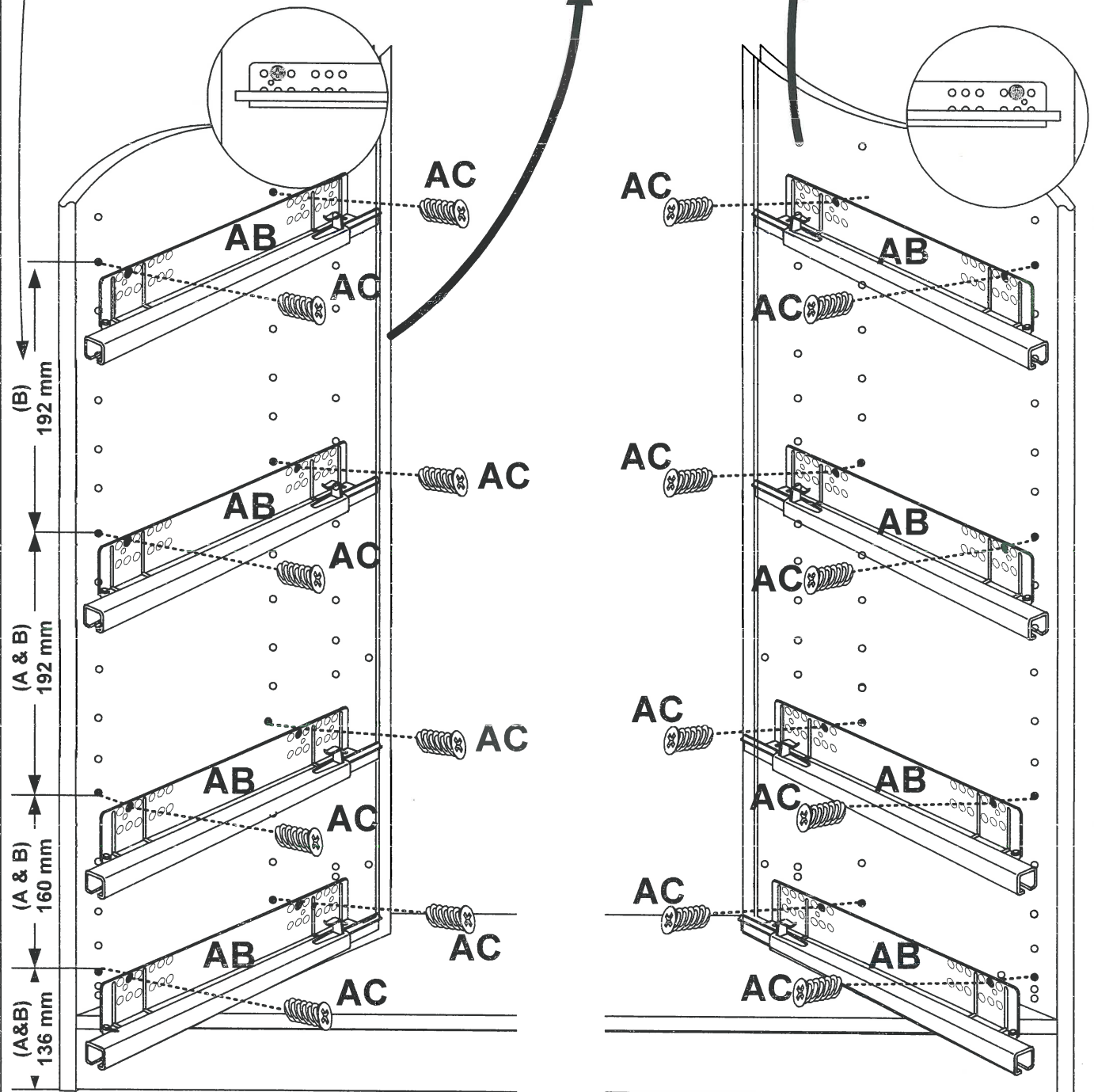
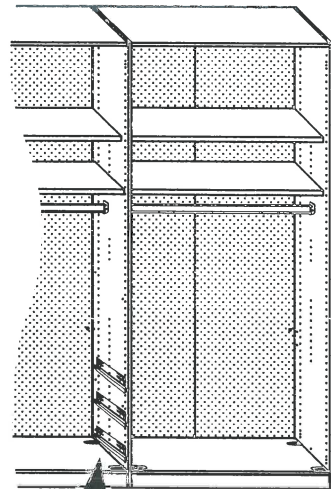
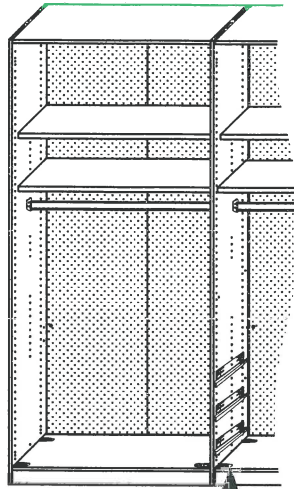
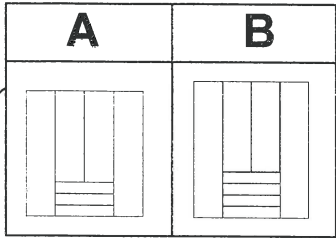

AB	AC 6,3x11
	
112 521	121 167
3-4 x	12-16 x



J	AB	AD M4x8	AE M4
			
	112 521 3-4 x	111 014 6-8 x	113 809 6-8 x

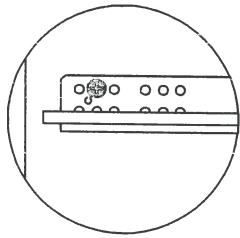
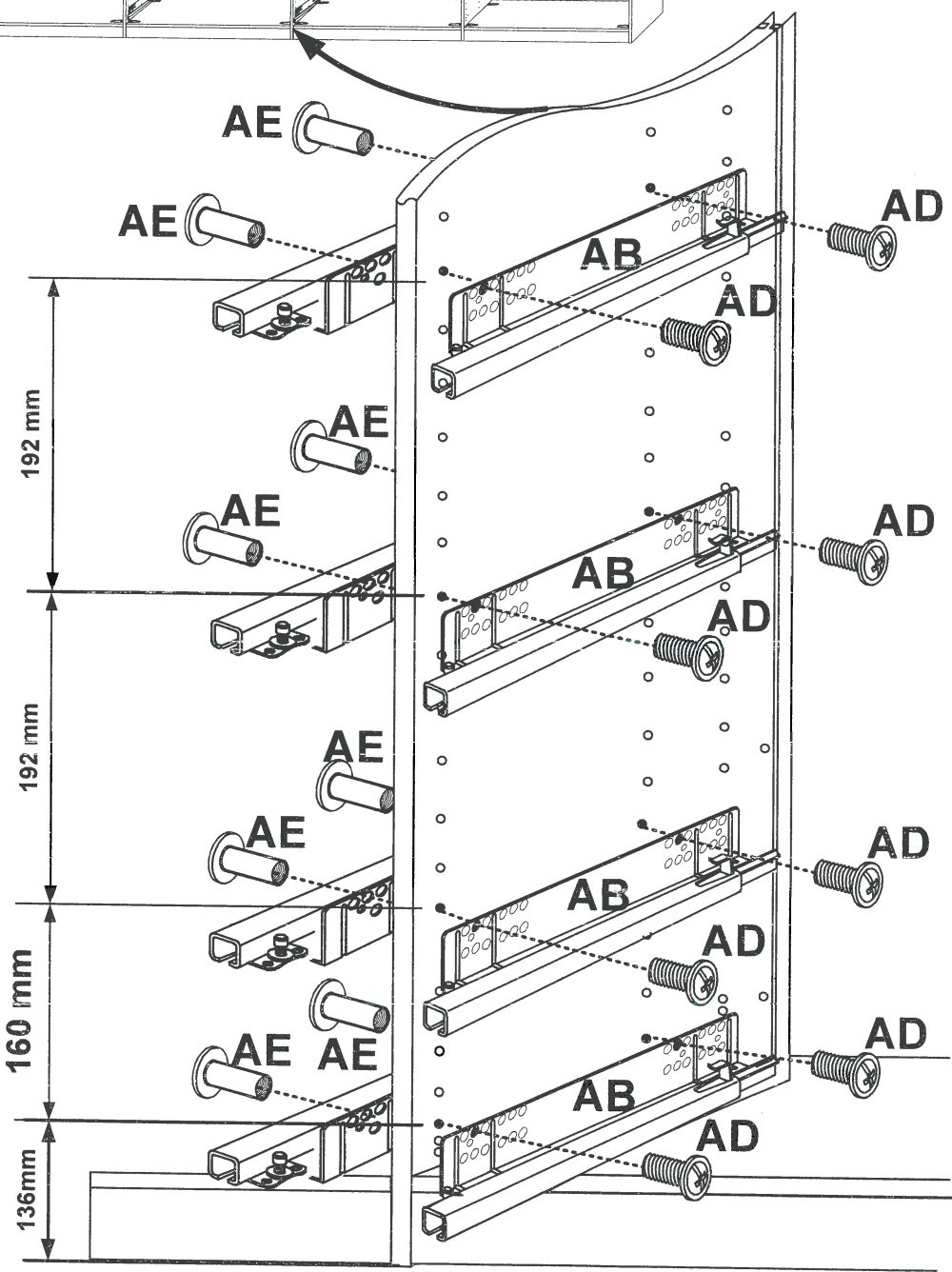
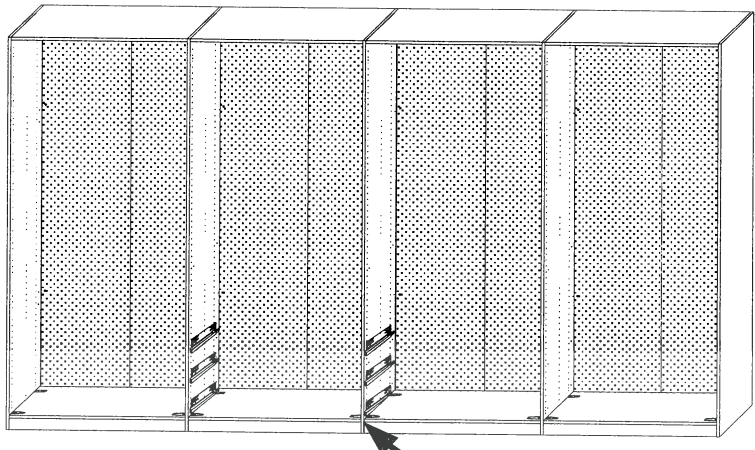

K**A**

111 229



4 x

B

111 235

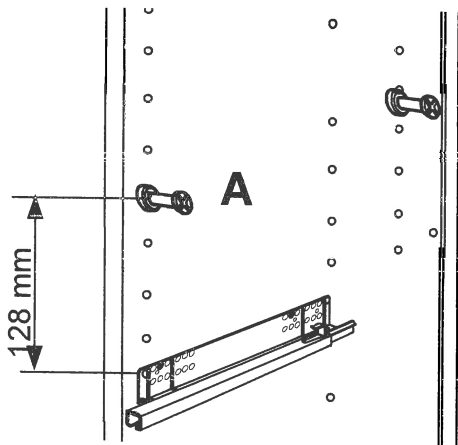
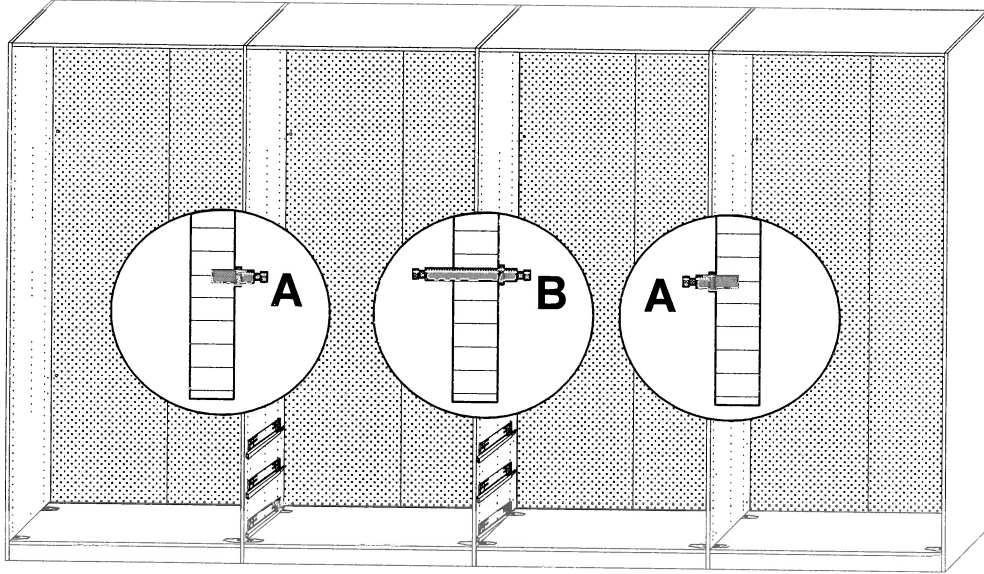
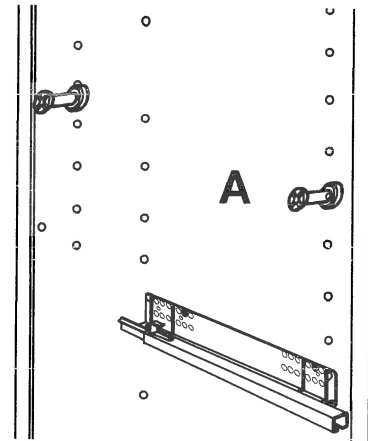
2 x

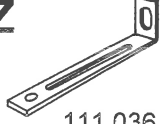
**A****A****A**

L	Z	AA 4,5 x 15
		
	111 036	121 098
	4 x	4 x

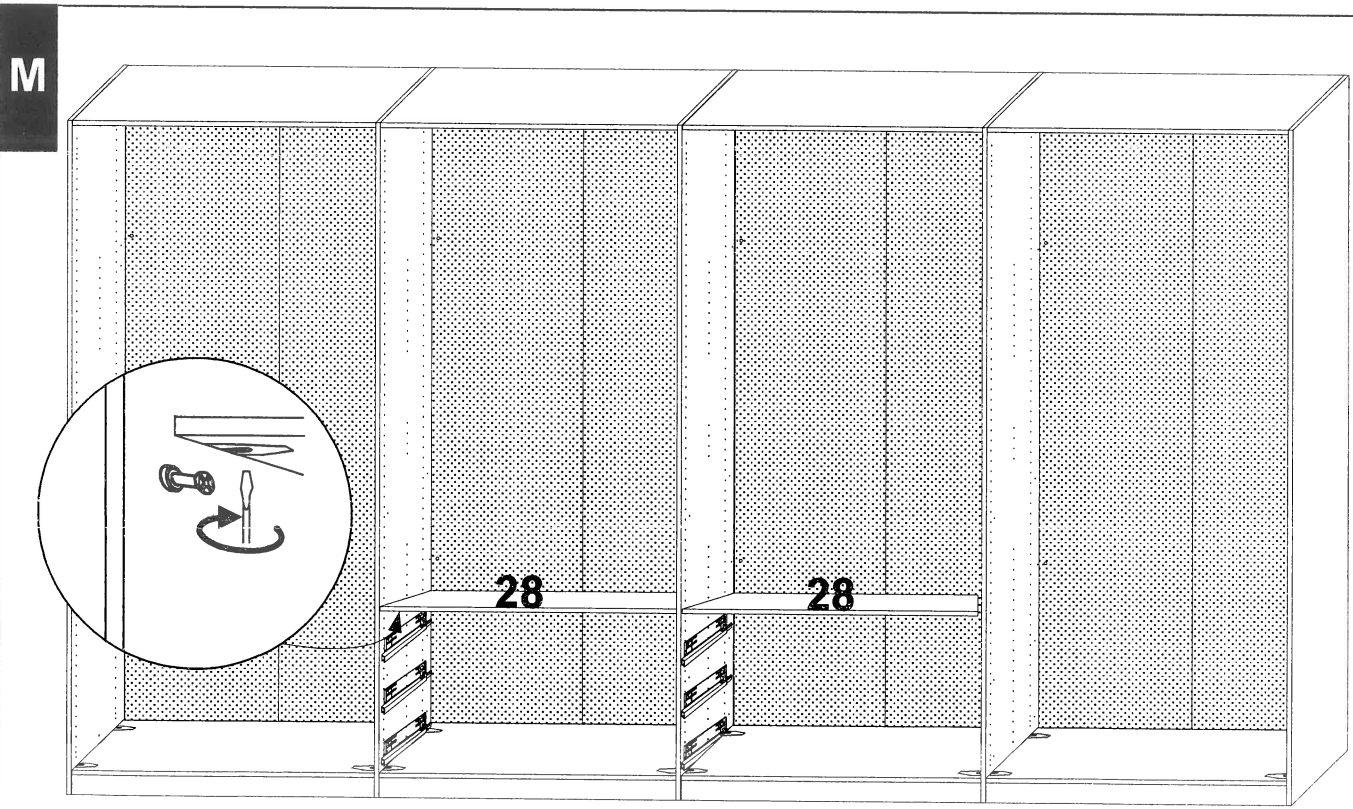
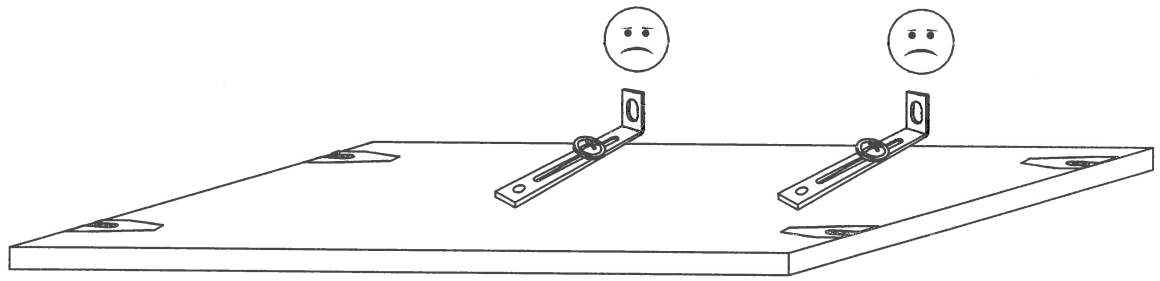
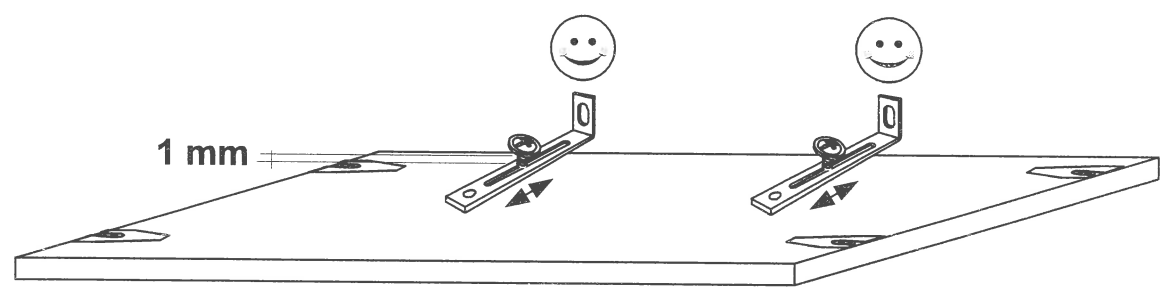
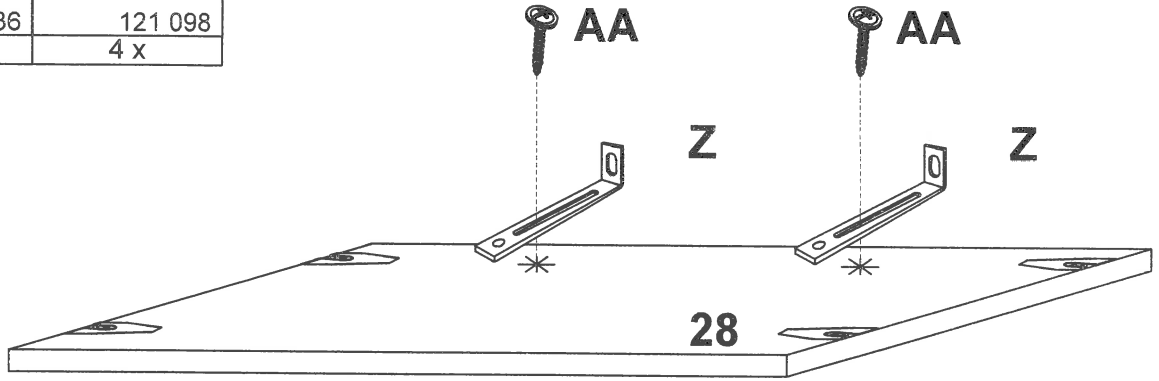

AA 4,5 x 15

N



121 098

4 x

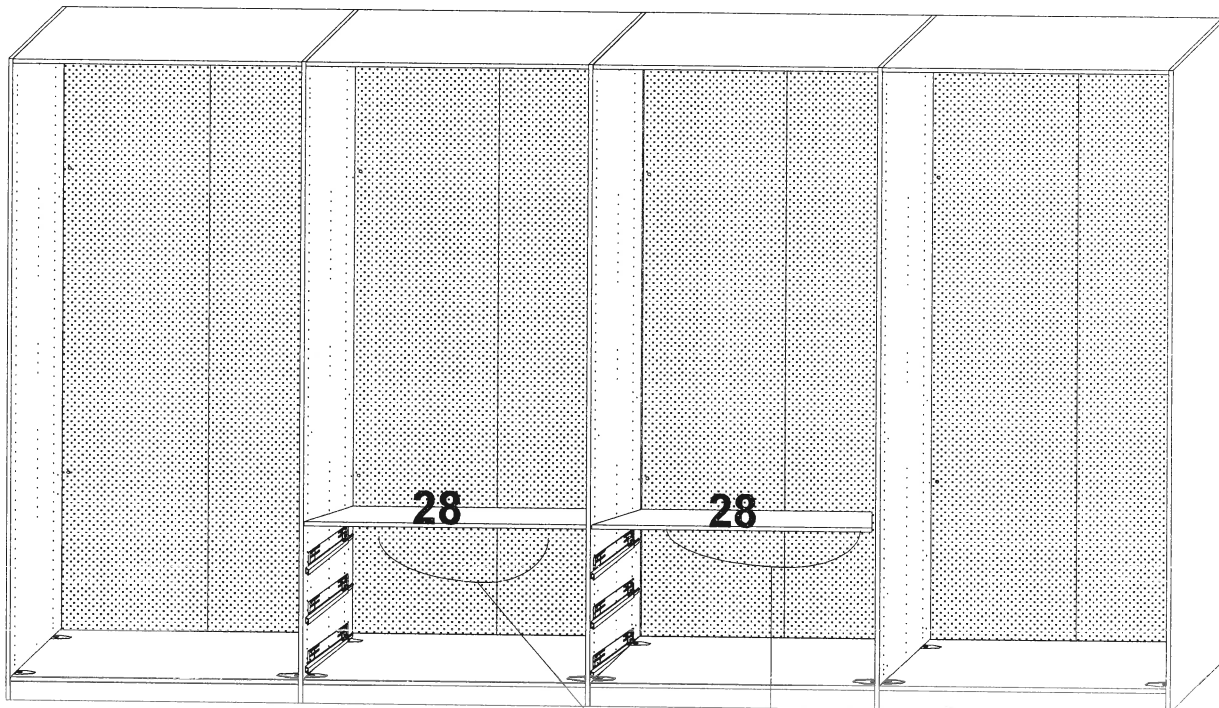

1.

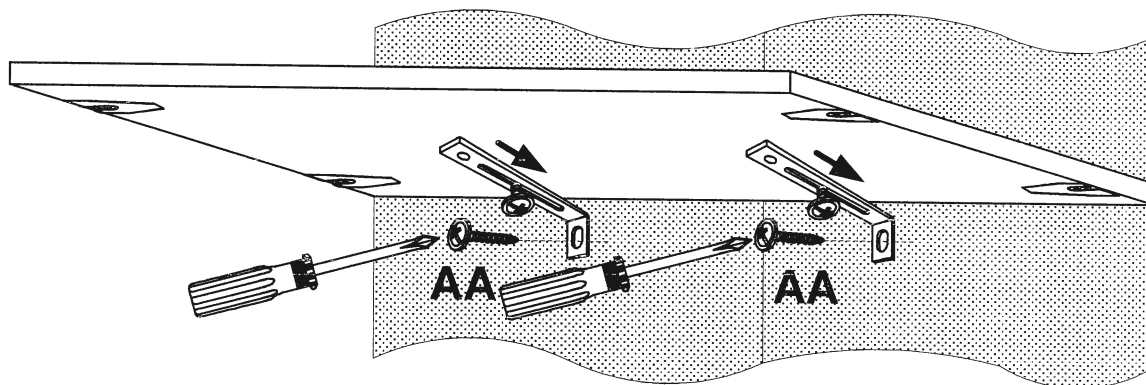

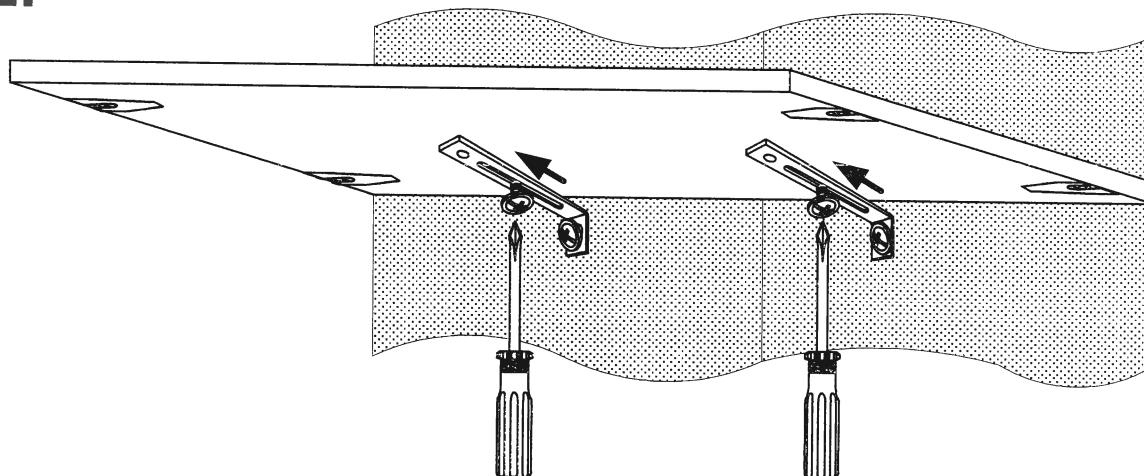

2.

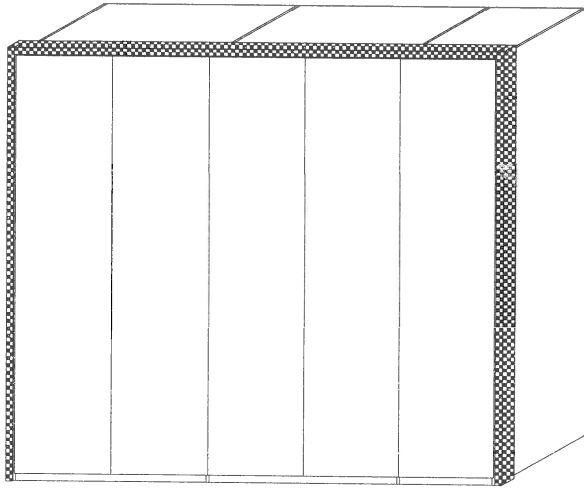
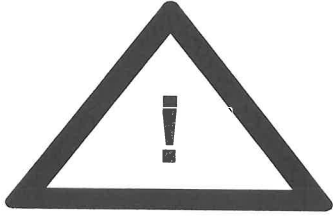

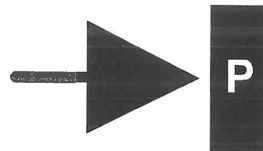
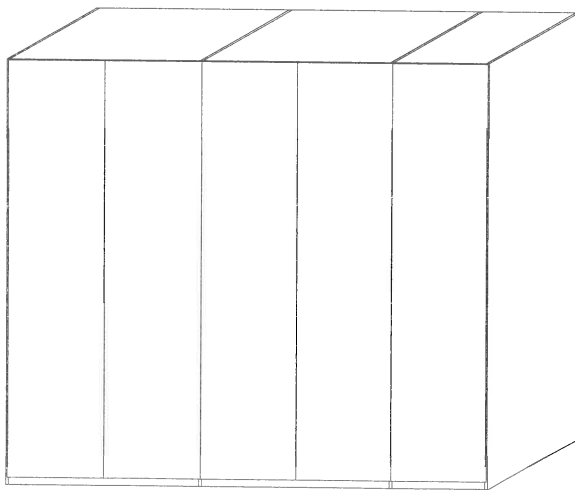
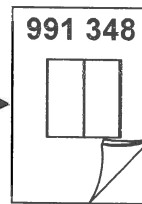

D - Montageanleitung
 GB - assembly instructions
 R - notice de montage
 NL - montage-instructies
 CZ - návod na montáž
 SLO - navodila za montažo
 H - szerelési útmutató
 RO - instrucțiuni de montaj
 I - istruzioni di montaggio
 RUS - монтаж
 TR - montaj talimatları
 PL - instrukcje montażu
 E - ones de montaje
 P - instruções de montagem



R	3,5 x 40
P	
	121 374
	32 x

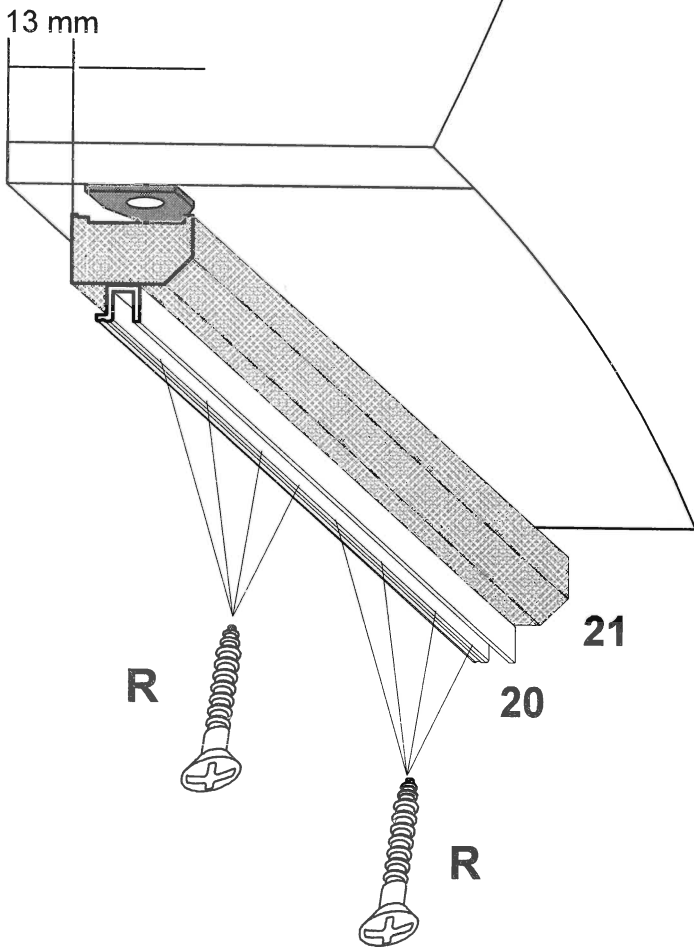
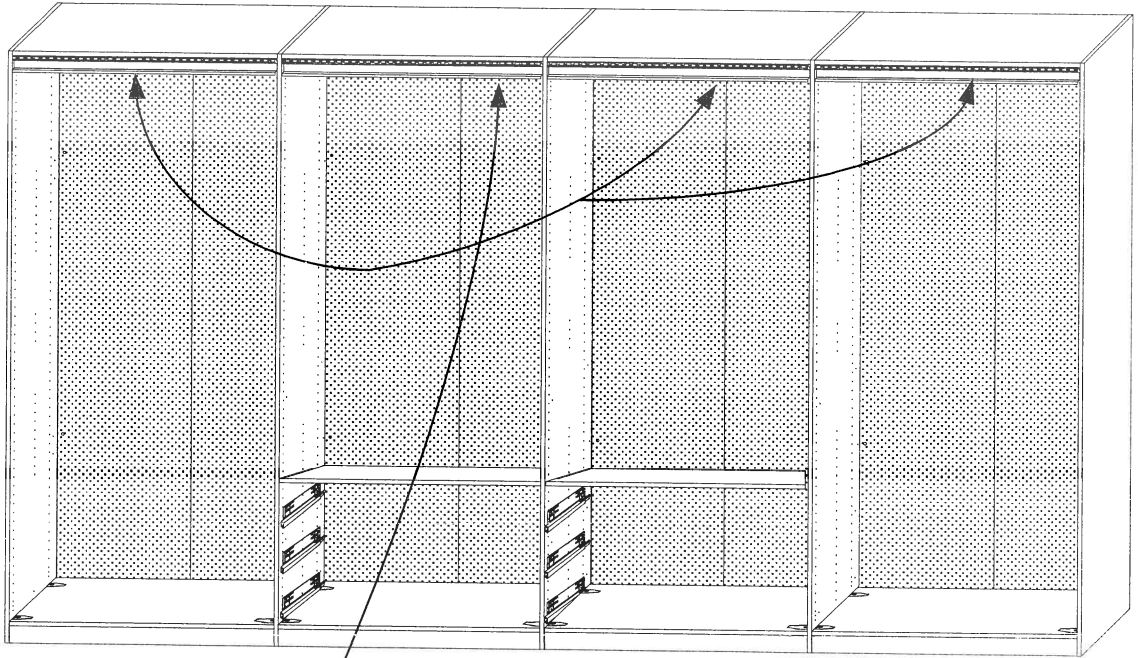

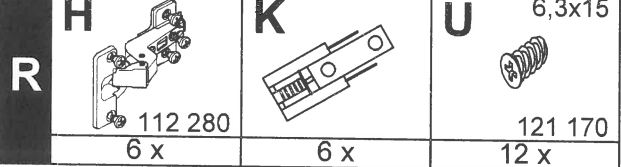
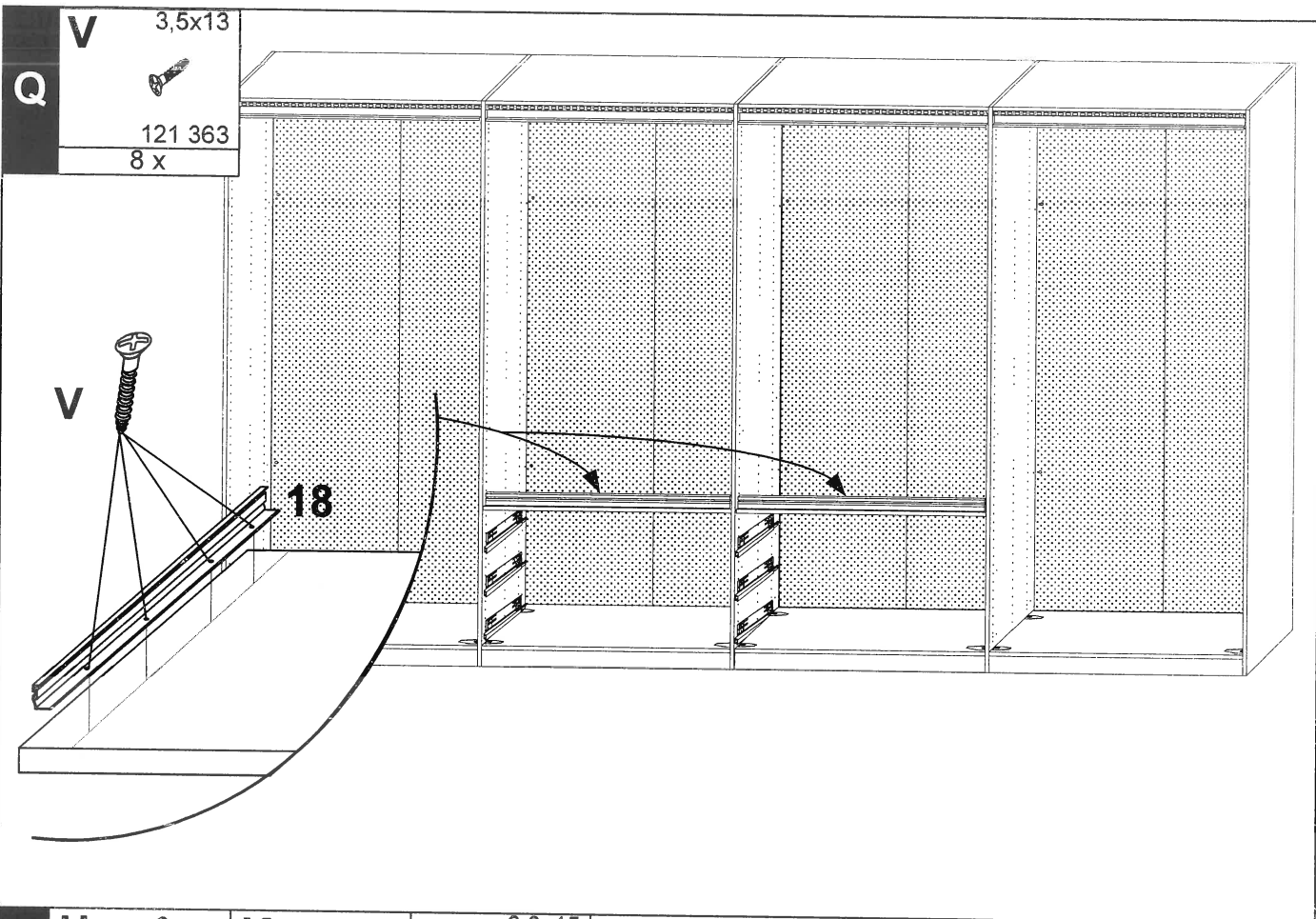



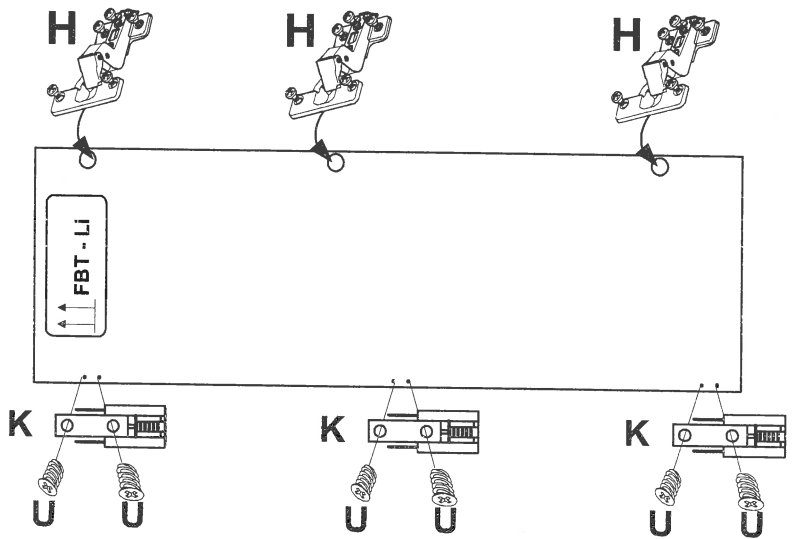

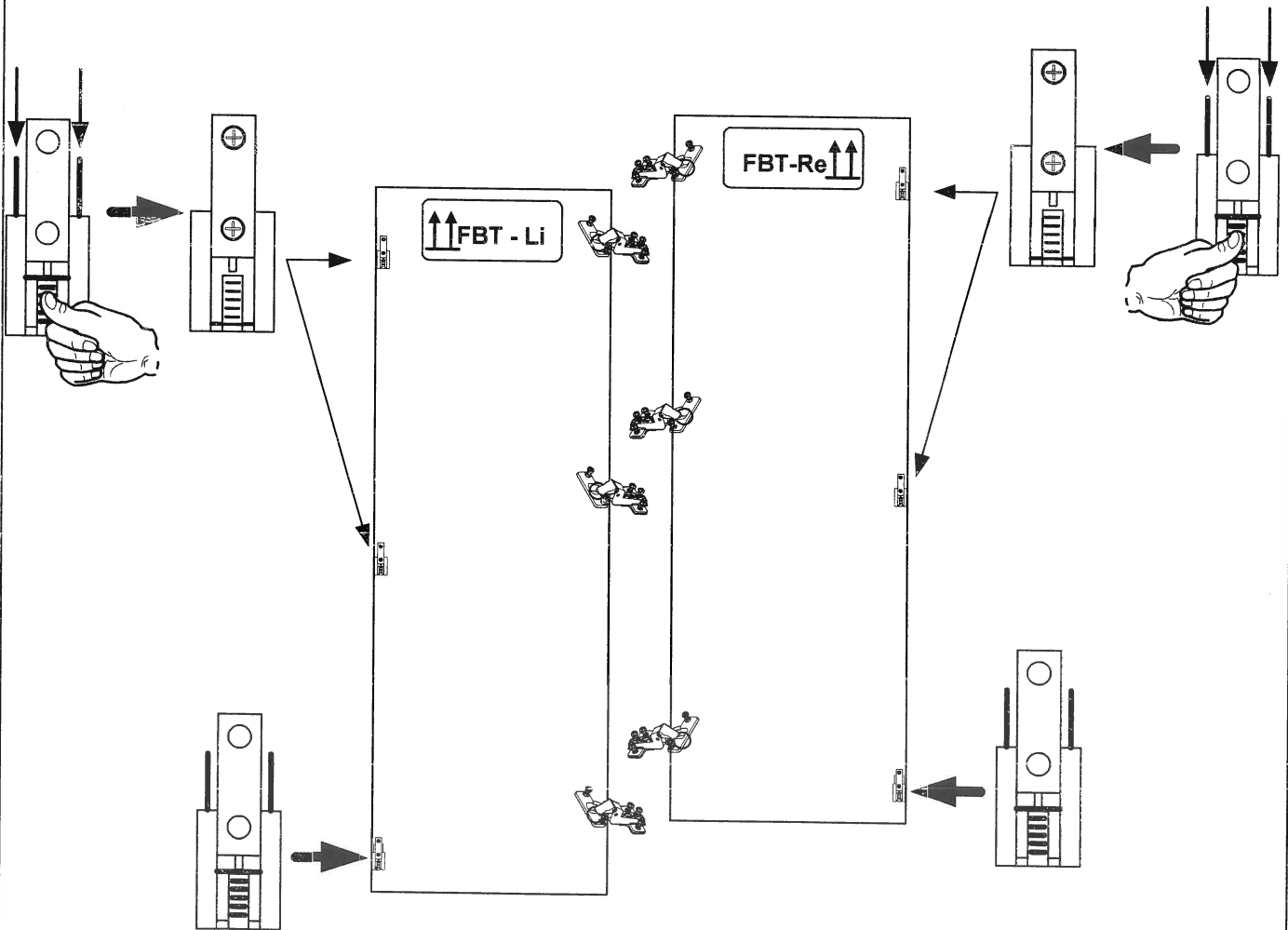
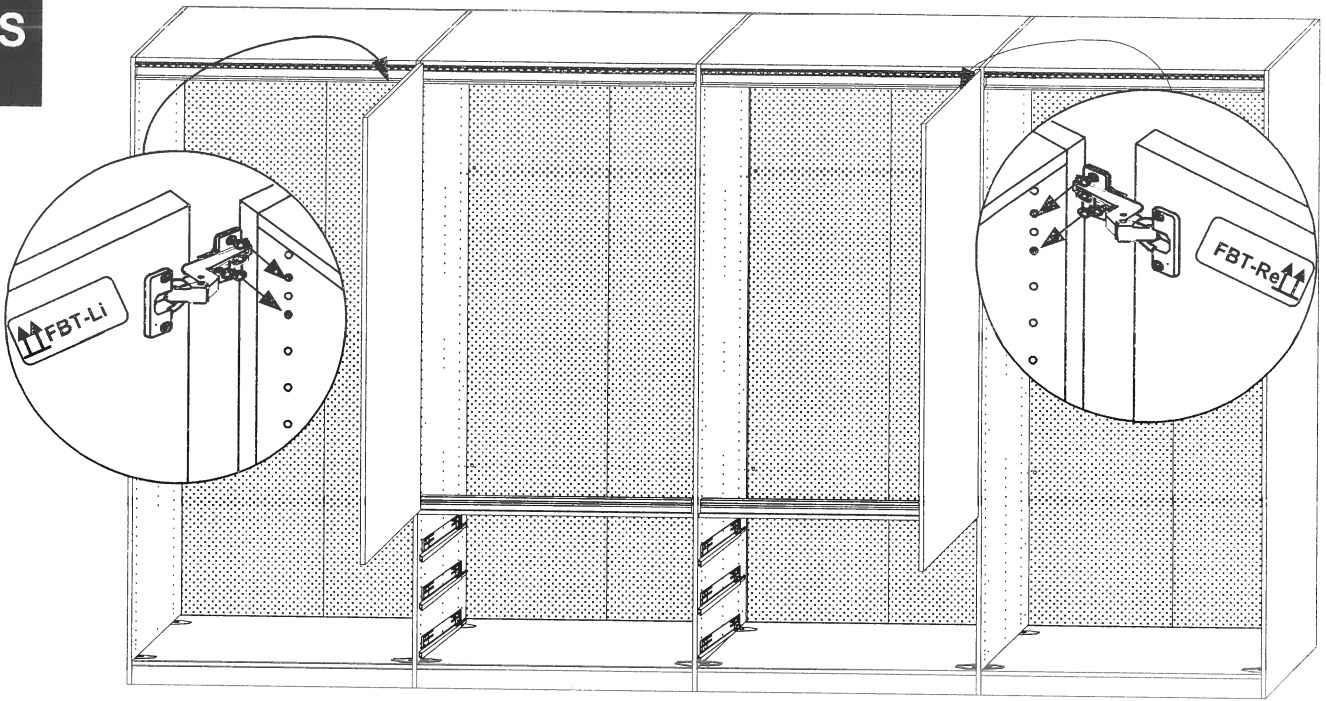



↑↑FBT-Li & ↑↑FBT-Re



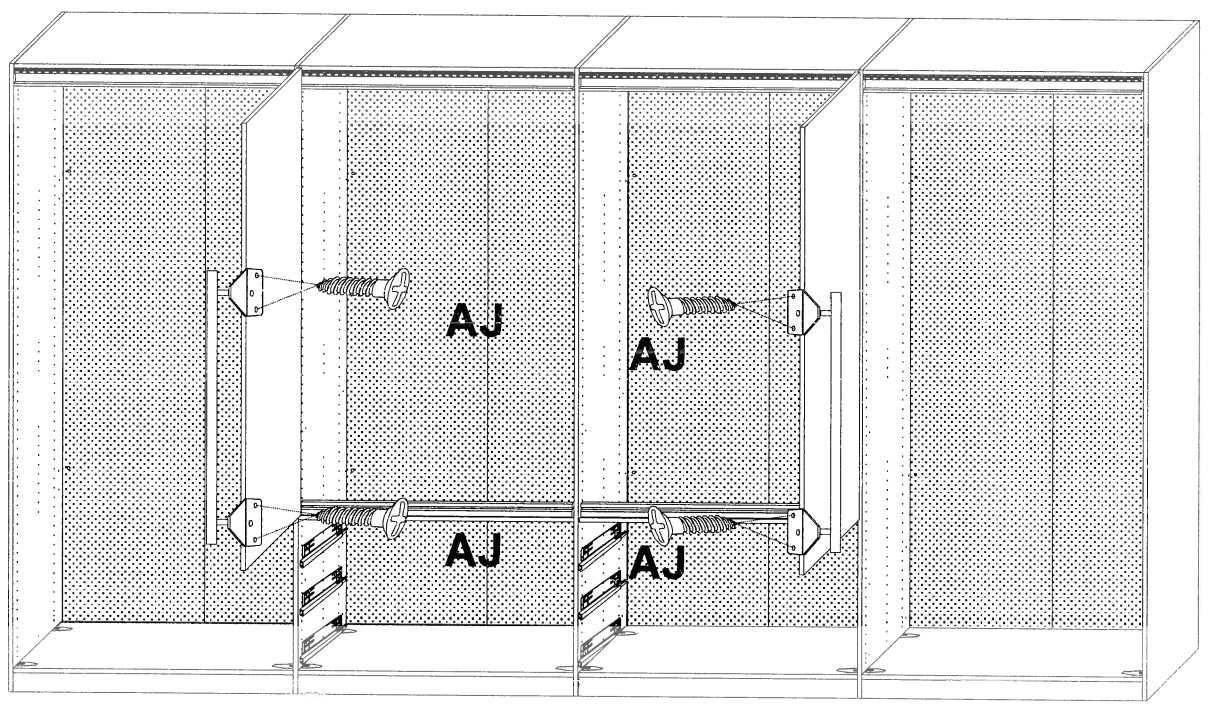
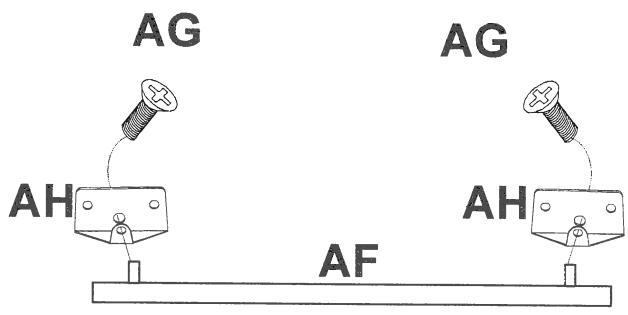

T	AF	AG M4 x 8	AH	AJ 3,5x15
		 122 618	 115 982	 121 503
	2 x	4 x	4 x	8 x

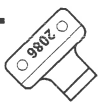

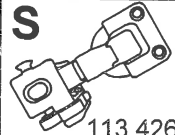
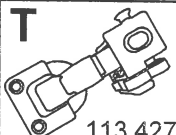
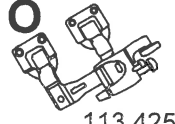
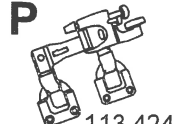
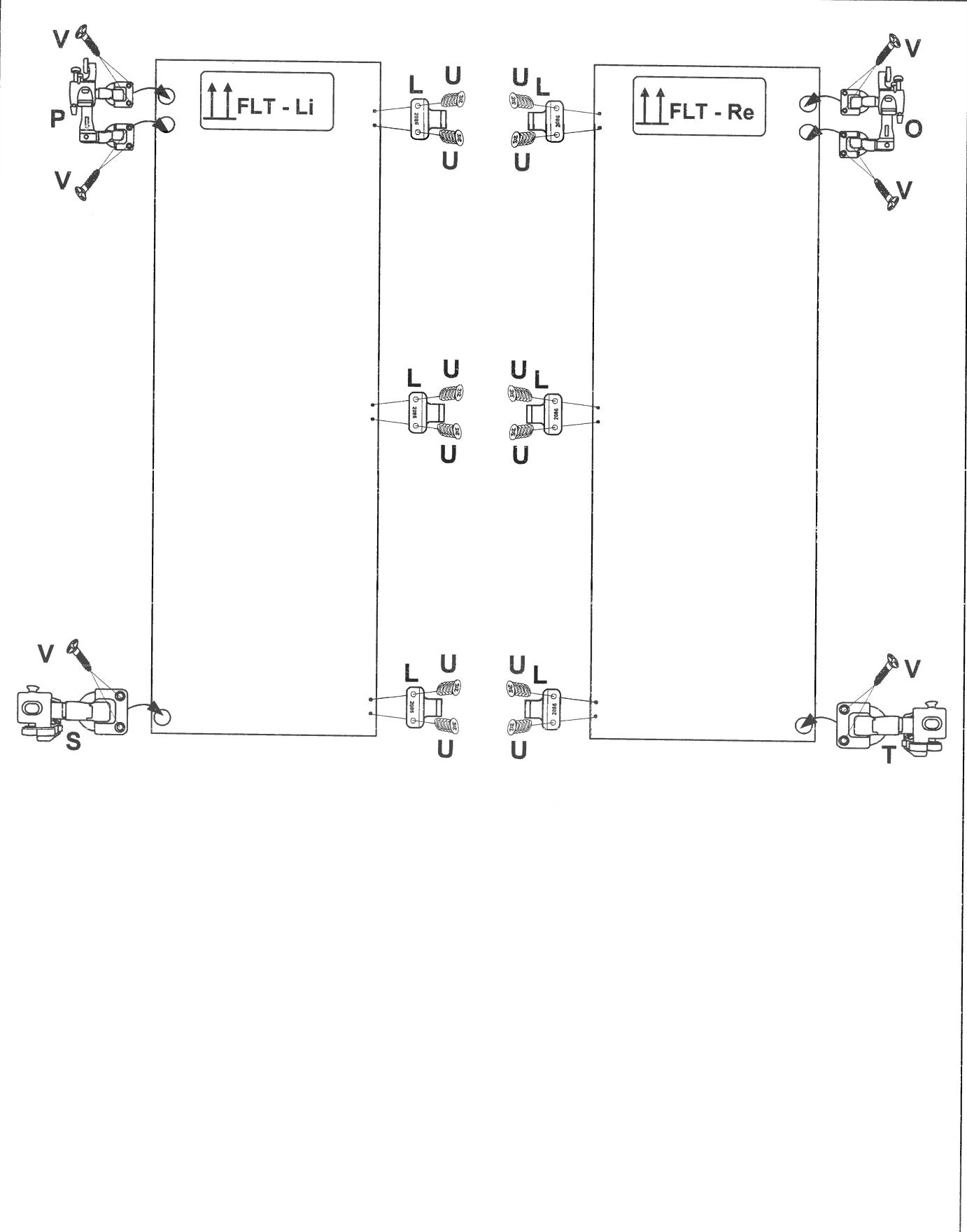
U	V 3,5x13  121 367 16 x	L  113 423 6 x	U 6,3x15  121 170 12 x	S  113 426 1 x	T  113 427 1 x	O  113 425 1 x	P  113 424 1 x
							
	991916 MA DTS FUK 3+4ZG LOFT 50-100CM ZG150CM Seite 70-97.VSD Geändert: 01.06.2017 Seite 83 von 125						

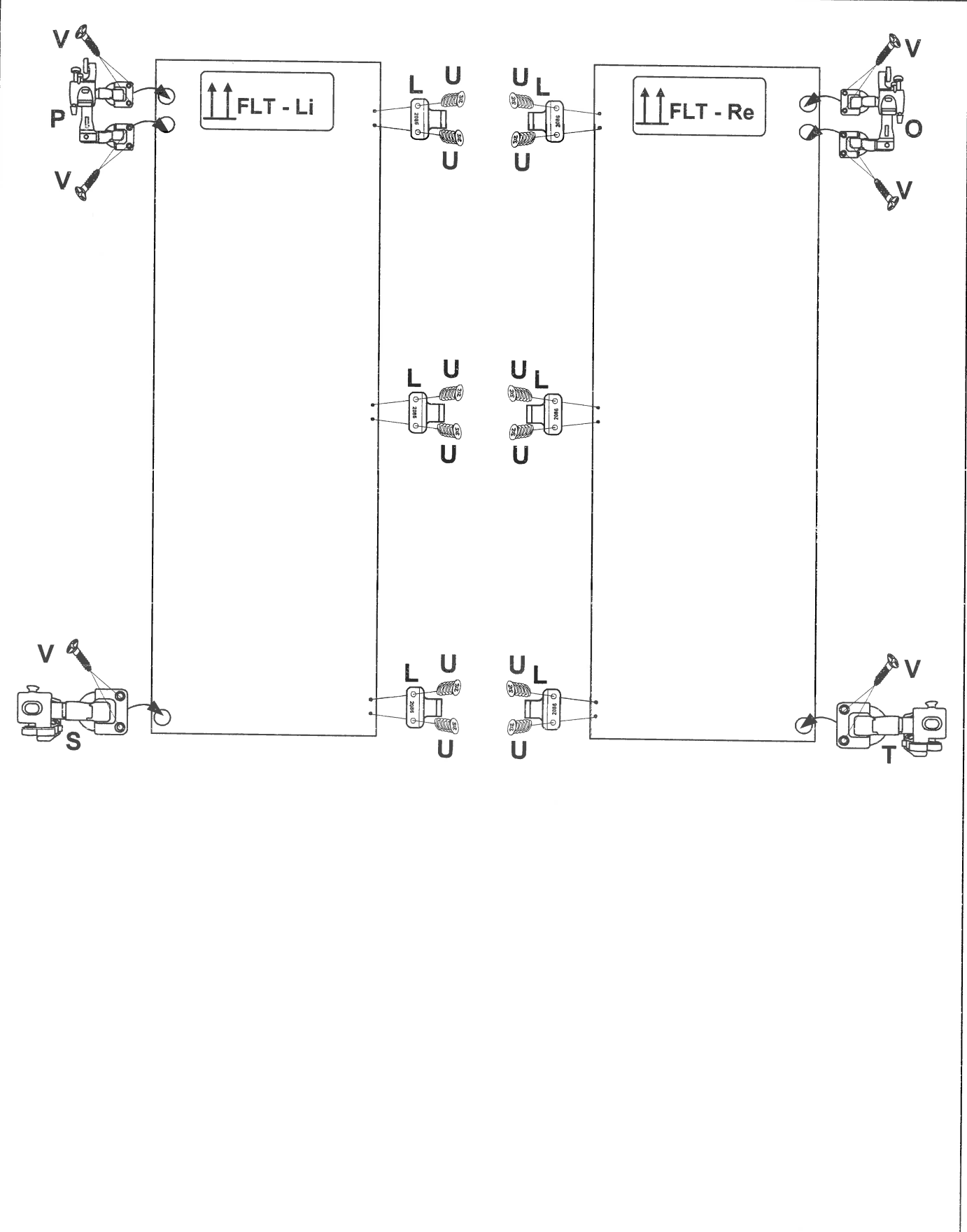

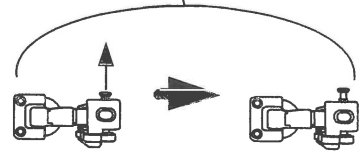
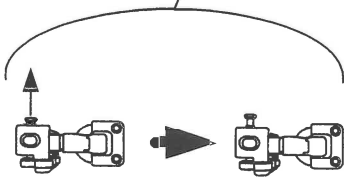
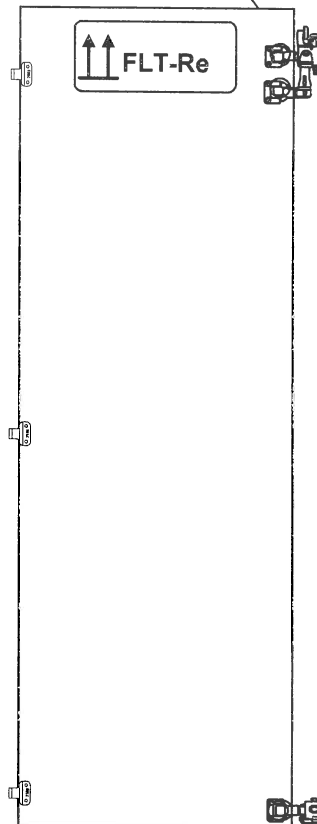
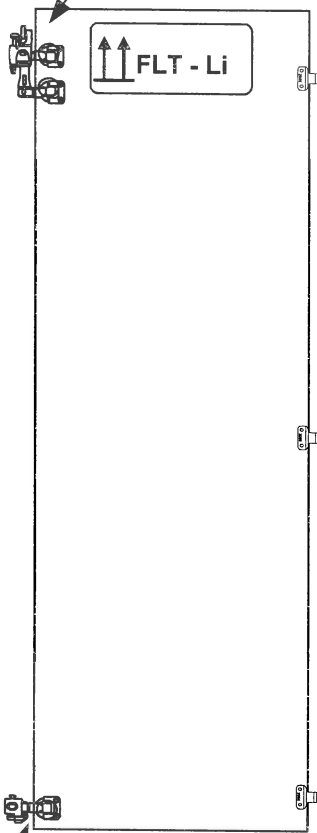
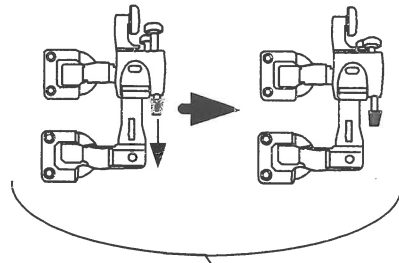
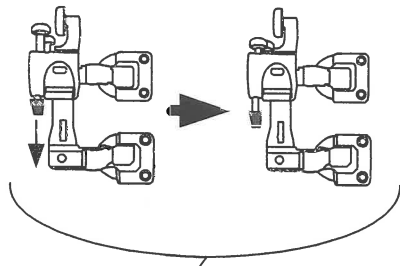

W

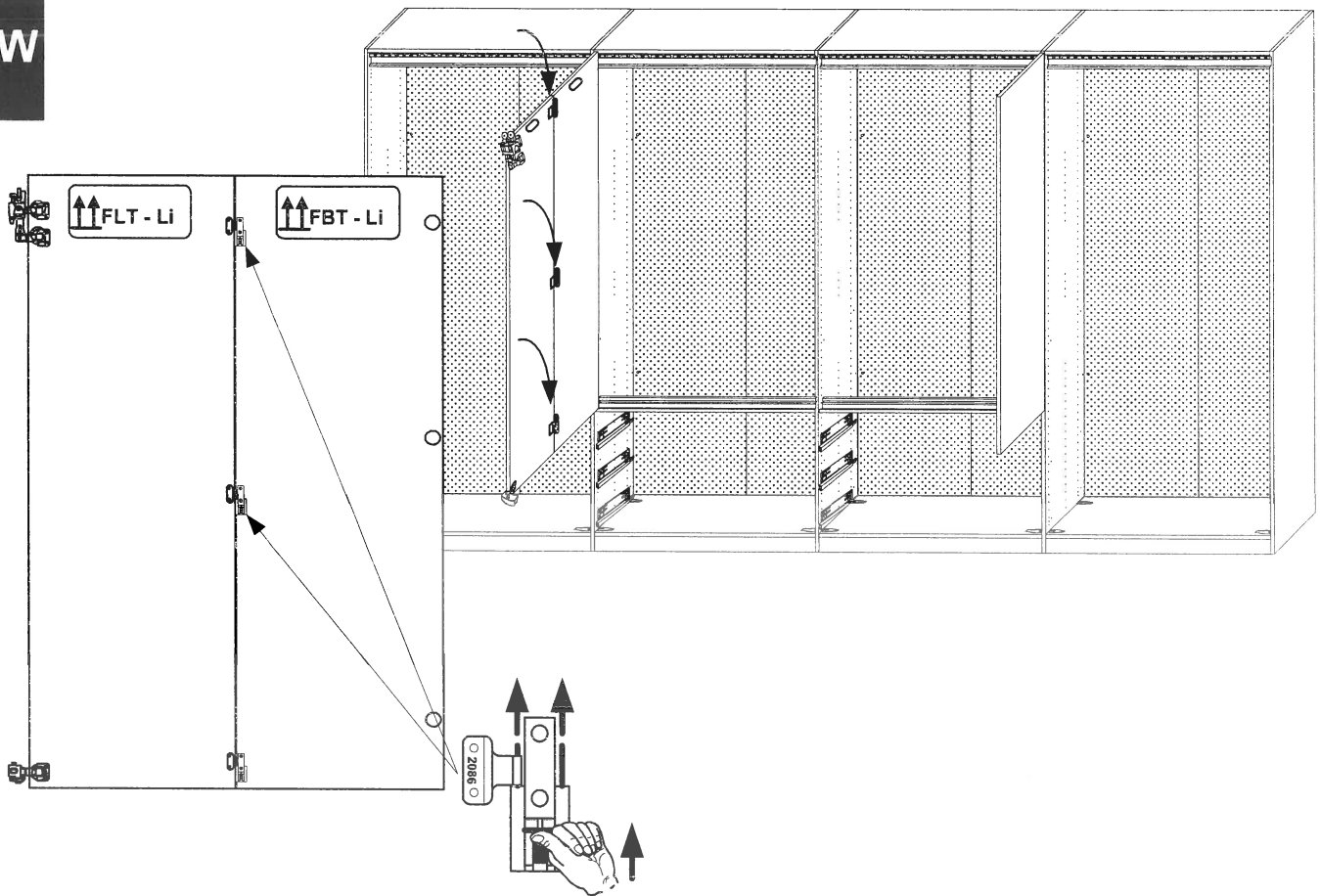

X

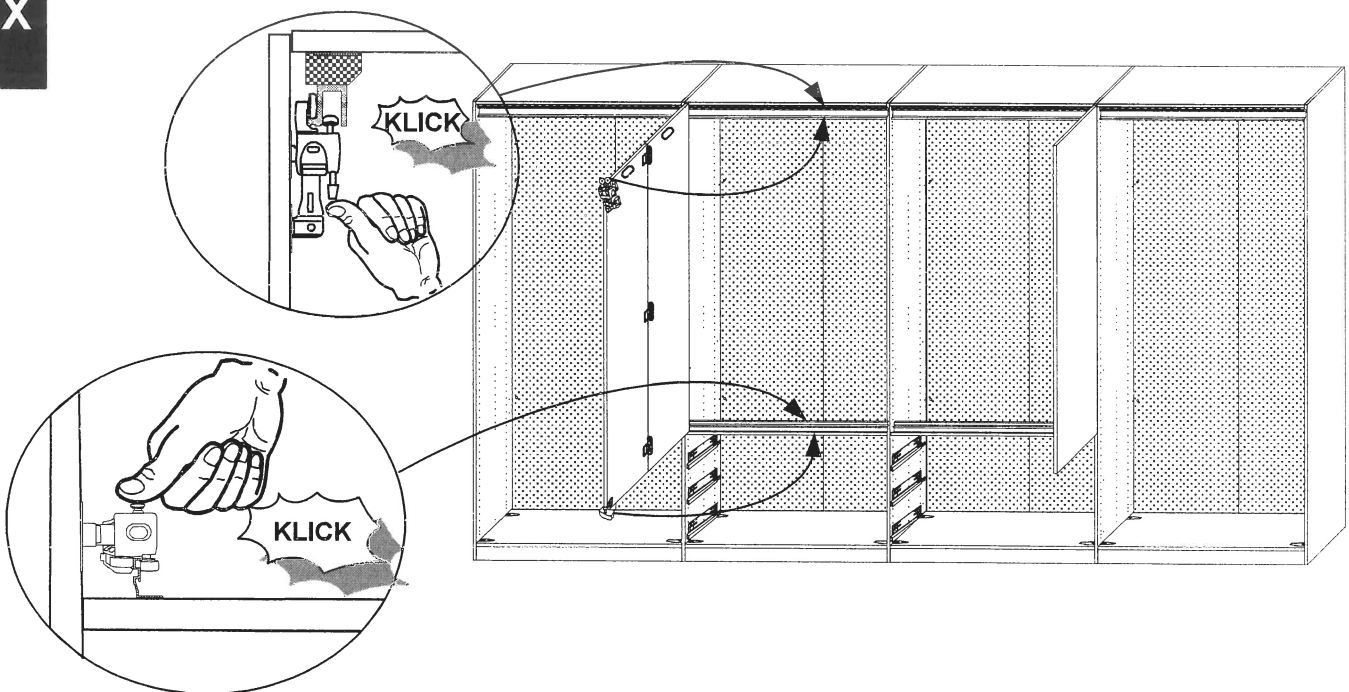



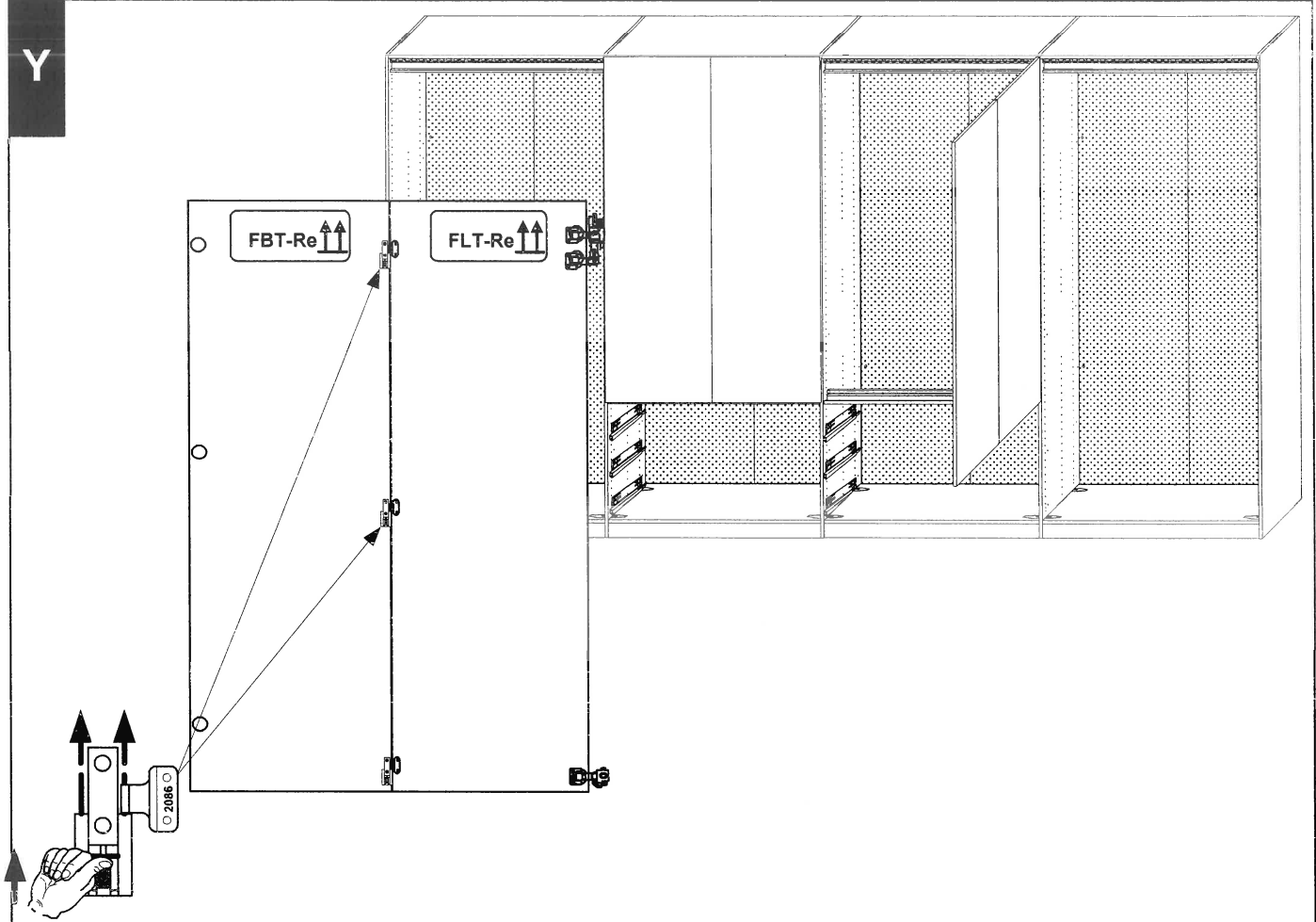

Y

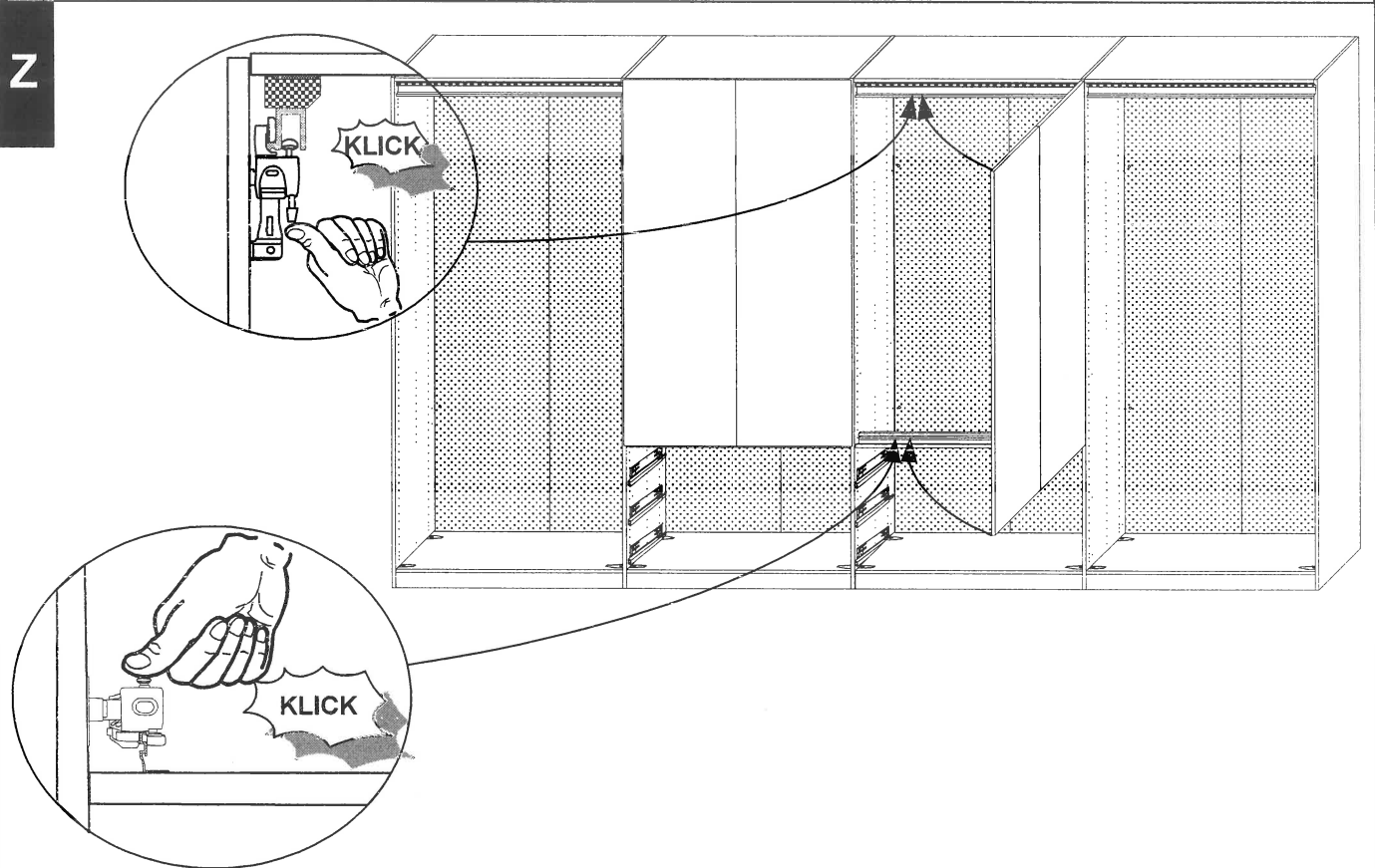

Z



**A
A**

X E4012  113 444 4 x	E 3,5x15  121 370 4 x	N  113 428 4 x	V 3,5x13  121 367 4 x
--	---	---	---

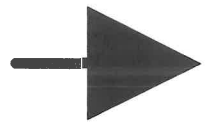
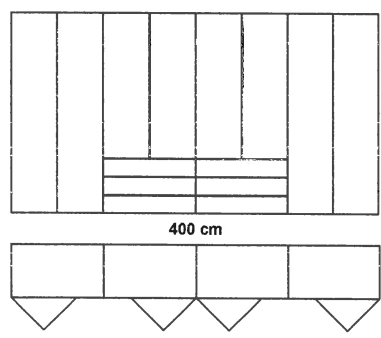
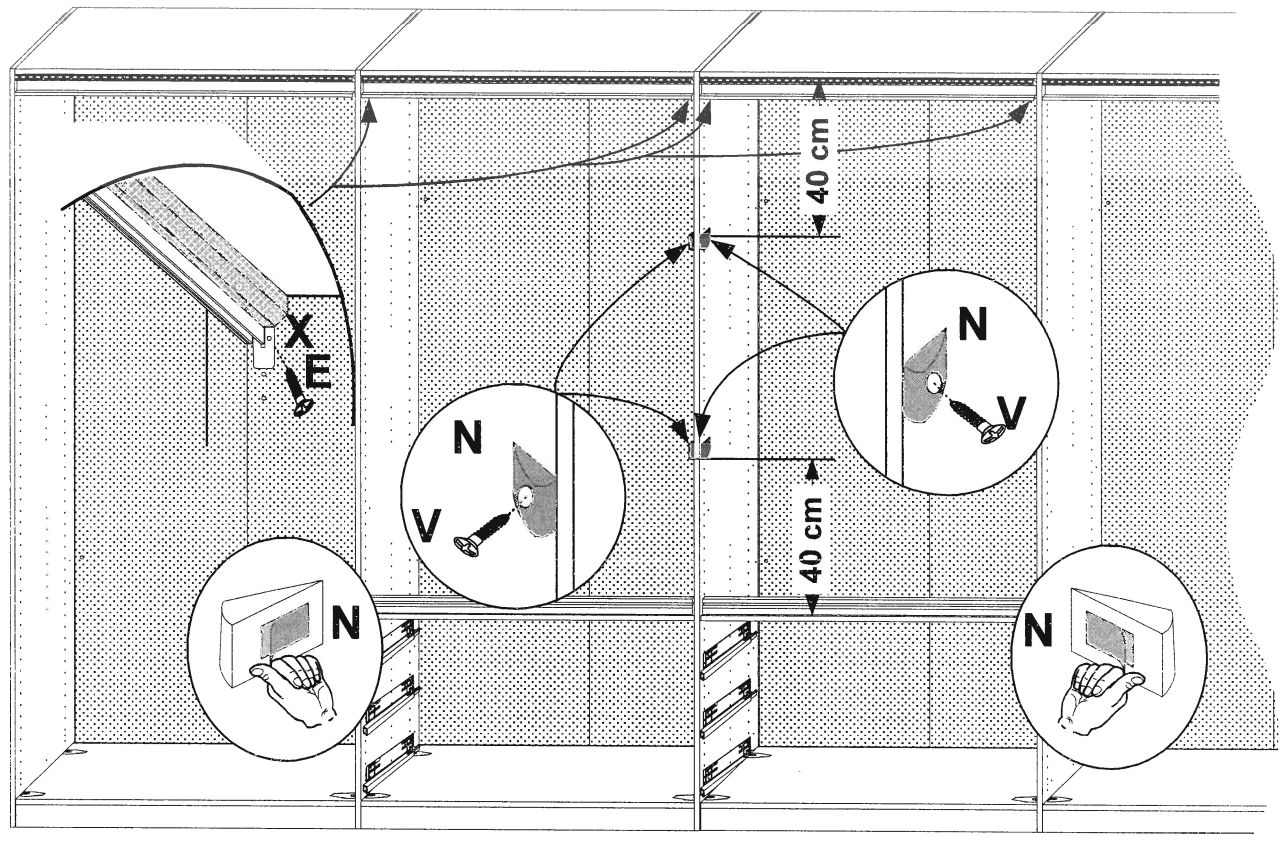

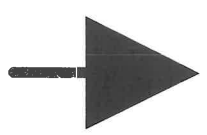
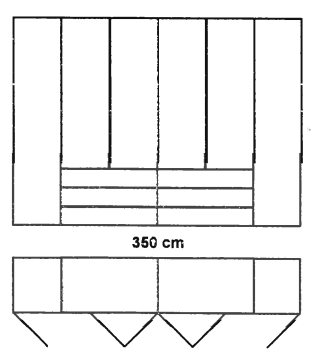

**A
B**

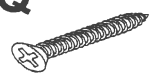

**A
M**

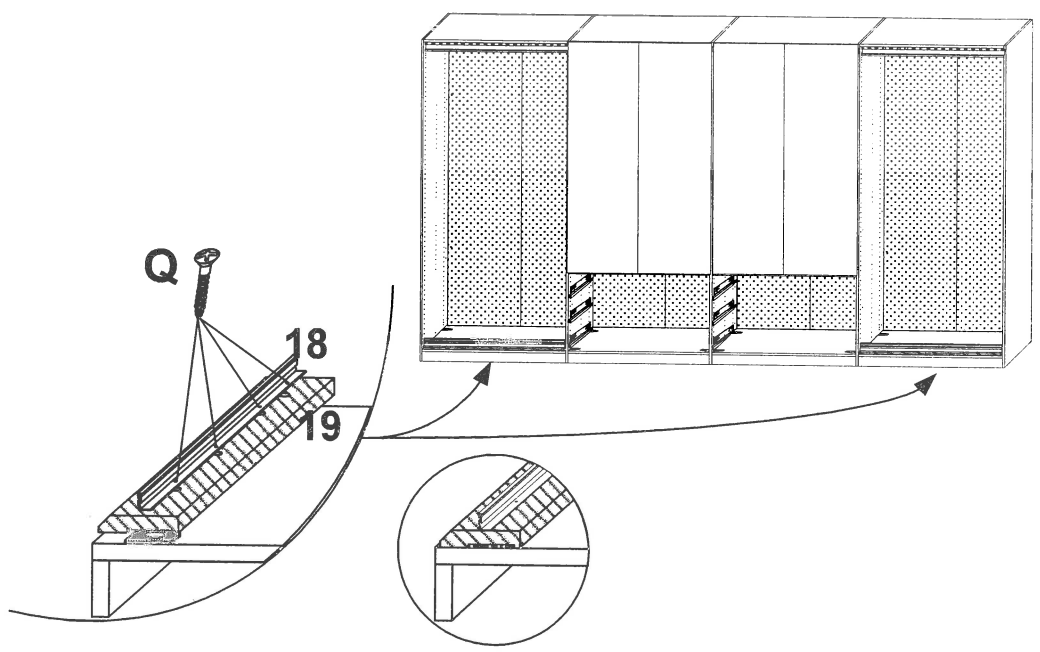
A **Q** 3,5 x 30
B 
 121 355

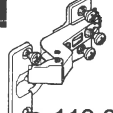



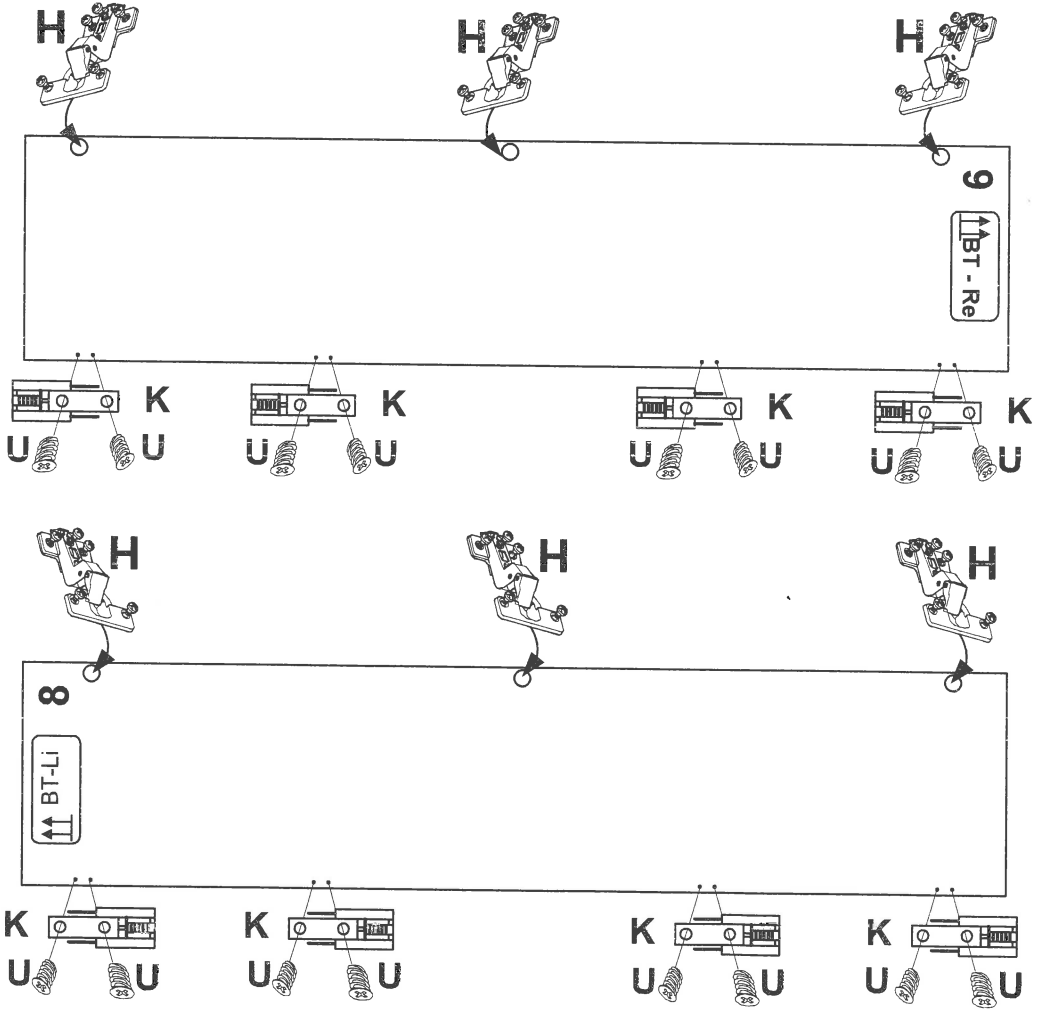

A C	H 	K 	U 6,3x15 
	112 280 6 x	113 422 8 x	121 170 16 x

 & 

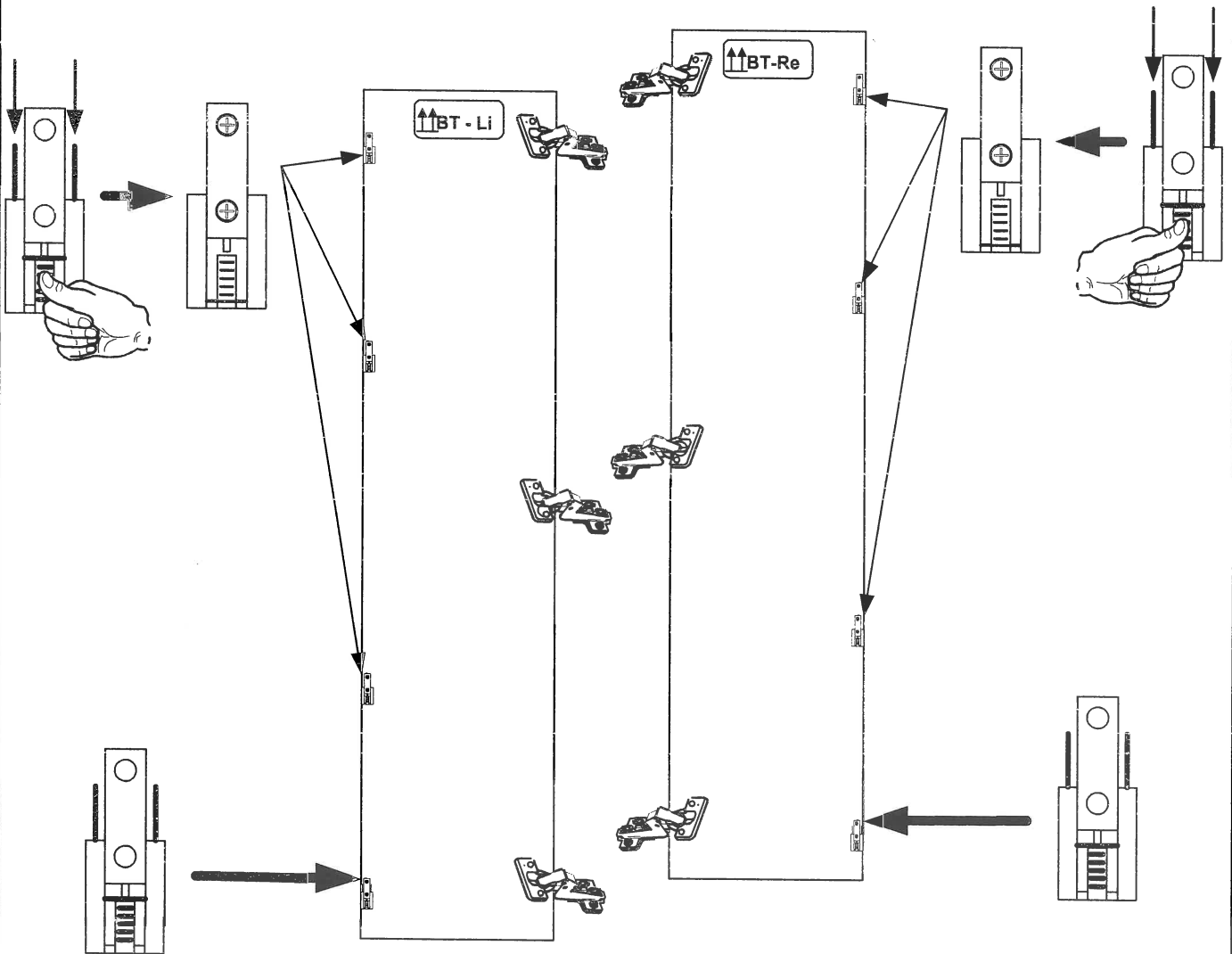
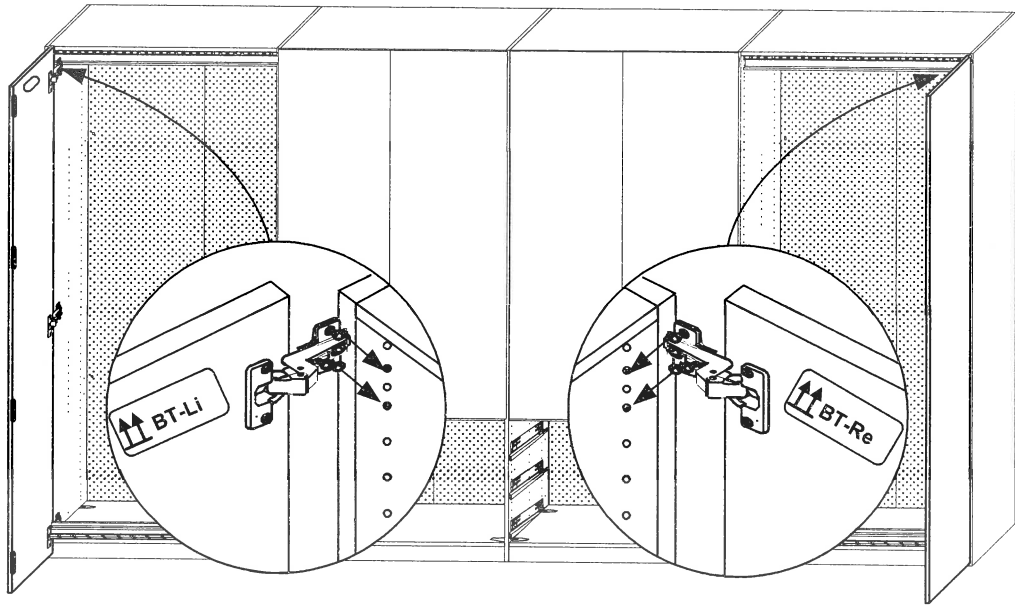





A
D

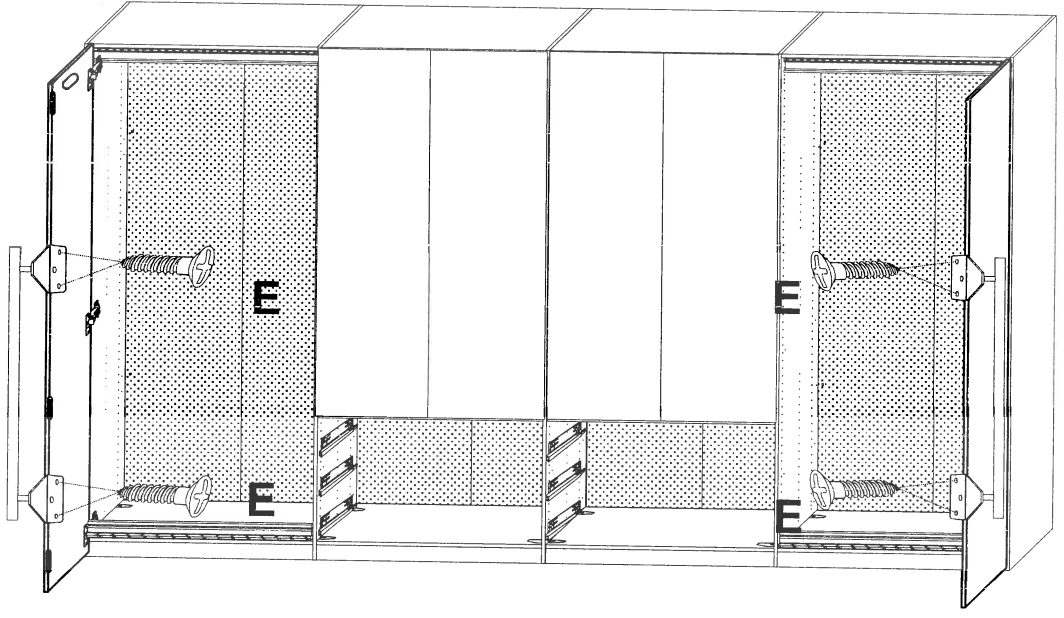
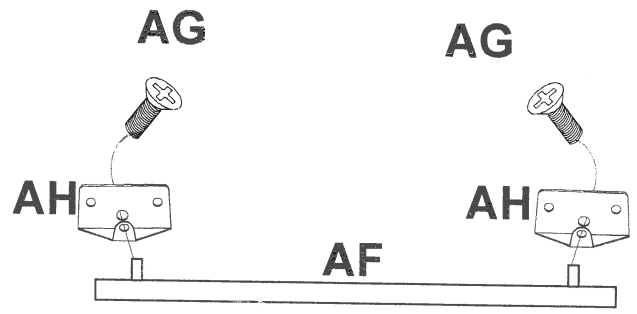

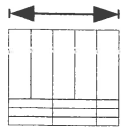
A E	AF	AG M4 x 8	AH	E 3,5x15
				
	2 x	122 618 4 x	115 982 4 x	121 370 8 x

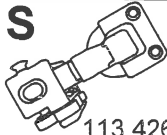
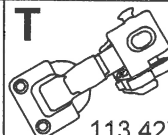
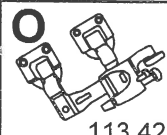
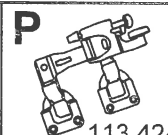

A F		L  113 423	U  6,3x15 121 170	S  113 426	T  113 427	O  113 425	P  113 424
	ca. 400 cm	8 x	16 x	1 x	1 x	1 x	1 x

V  3,5x13 0 - 12 x

↑↑LT-Li

&

↑↑LT-Re

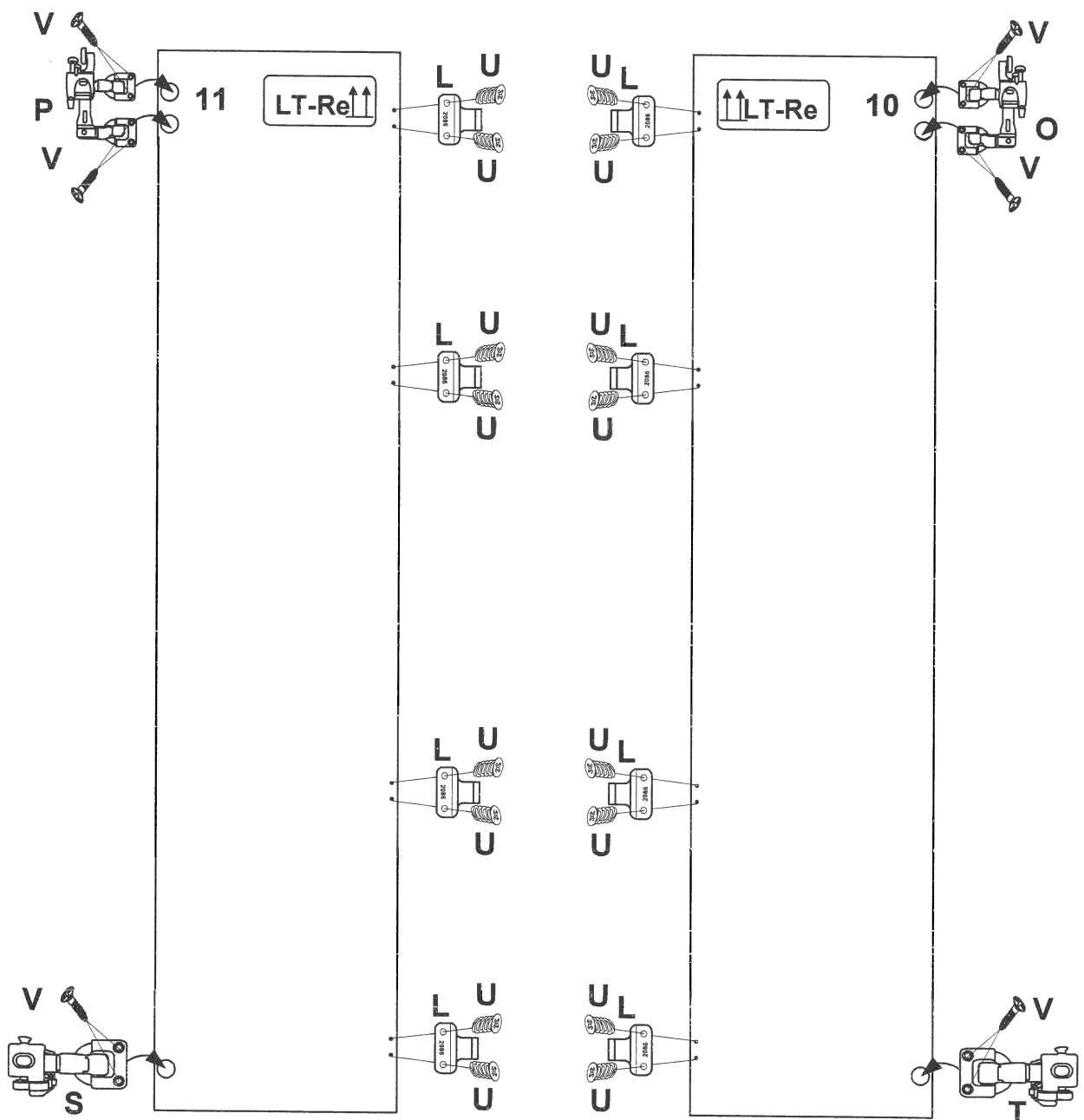

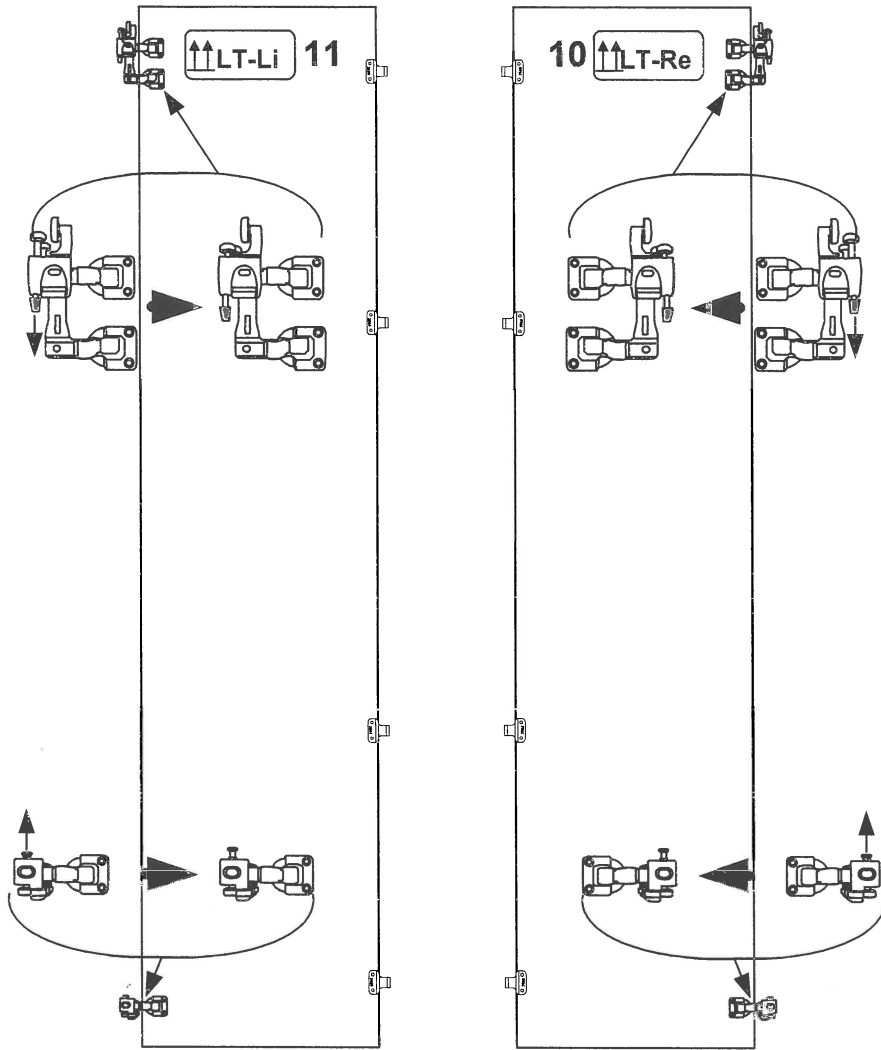

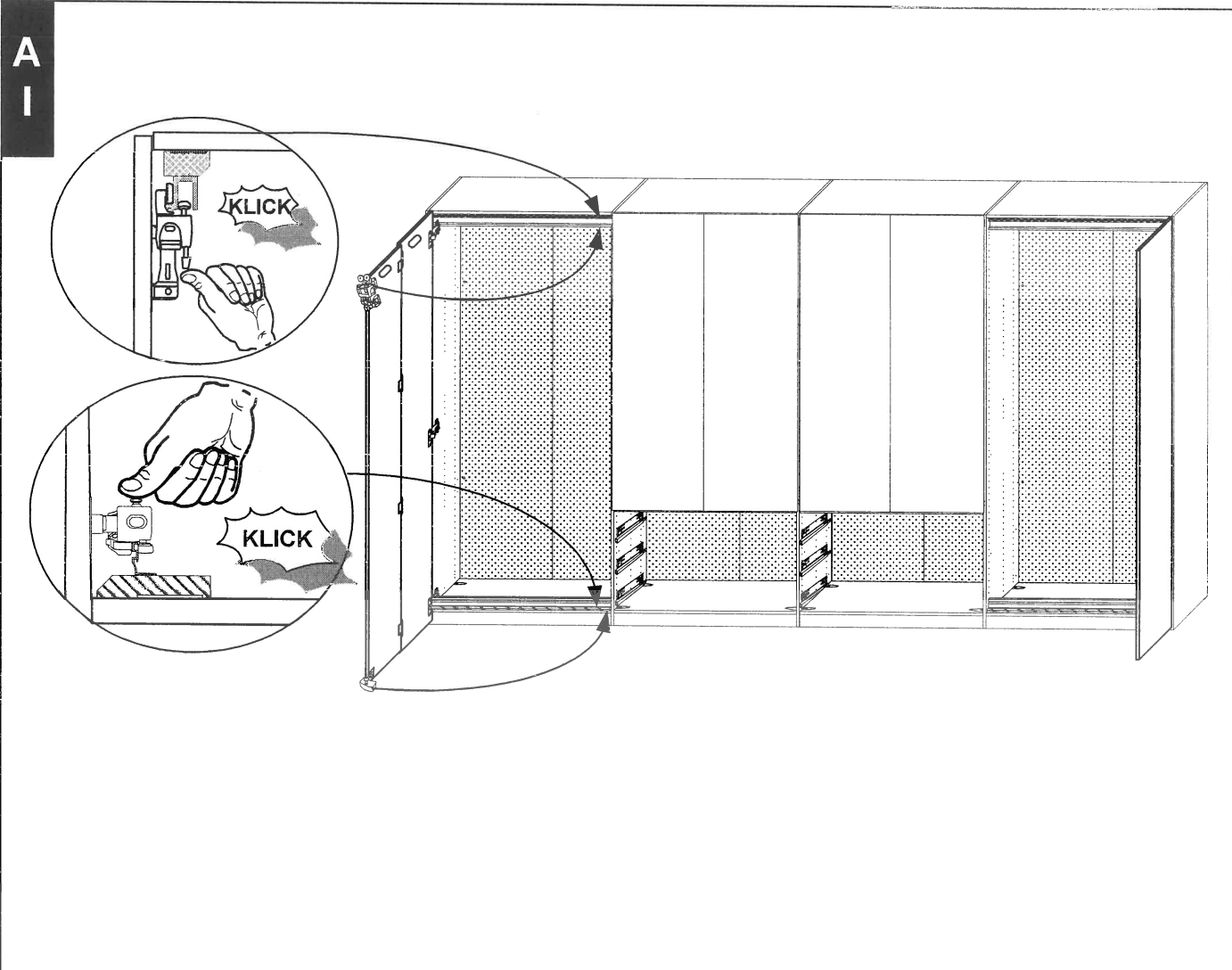
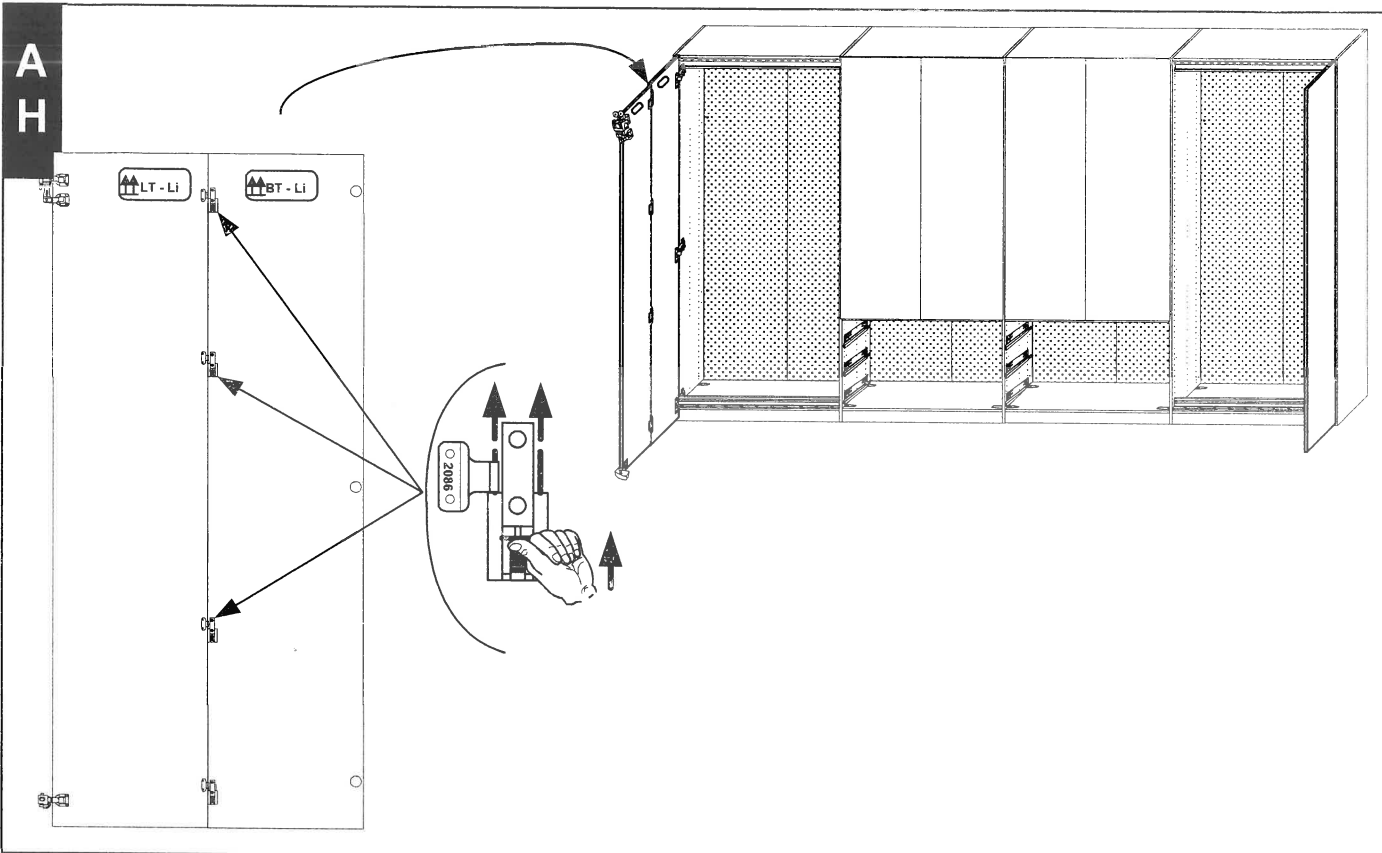



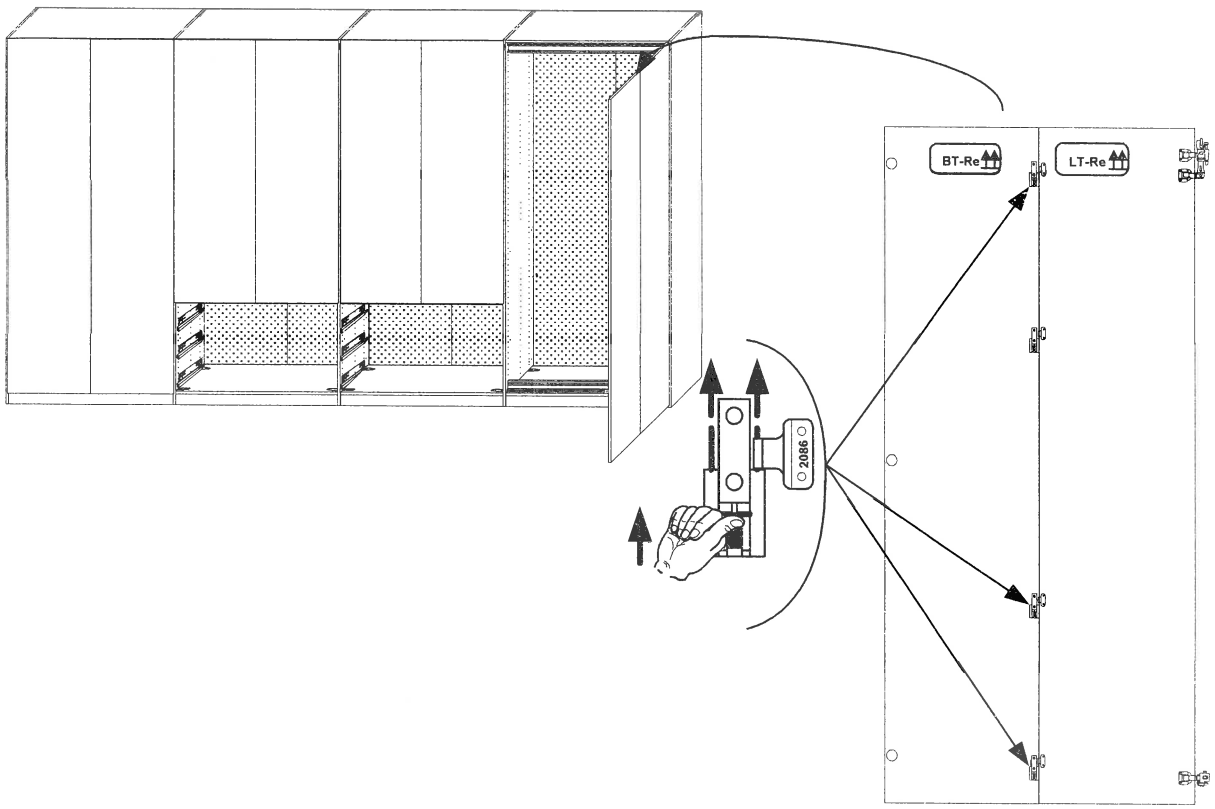

A
J

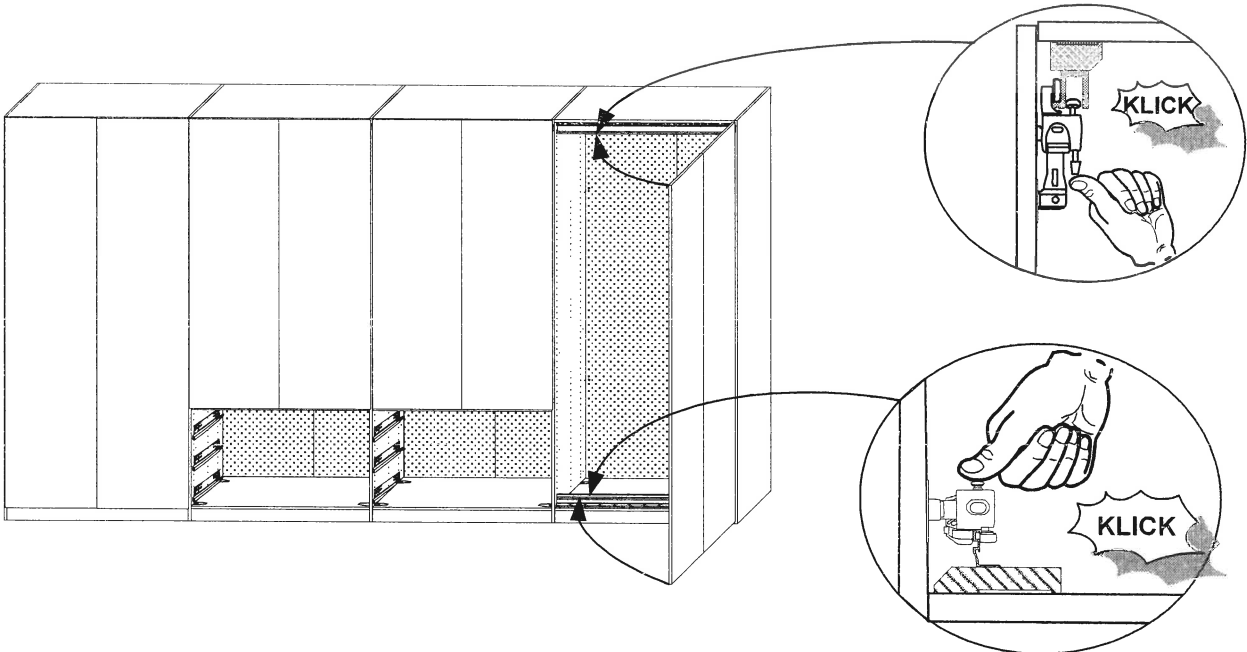

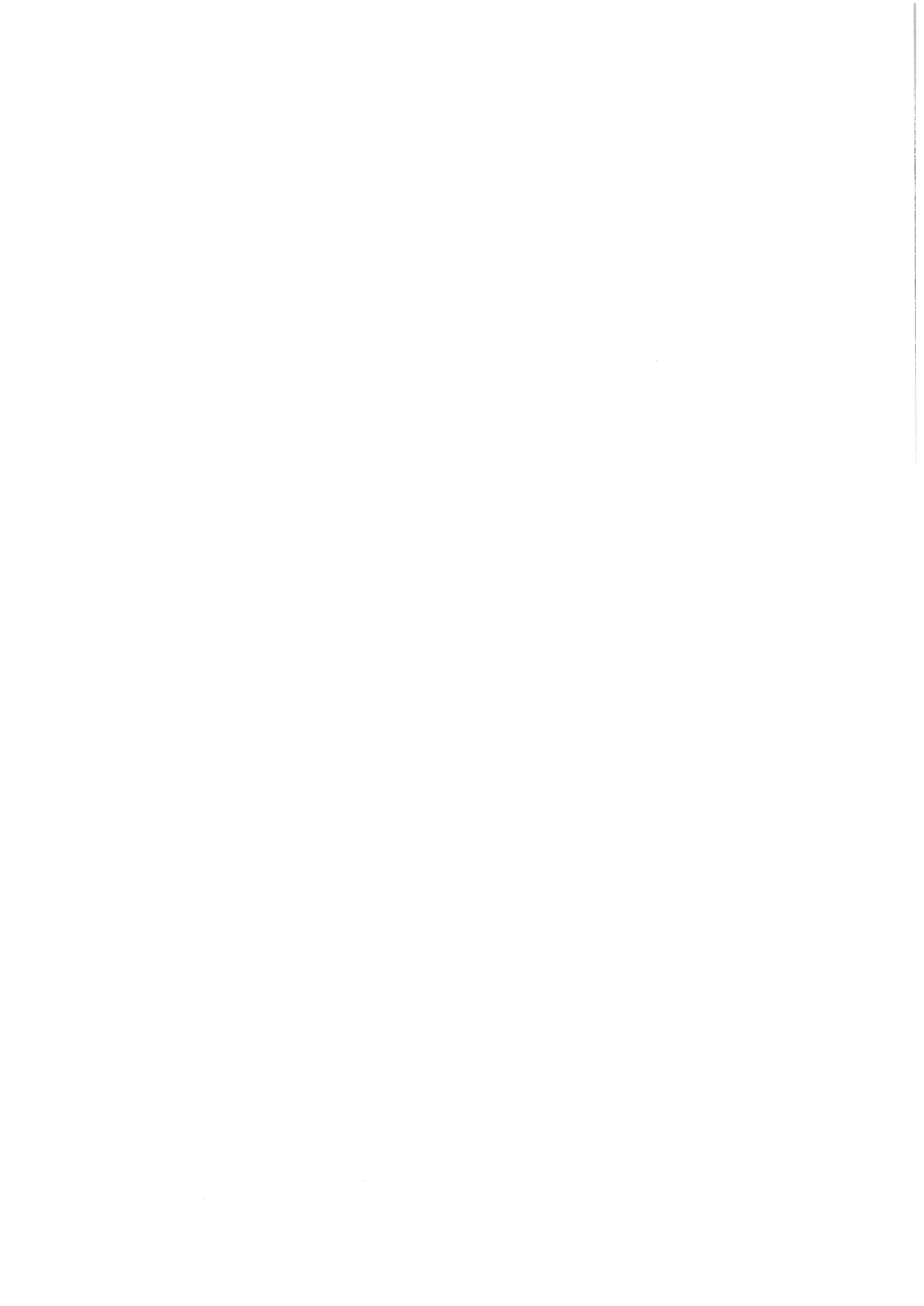

A
K



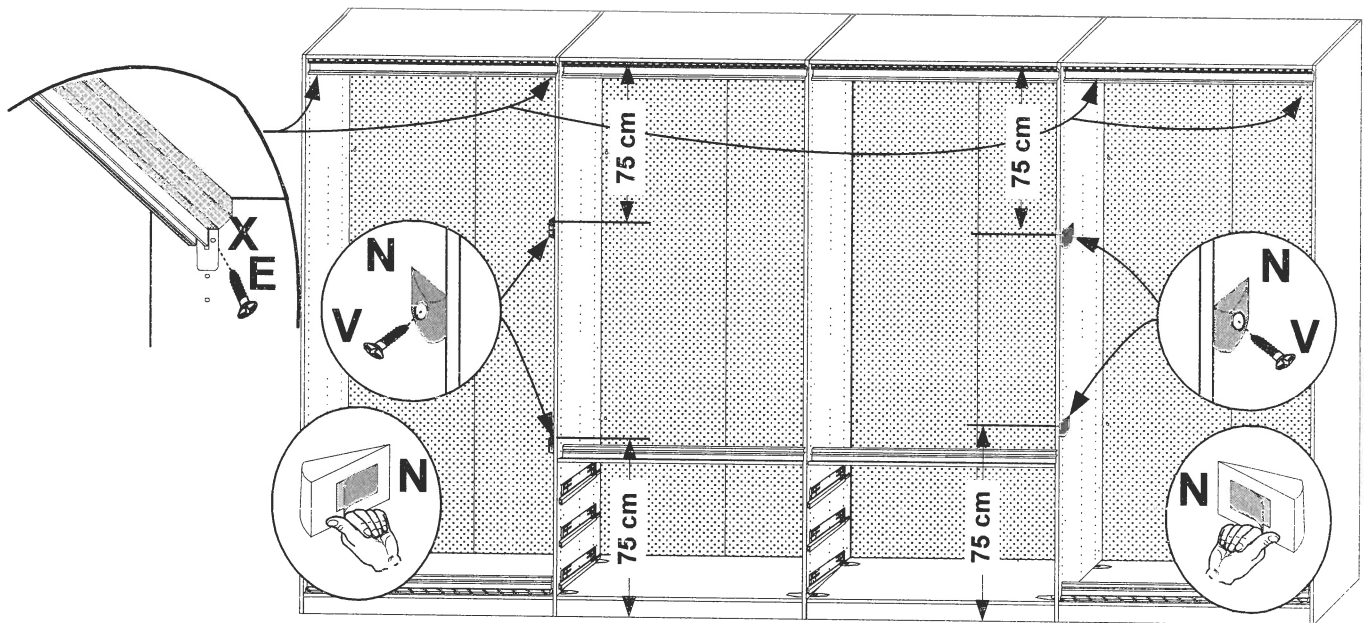

A L	X E4012	E 3,5x15	N	V 3,5x13
				
	113 444 4 x	121 370 4 x	113 428 4 x	121 367 4 x

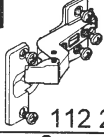

A M	H	W
		
	112 280 6 x	112 300 2 x

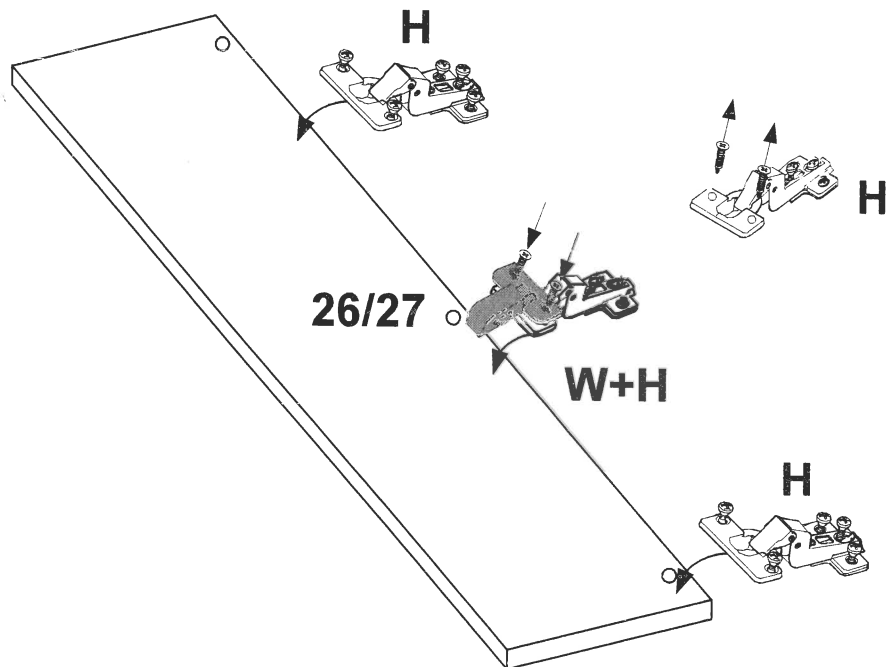

**A
N**

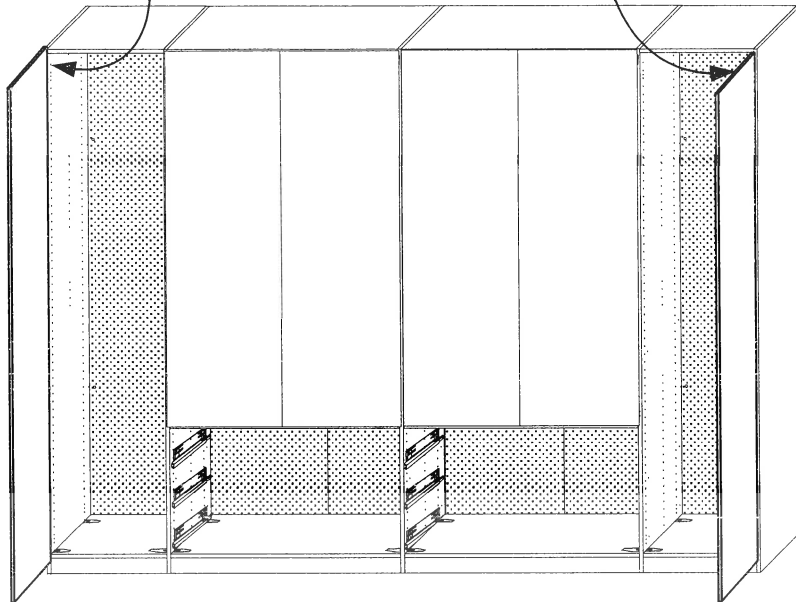
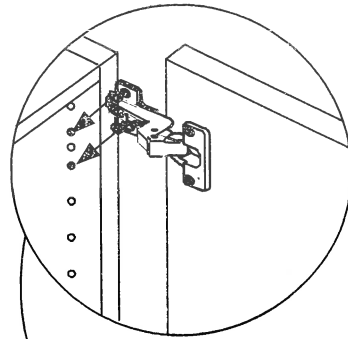
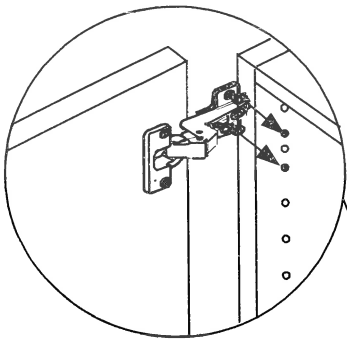

**A
O**

E

3,5x15



121 370

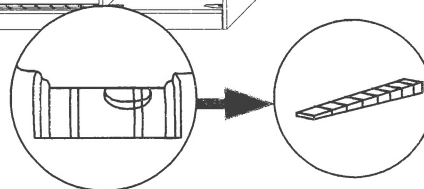
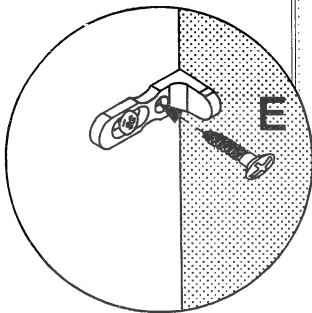
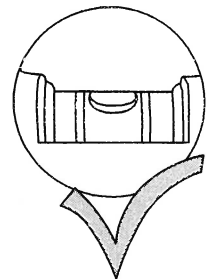
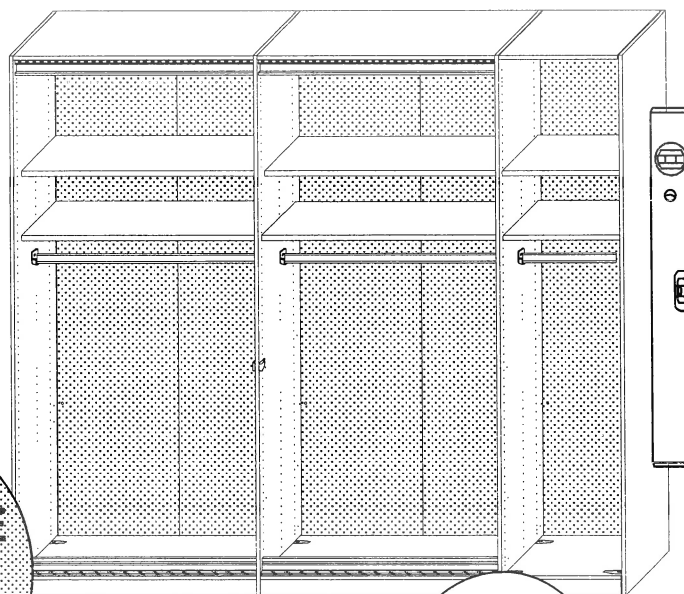

**A
P**

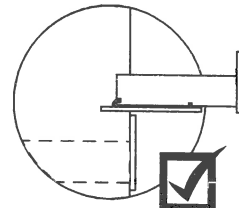
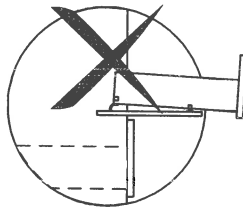
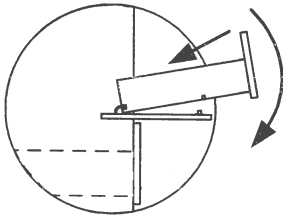
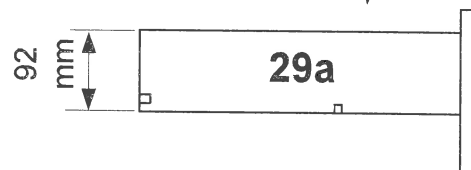
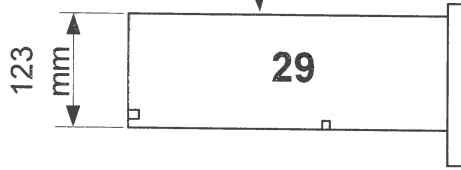
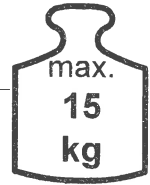
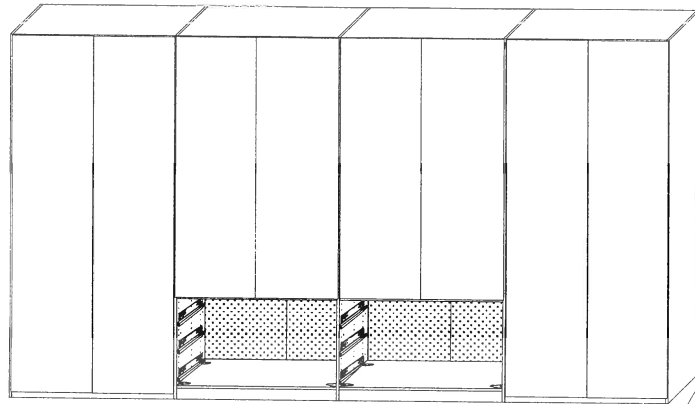
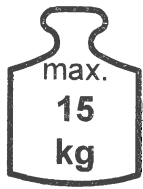

**A
Q**

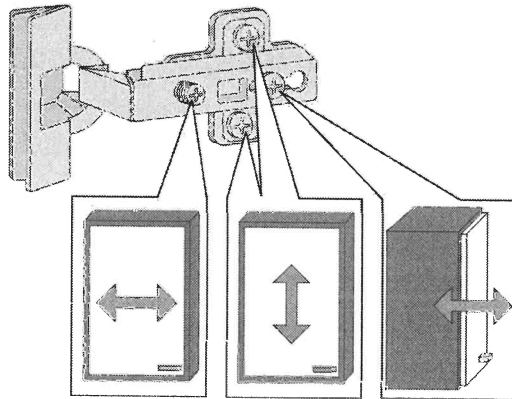

**A
R**

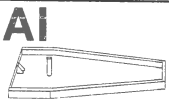

111 265

