

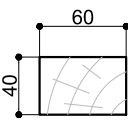

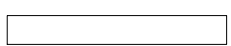

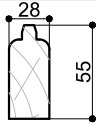





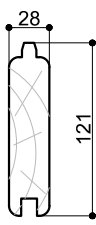

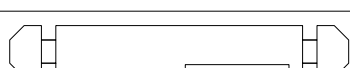
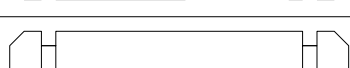
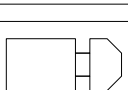

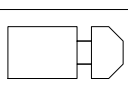
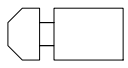

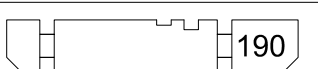
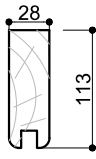
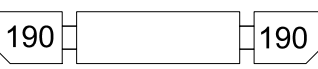
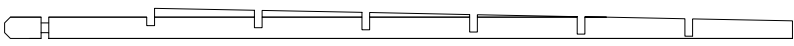

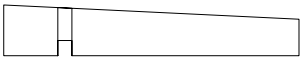

Dim.	Skizze, Dessin, Sketch	Pos.	Länge, Longueur, Length, mm	Stck/ Qté.	Name, Nom, Name	Ref.
		Ⓐ	3120	2	Fundamentbalken Lambourdes Foundation beam	283065
		Ⓑ	2400	4	Fundamentbalken Lambourdes Foundation beam	283080
		①	3300	2	Front, zurück Brett Madrier avant, arrière Front, back board	280010
		②	5100	18	Seiten Brett Madrier latéral Side board	280013
		②a	5100	1	Seiten Brett Madrier latéral Side board	280153
		②b	5100	1	Front, zurück Brett Madrier avant, arrière Front, back board	280157
		③	3300	20	Front, zurück Brett Madrier avant, arrière Front, back board	280012
		④	442	34	Front Brett Madrier avant Front board	280011
		⑤	3833	10	Seiten Brett Madrier latéral Side board	280156
		⑥	442	16	Seiten Brett Madrier latéral Side board	280011
		⑥a	857	7	Seiten Brett Madrier latéral Side board	280154
		⑦	857	14	Seiten Brett Madrier latéral Side board	280155
		⑧	5200	2	Seiten Brett Madrier latéral Side board	280195
		⑨	3500	2	Front, zurück Brett Madrier avant, arrière Front, back board	281047
		⑩	3446	2	Seiten Brett Madrier latéral Side board	282042

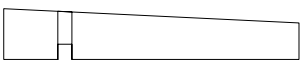
3/12

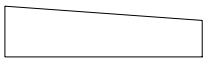
→ || ← 28mm

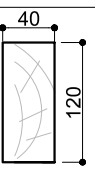

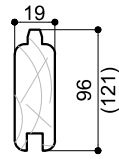
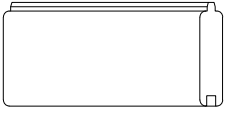
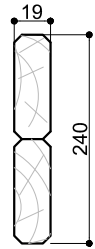
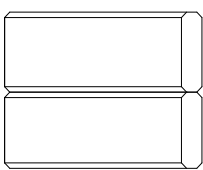
3,3 x 5,1

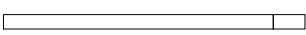
28210

		⑪	728	2	Seiten Brett Madrier latéral Side board	282043
		⑫	728	2	Seiten Brett Madrier latéral Side board	282044
		⑬	504	2	Seiten Brett Madrier latéral Side board	282045
		⑭	504	2	Seiten Brett Madrier latéral Side board	282046
		⑮	3500	8	Sparren Panne faîtière Rafters	284070
		⑯	2920	40 (32)	Dach Bretter Madrier de toit Roof board	284523
		⑯a	2360	40 (32)		284517
		⑰	3538	2	Wind Brett Planche de rive Wind board	285046
		⑰	2380	2		285047
		⑰a	2920	2		285048
		⑰	1835	1		287106

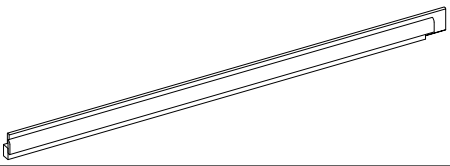
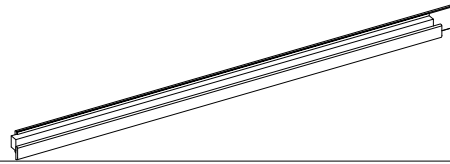
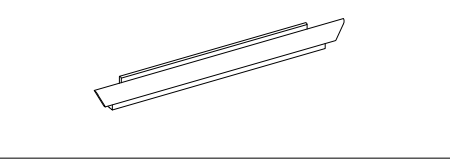
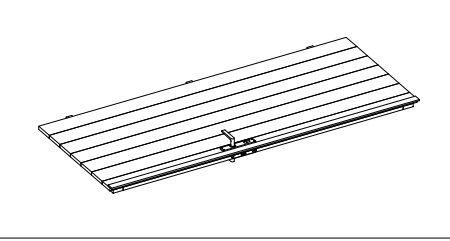
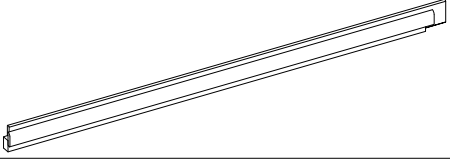
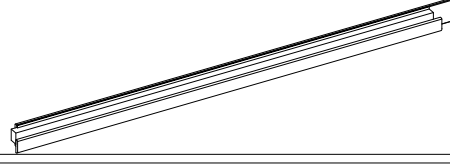
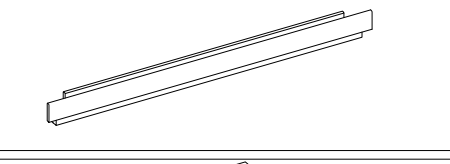
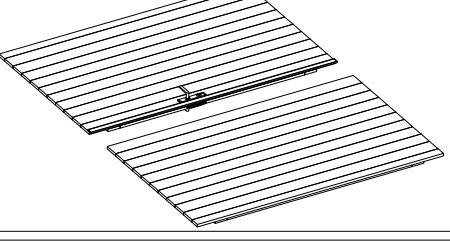
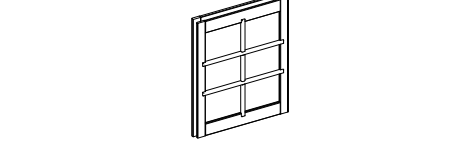
Alle maßen ca +/-3% / les dimensions des pièces peuvent évoluer +/- 3% / size tolerance +/- 3%

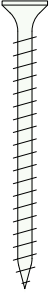
Skizze, Dessin, Sketch	Pos.	Länge, Longueur, Length,mm	Stck/ Qté.	Name, Nom, Name	Ref.
	TR1	1940	1	Türrahmen links Cadre de porte gauche Door frame left	289226
	TR2	1940	1	Türrahmen rechts Cadre de porte droite Door frame right	289227
	TR3	910	1	Über Türrahmen Montant supérieur Door frame top	289228
	T	1845x 760	1	Tür Porte Doors	289013
	GR1	1960	1	Türrahmen links Cadre de porte gauche Door frame left	289212
	GR2	1960	1	Türrahmen rechts Cadre de porte droite Door frame right	289213
	GR3	2405	1	Über Türrahmen Montant supérieur Door frame top	289214
	G1	1845x 1170	1	Tür Porte Doors	289009 G1
	G2	1845x 1170	1		289009 G2
	F	700x880	2	Fenster Fenêtre Window	289101

	Pos.	Dim	Qté.
		Ø5.0 x 100	8
		Ø3.5 x 40	100
		Ø3.0 x 25	4
		Ø2.0 x 40	450

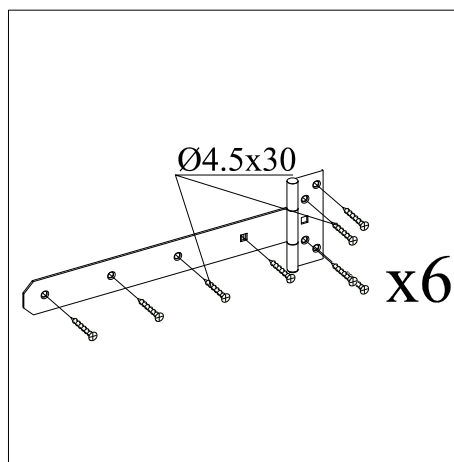
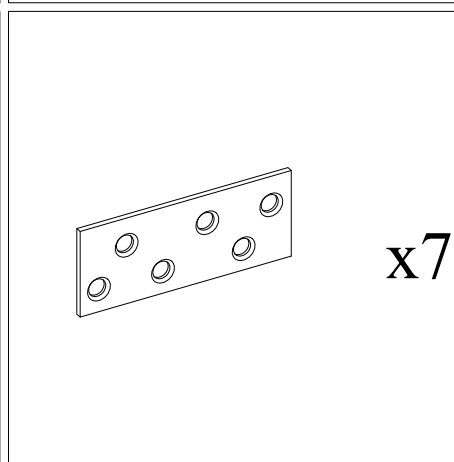
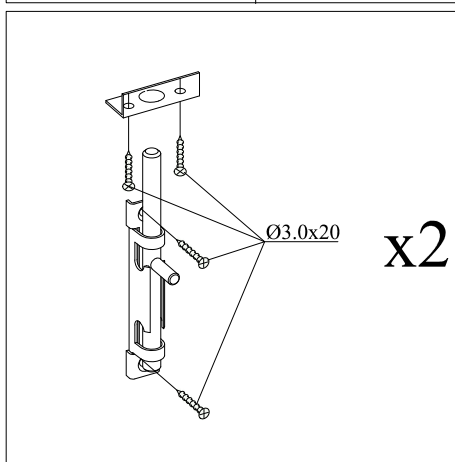
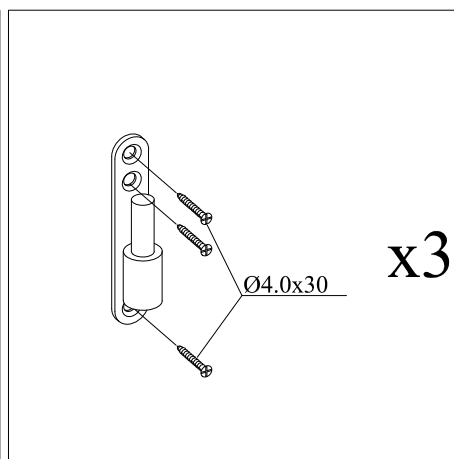
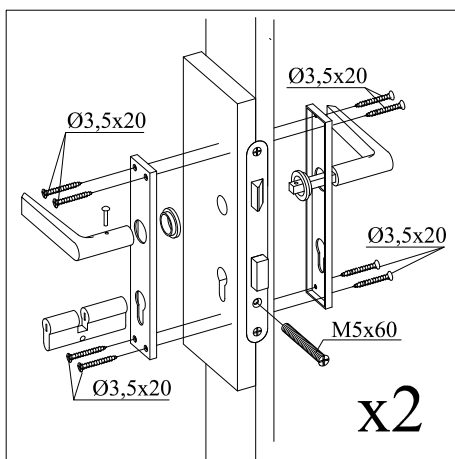

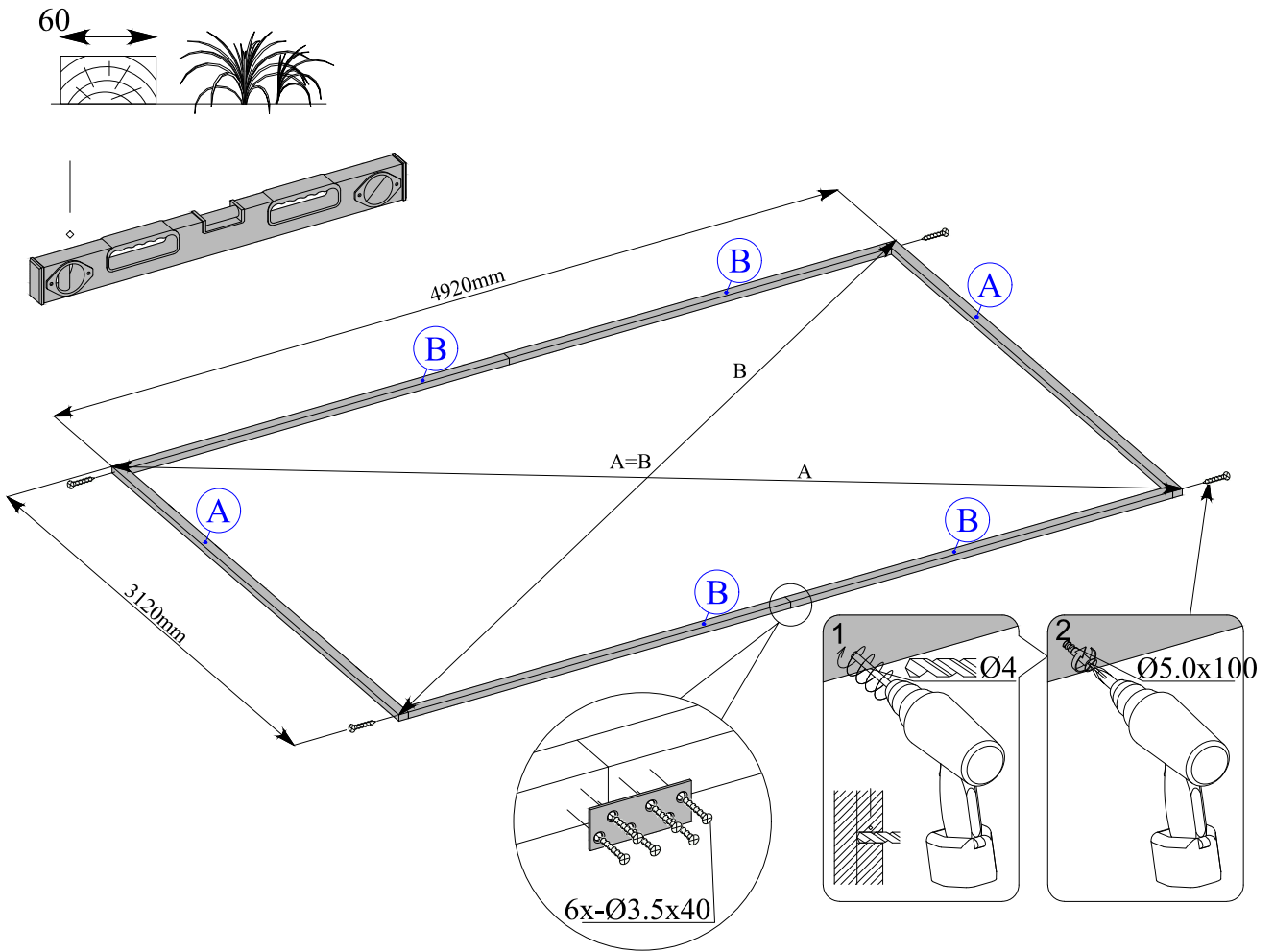

1

2

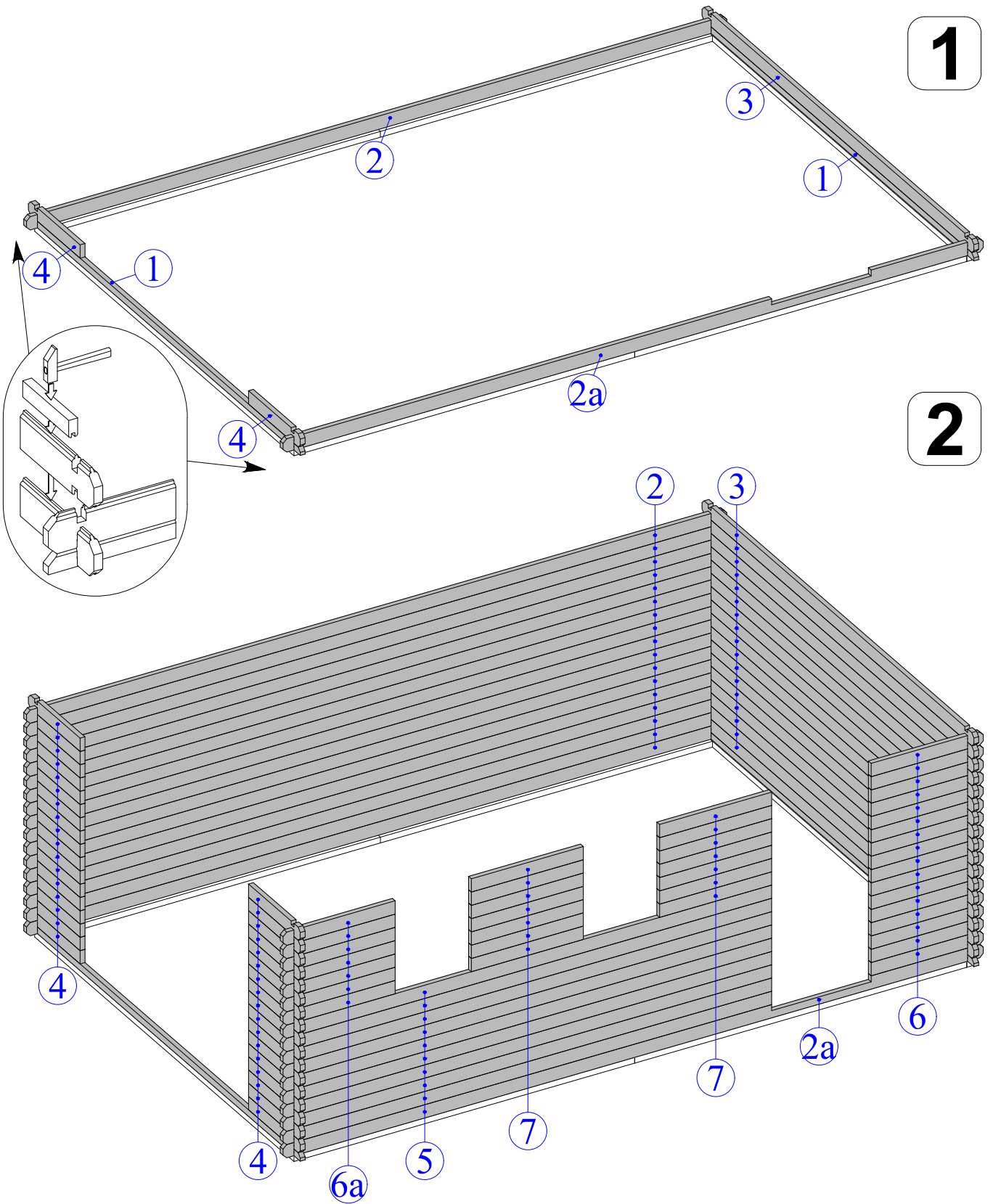

3

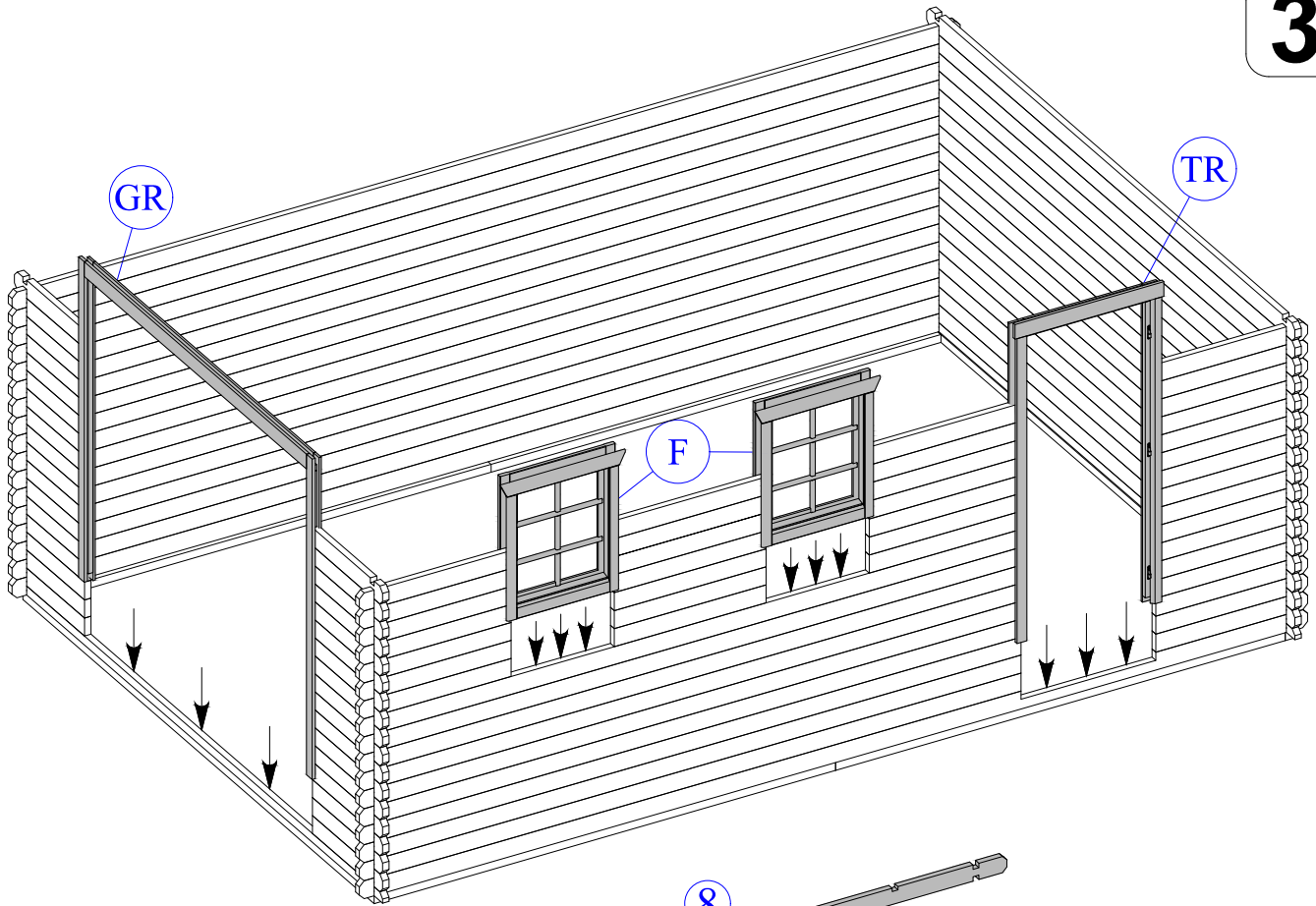

4

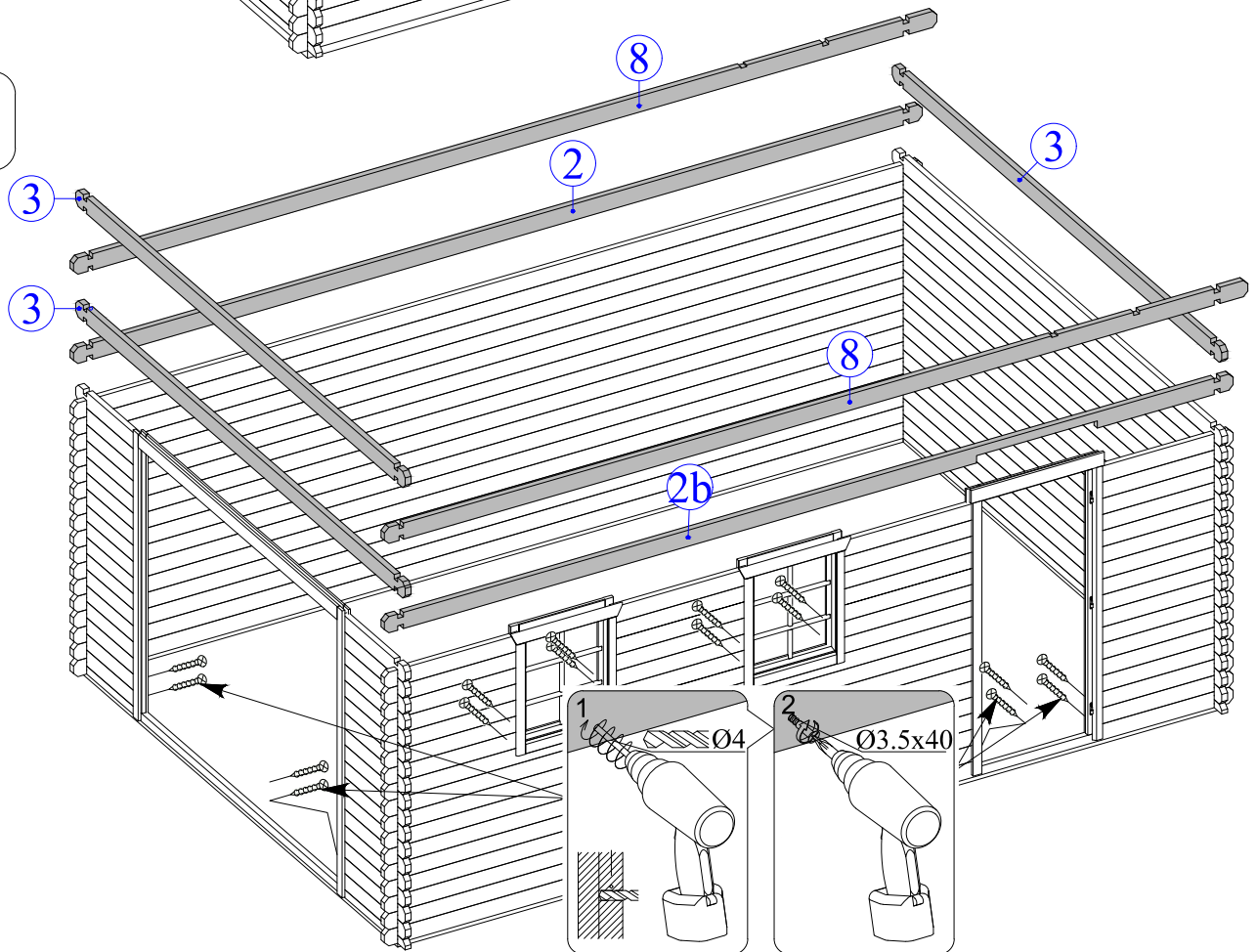

5

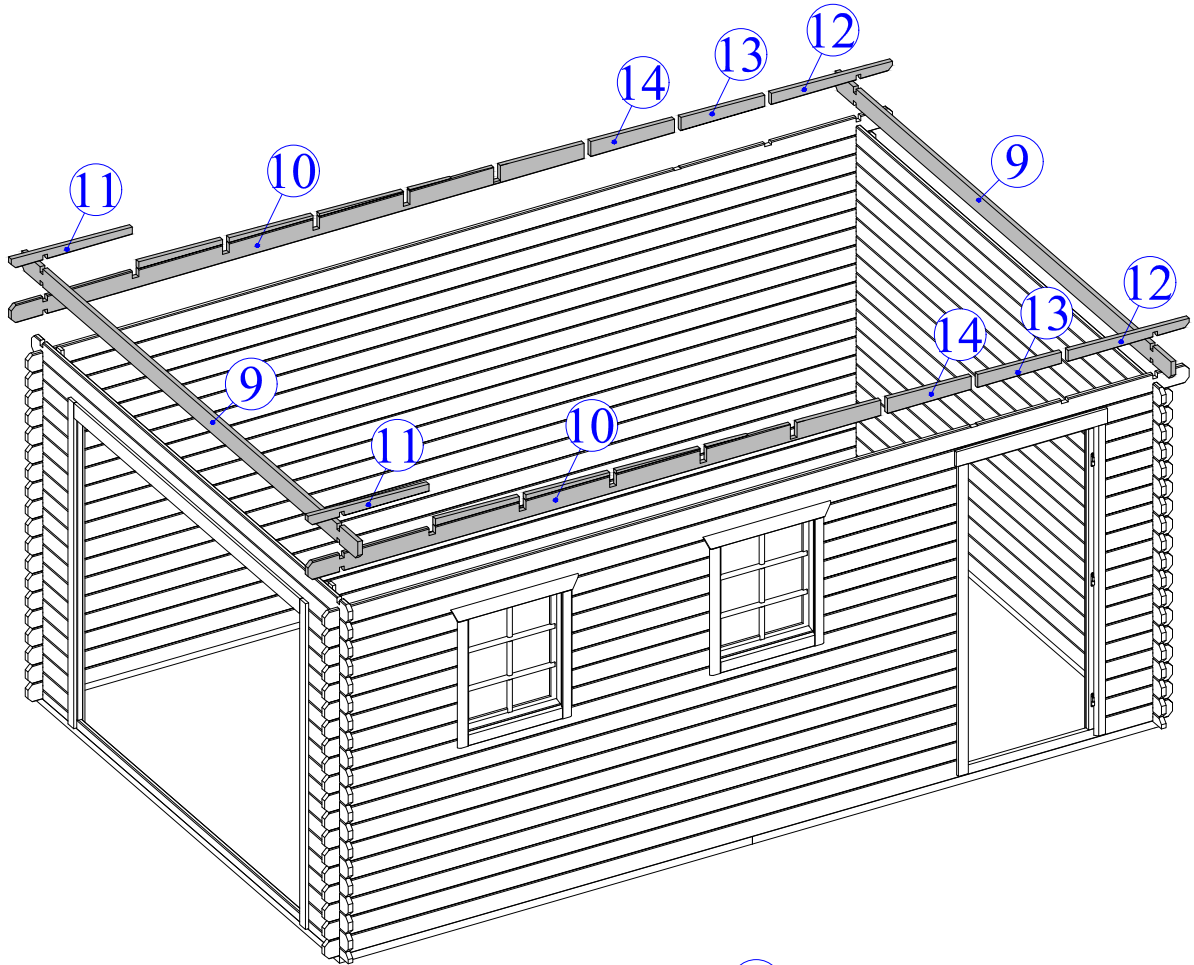

6

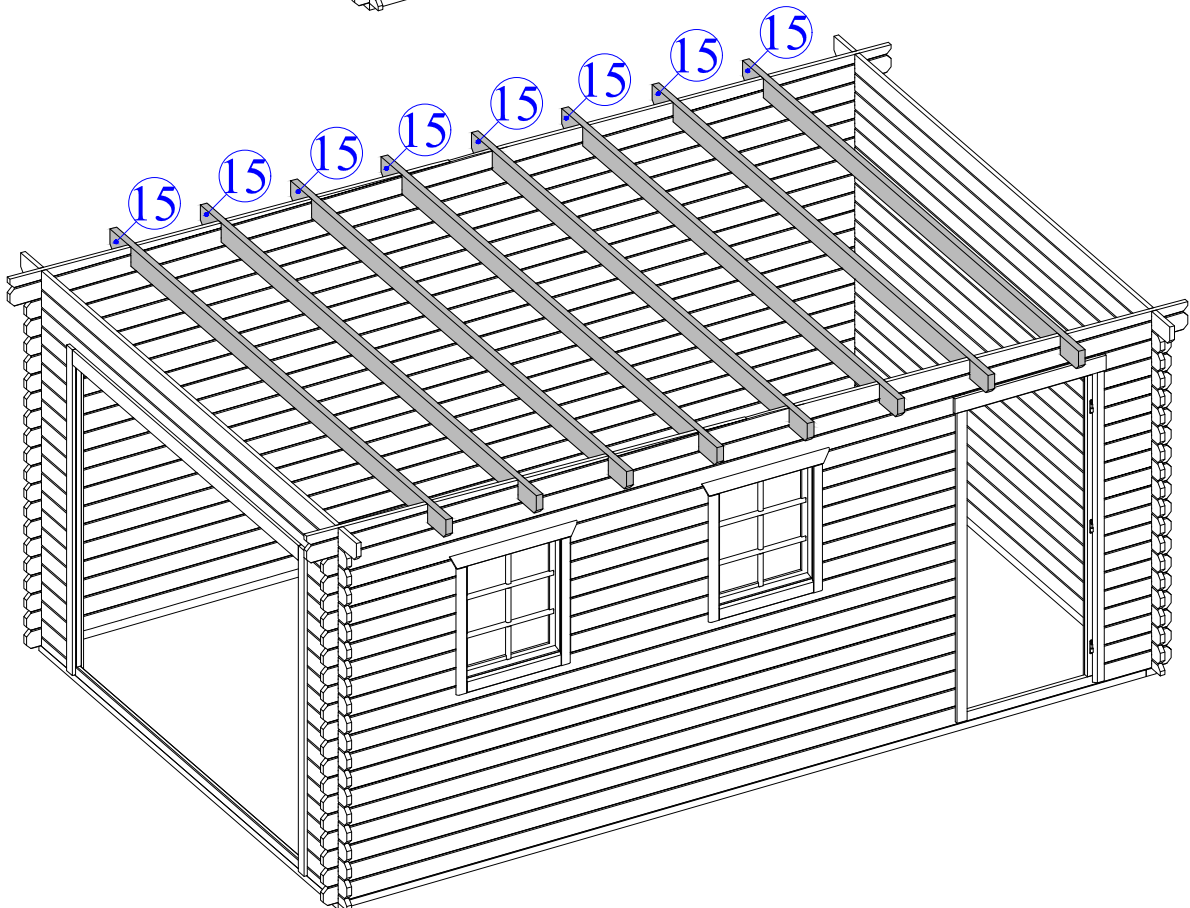

7

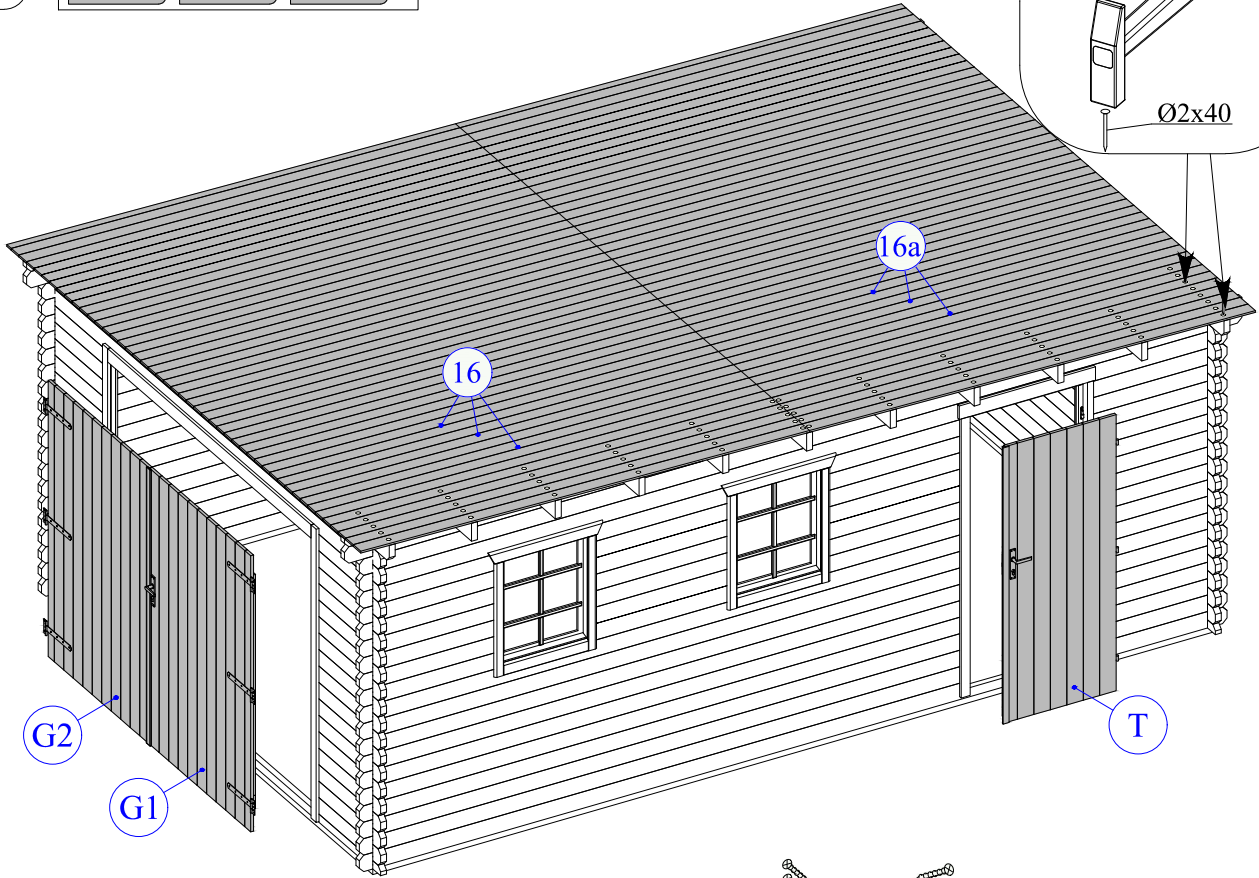
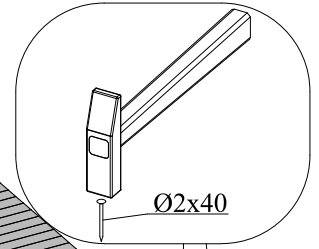
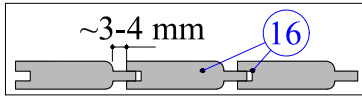

8

