

9359803

9359804

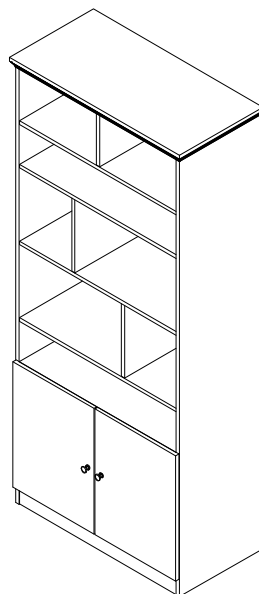

- |                                       |                                   |
|---------------------------------------|-----------------------------------|
| <b>D</b> Montageanleitung             | <b>GB</b> Assembly instructions   |
| <b>FR</b> Notice de montage           | <b>IT</b> Istruzioni di montaggio |
| <b>NL</b> Handleiding voor de montage | <b>PL</b> Instrukcja montażu      |
| <b>CZ</b> Montážní návod              | <b>SK</b> Návod na montáž         |
| <b>HU</b> Szerelési útmutató          | <b>RO</b> Instrucțiuni de montaj  |
| <b>TR</b> Montaj talimatı             | <b>RU</b> инструкция по монтажу   |

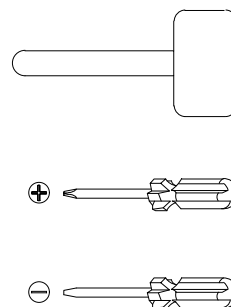
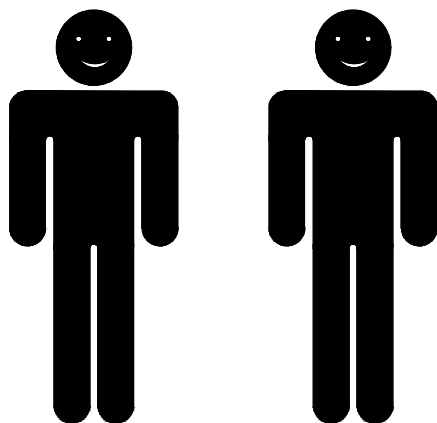









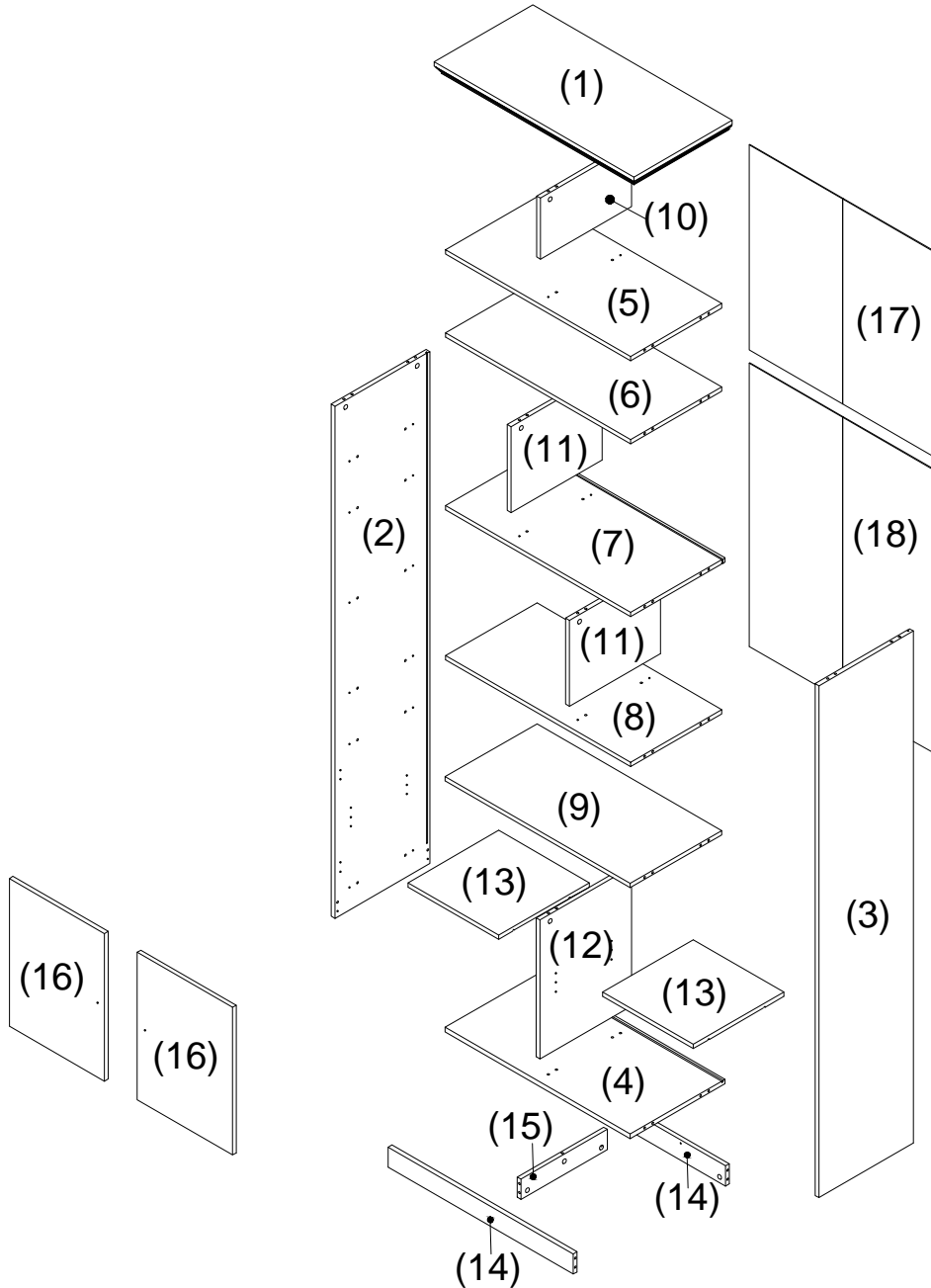
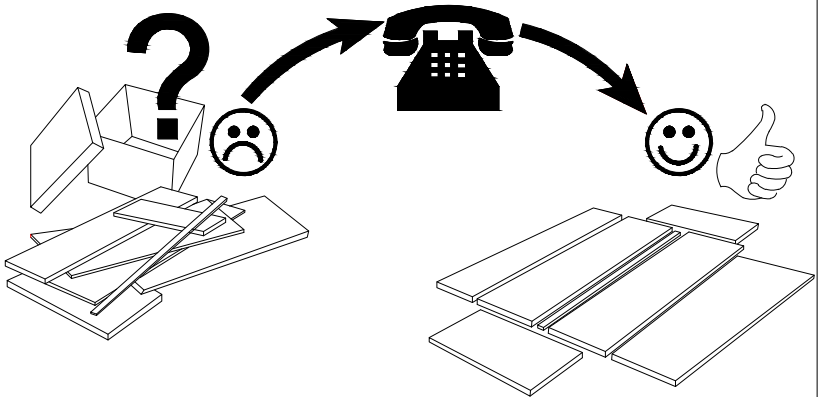
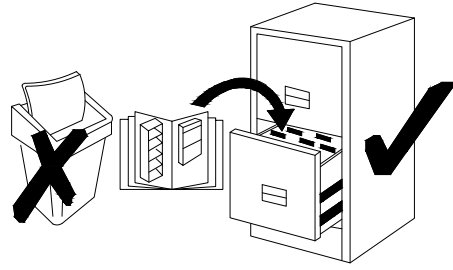

**Servise • Assistenza • Dienstverlening • Serwis  
Servis • Szerviz • Сервисная служба**

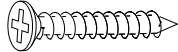
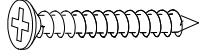



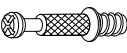

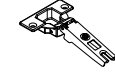



Name • Nom • Nome • Naam •  
Nazwa • Jméno • Názov • Név •  
Denumire • isim • Название •

Nr. • No. • N° • Номер • Č • Sz

Typ • Type • Тип • Tipus • Tipo •  
Тип



A		M3.5 X 16mm	46
B		M4 X 32mm	2
C		M4 X 38mm	6
D		M6 X 13mm	8
E		M6 X 40mm	2
F		Ø8 X 25mm	50
G			43
H			43
J1		5 / 8"	4
J2			4

K1			2
K2		MS4 X 20mm	2
L			8
M			20
N			8
P			6
Q			12
R			1
S			2
T			8

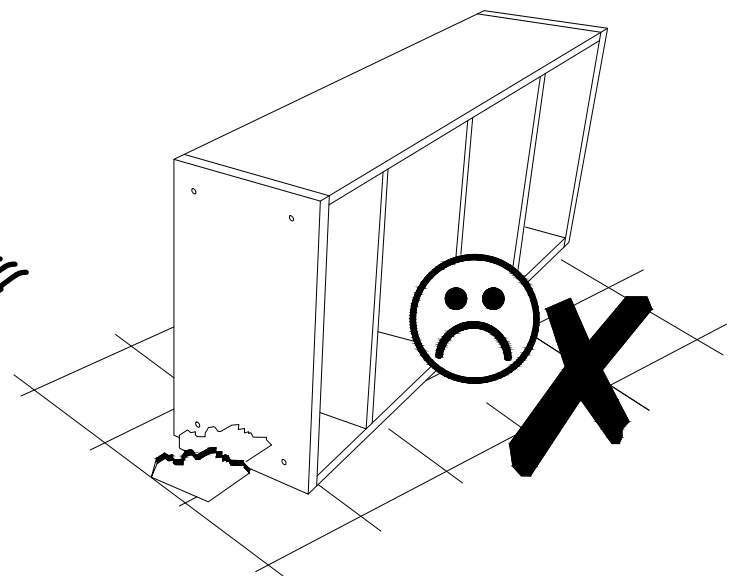
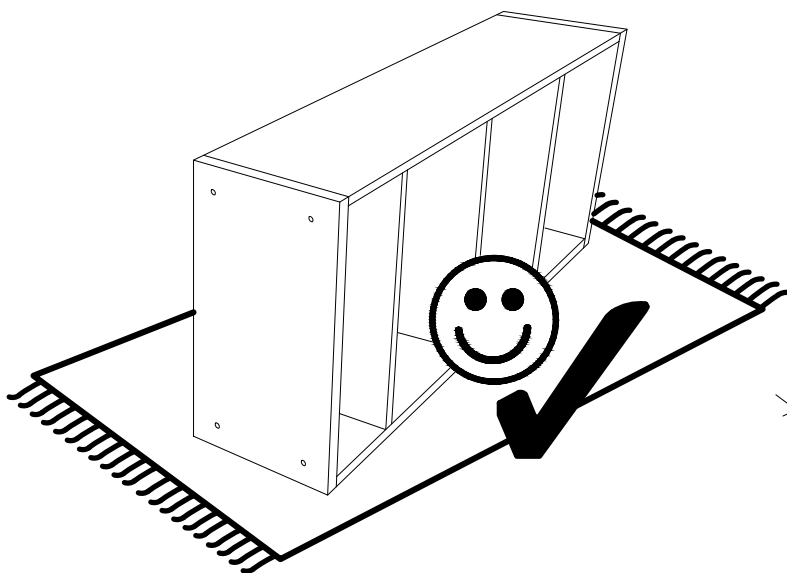

1

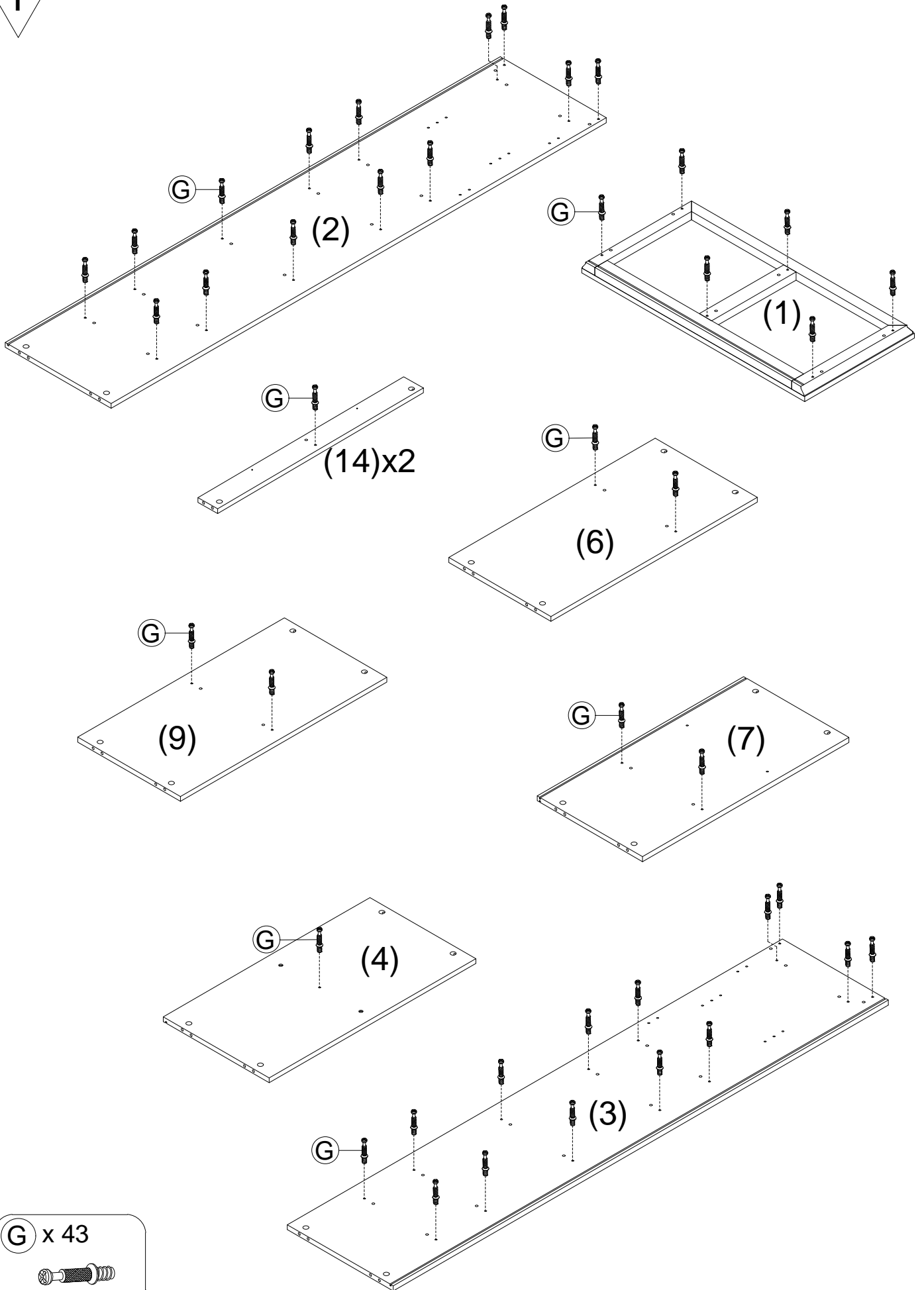

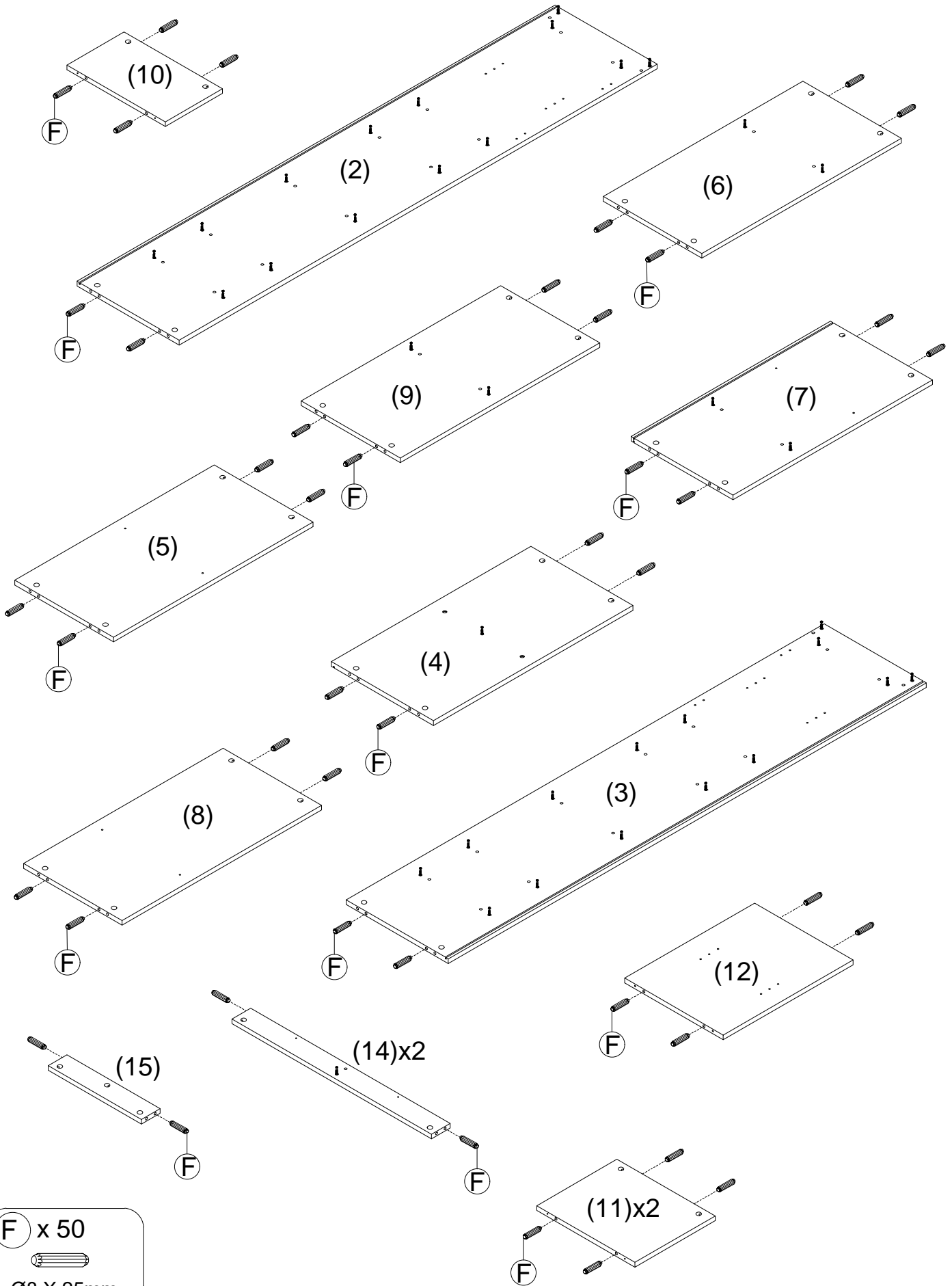

3

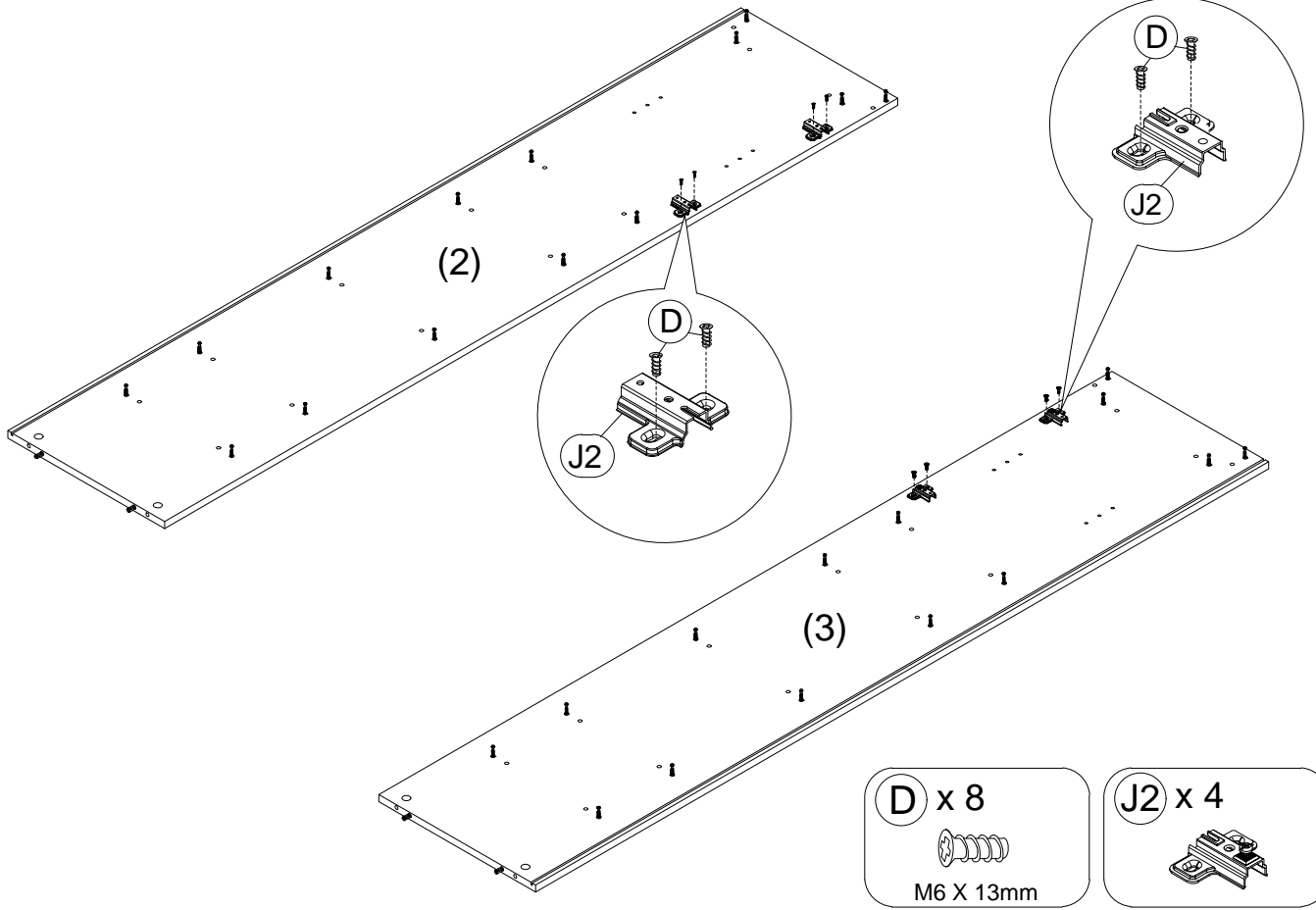

4

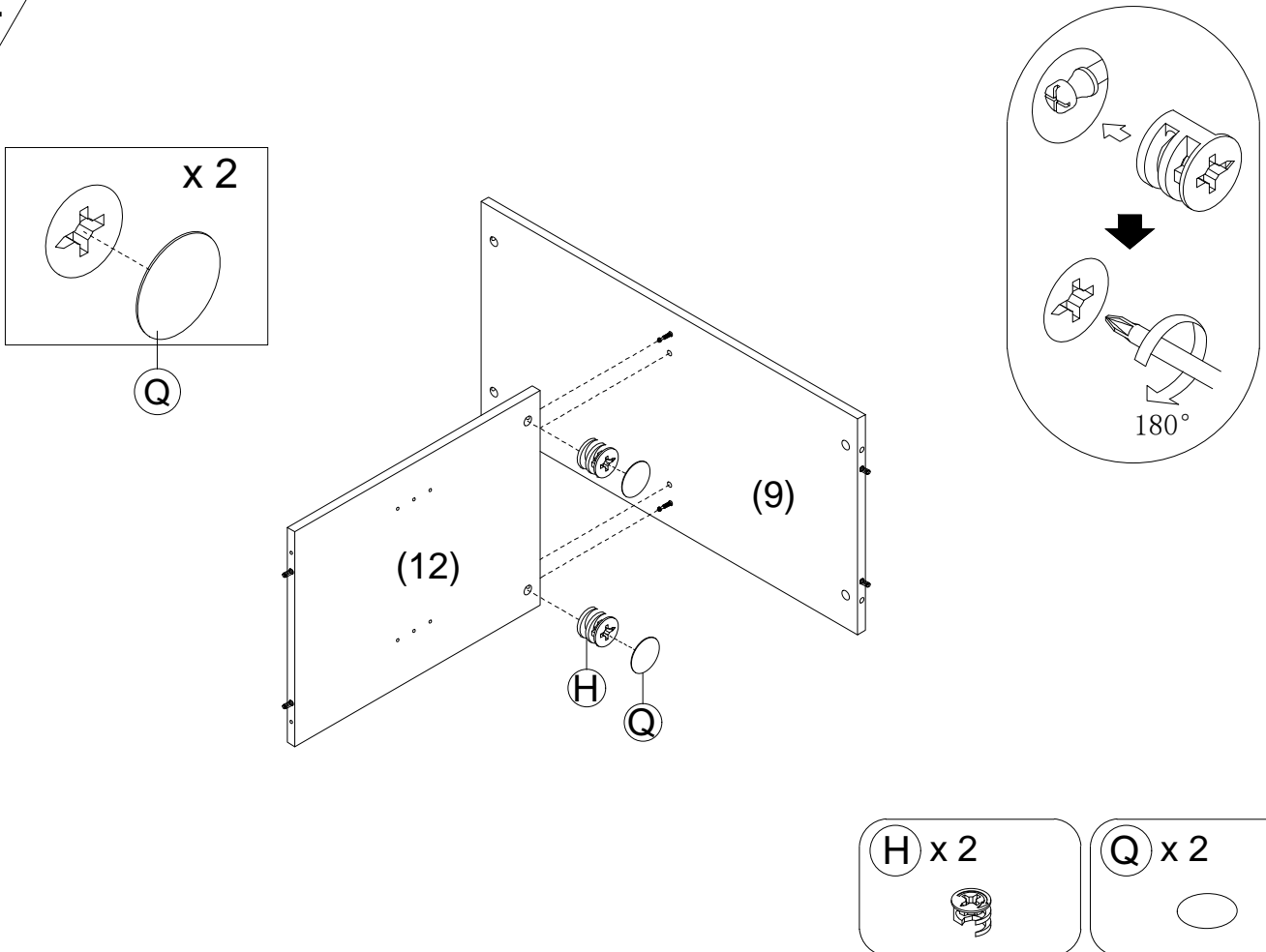

5

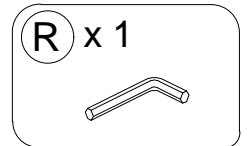
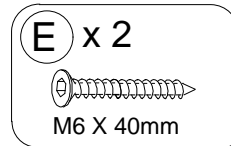
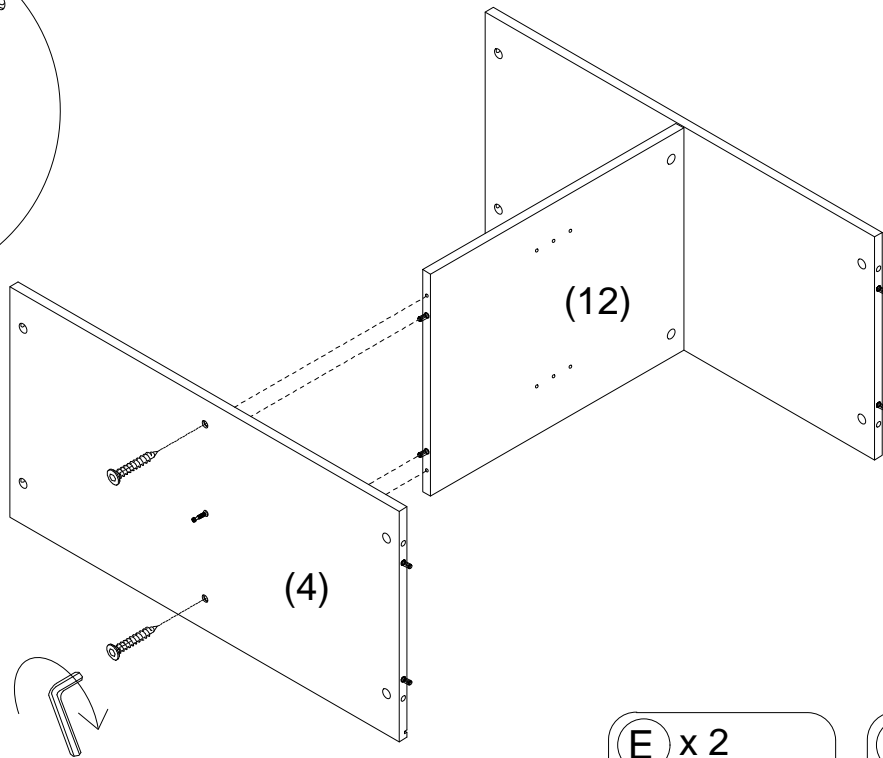
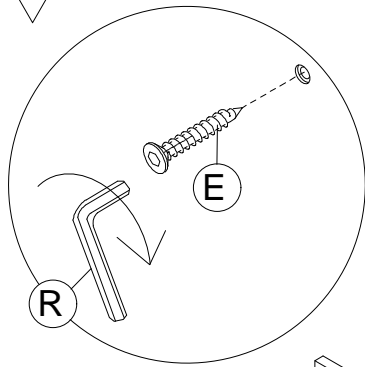

6

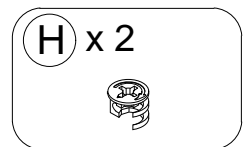
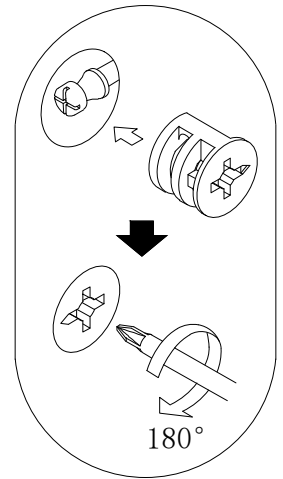
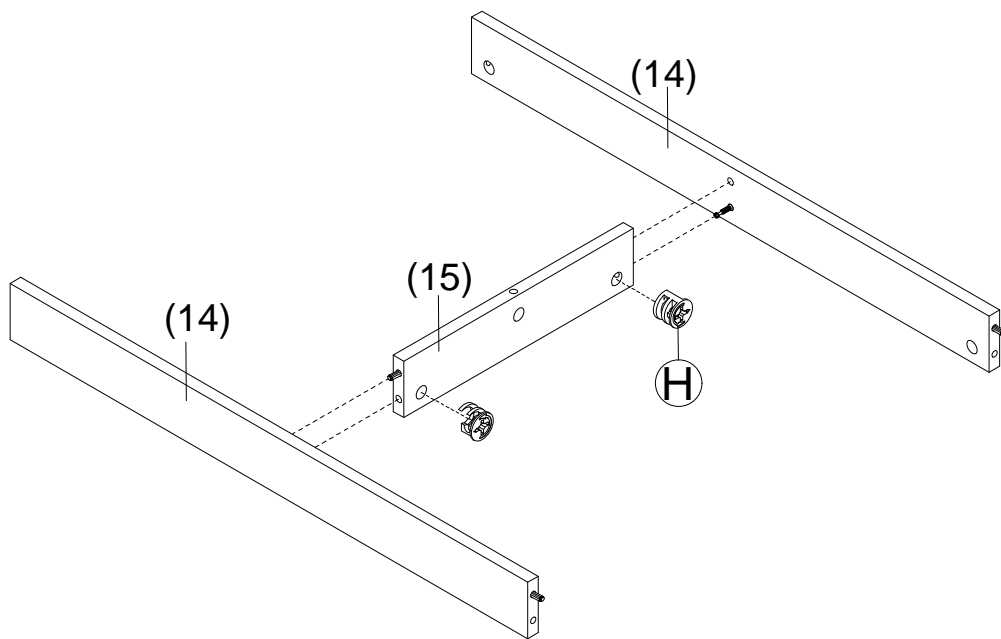

7

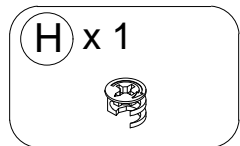
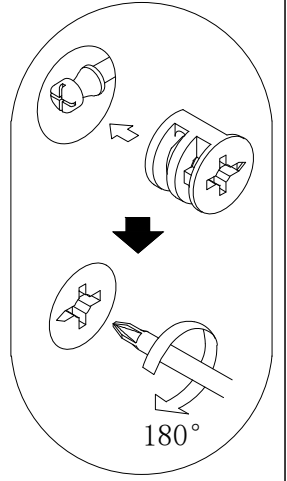
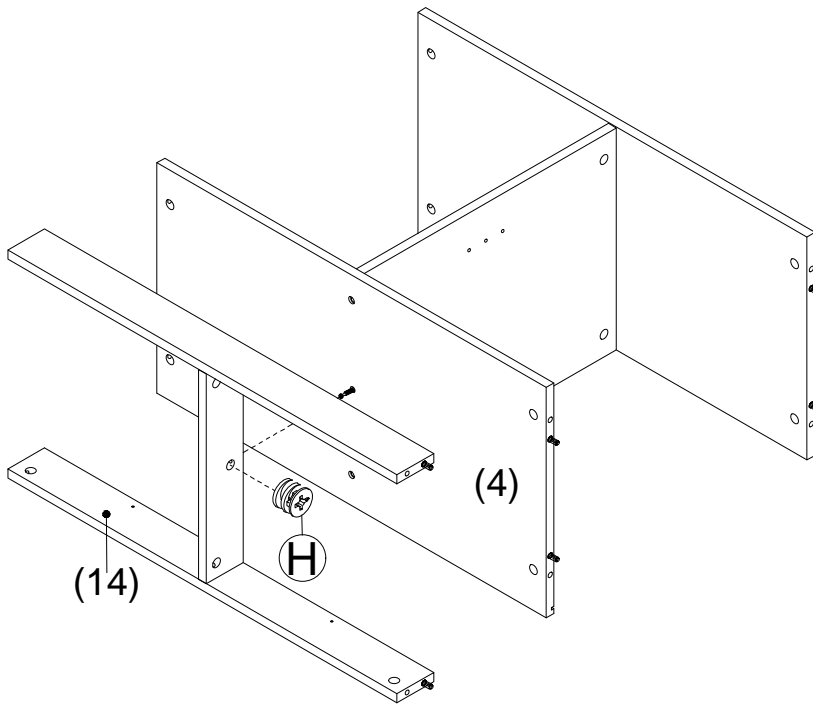

8

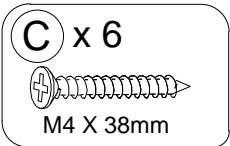
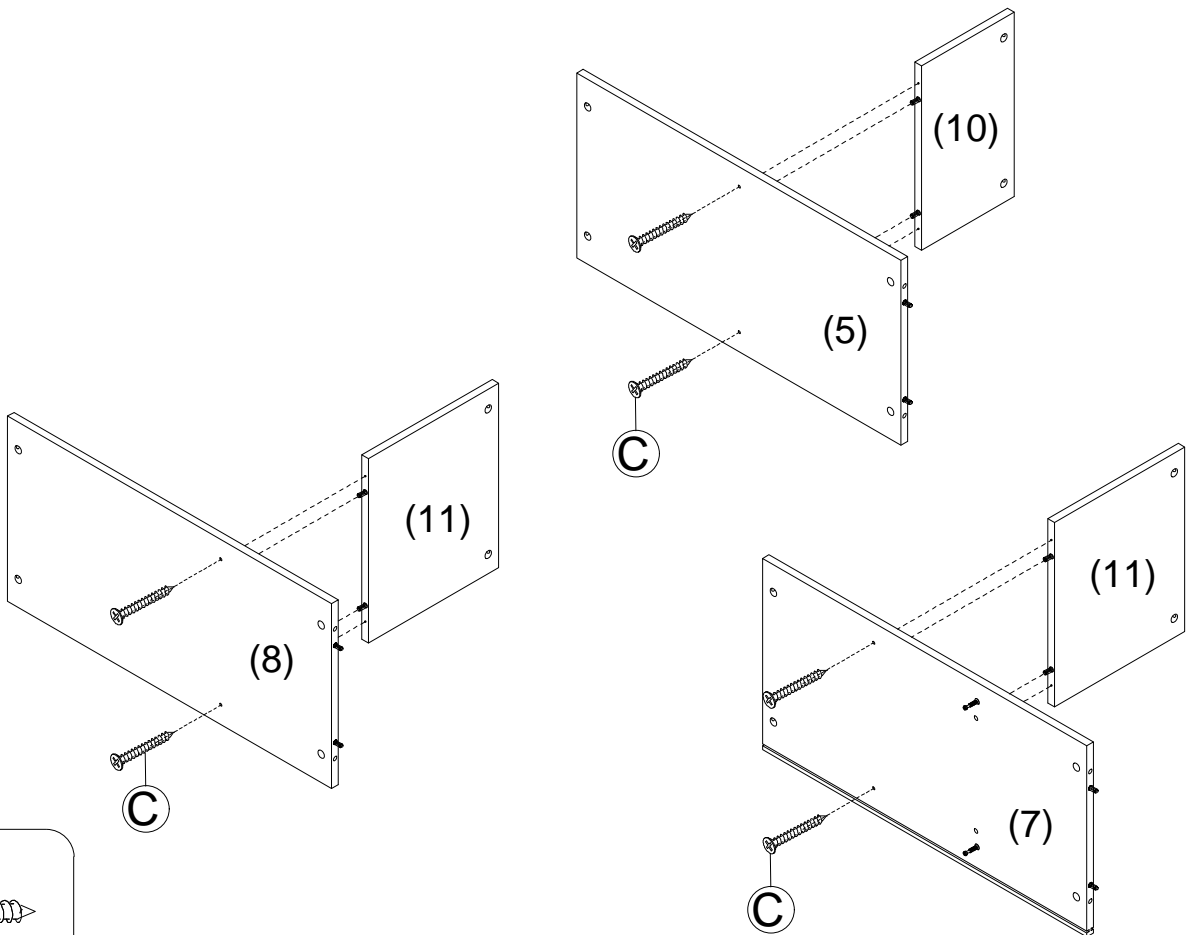



9

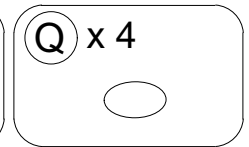
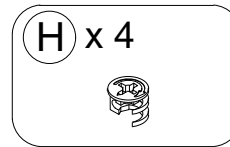
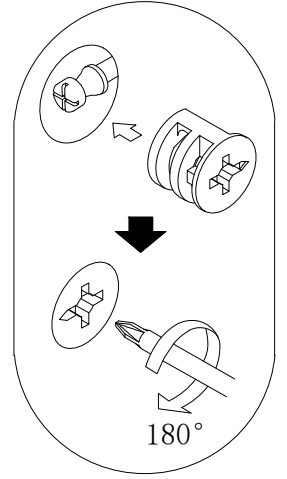
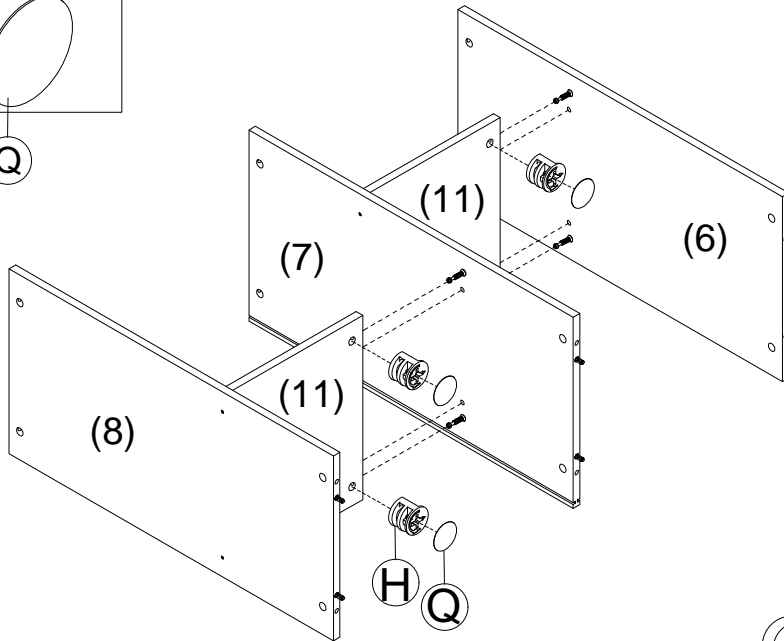
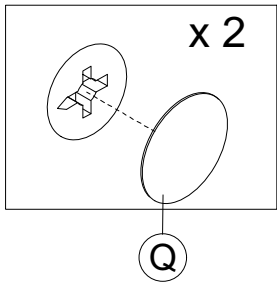

10

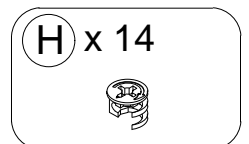
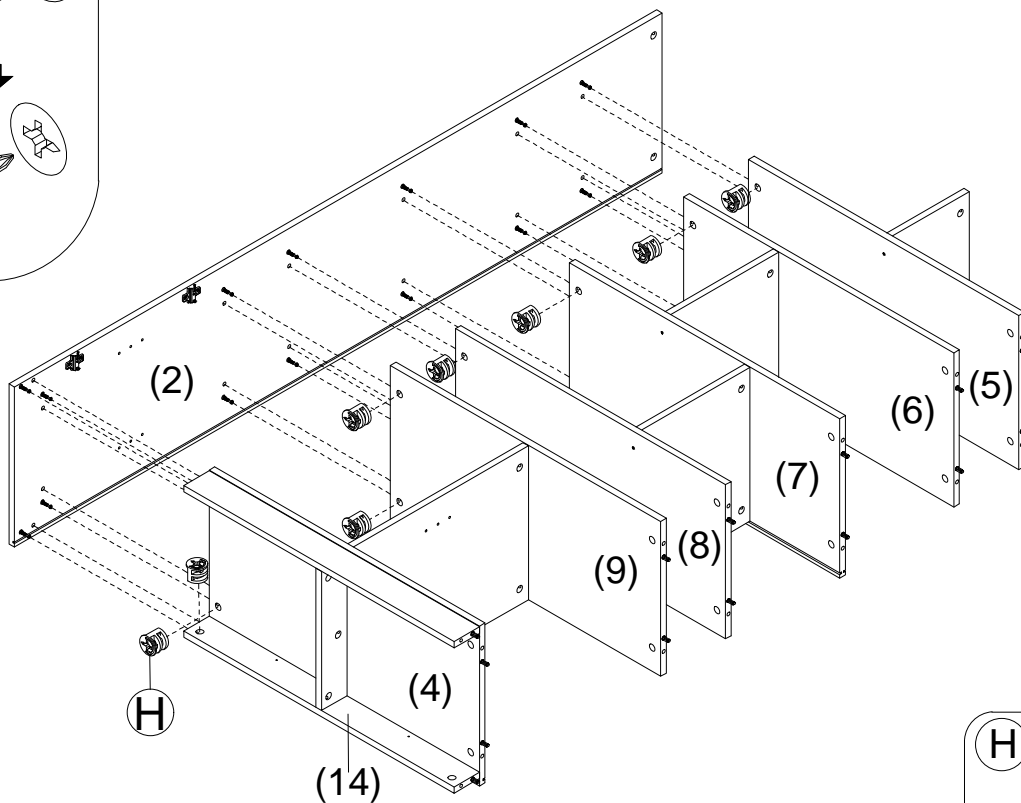
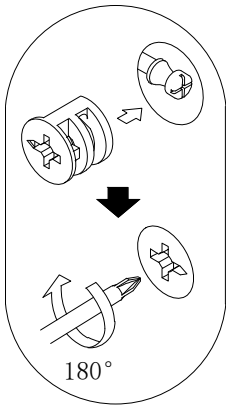

11

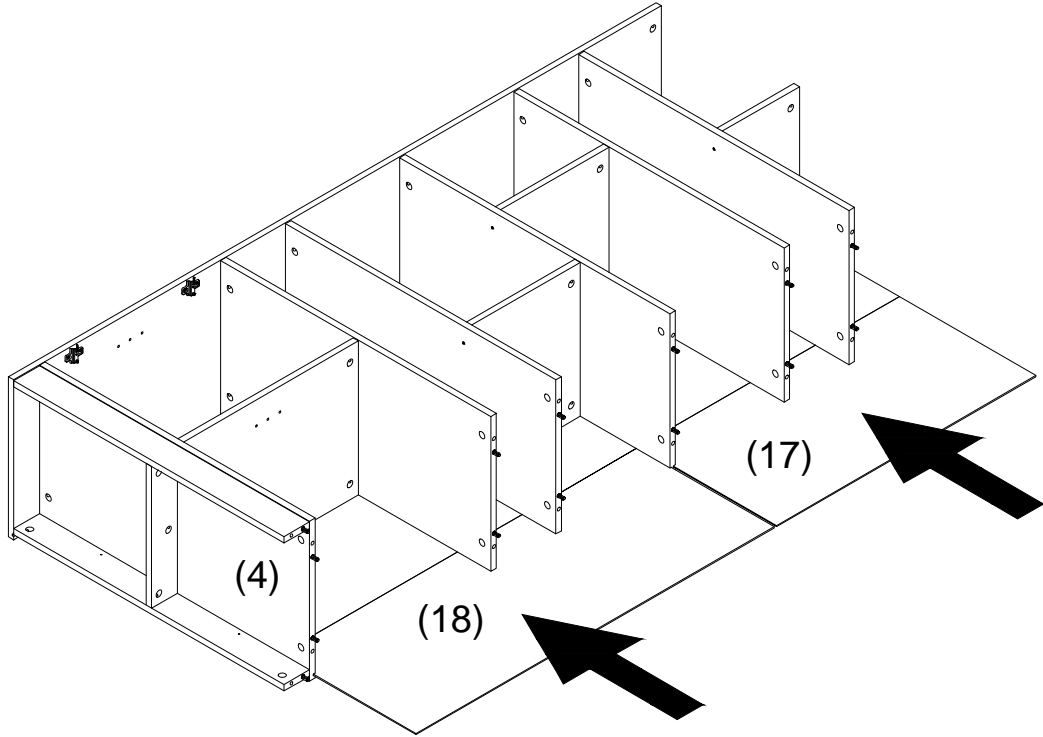

12

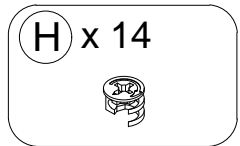
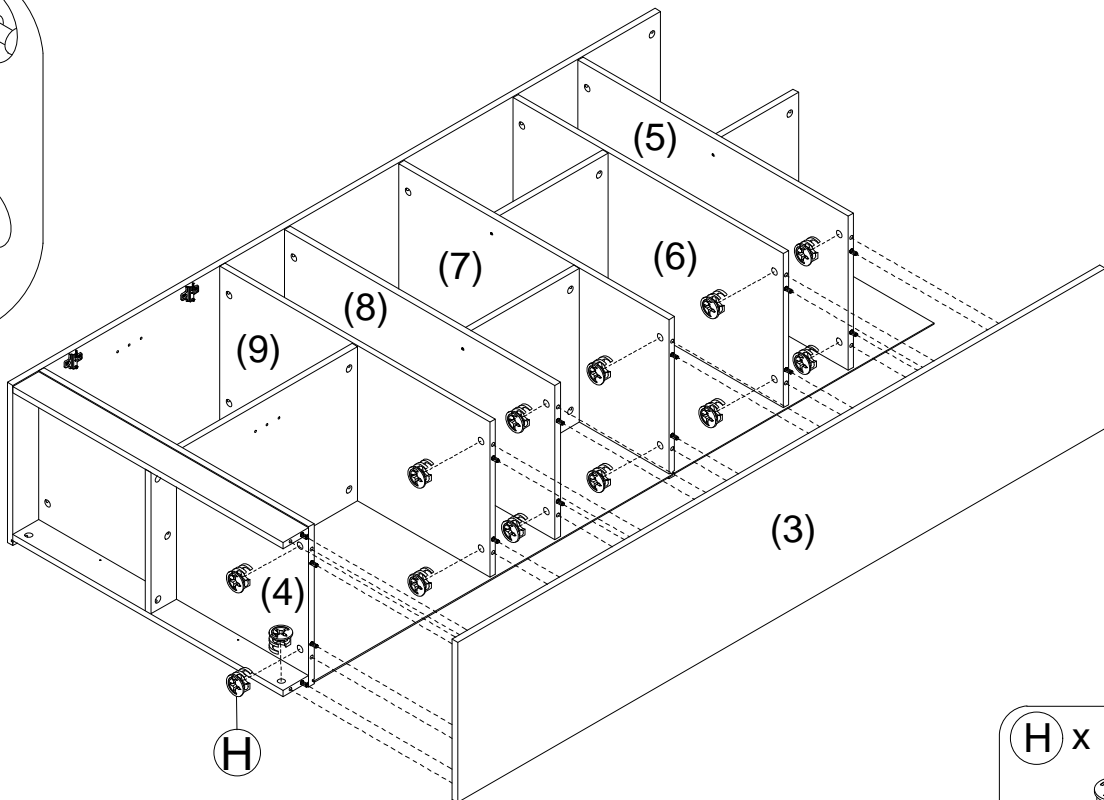
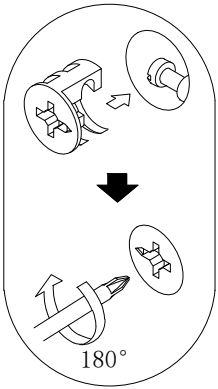

13

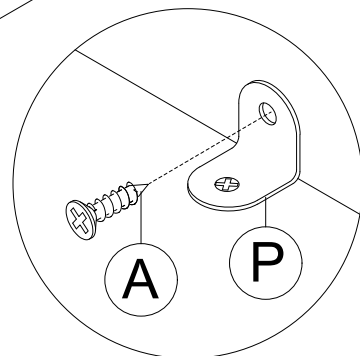
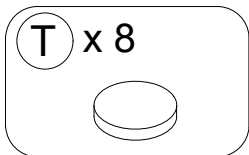
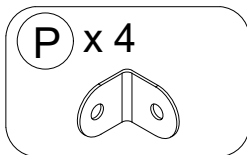
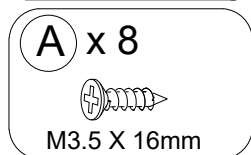
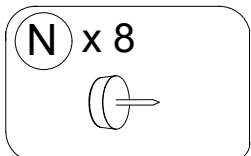
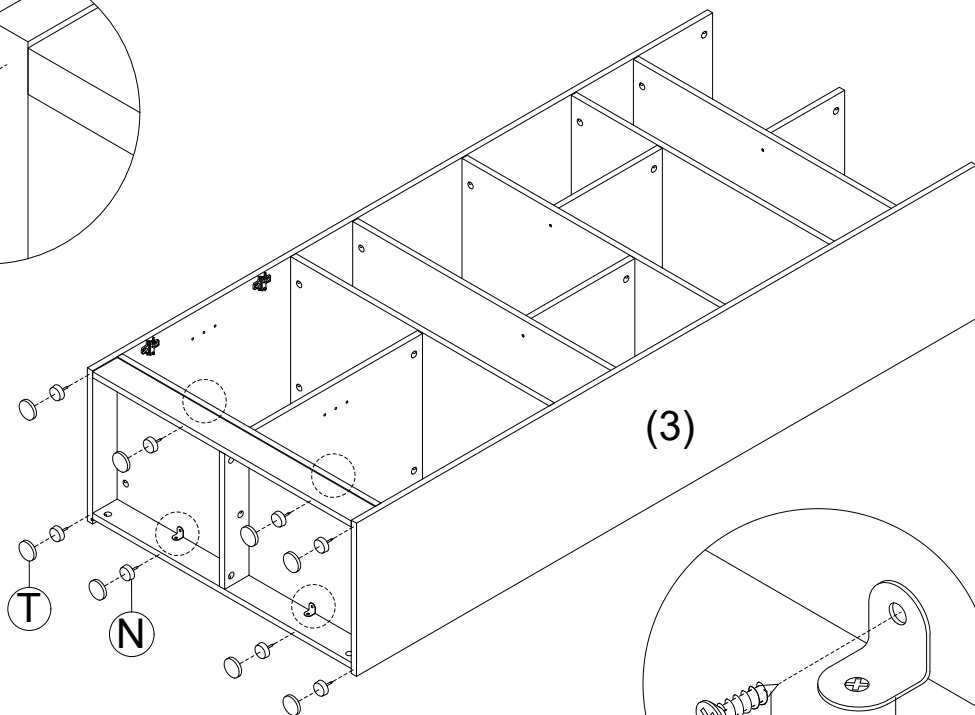
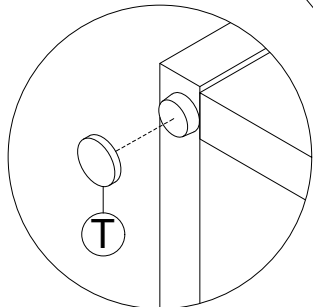
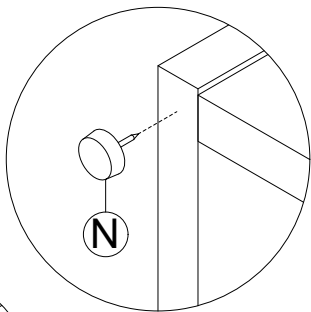

14

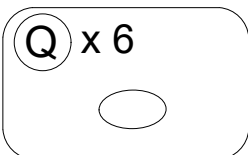
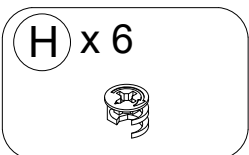
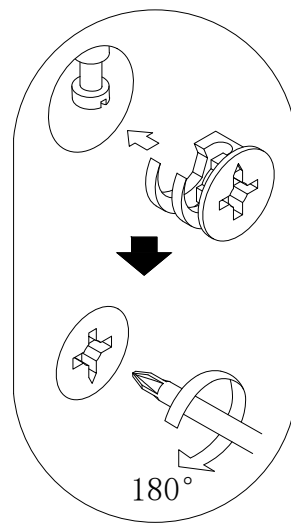
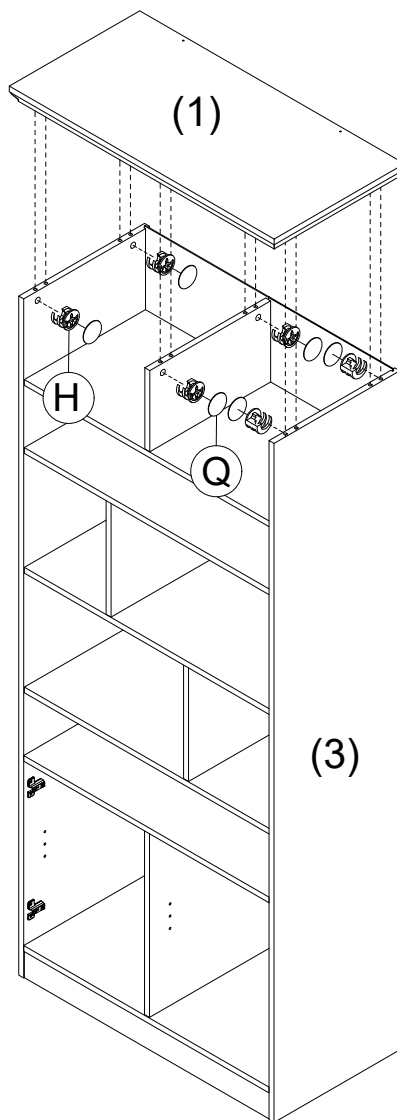

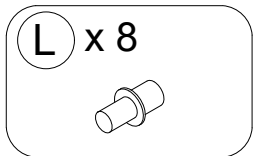
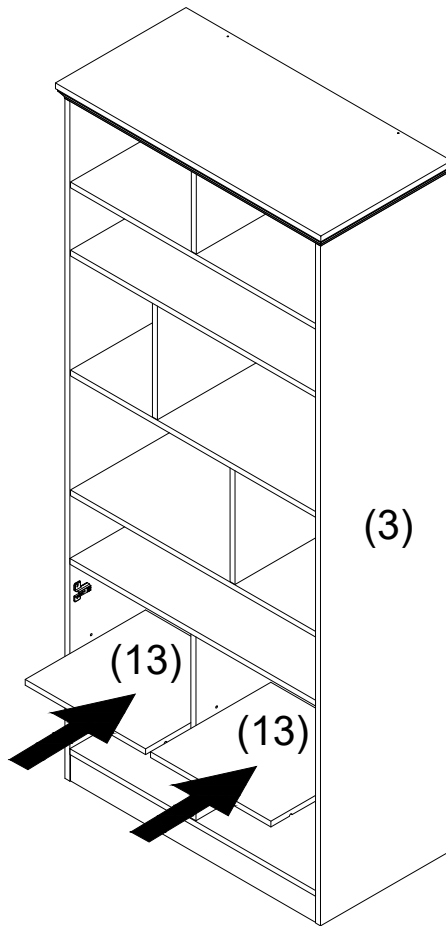
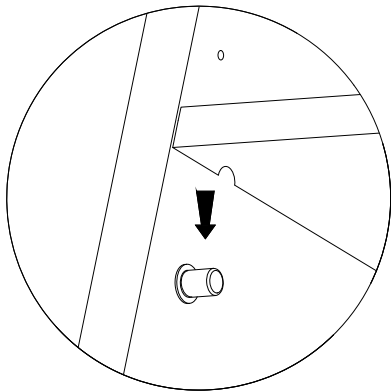
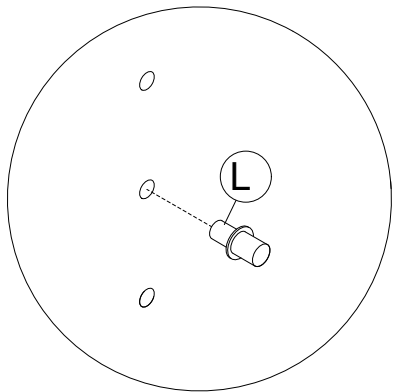

15

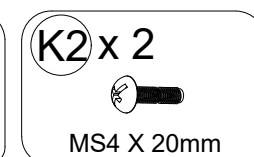
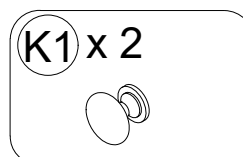
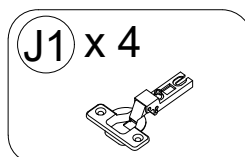
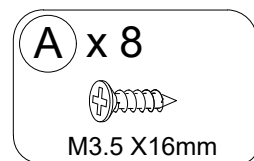
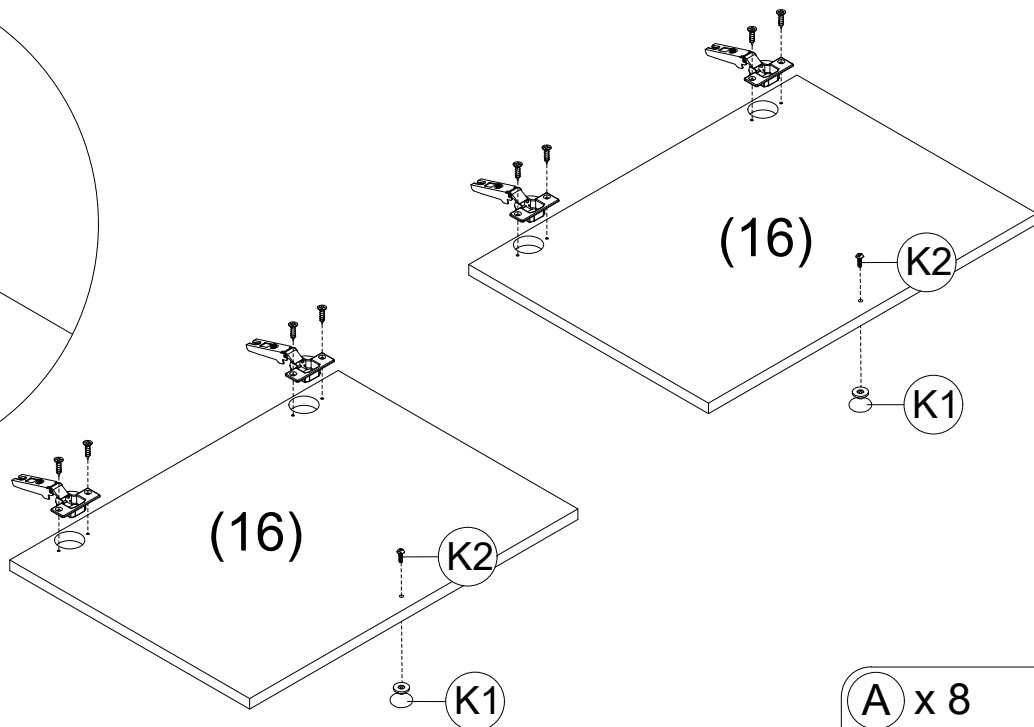
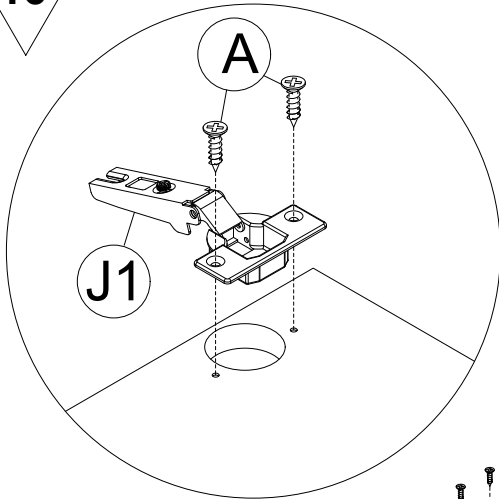

16



 <b>Achtung • Attention • Attenzione • Opgelet • Uwaga • Pozor • Figyelem • Atenție • Dikkat • Вниманіе</b> 	
<b>D</b>	Türen einstellen (Scharniere justieren)
<b>GB</b>	Adjusting the doors (adjusting the hinges)
<b>NL</b>	Deuren instellen (scharnieren afstellen)
<b>PL</b>	Nastawić drzwi (wyrównać zawiasy)
<b>TR</b>	Kapılann ayarlanması (menteselerin seviye ayarı)
<b>RU</b>	Регулировка дверей (регулировка шарниров)
<b>FR</b>	Régler les portes (ajuster les charnières)
<b>IT</b>	Sistemare le porte (regolare le cerniere)
<b>CZ</b>	Vyrovnejte dvířka (seřďte závěsy)
<b>SK</b>	Nastavenie dverí (nastavenie závesov)
<b>HU</b>	Állítsa be az ajtókat (állítsa be a zsanérokat)
<b>RO</b>	Reglare ușii (ajustare balamale)

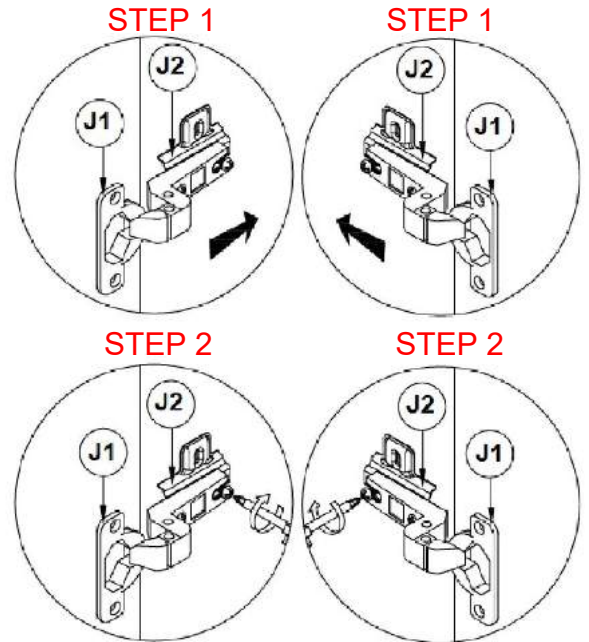
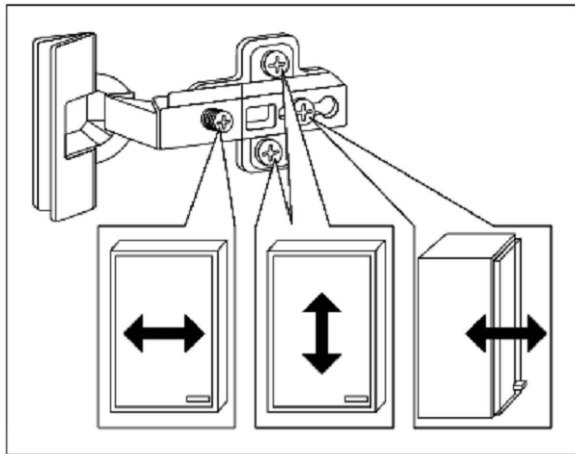

17

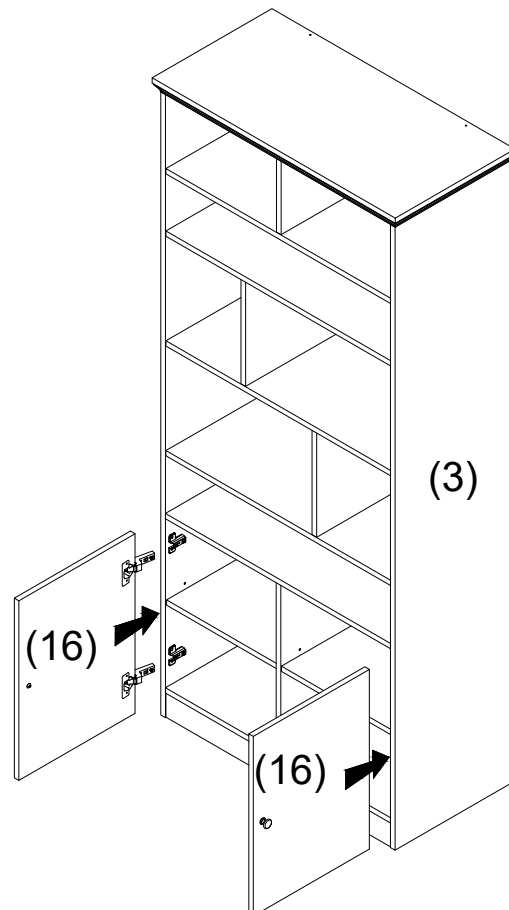

18

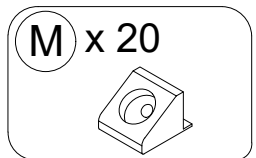
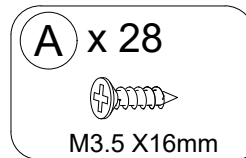
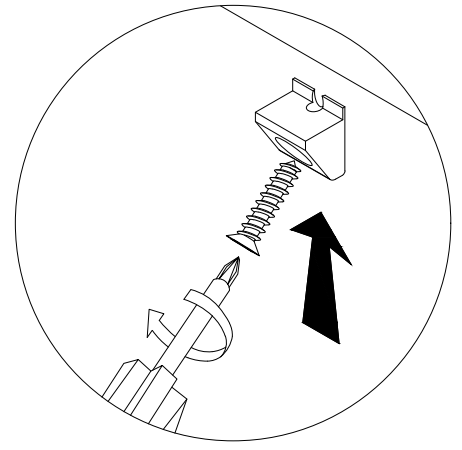
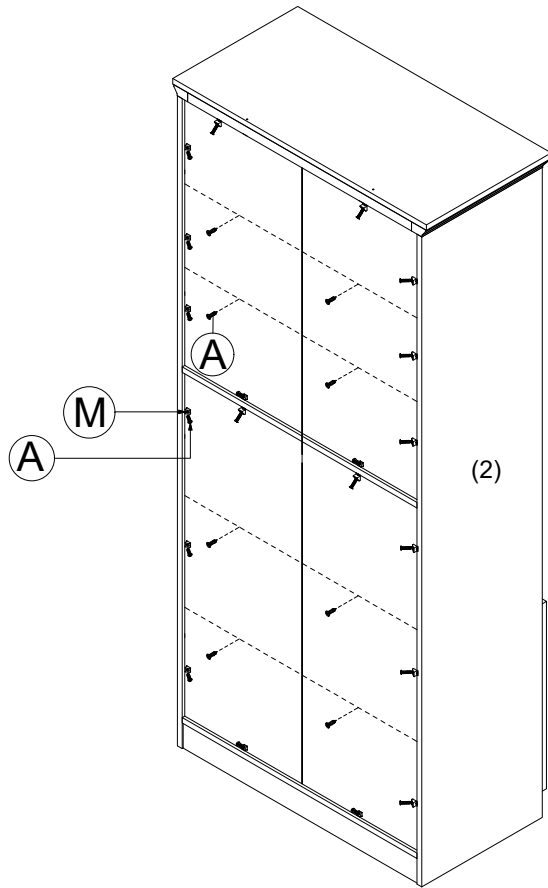

19

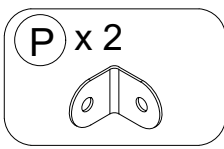
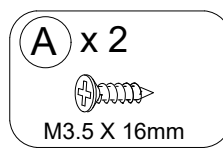
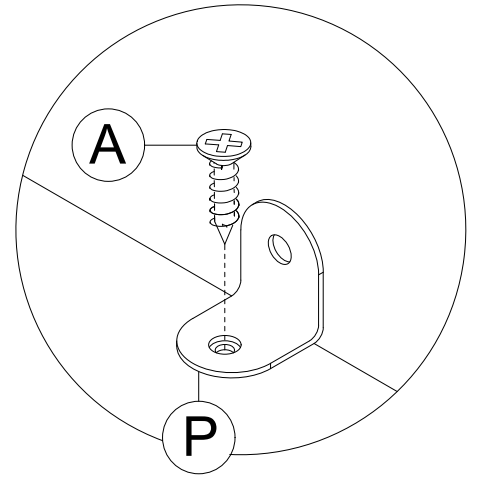
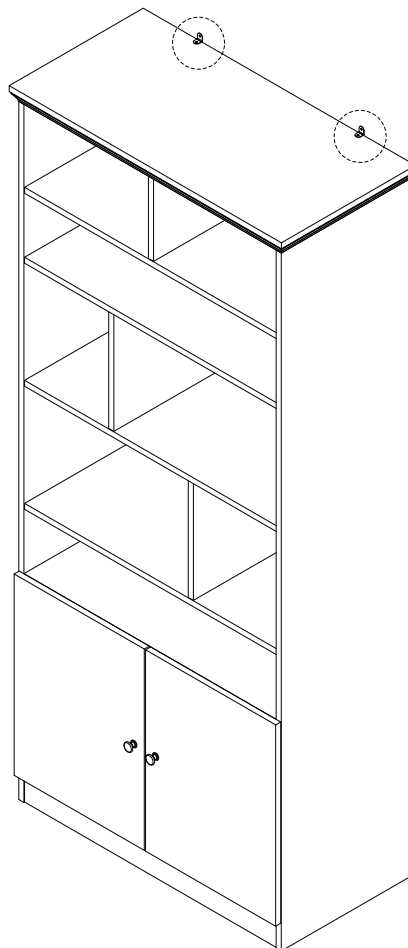

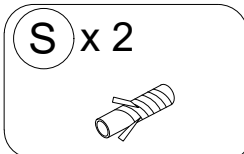
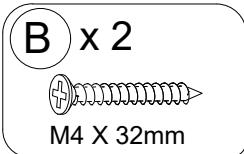
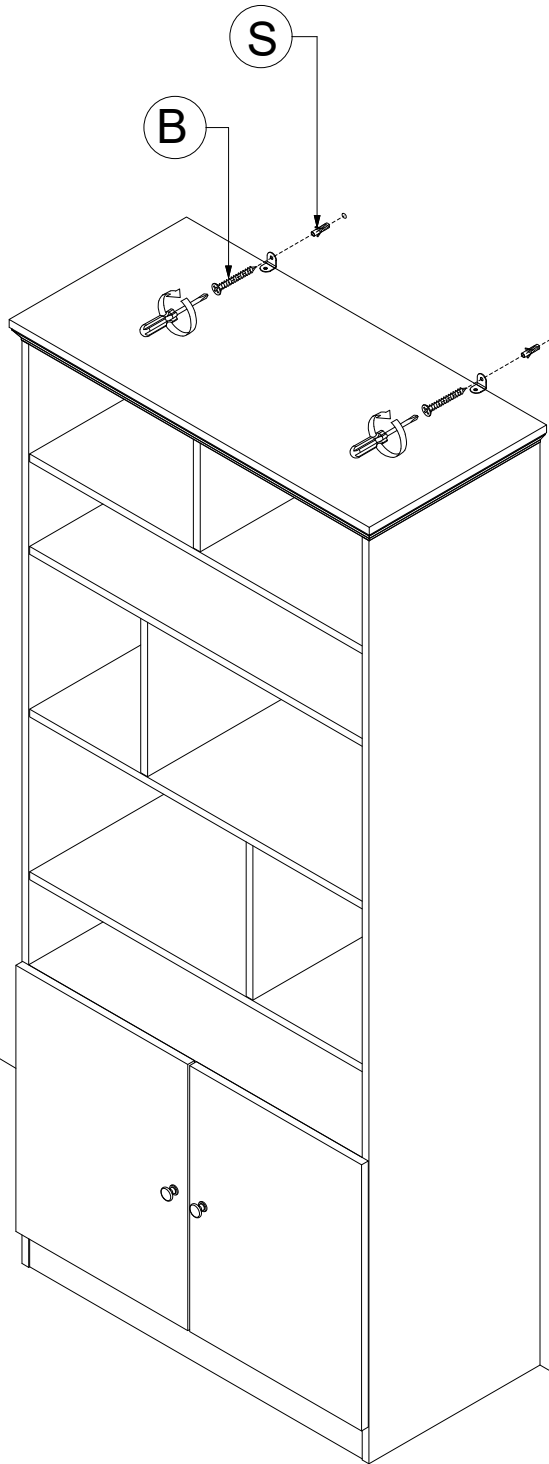
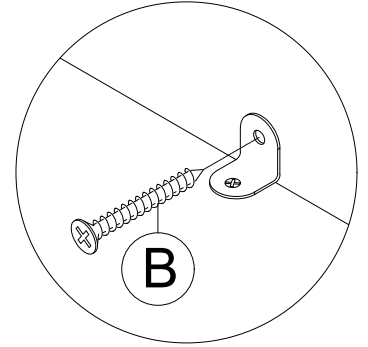
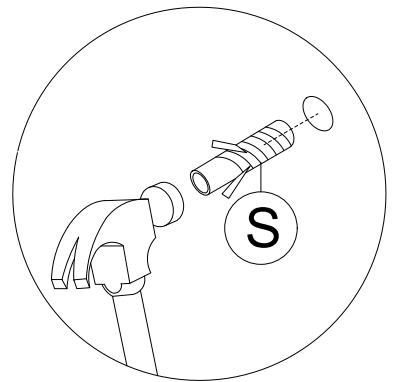
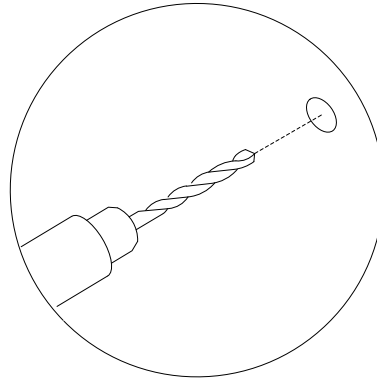

<b>D</b>	Das beigefügte Wandbefestigungsmaterial (Dübel und Schrauben) eignet sich nur für festes Mauerwerk (z.B. Beton- oder Ziegelwände). Für andere Wandaufbauten sind eventuell Spezialdübel und andere Schrauben notwendig. Ziehen Sie gegebenenfalls eine Fachkraft zurate.
<b>GB</b>	The enclosed wall mounting materials (dowels and screws) are only suitable for solid masonry (e. g. concrete or brick walls). Special dowels and other screws may be necessary for other wall constructions. If necessary, please consult a qualified professional.
<b>FR</b>	Le matériel de fixation murale fourni (chevilles et vis) convient uniquement à des murs solides (p. ex. murs en béton ou en briques). Pour les autres constructions de murs, il faut éventuellement des chevilles spéciales et d'autres vis. Faites-vous conseiller par un spécialiste.
<b>IT</b>	I materiali di fissaggio allegati (tasselli e viti) sono adatti solo ai muri compatti (ad es. di calcestruzzo o mattoni). Per altri tipi di pareti è probabile che occorrono tasselli speciali e altre tipologie di viti. Richiedere eventualmente il consiglio di un esperto.
<b>NL</b>	Het bijgeleverde bevestigingsmateriaal (pluggen en schroeven) is geschikt voor vaste muren (bijv. betonnen of bakstenen muren). Voor andere muurconstructies zijn eventueel speciale pluggen en andere schroeven noodzakelijk. Consulteer eventueel een vakman.
<b>PL</b>	Załączony zestaw montażowy do zamocowania artykułu do ściany (kołki, wkręty, haki itp.), przeznaczony jest wyłącznie do montażu artykułu na ścianach wykonanych z cegły lub betonu. Przy montażu artykułu na ścianie wykonanej z innych materiałów, należy zastosować odpowiednie do niej zamocowania. W razie wątpliwości prosimy zasięgnąć porady fachowca.
<b>CZ</b>	Příložený materiál pro montáž na stěnu (hmoždinky a šrouby) je vhodný jen pro pevné zdivo (např. betonové nebo cihlové stěny). Pro jiné skladby stěn budou případně nutné speciální hmoždinky a jiné šrouby. Porad'te se případně s odborníkem.
<b>SK</b>	Priložený materiál pre upevnenie na stenu (hmoždinky a skrutky) je vhodný len pre pevné murivo (napr. betónové alebo tehlové steny). Pre iné steny sú potrebné príp. špeciálne hmoždinky a iné skrutky. V prípade potreby sa porad'te s odborníkom.
<b>HU</b>	A mellékelt fali rögzítőkészlet (tipli és csavarok) csak tömött falazatban (pl. betonfalban, téglafalban) használható. Más faltípusokhoz speciális tiplire és csavarra lesz szükség. Szükség esetén kérje ki egy szakember véleményét.
<b>RO</b>	Materialul furnizat pentru montajul de perete (dibluri și șuruburi) este adecvat numai pentru zidărie solidă (de exemplu pereți din beton sau din cărămidă). Pentru alte structuri de pereți, este posibil să fie necesare dibluri speciale, precum și alte șuruburi. Dacă este necesar, consultați un specialist.
<b>TR</b>	Teslimat kapsam ndaki duvar tipi sabitleme materyali (dübel ve vidalar) sadece beton ve tuğla duvarlar gibi sağlam duvar yap lar için uygundur. Başka duvar yap lar için özel dübell er veya başka vidalar gerekli olabilir. Gerekirse bir uzmandan yard m al n z.
<b>RU</b>	Входящий в комплект поставки материал для крепления на стене (дюбели и болты) предназначен только для прочных каменных стен (например, бетонных или кирпичных). Для других типов стен используйте по мере необходимости специальные дюбели и другие болты. По мере необходимости обратитесь за помощью к специалистам.

<b>D</b>	Bitte nur mit einem Staubtuch oder leicht feuchtem Lappen reinigen. Keine scheuernden Putzmittel verwenden.
<b>GB</b>	Please only clean with a duster or a damp cloth. Do not use any abrasive cleaners.
<b>FR</b>	Veillez nettoyer uniquement avec un chiffon à poussière ou un chiffon légèrement humide. Ne pas utiliser de détergent abrasif.
<b>IT</b>	Si raccomanda di pulire solo con un panno per la polvere o uno strofinaccio umido. Non utilizzare detergenti abrasivi.
<b>NL</b>	Reinig alleen met een stofdoek of een lichtjes vochtige doek. Gebruik geen schurende poetsmiddelen.
<b>PL</b>	Czyszczenie należy wykonać wyłącznie za pomocą ściereczki lub lekko nawilżonego ręcznika. Nie stosować środków czyszczących do szorowania.
<b>CZ</b>	Čistěte prosím jen prachovkou nebo lehce navlhčeným hadrem. Nepoužívejte drhňoucí čisticí prostředky.
<b>SK</b>	Na čistenie používajte len prachovku alebo z ľahka navlhčenú utierku. Nepoužívajte žiadne drhňúce čistiace prostriedky.
<b>HU</b>	Kérjük, csak portörli ó kendővel vagy enyhén nedves ronggyal tisztítsa. Ne használjon dörzsztátású tisztítószeret.
<b>RO</b>	Vă rugăm să utilizați la curățare exclusiv o cârpă de șters praful sau o cârpă ușor umezită. Nu utilizați substanțe de curățat abrazive.
<b>TR</b>	Lütfen sadece bir toz beziiyle veya hafif nemli yumu şak bir bezle siliniz. A şındırıcı temizlik malzemeleri kullanmayınız.
<b>RU</b>	Очищайте от пыли тряпкой или слегка влажной ветошью. Не допускается применение чистящих средств, не предназначенных для ухода за мебелью.