

APULIA V  
8141/2500/8300  
8100/2500/8142

- |           |  |           |   |
|-----------|--|-----------|---|
| <b>D</b>  | MONTAGEANLEITUNG<br>BEDIENUNGSANLEITUNG                | <b>GB</b> | ASSEMBLY INSTRUCTIONS<br>INSTRUCTION MANUAL         |
| <b>NL</b> | HANDLEIDING VOOR DE MONTAGE<br>GEBRUIKSAANWIJZING      | <b>PL</b> | INSTRUKCJA MONTAŻU<br>INSTRUKCJA OBSŁUGI            |
| <b>TR</b> | MONTAJ TALIMATI<br>KULLANIM KLAVUZU                    | <b>RU</b> | ИНСТРУКЦИЯ ПО МОНТАЖУ<br>ИНСТРУКЦИЯ ПО ЭКСПЛУАТАЦИИ |
| <b>RO</b> | INSTRUCȚIUNI DE INSTALARE<br>INSTRUCȚIUNI DE UTILIZARE | <b>IT</b> | ISTRUZIONI DI MONTAGGIO<br>MANUALE DI ISTRUZIONI    |
| <b>FR</b> | NOTICE DE MONTAGE<br>MANUEL INSTRUCTIONS               | <b>SK</b> | MONTÁŽNY NÁVOD<br>NÁVOD NA POUŽITIE                 |
| <b>HU</b> | KÖZGYŰLÉS UTASÍTÁSOK<br>KEZELÉSI UTASÍTÁS              | <b>CZ</b> | MONTÁŽNÍ NÁVOD<br>NÁVOD K POUŽITÍ                   |
| <b>SI</b> | NAVODILA ZA MONTAŽO<br>NAVODILA ZA UPORABO             | <b>PT</b> | INSTRUÇÕES DE MONTAGEM<br>MANUAL DO USUÁRIO         |
| <b>ES</b> | INSTRUCCIONES DE MONTAJE<br>MANUAL DEL USUARIO         | <b>HR</b> | UPUTE ZA MONTAŽU<br>UPUTE ZA UPOTREBU               |

**F/B**

220501

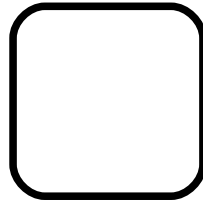
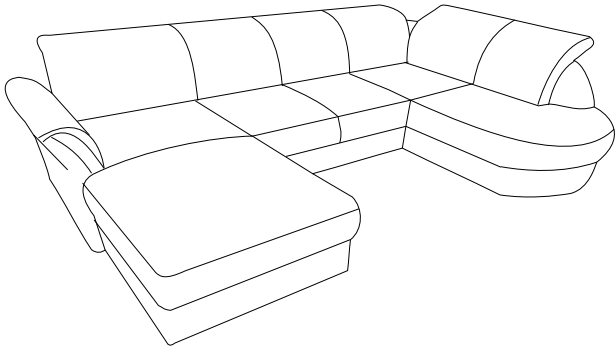
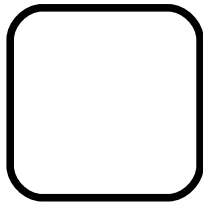

0019

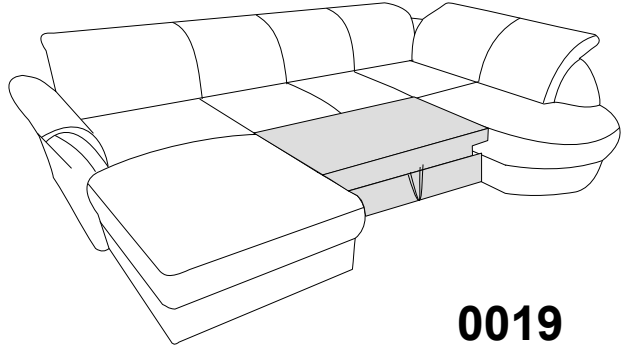

0019

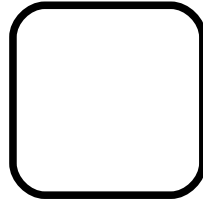
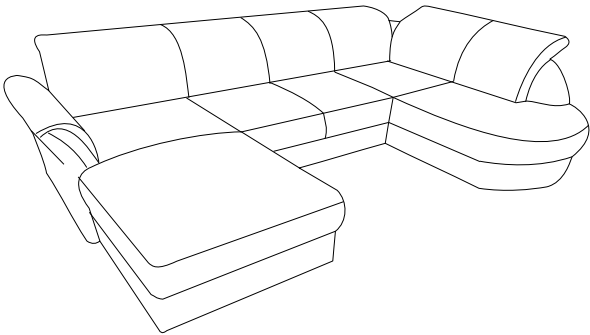
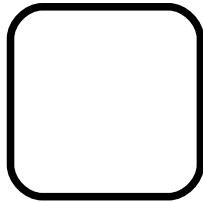

0089

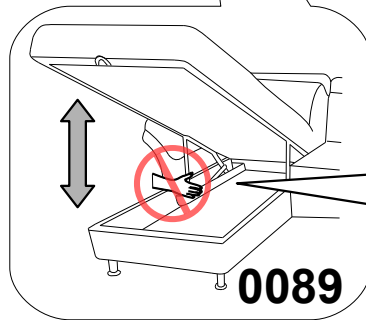
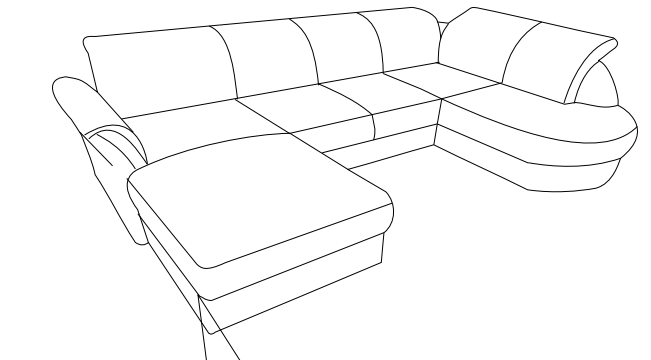
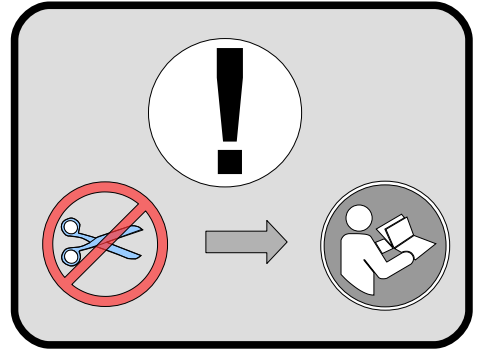

0089



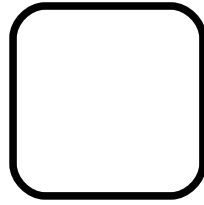
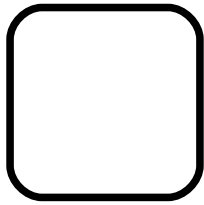

0064

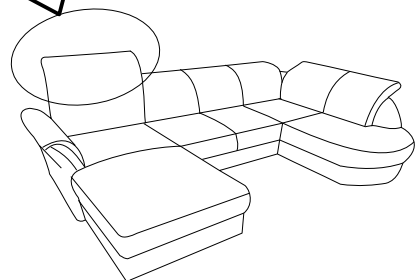
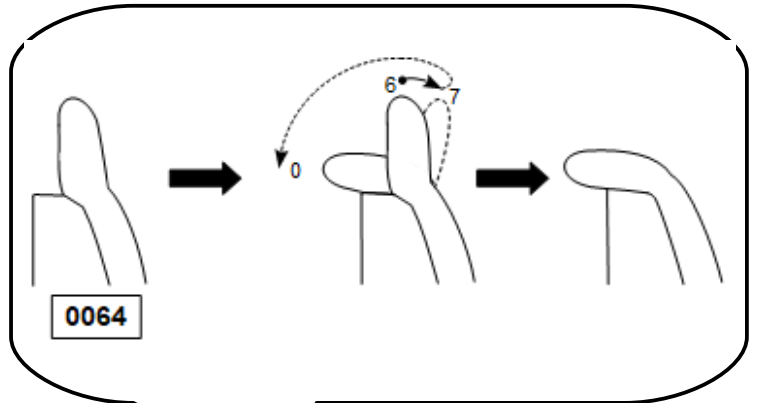
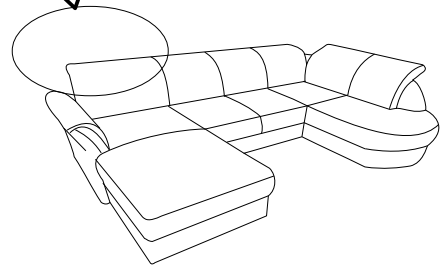
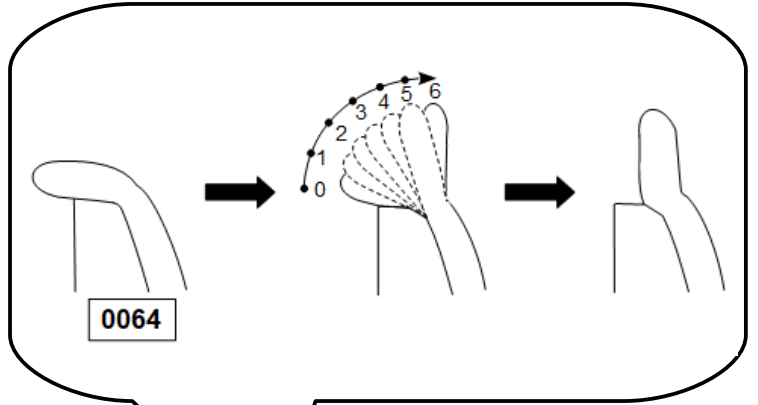
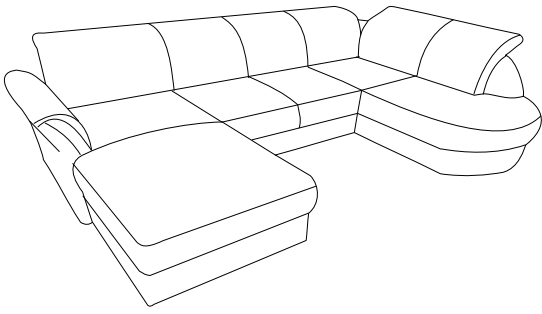

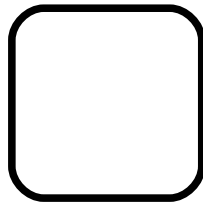
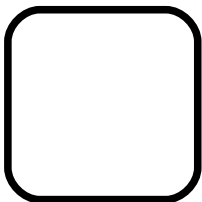

0090

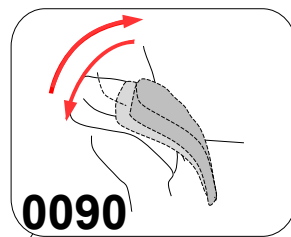

0090

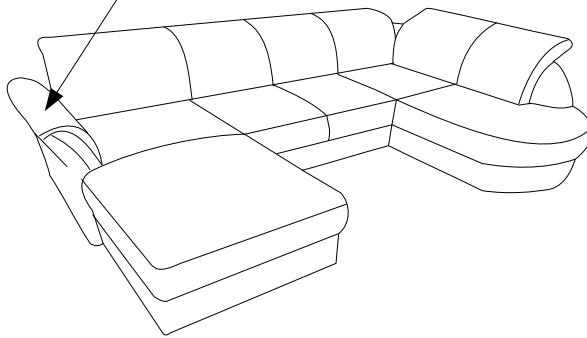
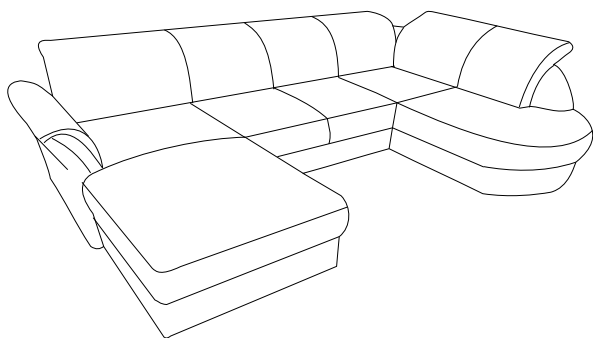

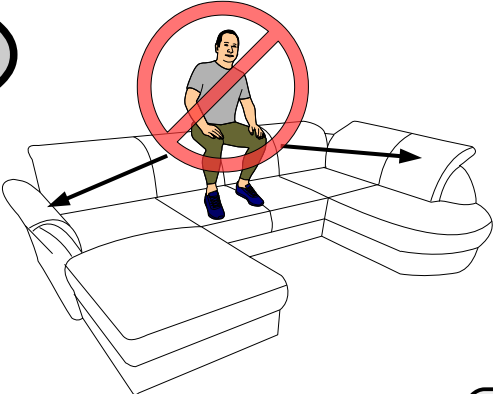

L



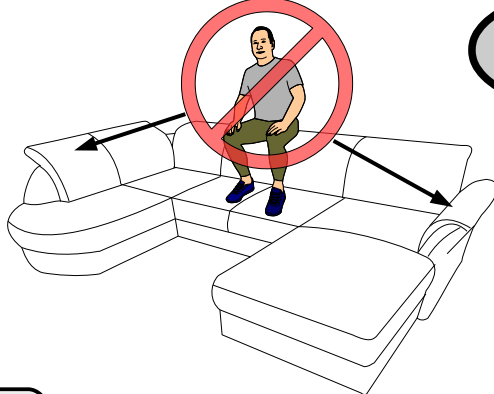

R



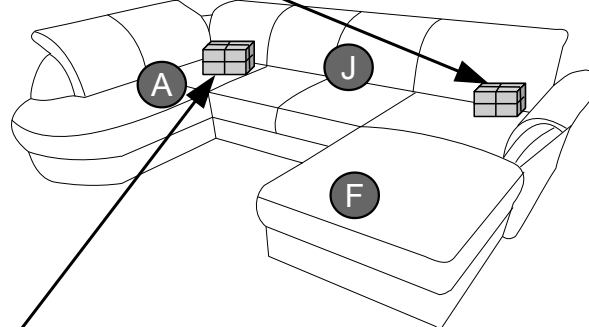
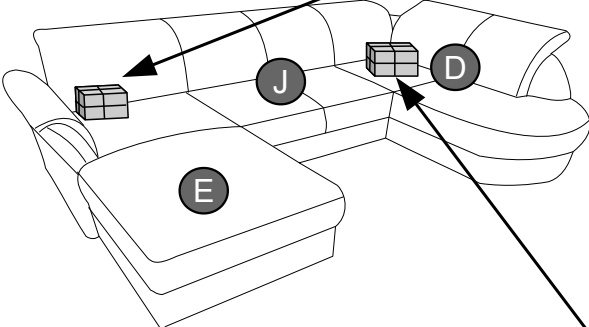

<b>s</b> H-90  X3	<b>g</b> H-90  X1	[mm]
--	--	------

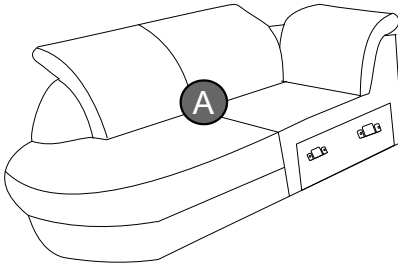
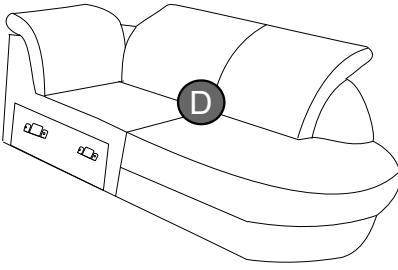
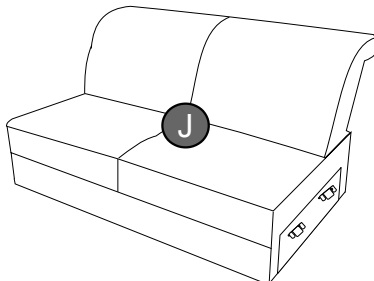
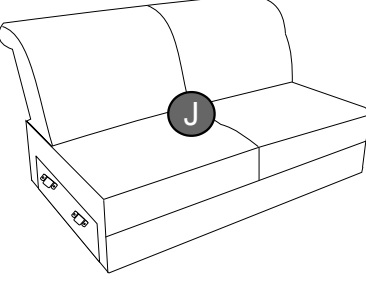
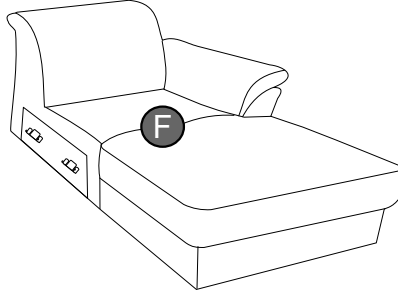
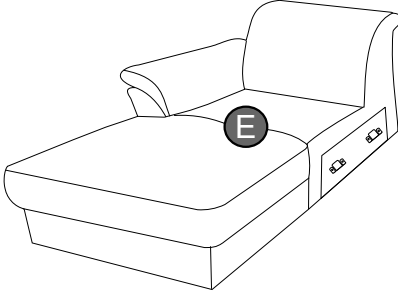

<b>s</b> H-90  X4	<b>g</b> H-90  X3
--	--

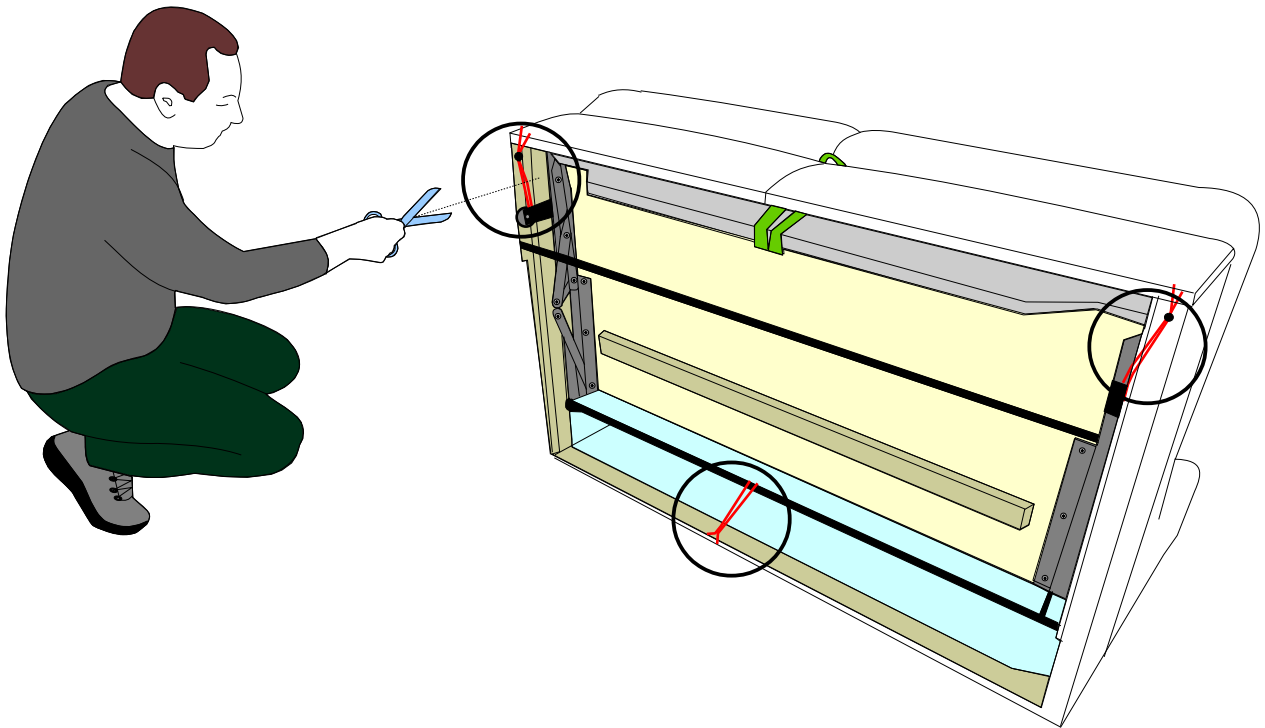
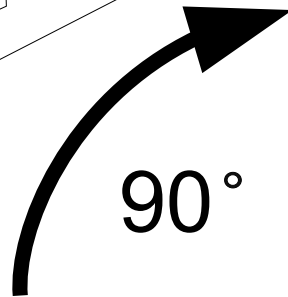
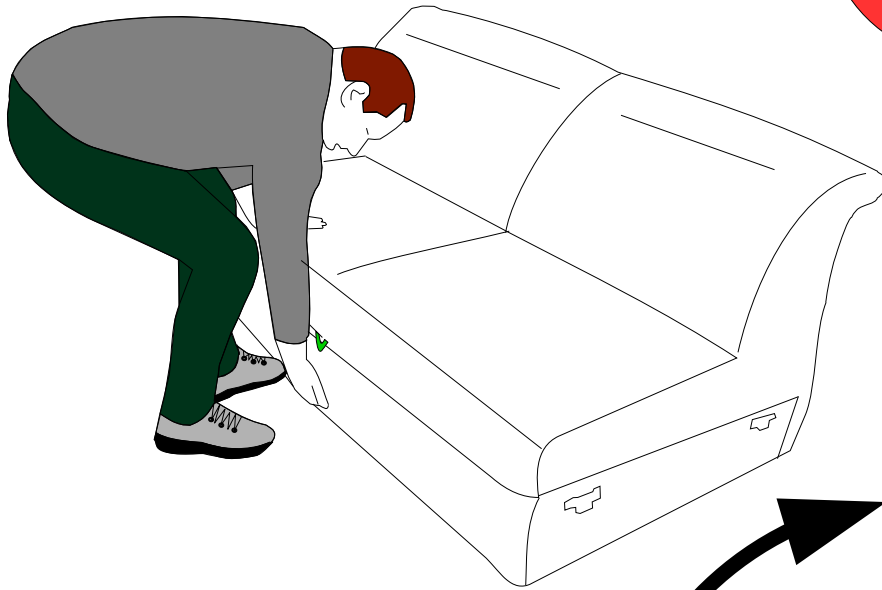



<b>s</b> H-90  X7	<b>g</b> H-90  X4
---	---

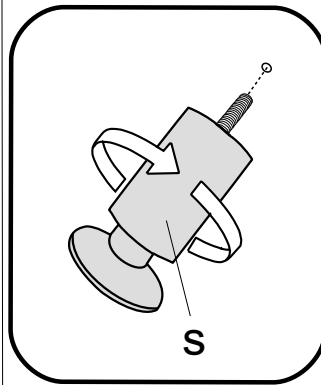
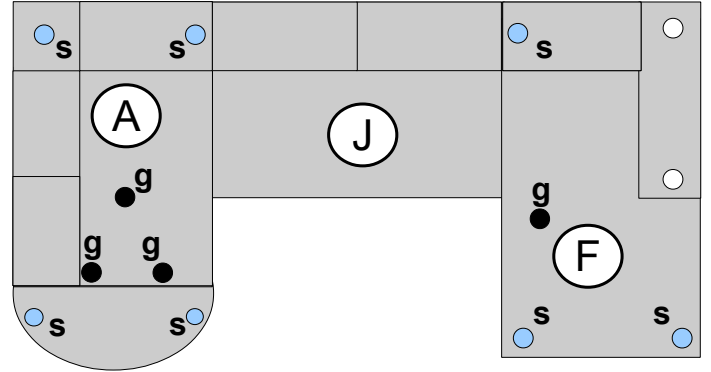
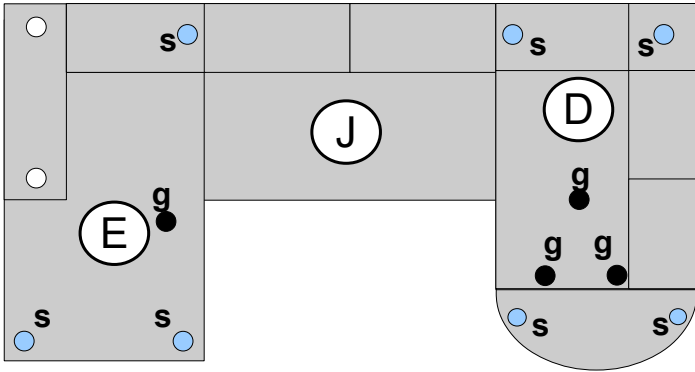
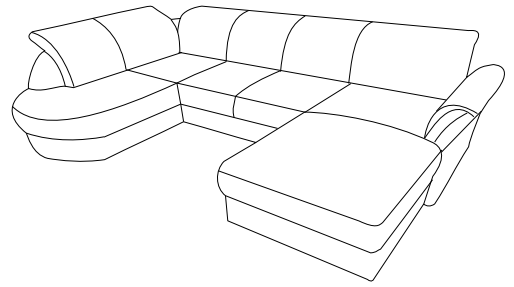
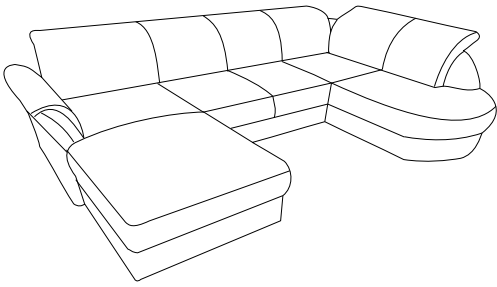

Detailed assembly instructions for the 'g' screwdriver. The main diagram shows the 'g' screwdriver with a 'Click-knop Adjustable' knob and a height of 90 mm. It includes a warning icon (exclamation mark) and a correct usage diagram (hand holding the screwdriver) with a checkmark. A diagram shows the correct placement of the screwdriver on the sofa base, with a red 'X' indicating an incorrect placement.

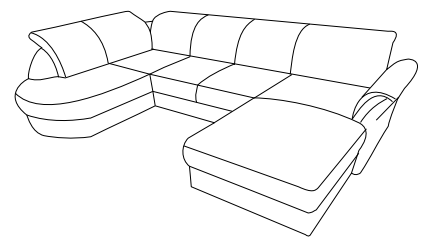
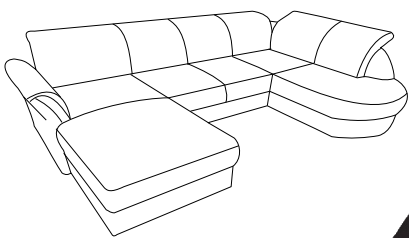
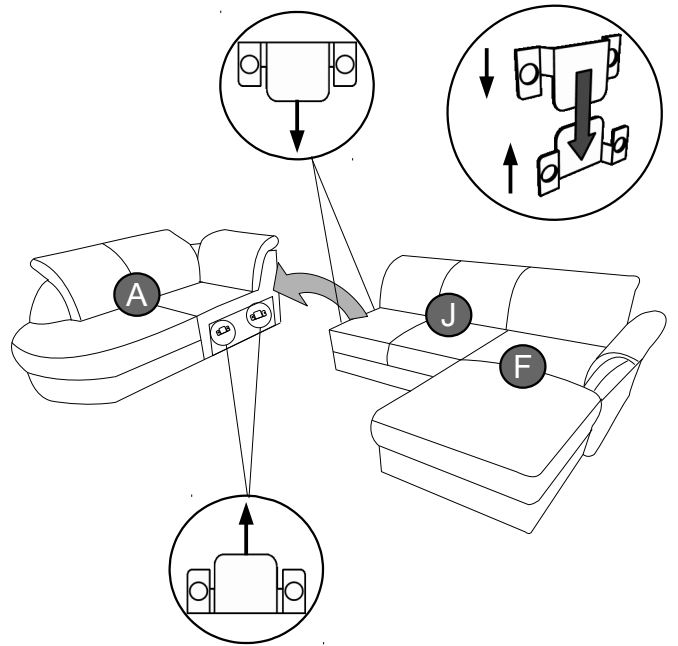
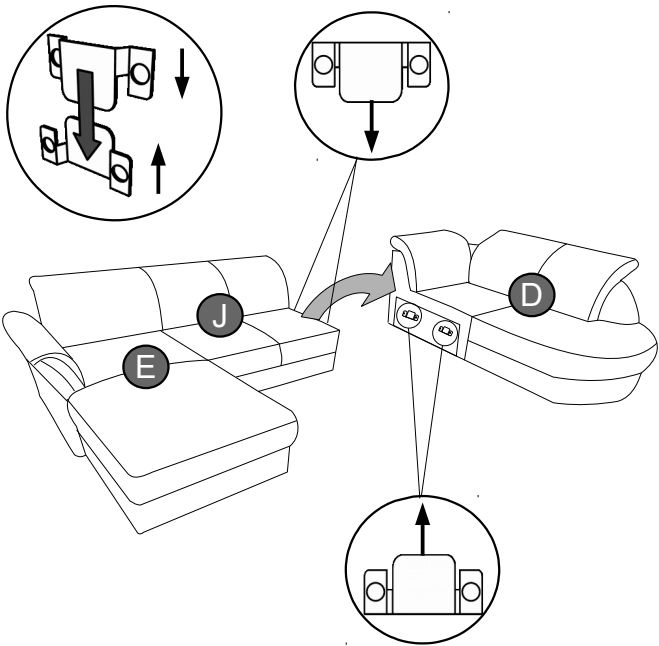
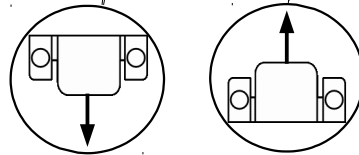
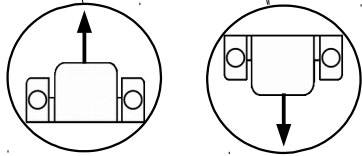
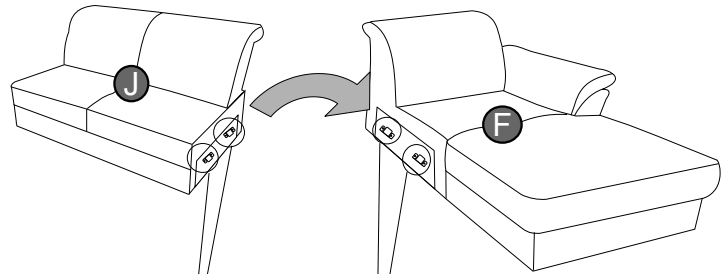
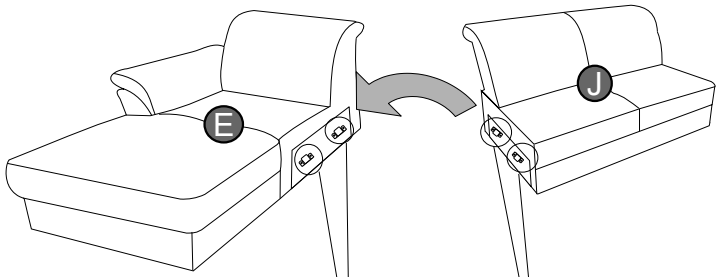
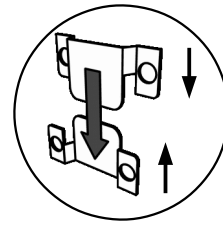
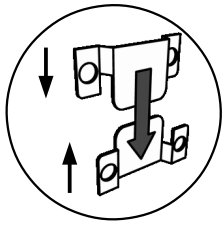
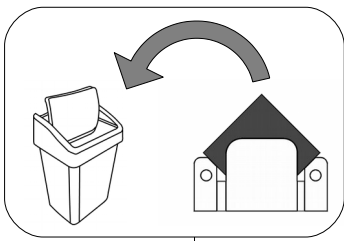



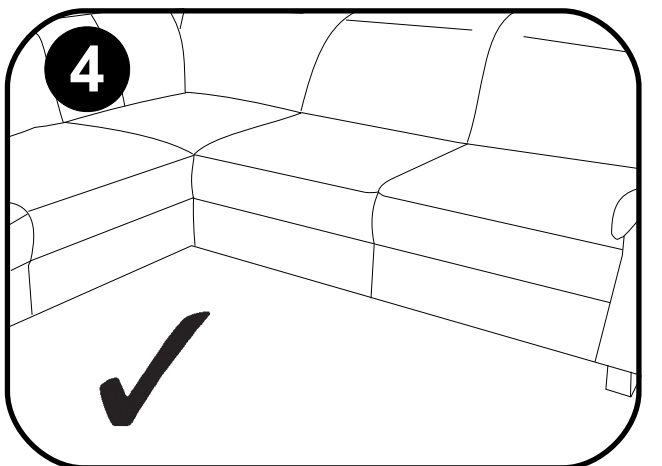
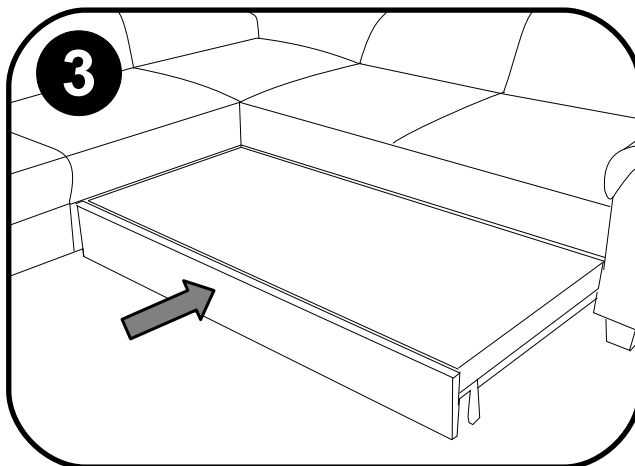
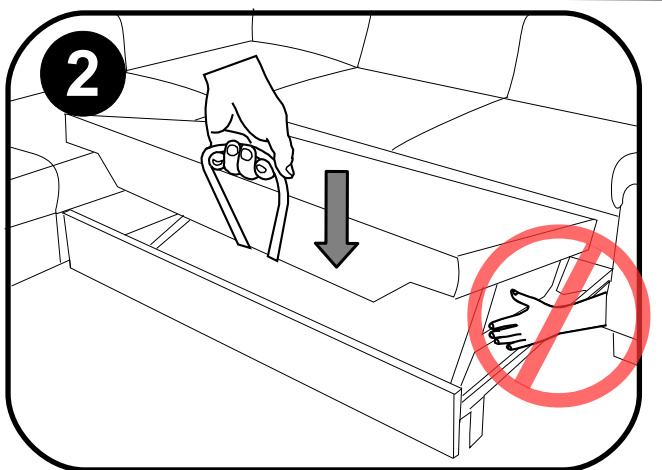
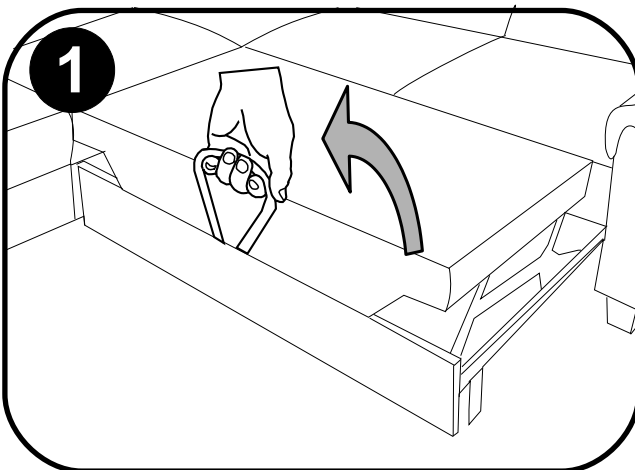
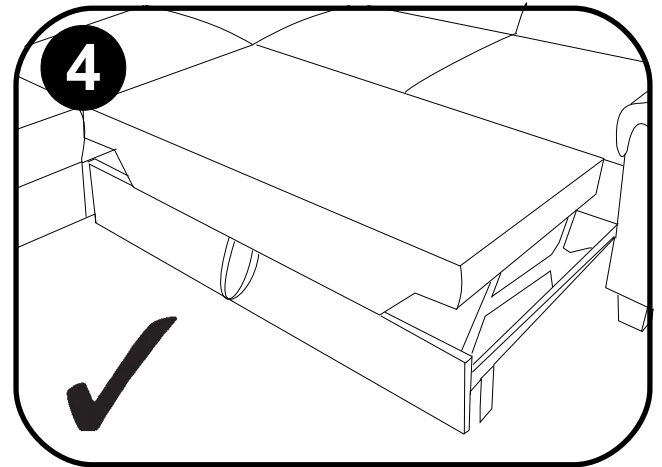
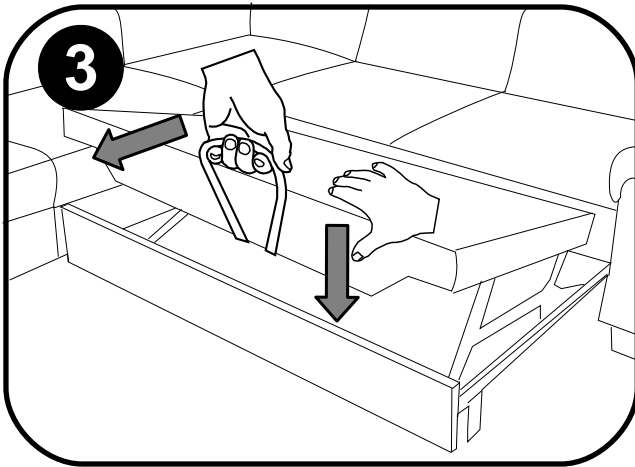
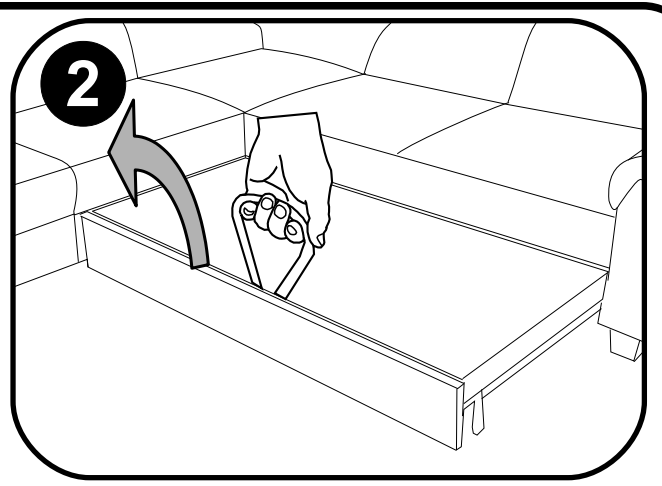
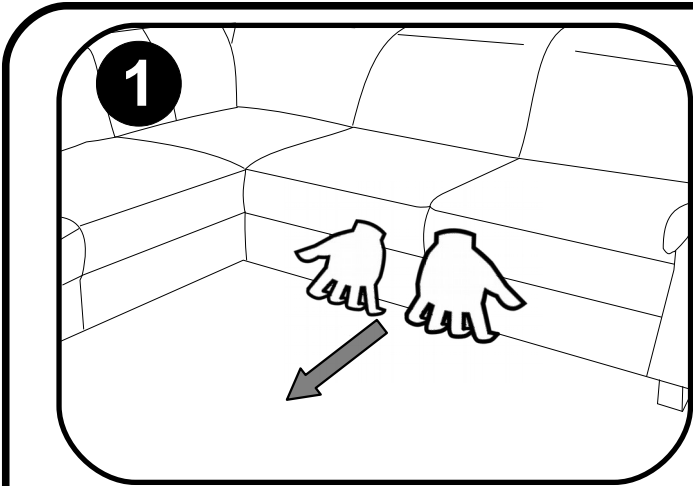
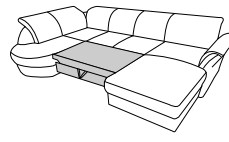
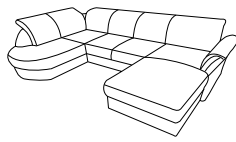

Name · Naam · Nazwa · Ísim · Название · Nume · Nome · Názov · Názov ·  
 Název · Neve

**APULIA V**

Typ · Type · Tip · Тип · Tipo · Típus

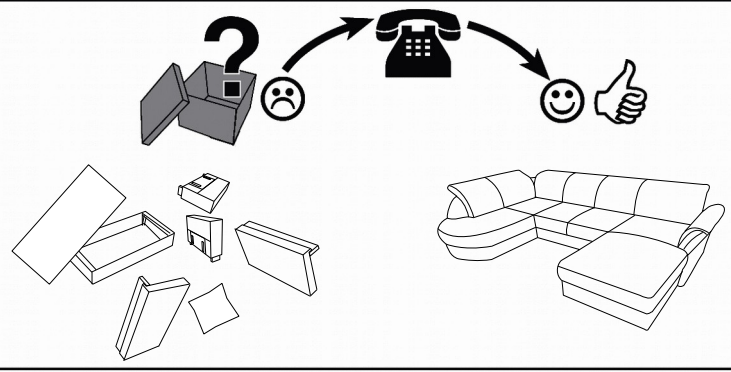
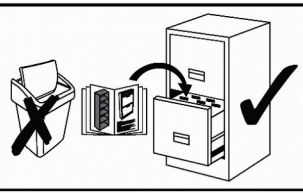

**L**

**R**

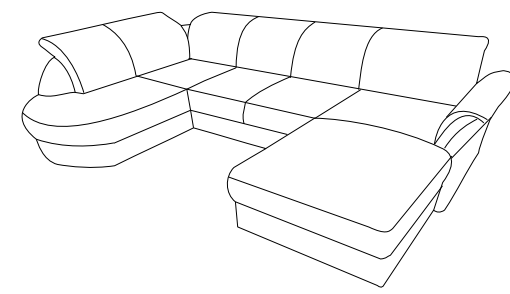
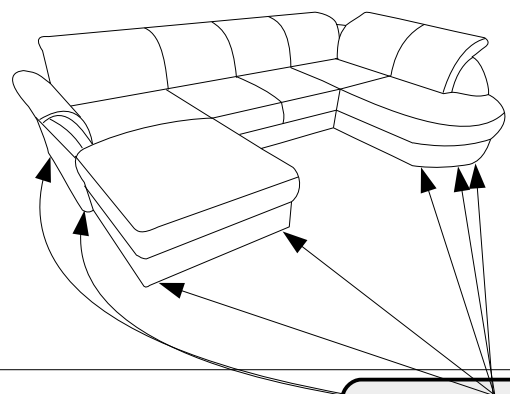

<b>Z</b> H-26 	<b>S</b> H-90 	<b>g</b> H-90 	[mm]
-------------------	-------------------	-------------------	------

