

SOJAG

produits saisonniers • seasonal products

Sojag code: 999-8163223

CUP/UPC code: 772831063223

Assembly Manual / Guide d'assemblage / Manual de ensamblaje / 조립 설명서 / Montageanleitung

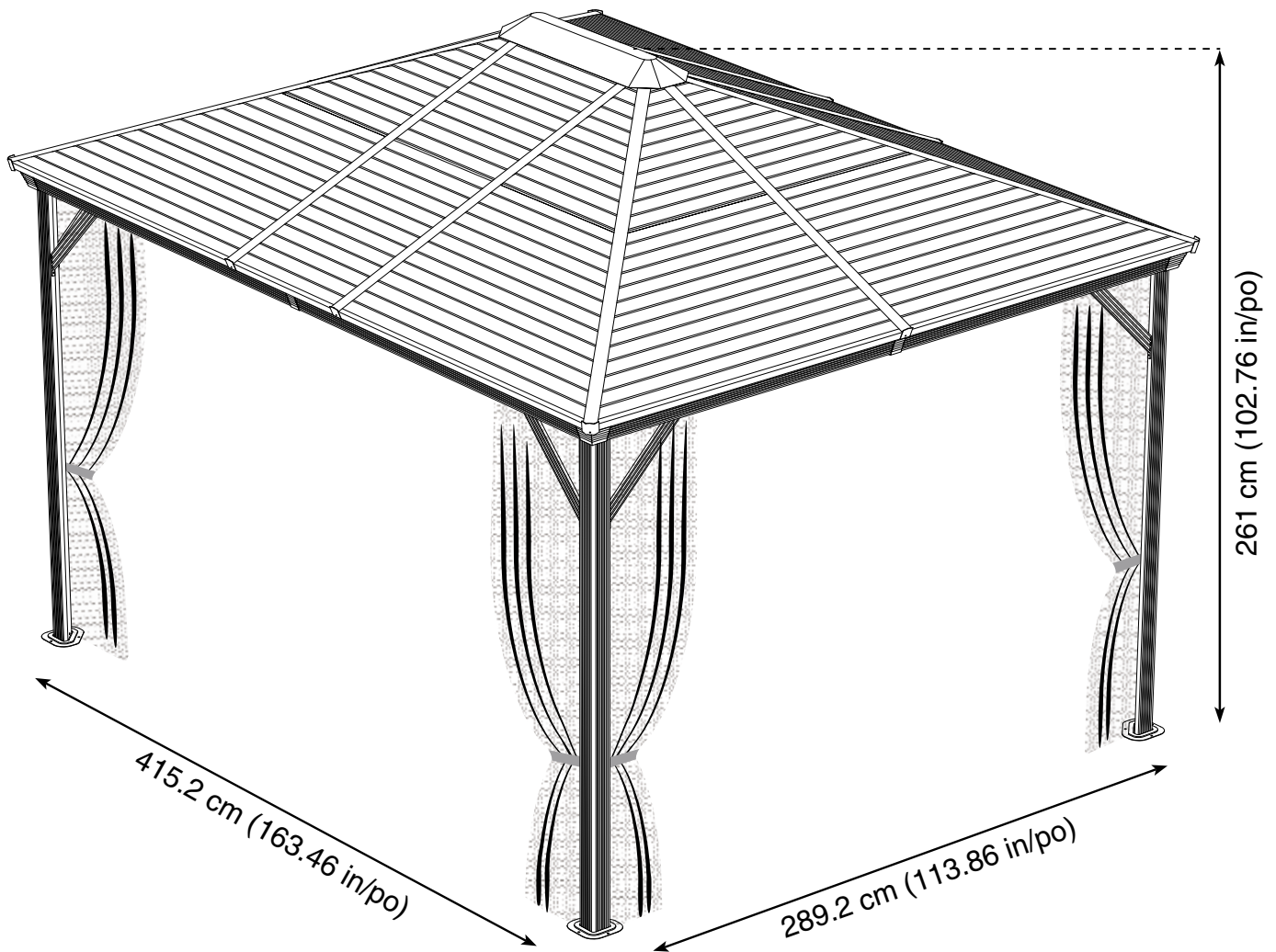



Use the hex keys in the box. / Utilisez les clés hexagonales fournies dans la boîte. /
Utilice las llaves hexagonales en la caja. / 상자에 육각 키를 사용 하십시오. / Verwenden Sie
die Sechskantschlüssel in der Box.

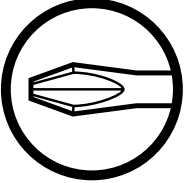

Please use a Phillips screwdriver period / Utilisez un tournevis de type Phillips / Por favor,
use un destornillador Phillips / 십자 드라이버를 사용 하십시오. / Bitte verwenden Sie einen
Kreuzschraubenzieher.



you may need to use a drill for this step. / Vous pouvez avoir besoin d'utiliser une
perceuse pour cette étape. / puede que tenga que utilizar un taladro para este paso. /
이 단계에선 드릴을 사용해야 할 수도 있습니다. / Für diesen Schritt können Sie einen
Bohrer verwenden.



Wearing protective gloves is recommended. / Le port de gants de protection est recommandé /
El uso de guantes de protección se recomienda / 보호 장갑을 착용 하는 것이 좋습니다. /
Das Tragen von Schutzhandschuhen wird empfohlen.



Two or more people are required at this stage. / Deux personnes ou plus sont nécessaires à cette
étape. / Dos o más personas se requieren en esta etapa. / 이 단계에서는 두 명 이상이 필요합니다. /
Für diesen Bauschritt sind 2 oder mehr Personen erforderlich.



Do not screw firmly for now. / Ne pas visser fermement pour l'instant. / No atornille con
firmeza por ahora. / 아직 나사를 단단히 조이지 마십시오. / Bitte die Schrauben zum
jetzigen Zeitpunkt noch nicht fest anziehen.



Sold separately / Vendus séparément / vendido en las opciones /
옵션 판매 / Optional erhältlich

T X 8 (+2)

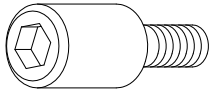

U X 16 (+2)

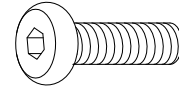

U1 X 20 (+5)



U2 X 2 (+1)

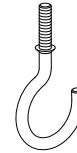

U3 X 1 (+1)

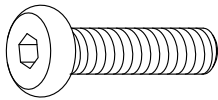

V X 92 (+10)

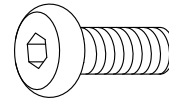

V1 X 16 (+2)

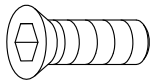

V2 X 20 (+2)

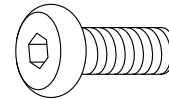

W X 34 (+4)

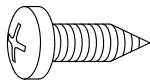

W1 X 16 (+2)

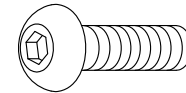



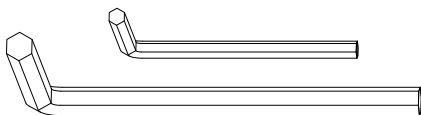



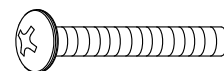

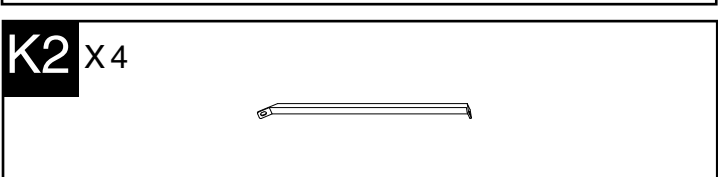
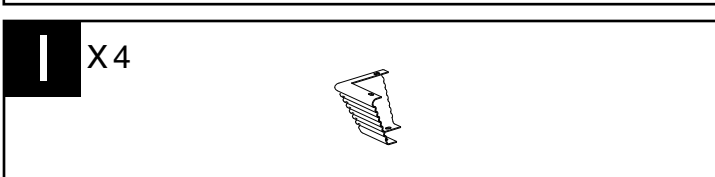
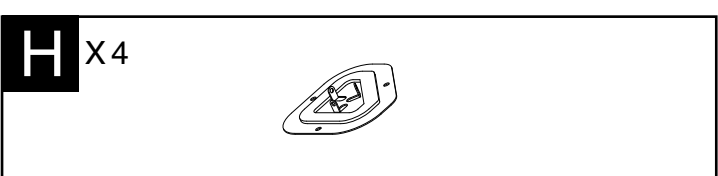
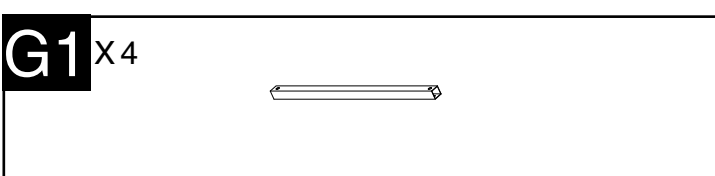
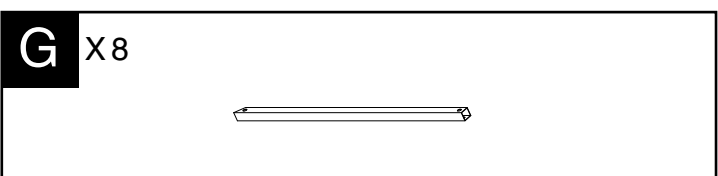
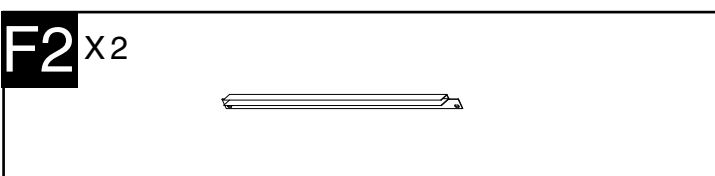
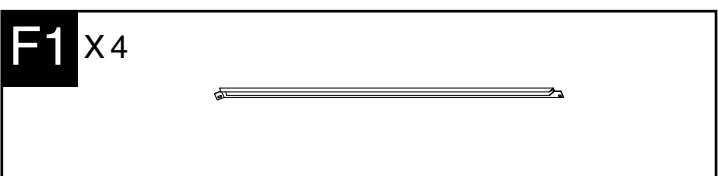
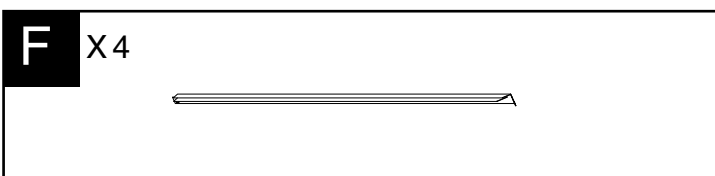
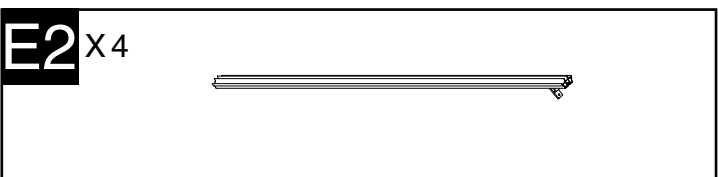
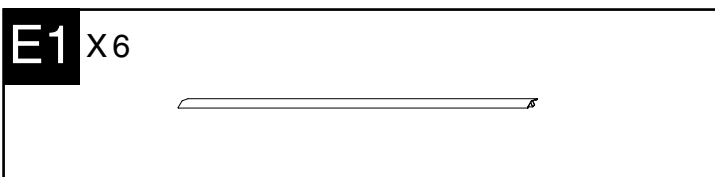
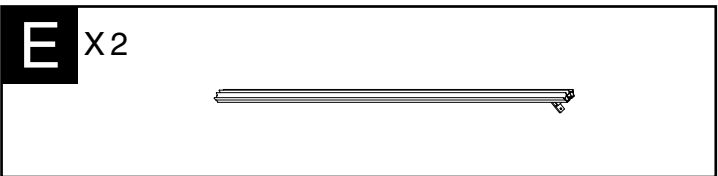
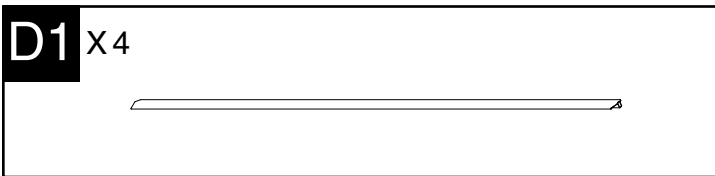
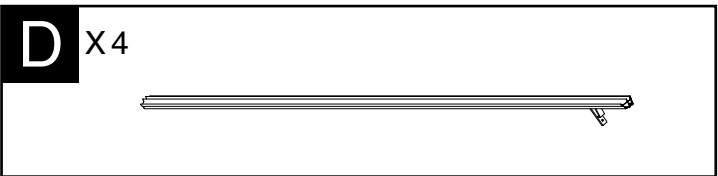
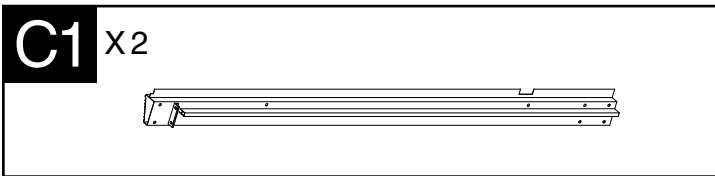
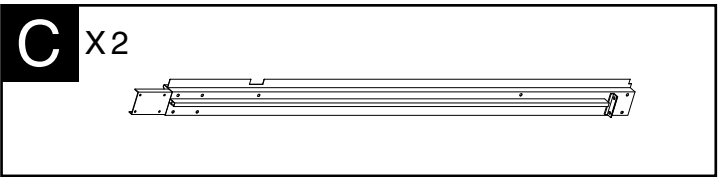
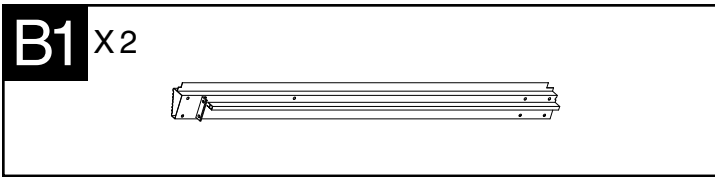
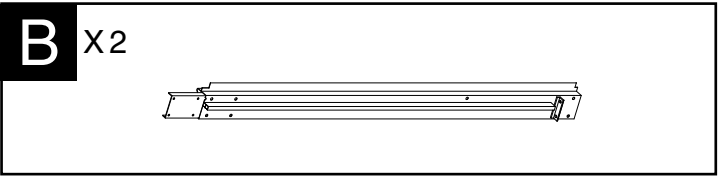

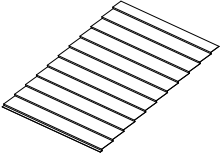
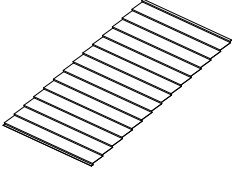
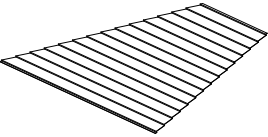
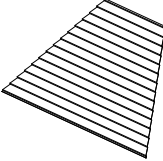
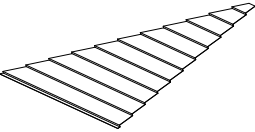
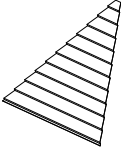
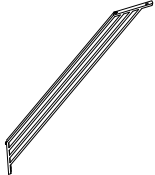

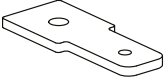



Y X 1

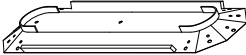

Y1 X 44 (+4)

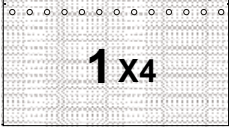

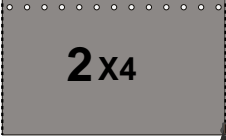

| | | |
|--|--|---|
| J X2  | J1 X2  | |
| N X4  | N1 X4  | |
| O X4  | O1 X4  | |
| K X8  | L X4  | |
| M2 X4  | M3 X6  | M4 X4  |
| Q X4  | R X6  | S X1  |
| S1 X1  | X X56 optional    | |
| Net  1 X4  | Curtain  2 X4  | |

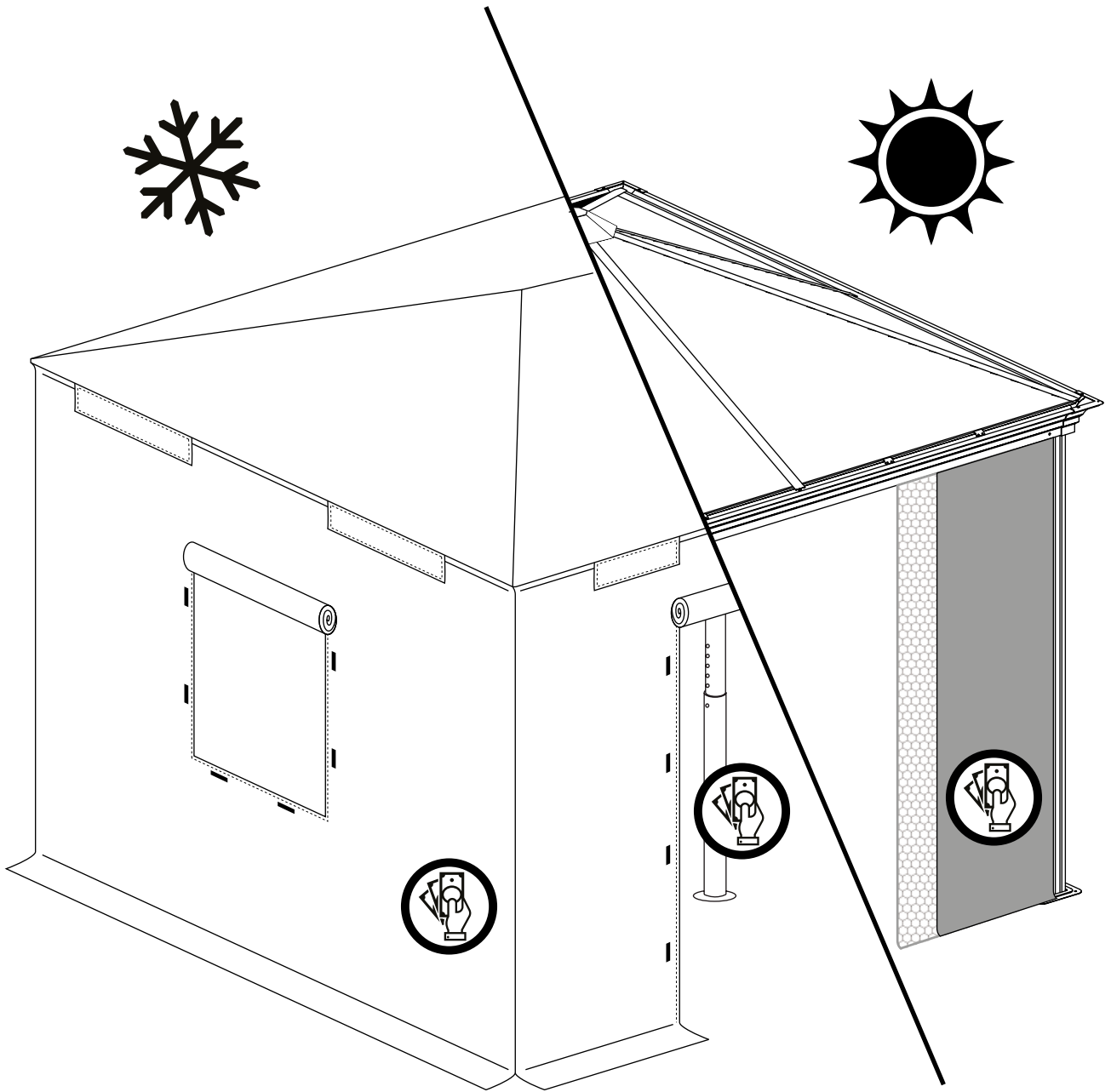
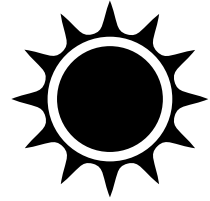
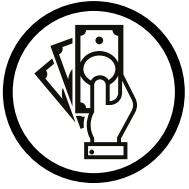

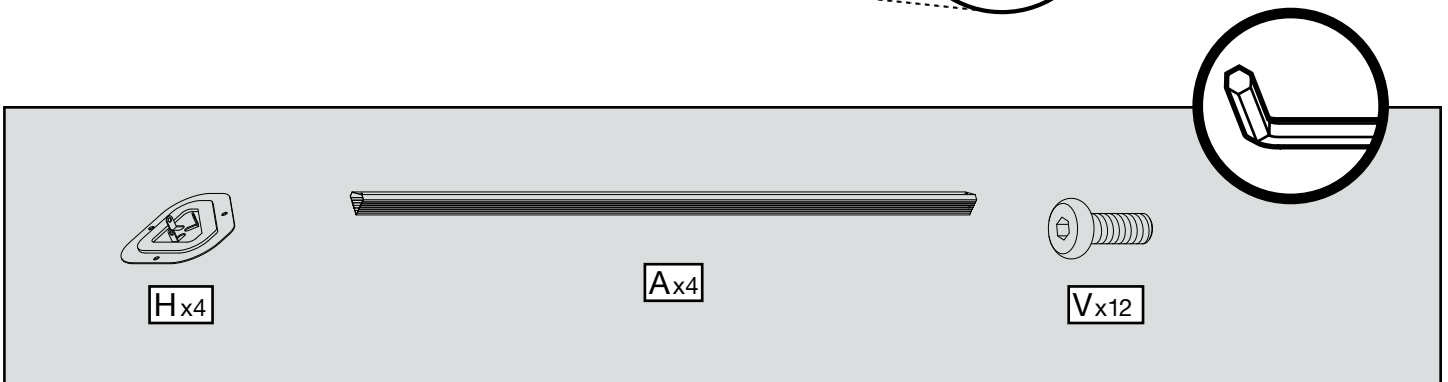
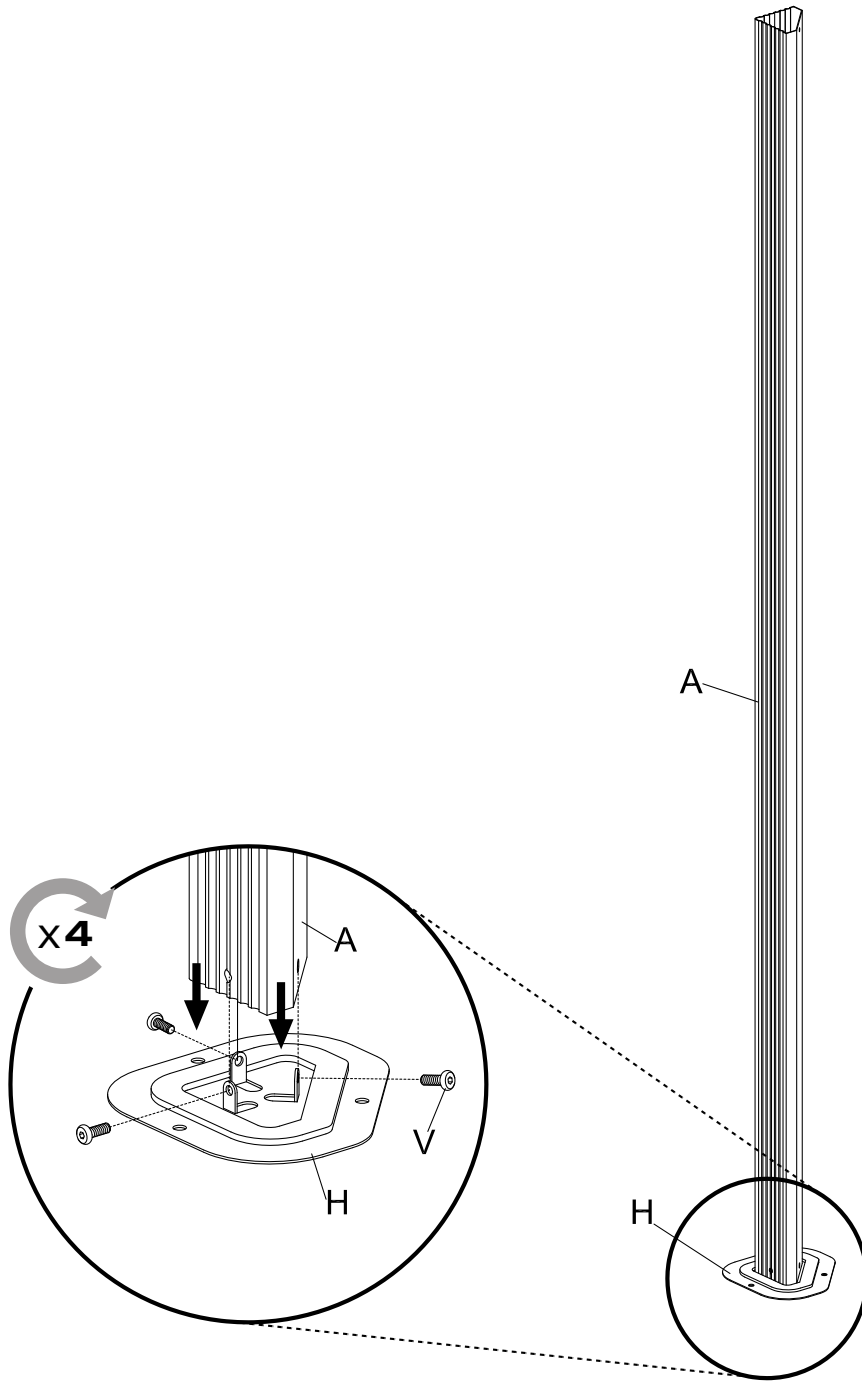

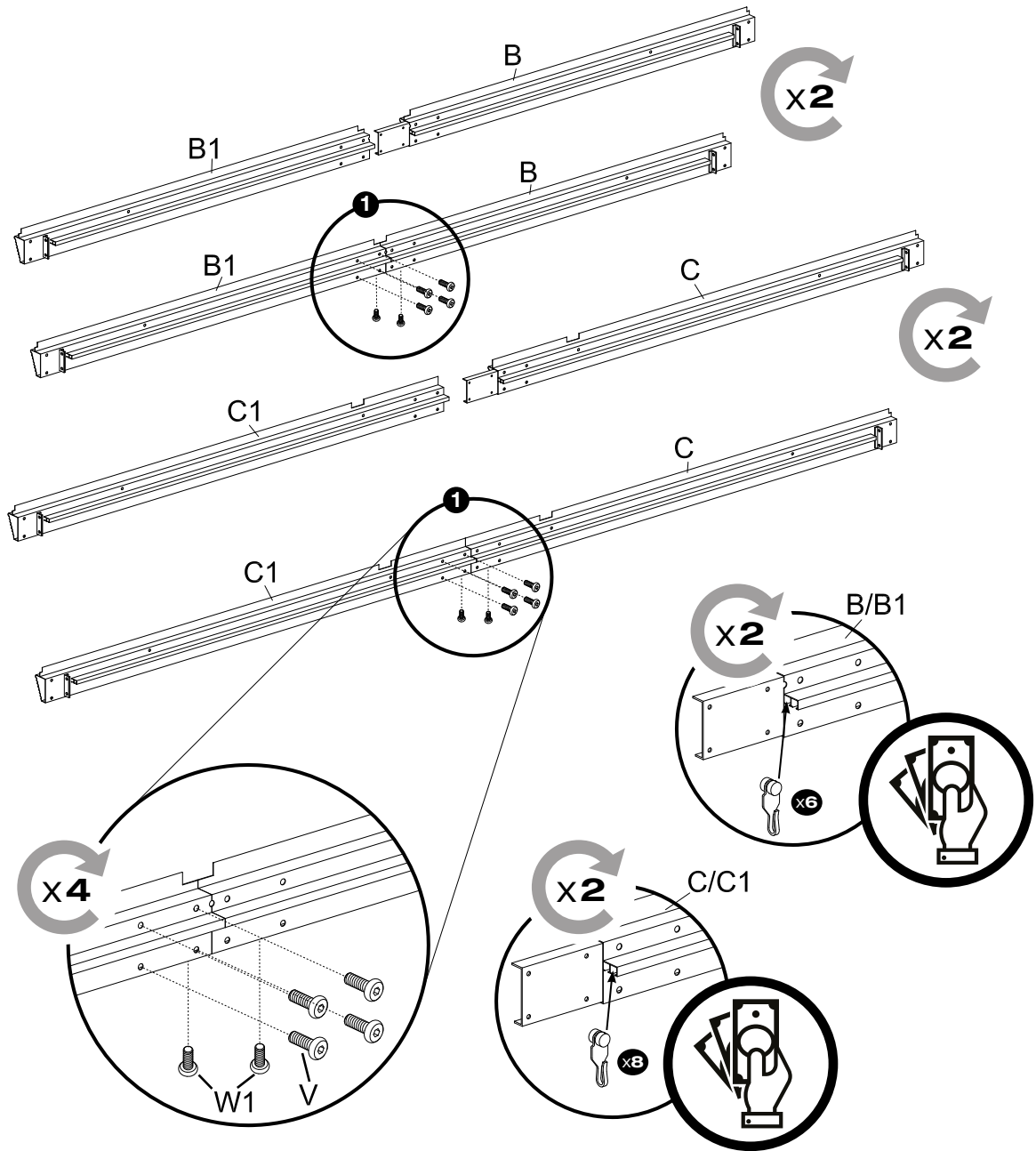

| | | | |
|----------|----------|----------|----------|
| Bx2 | Cx2 | | |
| B1x2 | C1x2 | | |
| Vx16 | | W1x8 | Xx56 |
| | | | Xx56 |

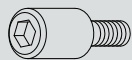
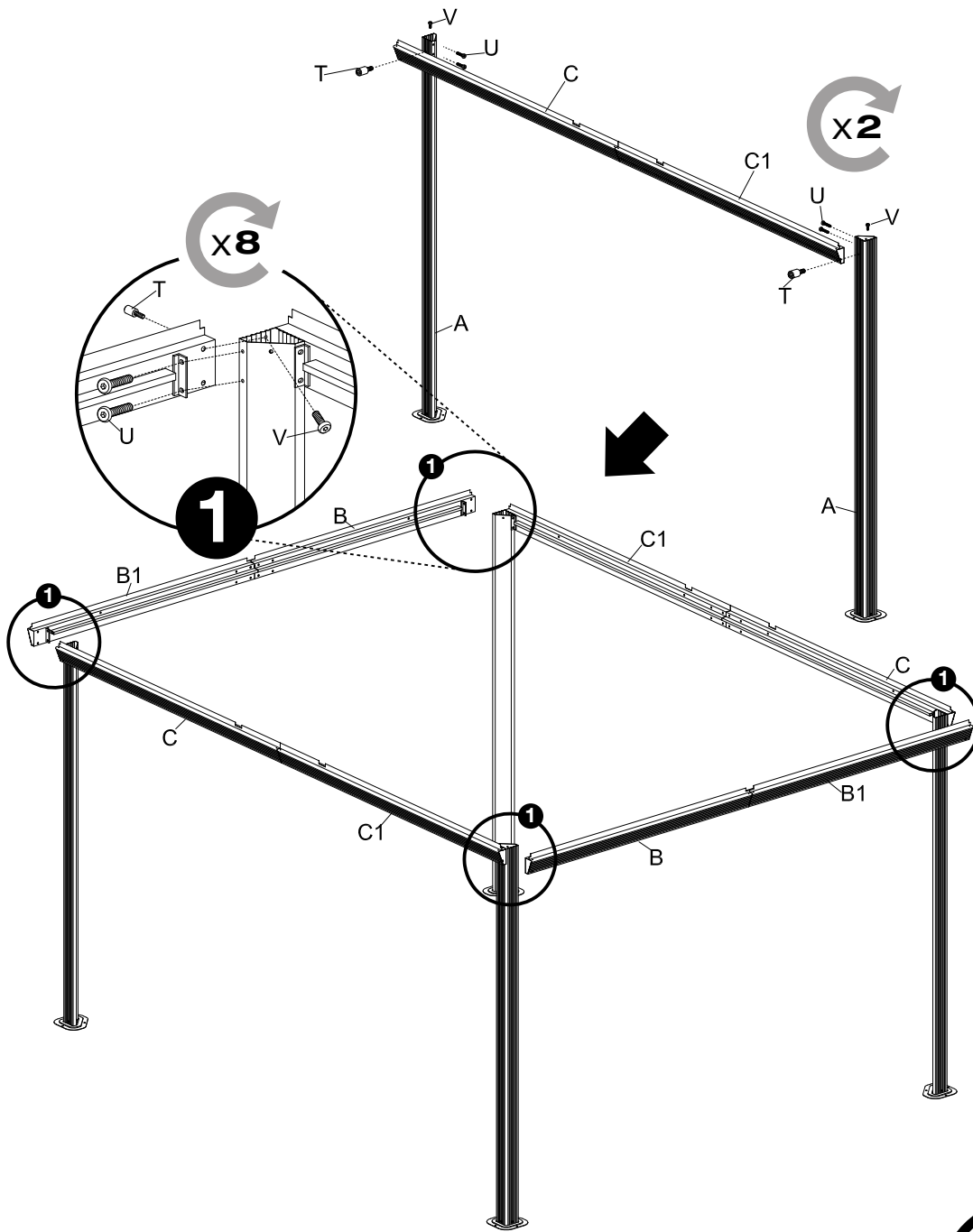

Tx8

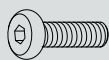

Ux16

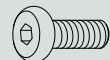

Vx8

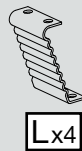
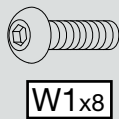
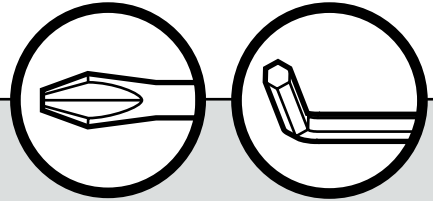
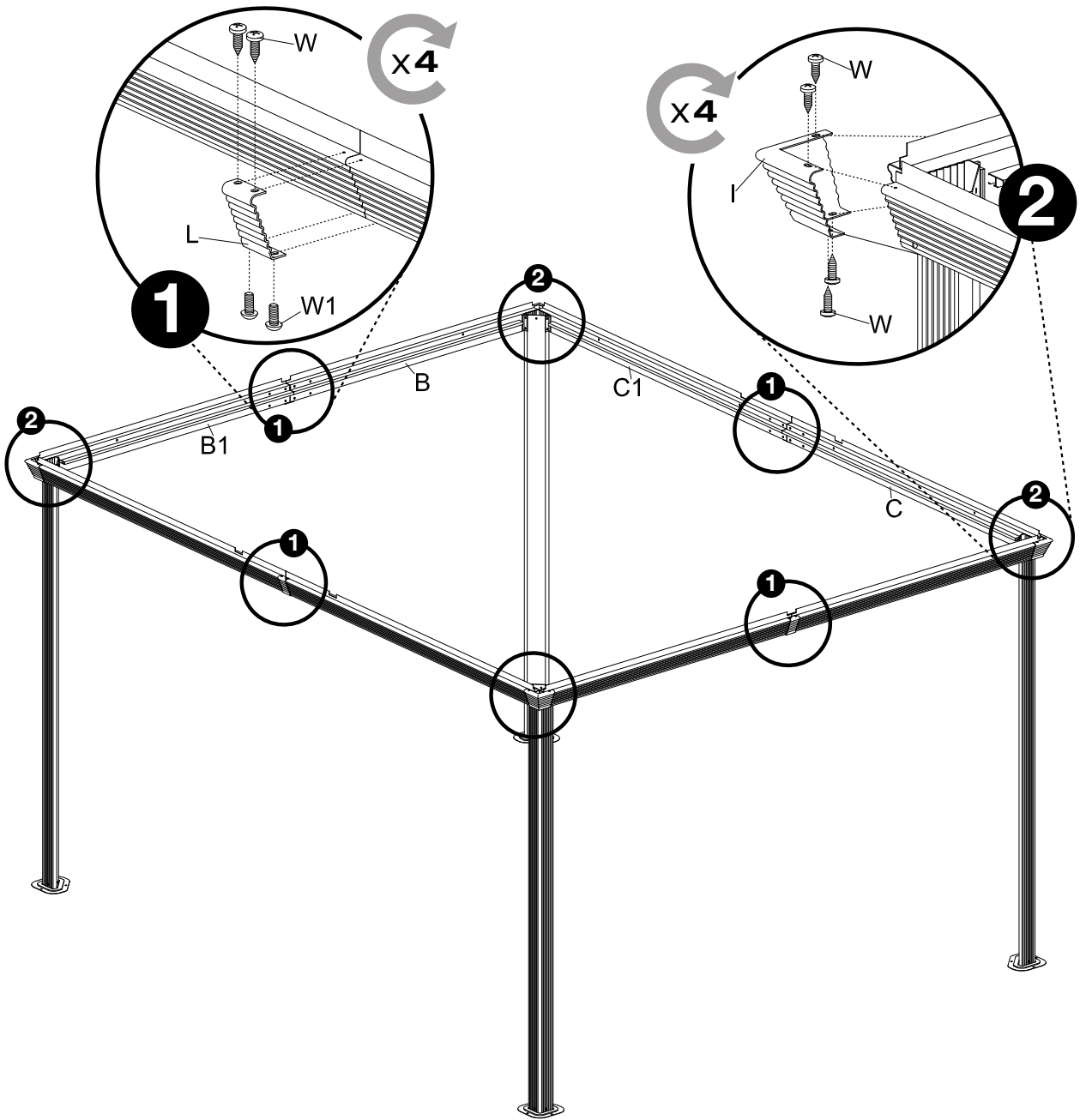

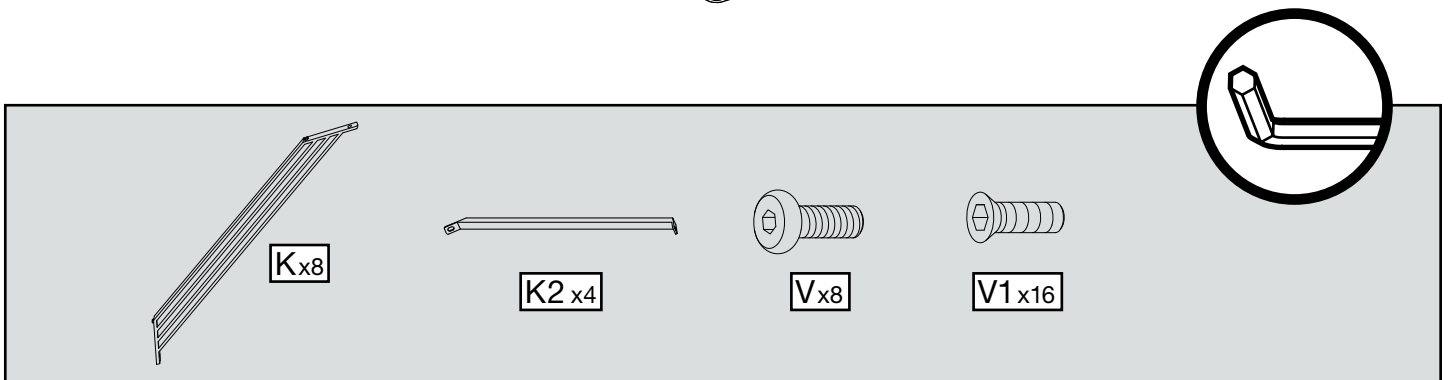
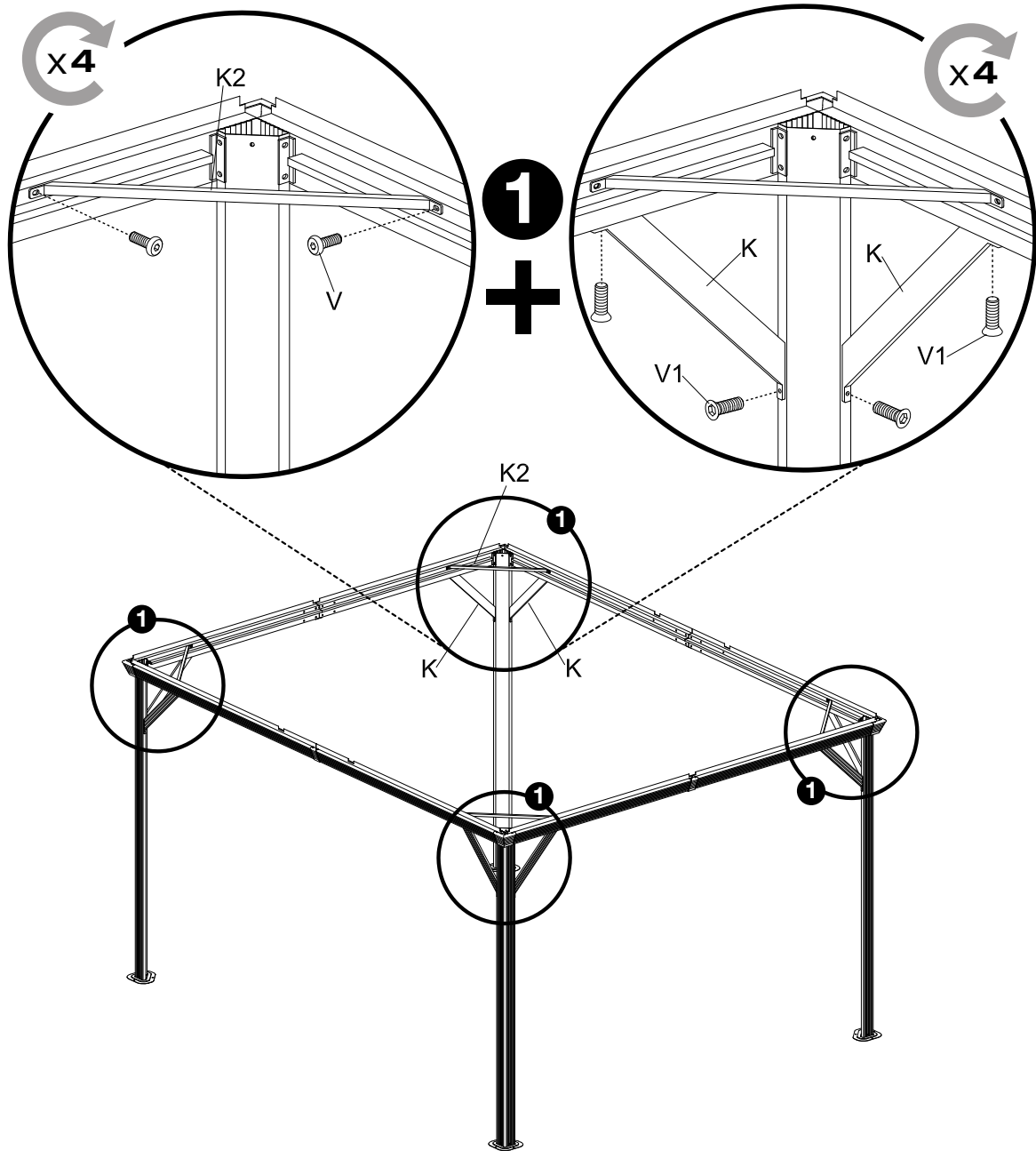

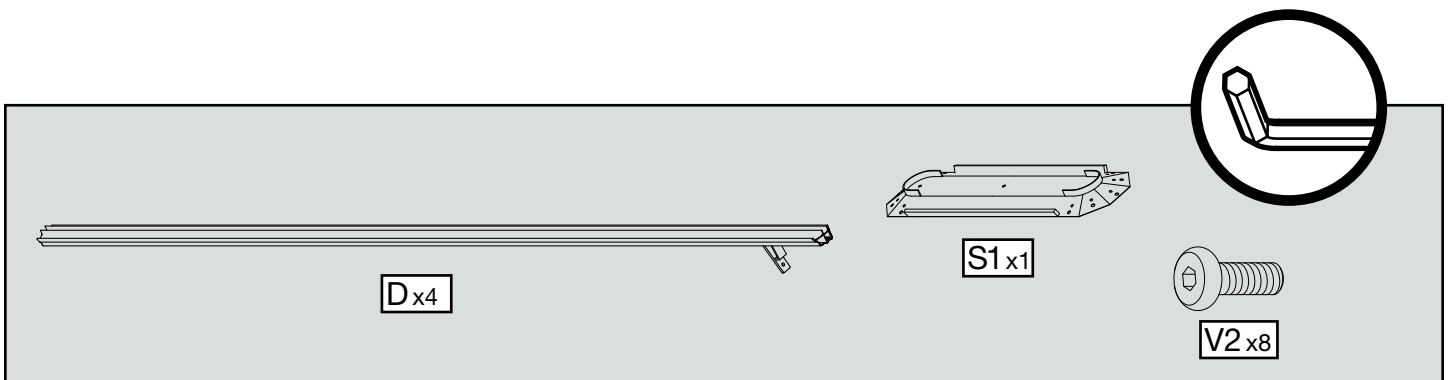
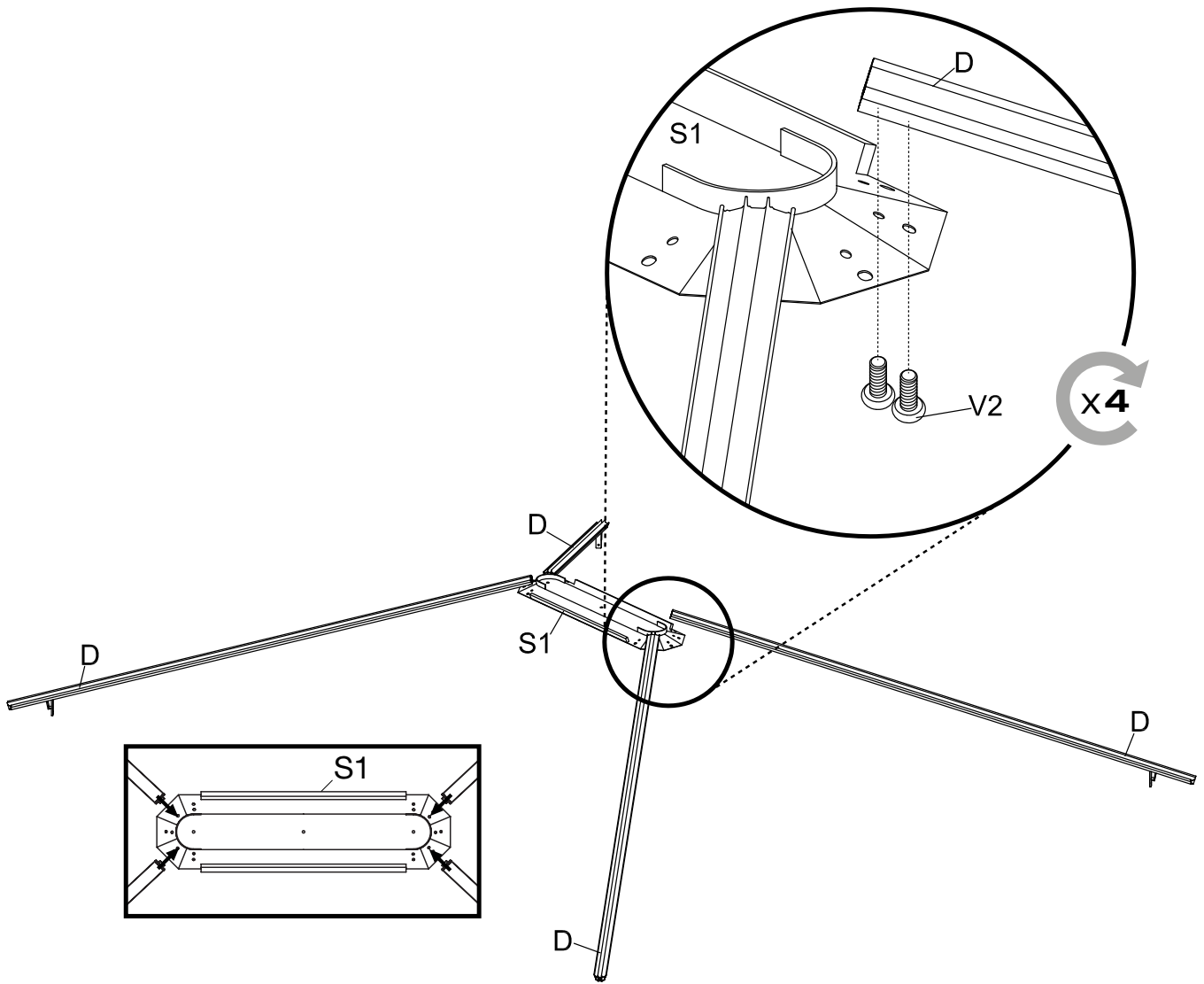

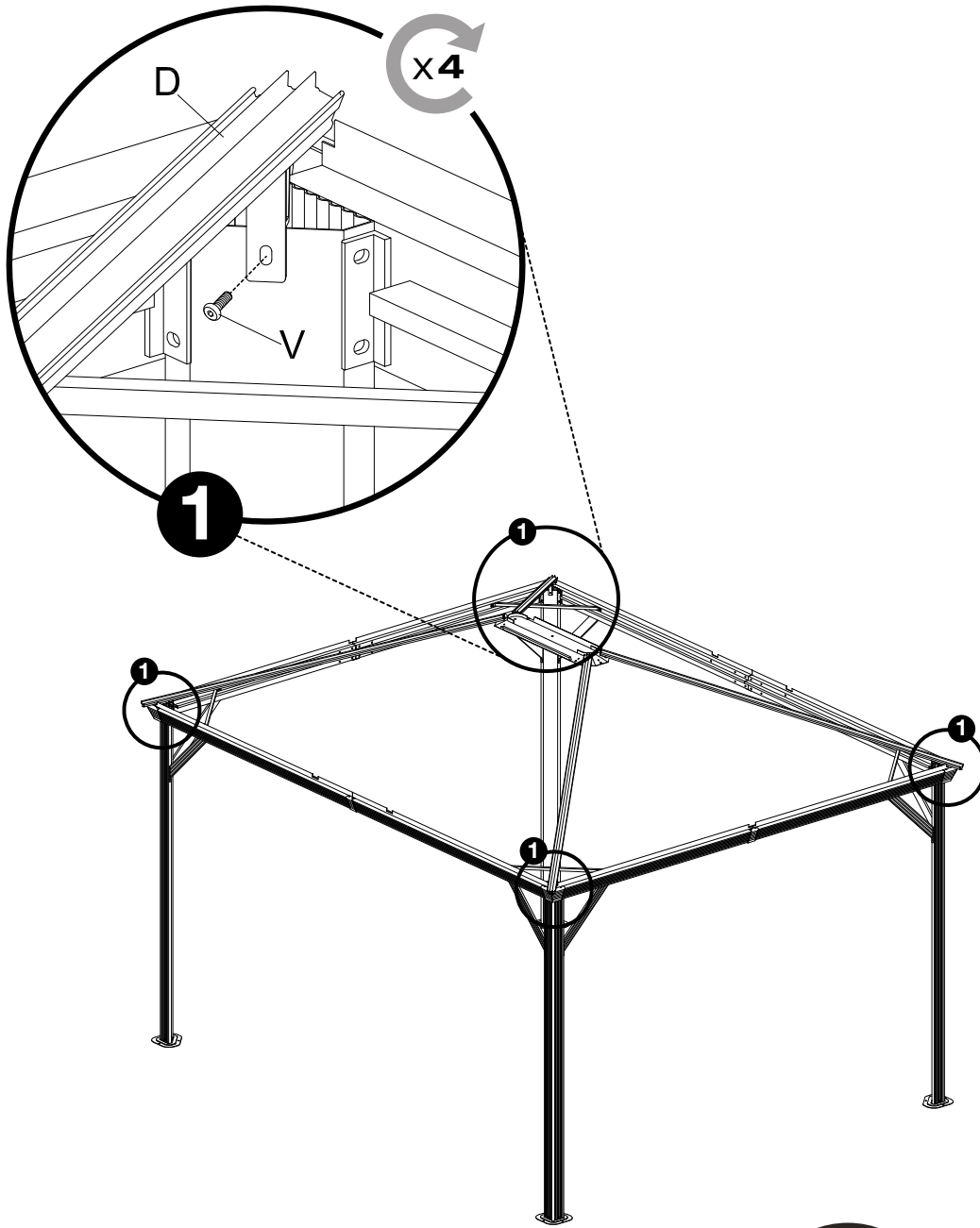

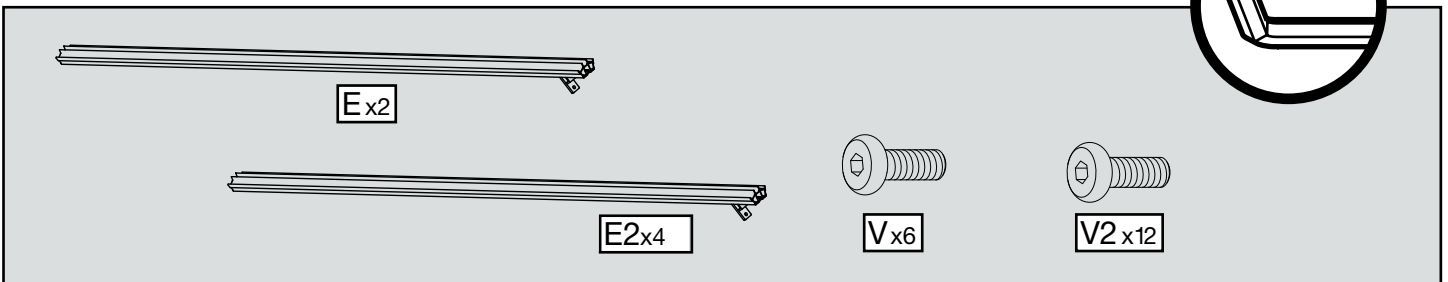
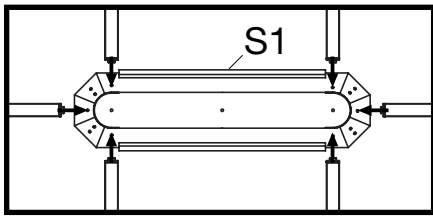
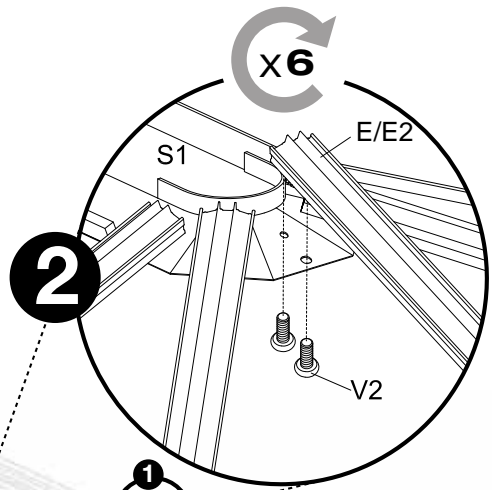
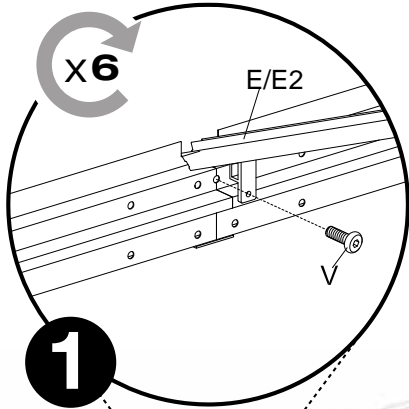
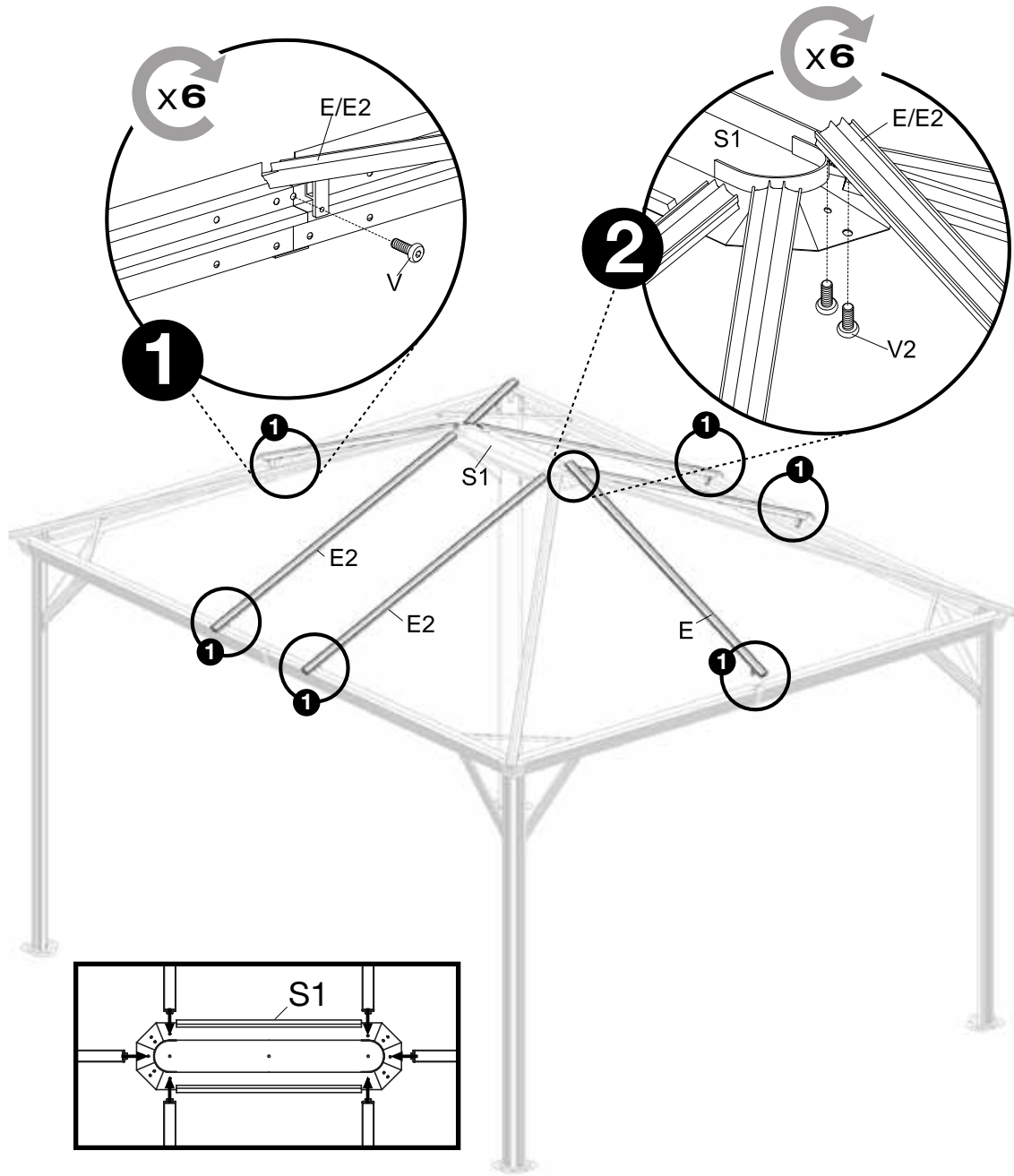

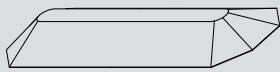
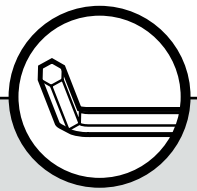
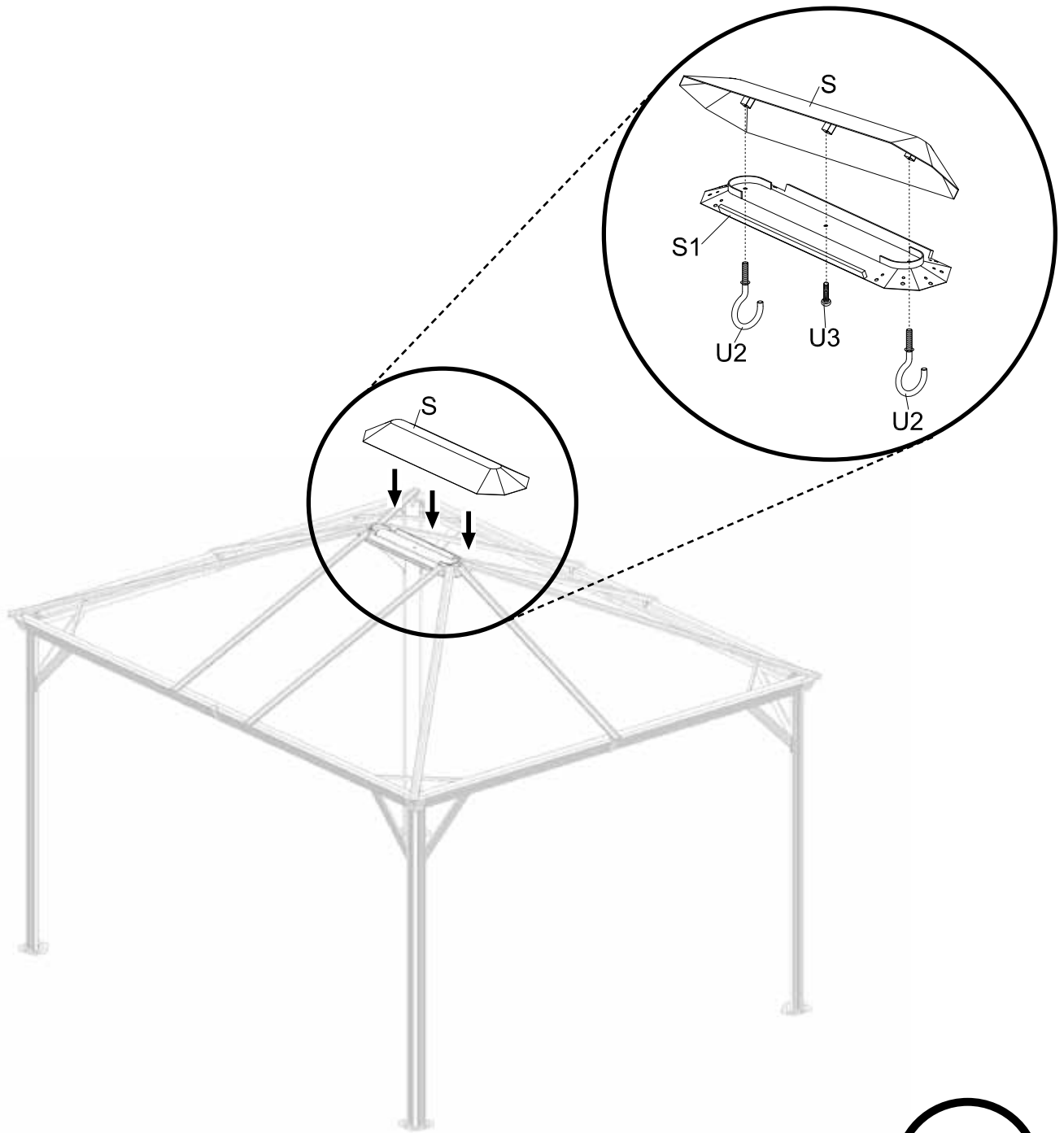

Sx1



U2x2

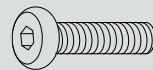

U3x1

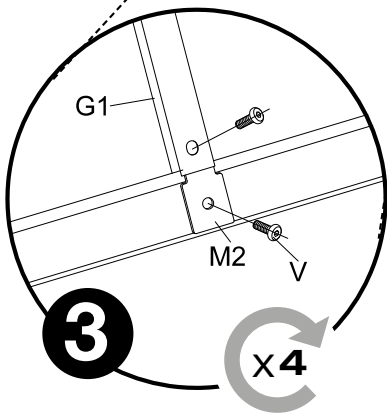
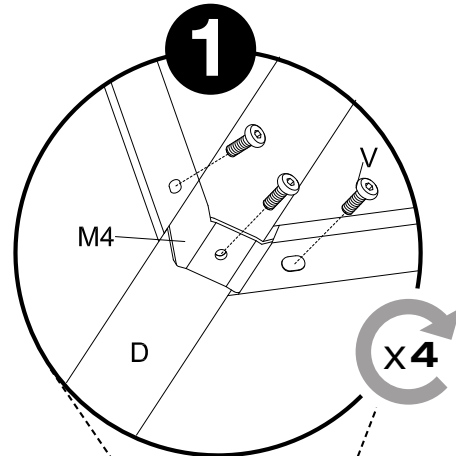
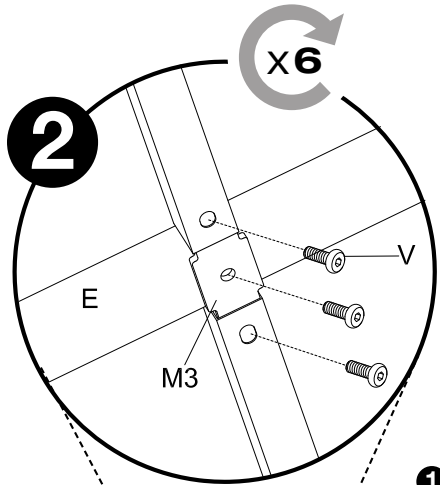
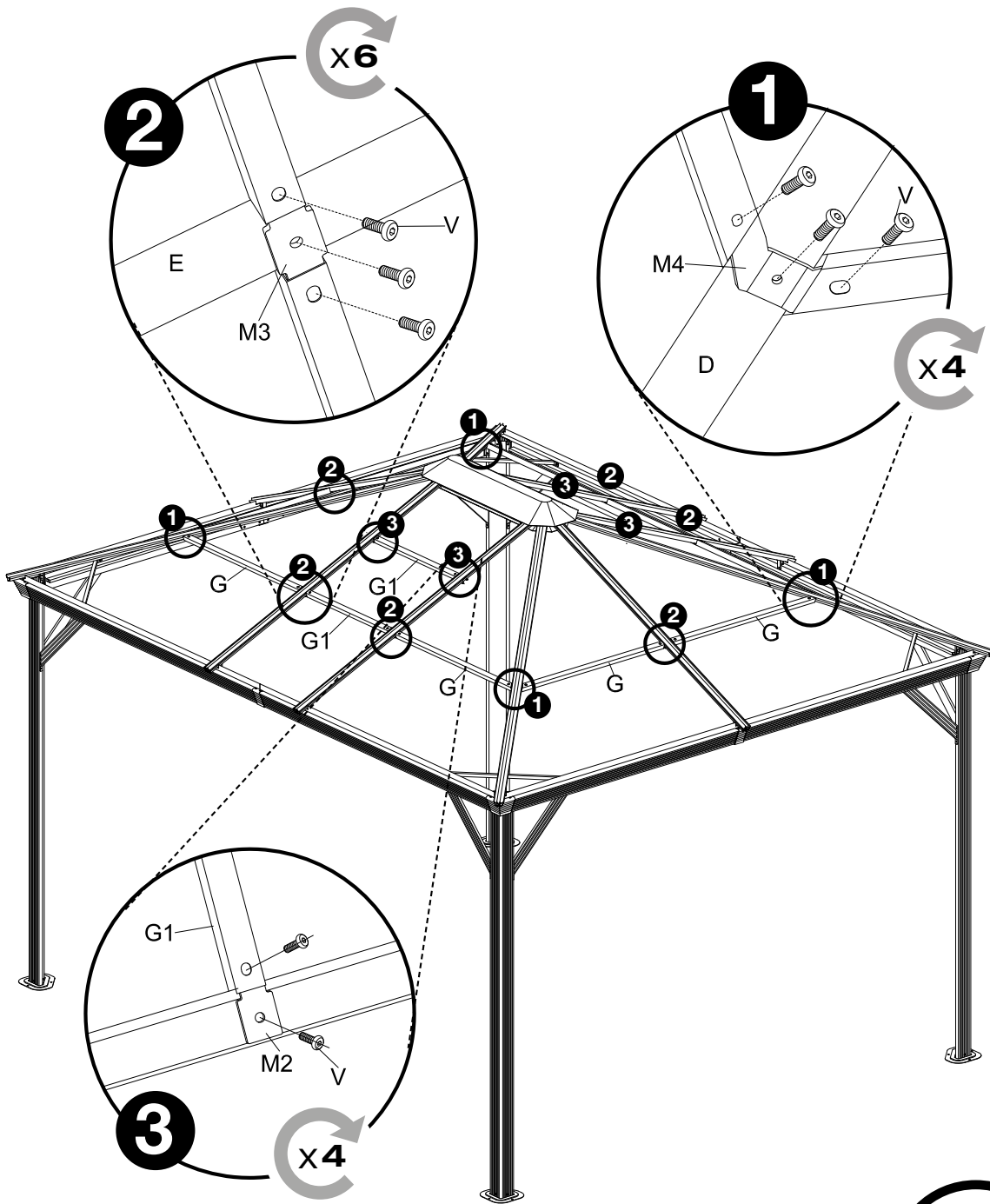

The parts list diagram shows the following components:

- Two long horizontal beams labeled **Gx8** and **G1x4**.
- A rectangular plate with two holes labeled **M2x4**.
- A rectangular plate with two holes labeled **M3x6**.
- A rectangular plate with two holes labeled **M4x4**.
- A screw labeled **Vx38**.
- A circular inset showing a corner joint with a beam and a post.

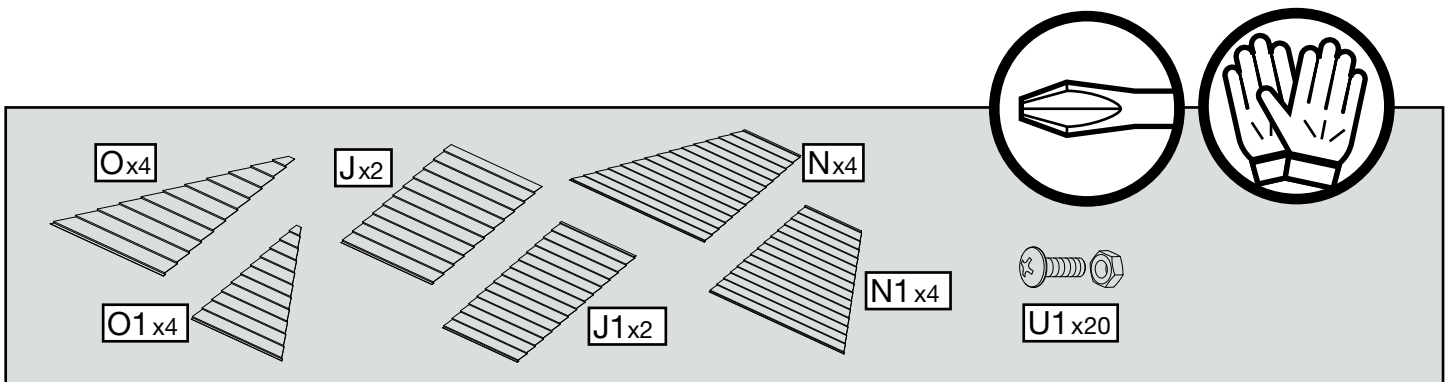
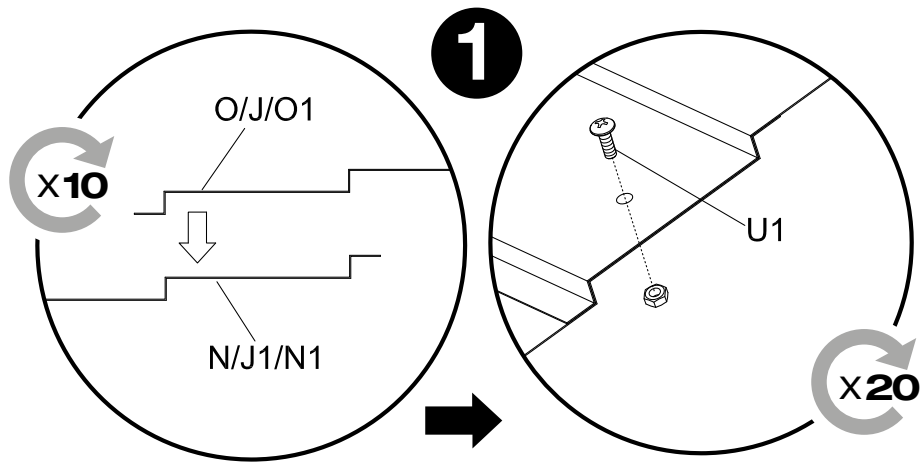
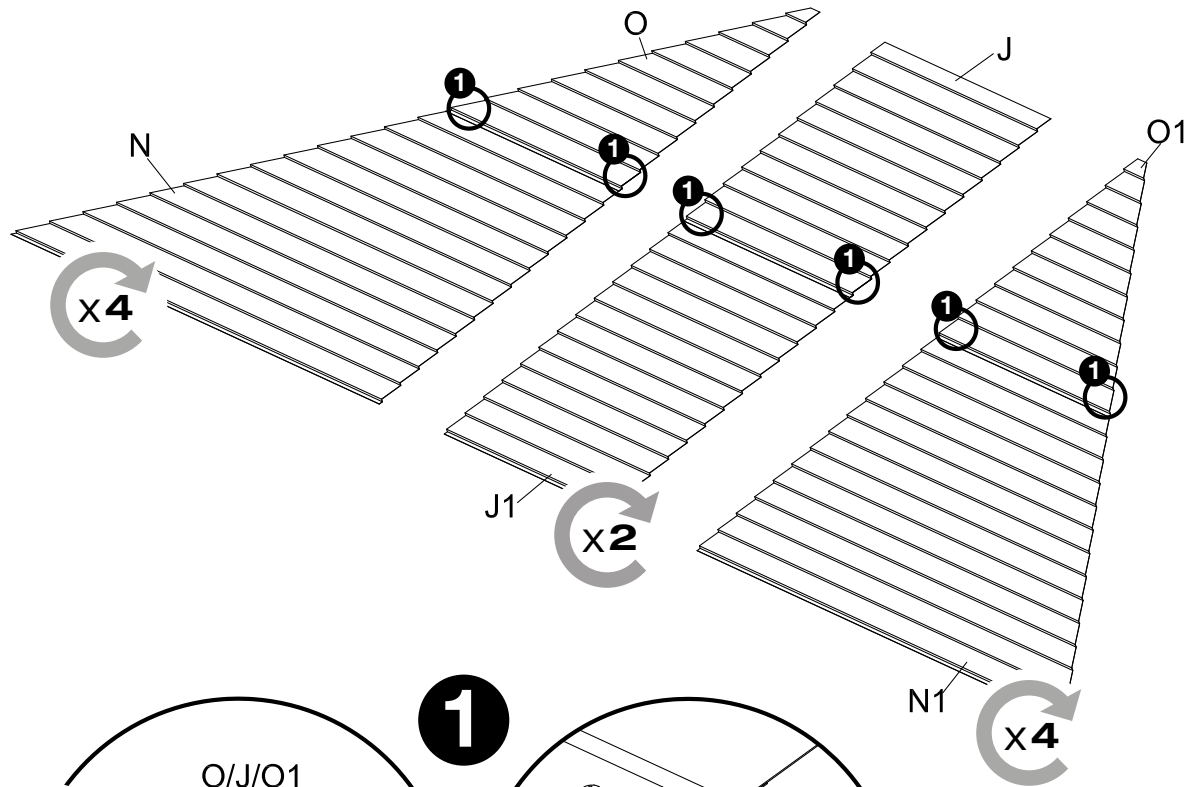

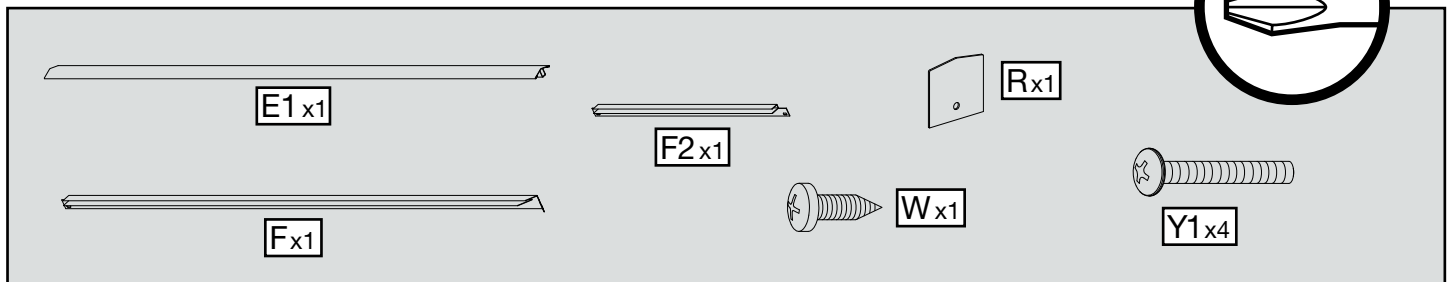
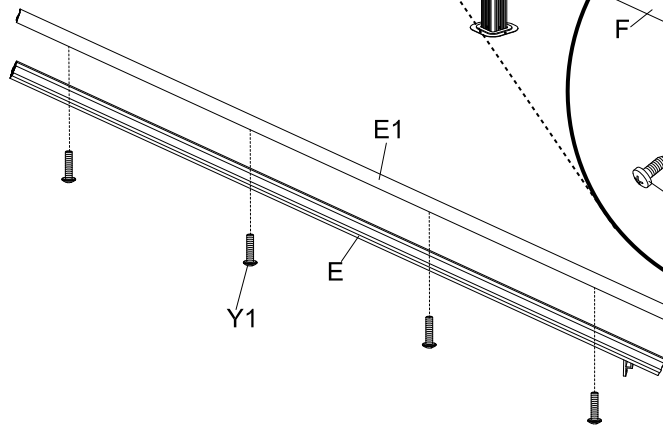
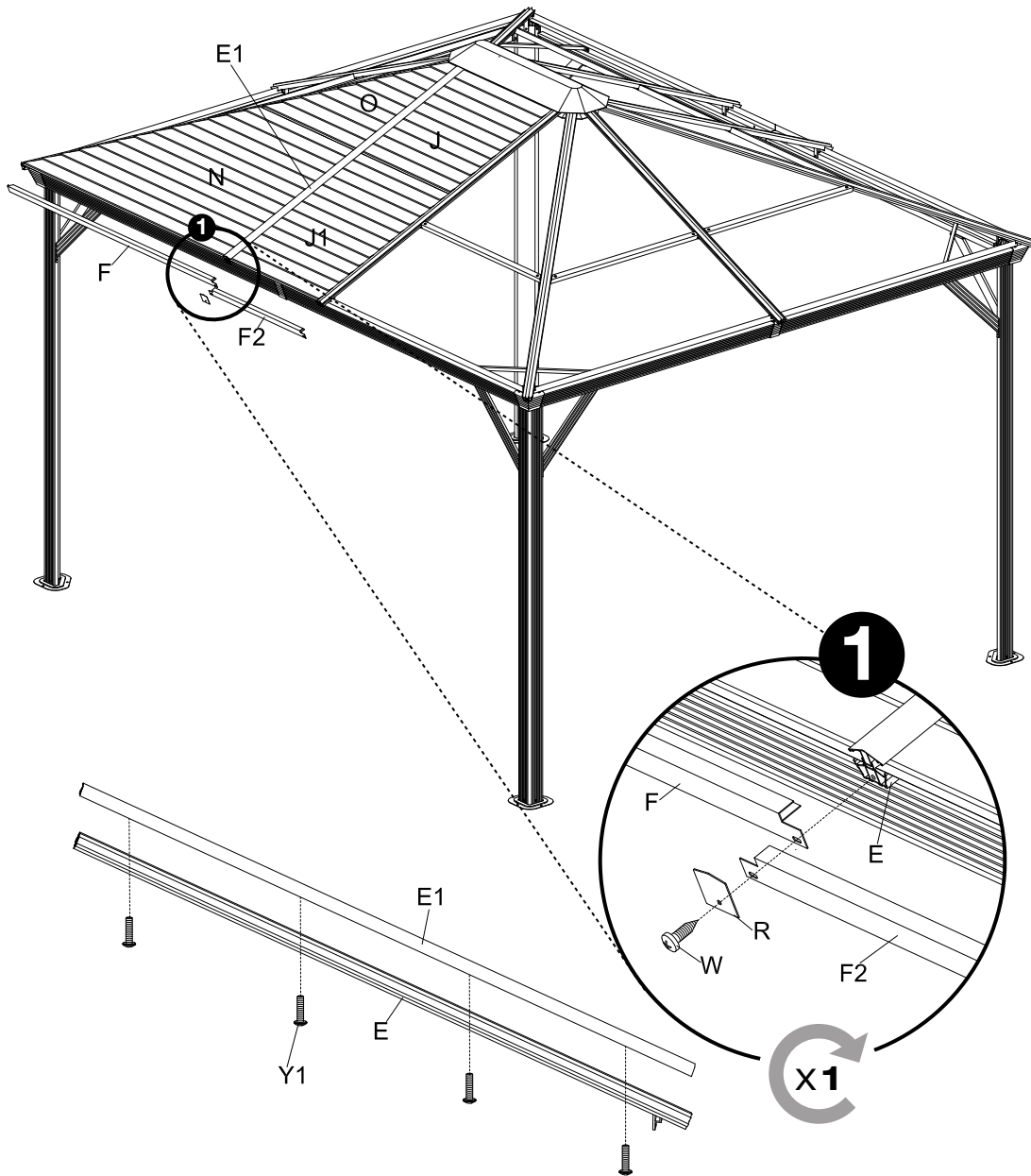

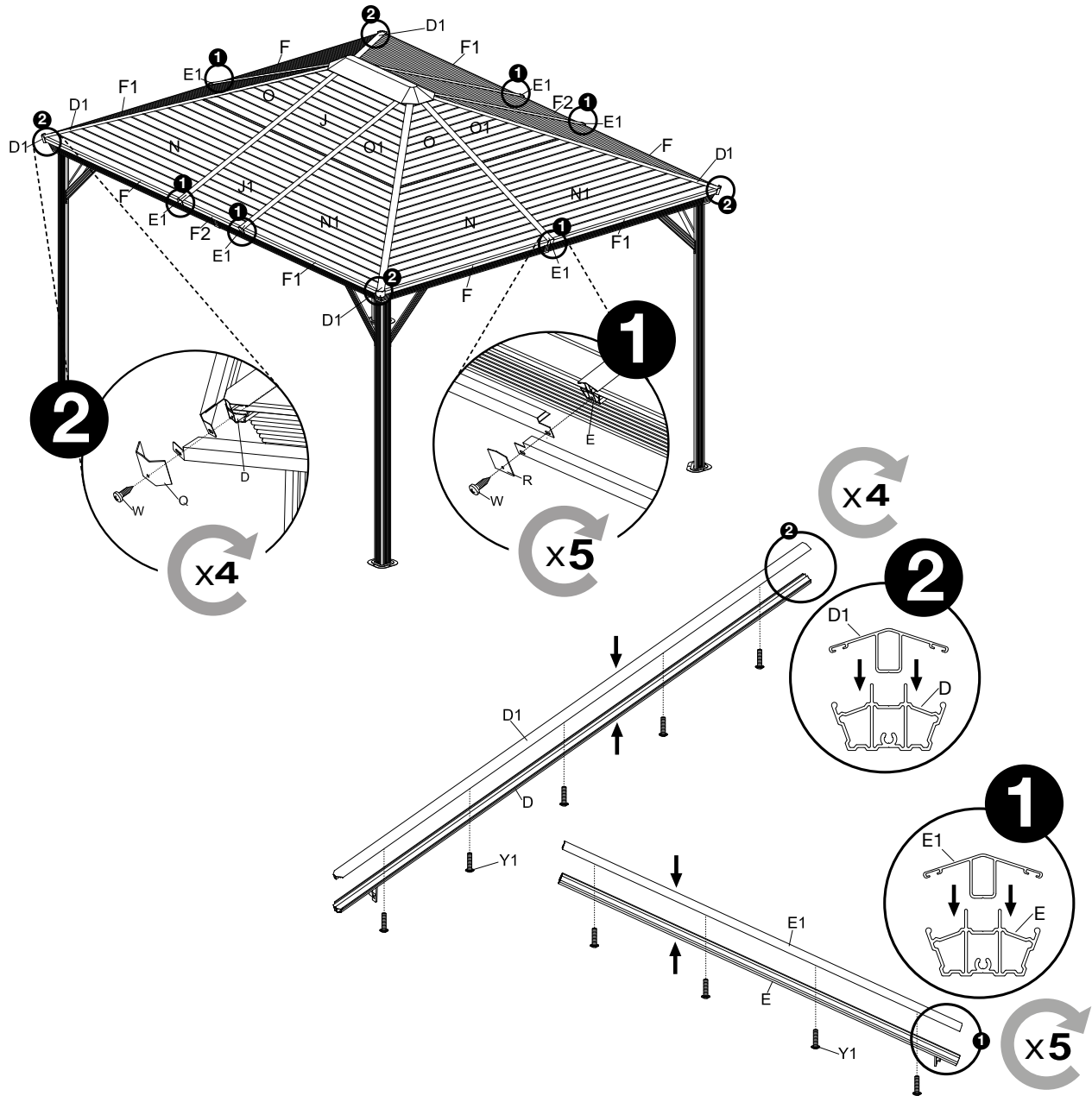

- | | | |
|--------------|--------------|---------------|
| | | |
| D1 x4 | F1 x4 | R x5 |
| | | |
| E1 x5 | F2 x1 | W x9 |
| | | |
| F x3 | Q x4 | Y1 x40 |

