

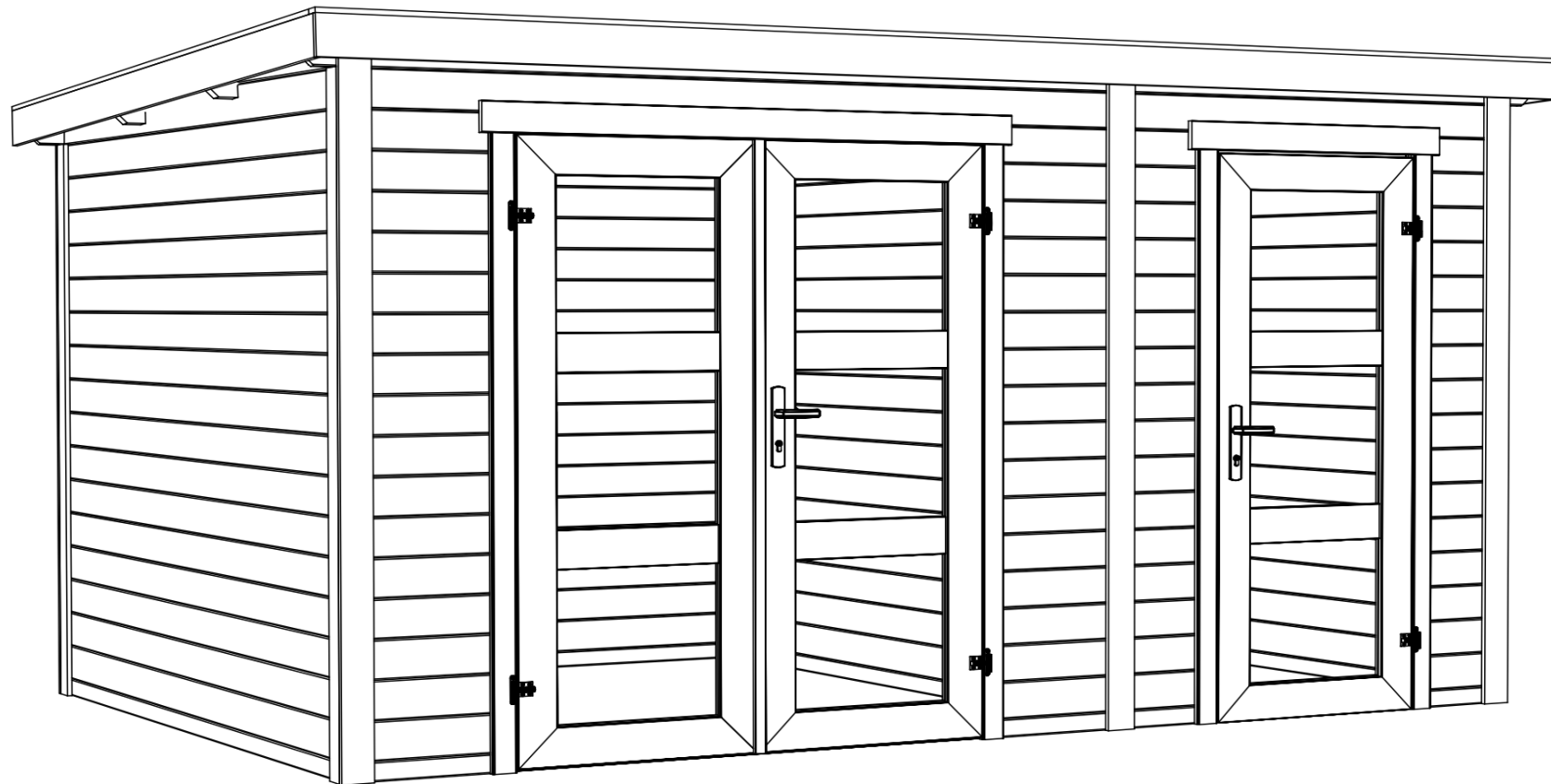

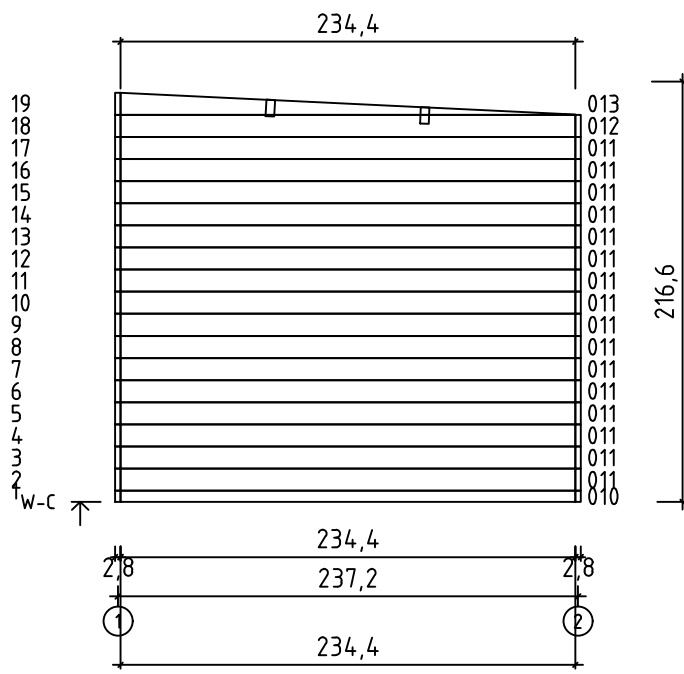

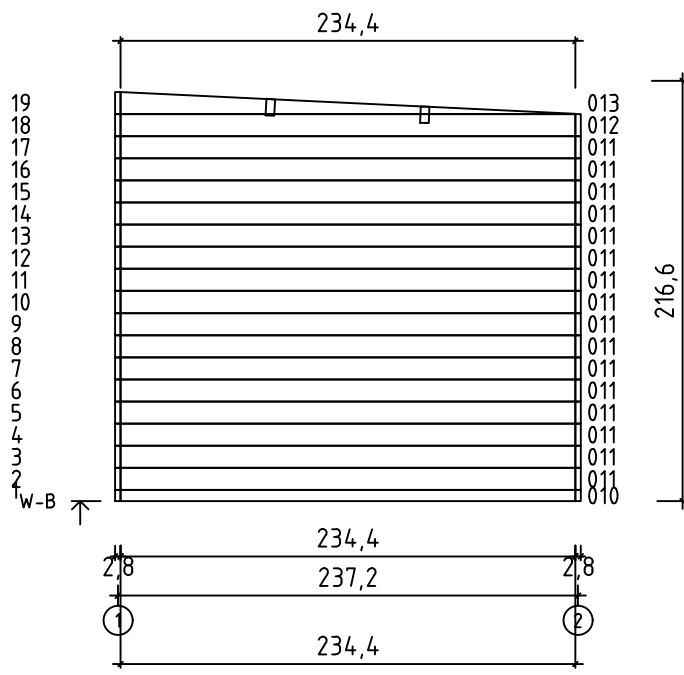

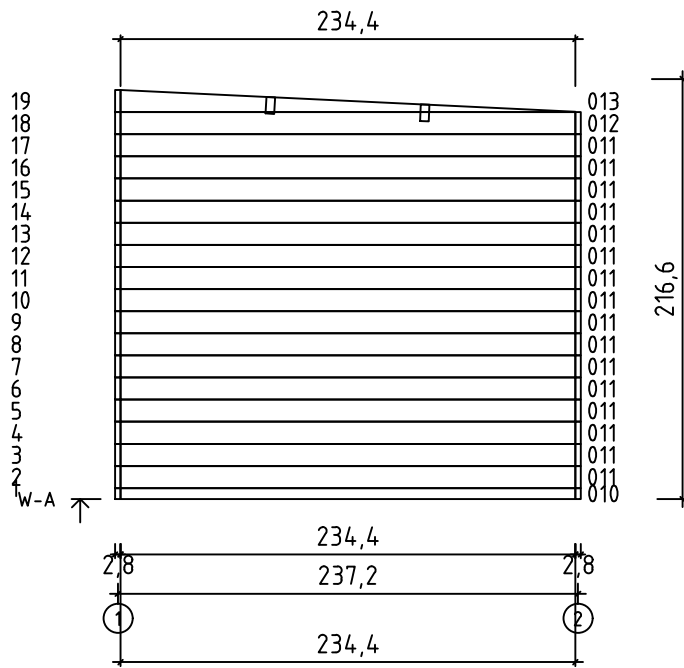



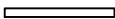









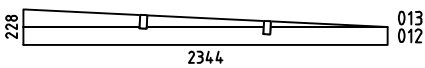
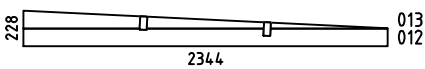
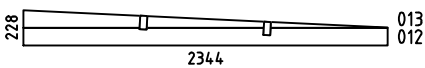
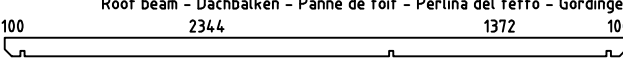
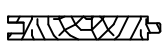



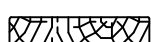
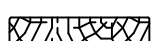



Zambezi 2-room
Art. Nr. 2851696
1/11

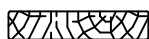
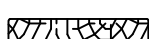

Art. Nr. 2851696

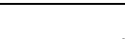
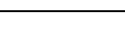
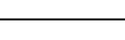
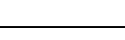

Pos	28.10.2021 Piece list - Stückliste - Liste des pièces - Elementi - Stuklijst - Tükítabel Art. Nr. 2851696 5/11	Q	P (mm)	L (mm)
001		1	28x57	430
002		1	28x57	706
003		1	28x57	304
004		16	28x114	430
005		16	28x114	706
006		16	28x114	304
007		17	28x114	3800
008		2	28x114	4000
009		1	28x57	3800
010		3	28x57	2344
011		48	28x114	2344
WA-1		1		
WB-1		1		
WC-1		1		
A-PR1	Roof beam - Dachbalken - Panne de toit - Perlina del tetto - Gordingen / dakbalk - Pärlin 	2	44x120	4000
DB	Roof boards - Dachbretter - Voliges - Perlina per tetto - Dakhout - Katuselaud 	45+1	90x15	2600
RFF1	Roofing felt fillet - Dachpappenleiste - Baguette de fixation du feutre bitumeux - Asse per fissaggio guaina bituminosa - Afdekljst asfaltpapier - Katusepapiiist 	2	15x45	2620
RFF2	Roofing felt fillet - Dachpappenleiste - Baguette de fixation du feutre bitumeux - Asse per fissaggio guaina bituminosa - Afdekljst asfaltpapier - Katusepapiiist 	1	15x45	4030
DL1	Corner fillet - Deckleiste - Profils de finition angles a l'exterieur - Massello d'angolo - (hoek)lijst - Nurgaliist 	2	15x70	1881
DL2	Corner fillet - Deckleiste - Profils de finition angles a l'exterieur - Massello d'angolo - (hoek)lijst - Nurgaliist 	2	15x70	1995
DL3	Corner fillet - Deckleiste - Profils de finition angles a l'exterieur - Massello d'angolo - (hoek)lijst - Nurgaliist 	3	15x90	1995
DL4	Corner fillet - Deckleiste - Profils de finition angles a l'exterieur - Massello d'angolo - (hoek)lijst - Nurgaliist 	3	15x90	2100
P1	Post - Pfosten - Poteau - Piede registrabile - Stijl - Post 	4	44x44	1970

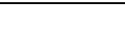
Pos	28.10.2021 Piece list - Stückliste - Liste des pièces - Elementi - Stuklijst - Tükítabel Art. Nr. 2851696 6/11	Q	P (mm)	L (mm)
P2	Post - Pfosten - Poteau - Piede registrabile - Stijl - Post 	4	44x44	2100
TB1	Fascia board - Traufbrett - Bandeau de toit - Finitura lati tetto - Gevellijst - Räästalaud 	1	15x45	4000
DRV1	Roof edge reinforcement - Dachrandverstärkung - Corniere de renfort de bord de toit - Rinforzo x tetto - Dakrand versterking - Räästatugevdus 	1	28x34	4000
FF	Fixing fillet - Fixierungsleiste - Profil de fixation - Massello di fissaggio - Bevestiging lijstwerk - Tenderliist 	4	18x28	1850
GL1	Gable moulding - Giebelleiste - Planche de rive - Finitura per frontale e retro del tetto - Gevellijst - Viilulaud 	2	15x120	2650
GL2	Gable moulding - Giebelleiste - Planche de rive - Finitura per frontale e retro del tetto - Gevellijst - Viilulaud 	1	15x120	4030
HS4	Screw for corner fillet - Schraube zur befestigung deckleiste - Vis pour profils de finition angles a l'exterieur - Viti per massellino d'angolo - Schroef voor afdekljst (hoek) - Kruvi nurgaliistule 	80	3x30	
HS4	Screw for fascia boards - Schrauben für traufbretter - Vis pour fixation bandeau de toit - Viti x striscia del tetto - Schroef voor gevellijst - Kruvi räästalauale 	8	3x30	
HS12	Screw for roof edge reinforcement - Schrauben für dachrandverstärkung - Vis pour fixation corniere renfort de bord de toit - Viti x rinforzo bordo tetto - Schroef voor dakrand versterking - Kruvi räästatugevdusele 	8	4x40	
HS12	Screw for fixing fillet of door and window - Schrauben für fixierungsleiste - Vis pour profil vertical de fixation pour ouvertures des fenetres et portes - Viti per massello di fissaggio - Schroeven voor bevestiging van deur en raam lijsten - Kruvi tenderliistufudele 	68	4x40	
HS12	Screw for gable moulding - Schrauben für giebelleiste - Vis pour fixation planche de rive - Vite per fissare finiture davanti e dietro del tetto - Schroef voor gevellijst - Kruvi viilulauale 	24	4x40	
HS13	Screw for wall mounting - Schrauben für wandmontage - Vis de fixation au mur - Viti per montaggio a parete - Schroef voor wandmontage - Kruvi seinte montaažiks 	580	4x60	
HS18	Screw for roof beams - Schrauben für dachbalken - Vis pour fixation pannes de toit - Viti per perline del tetto - Schroef voor gordingen / dakbalken - Kruvi pärlinitele 	6	5x120	
HS18	Screw for gable - Schrauben für giebel - Vis pour fixation des pignons - Viti per timpano - Schroef voor gevelpunt - Kruvi viilude kinnitamiseks 	6	5x120	
SH28	Hammer block - Schlagholz - Calle de frappe - Blocco di legno da usare come cuscinetto quando si usa il martello - Slagklos - Löögiklots 	1		
NF4	Zn nail for roof - Zn nägel für dachbretter - Pointe pour fixation voliges de toit - Chiodi x perline tetto - Spijker(nagel) voor dakhout - Nael katuselauale 	188	2x50	
NF5	Zn nail for roofing felt fillet - Zn nägel für dachpappenleiste - Pointe pour baguette de fixation feutre bitumeux - Chiodi x carta bituminosa x tetto - Spijker(nagel) voor asfaltpapier afdekljst - Papiliistunael 	20	2x40	
	Door - Tür - Porte - Porte - Deur - Uks 1494x1850 TUK.3.030.XVP.MX28 XGA+28	1		
	Door - Tür - Porte - Porte - Deur - Uks 775x1850 UK.3.030.XVP.MX28 XGA+28	1		

Art. Nr. 2851696

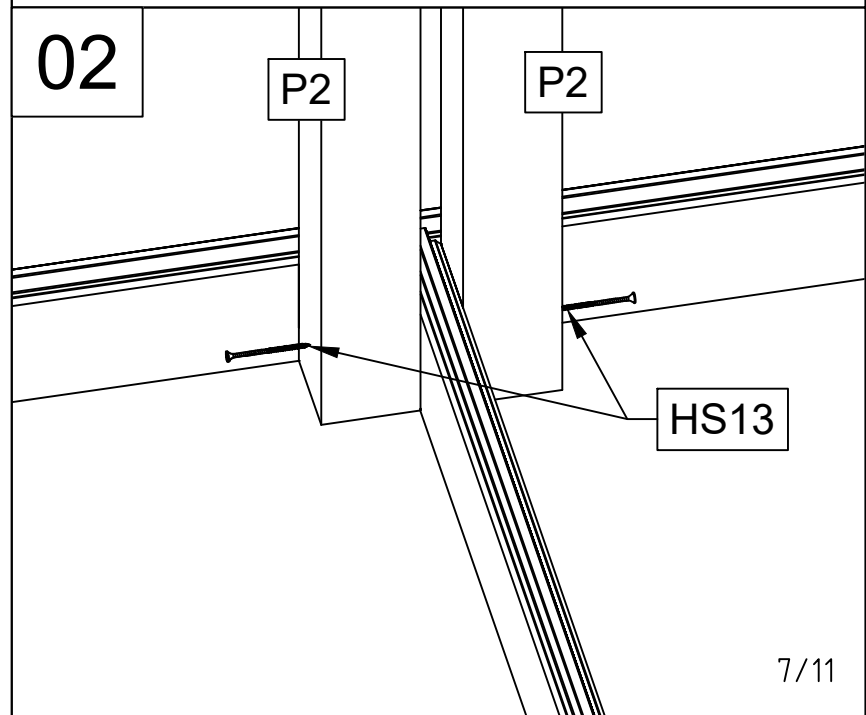
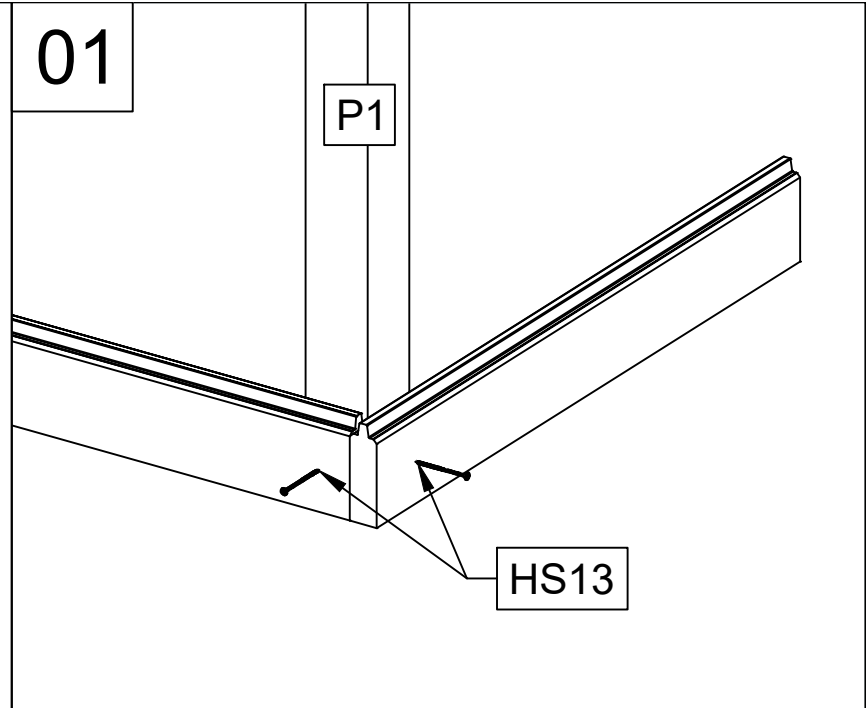
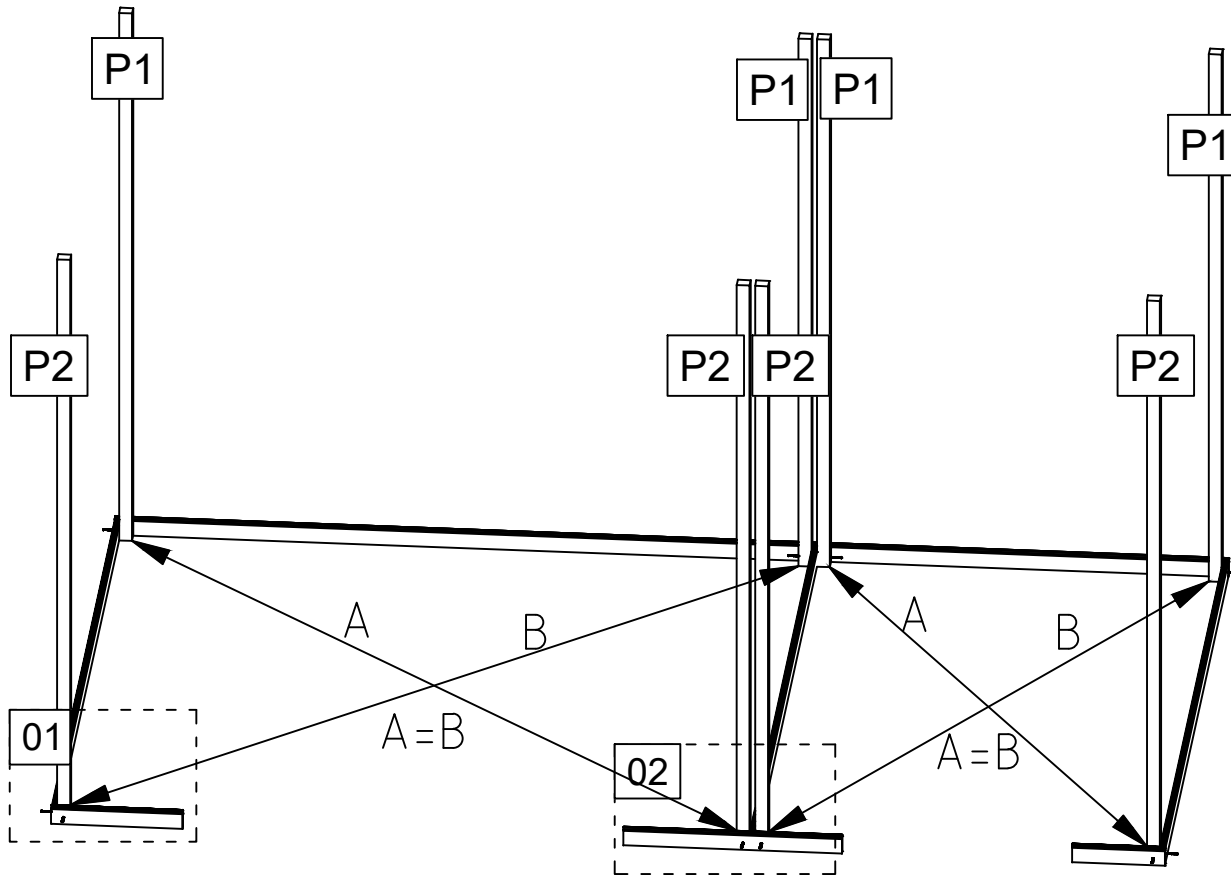

Art. Nr. 2851696

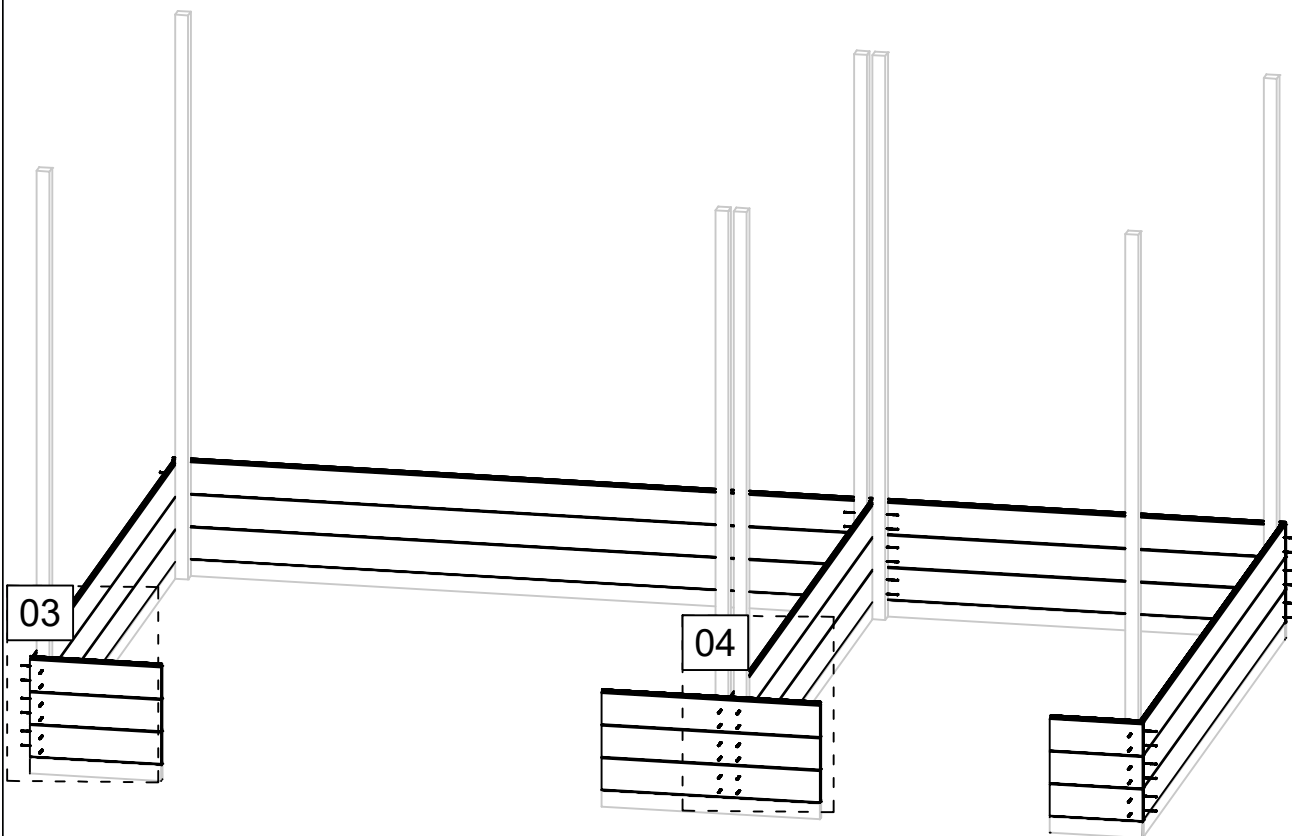

03

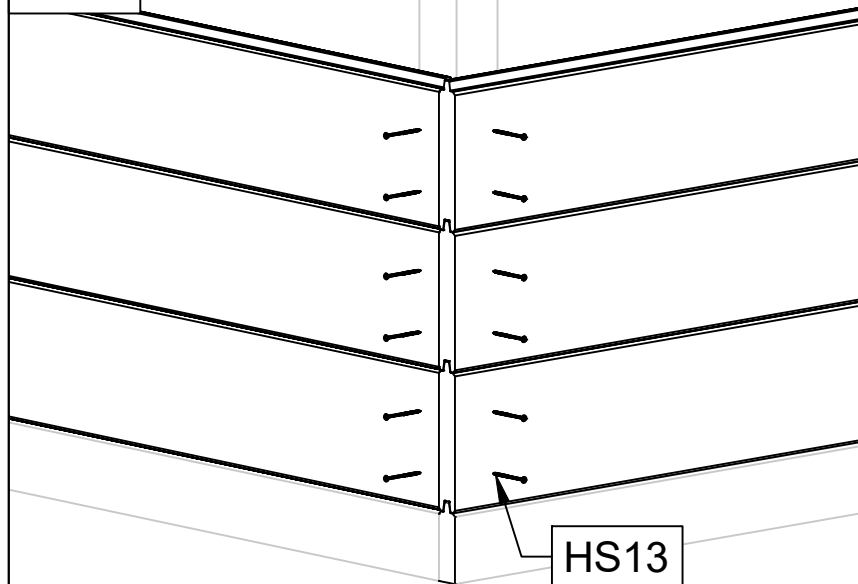

04

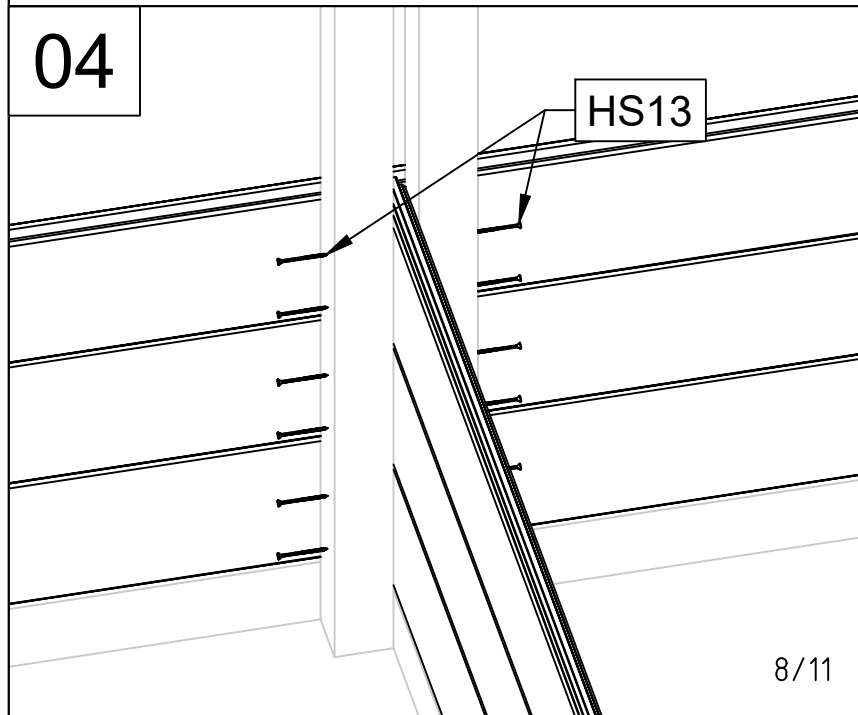

Art. Nr. 2851696

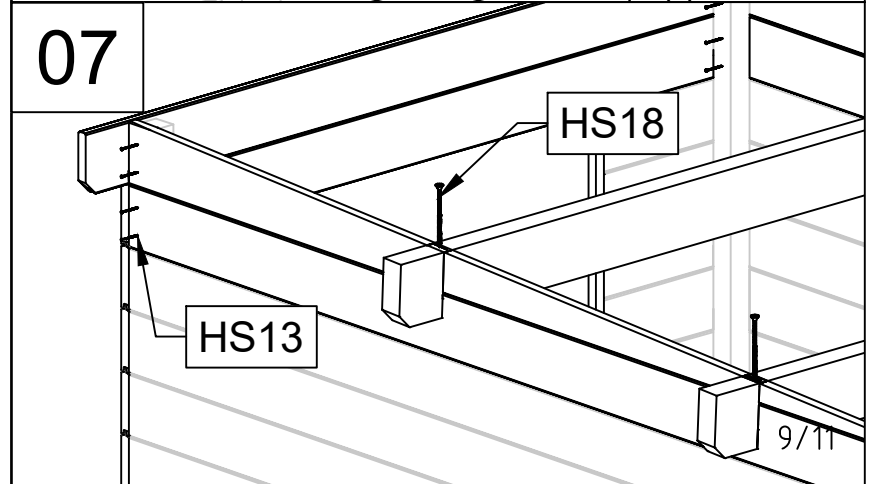
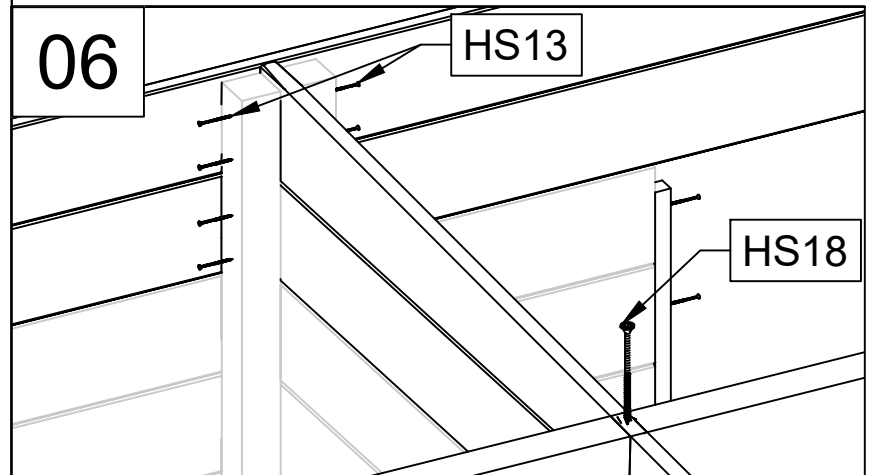
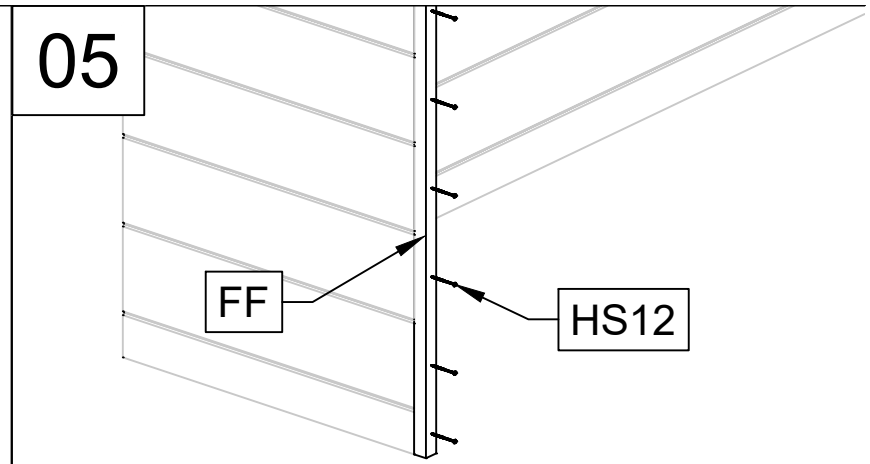
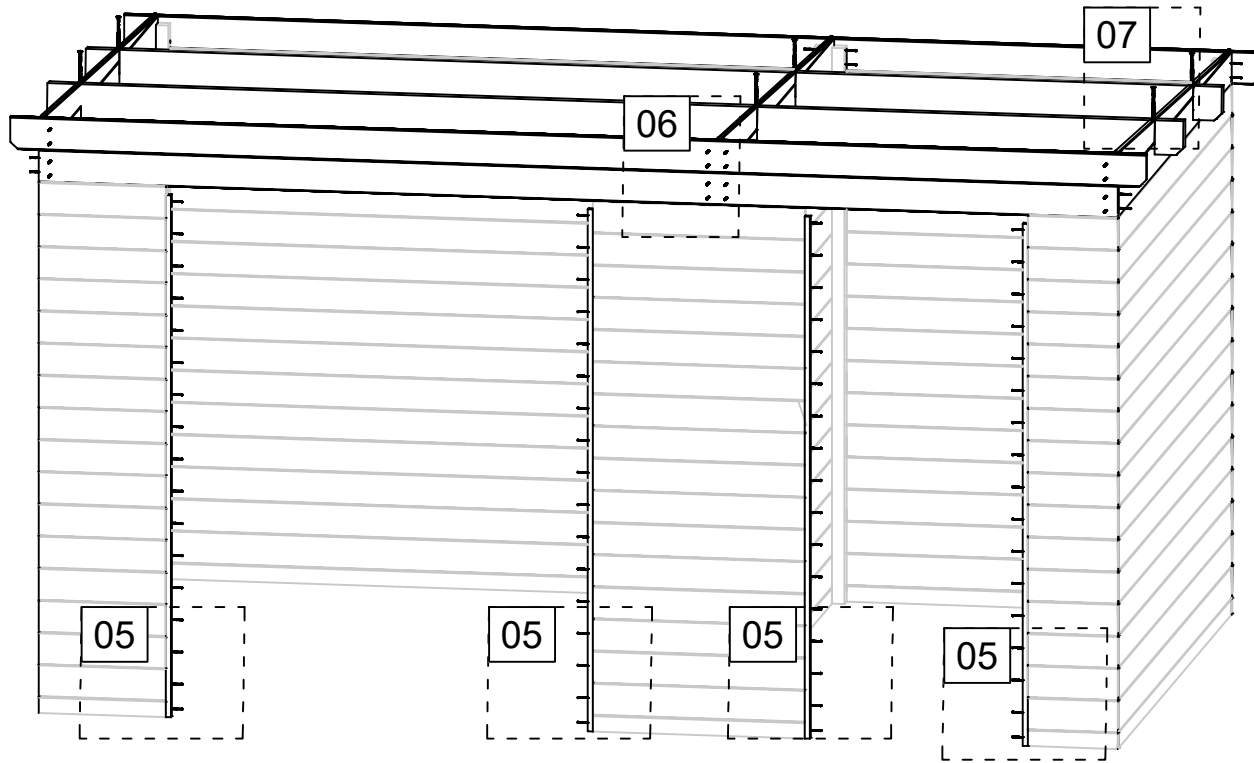



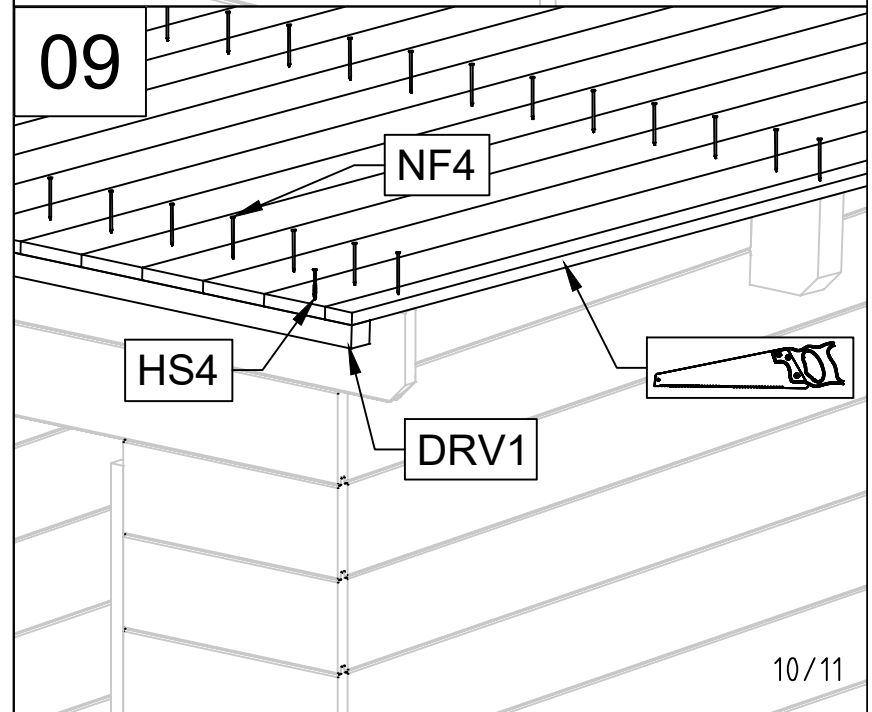
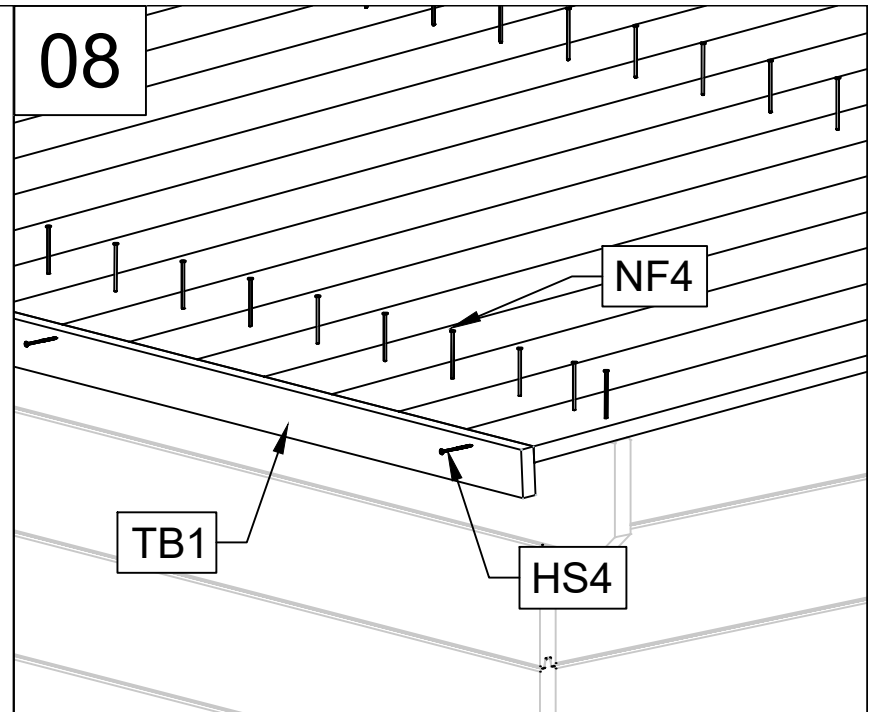
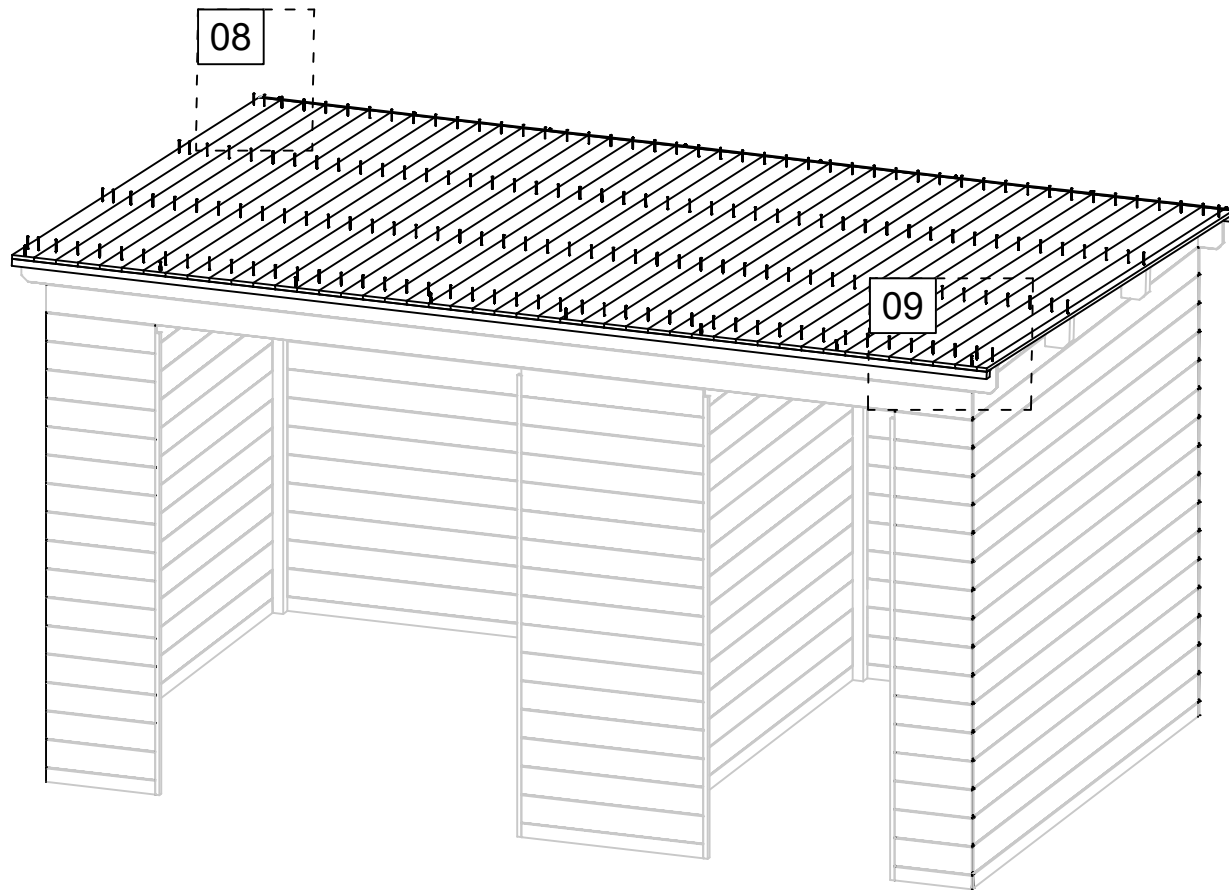



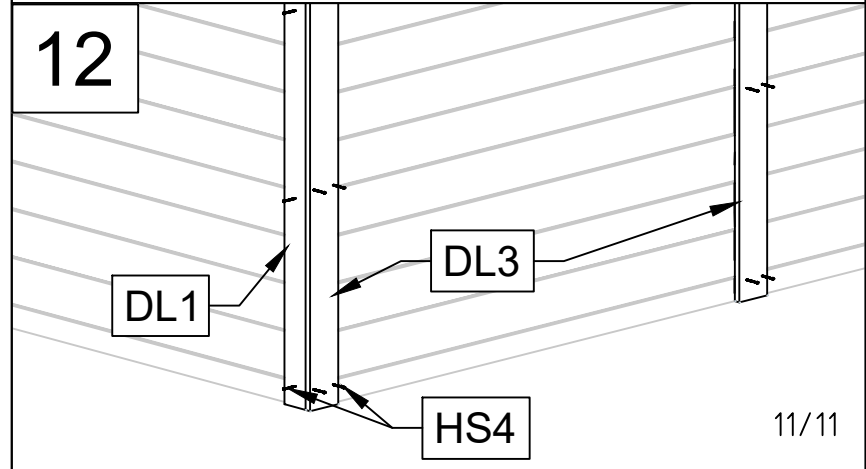
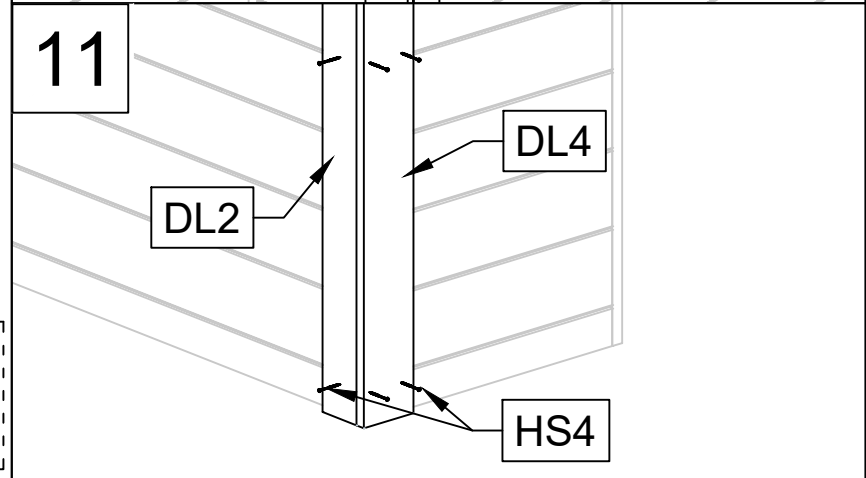
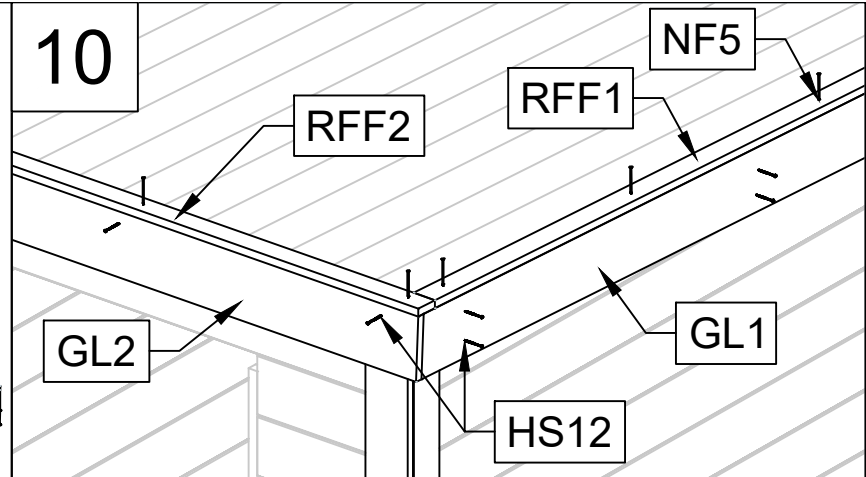
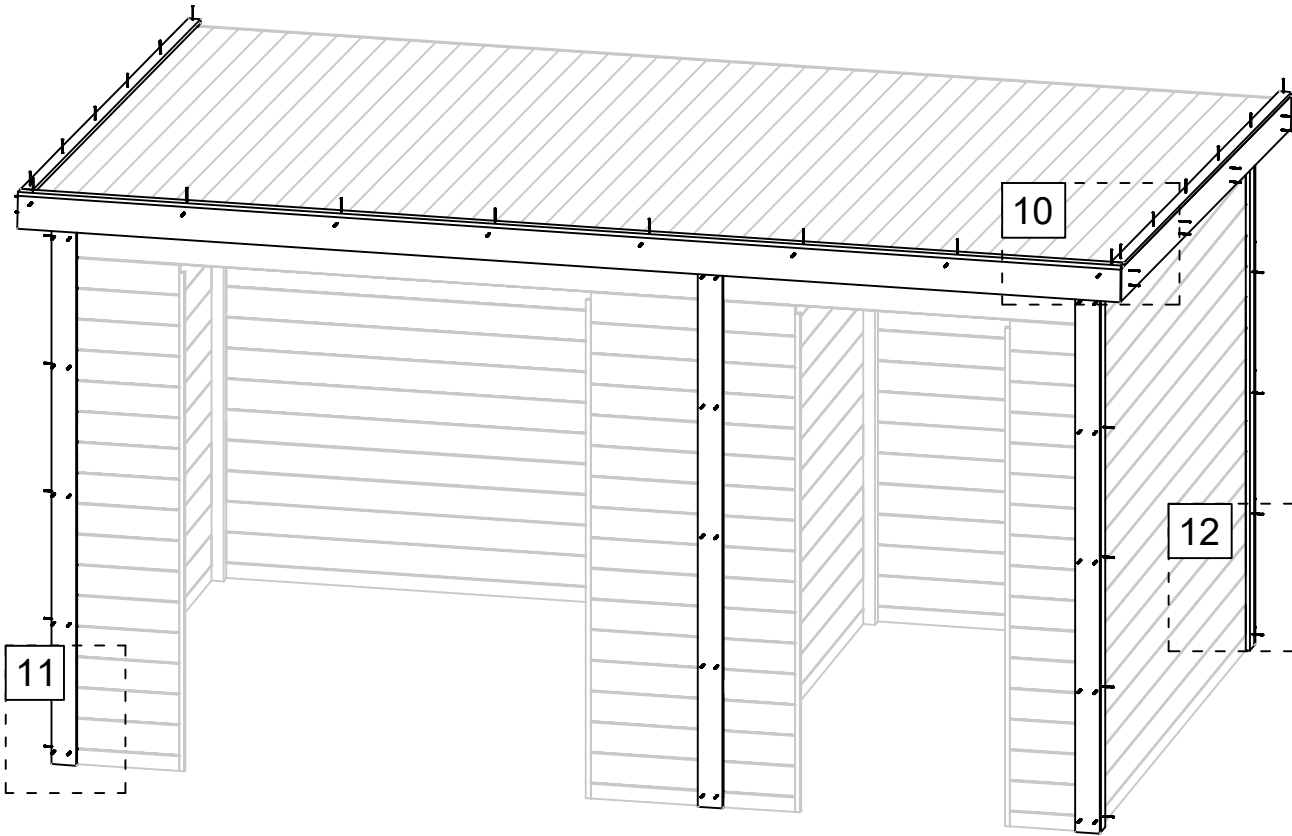

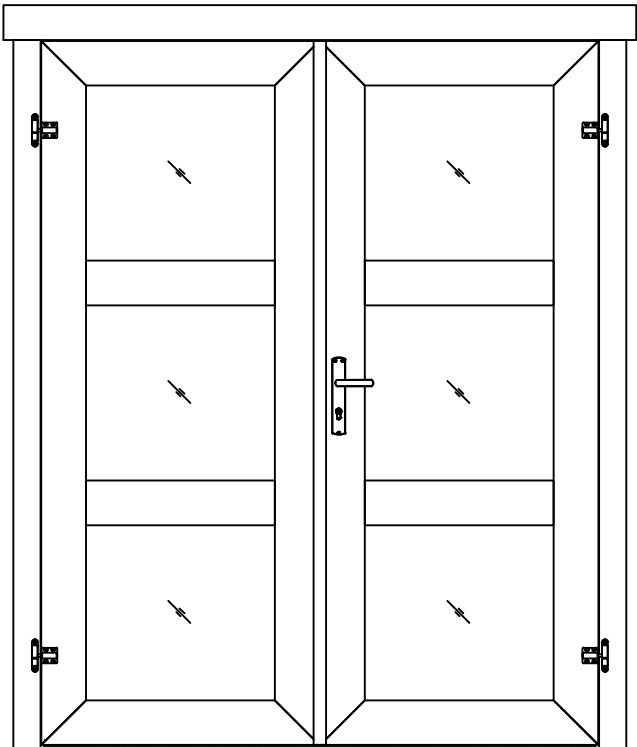
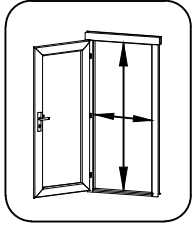

Art. Nr. 2851696



Art. Nr. 2851696

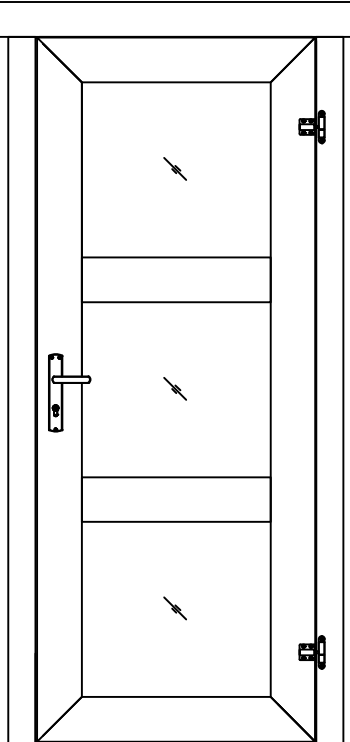
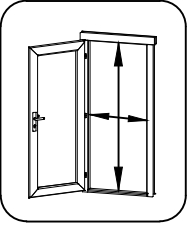

Pos	12.10.2021	Piece list - Stückliste - Liste des pièces - Elementi - Stuklijst - Tükítabel 14.94x1850 TUK.3.030.XVP.MX28 XGA+28	1/2	Q	P (mm)	L (mm)
		  <p>1418x1794 mm</p>				
1	Upper door jamb - Türrahmen oben - Cadre de porte supérieur - Telaio superiore della porta - Bovendorpel - Ukse ülemine leng		1	66x100	1628	
2	Left door jamb - Türrahmen links - Cadre de porte gauche - Telaio montante sinistro della porta - Linkerstijl deurframe - Ukse vasak leng		1	66x80	1850	
3	Right door jamb - Türrahmen rechts - Cadre de porte droit - Telaio montante destro della porta - Rechterstijl deurframe - Ukse parem leng		1	66x80	1850	
4	Doorstep - Swelle - Barre de seuil - Soglia della porta - Deurdorpel - Lävepakk		1	18x18	1418	
5	Connection strip - Deckleiste - Baguette de battement - Profilo verticale della porta - Stulplijst - kokkuvaltšiliist		1	13x32	1812	

Pos	12.10.2021 Piece list - Stückliste - Liste des pièces - Elementi - Stuklijst - Tükítabel 775x1850 UK.3.030.XVP.MX28 XGA+28	1/2	Q	P (mm)	L (mm)
	  <p data-bbox="1369 398 1497 430">702x1793 mm</p>				
1	Upper door jamb - Türrahmen oben - Cadre de porte supérieur - Telaio superiore della porta - Bovendorpel - Ukse ülemine leng		1	66x100	722
2	Left door jamb - Türrahmen links - Cadre de porte gauche - Telaio montante sinistro della porta - Linkerstijl deurframe - Ukse vasak leng		1	66x80	1850
3	Right door jamb - Türrahmen rechts - Cadre de porte droit - Telaio montante destro della porta - Rechterstijl deurframe - Ukse parem leng		1	66x80	1850
4	Doorstep - Swelle - Barre de seuil - Soglia della porta - Deurdorpel - Lävepak		1	18x18	702

