

(D) Montageanleitung

(FR) Notice de montage

(NL) Handleiding voor de montage

(CZ) Montážní návod

(HU) Szerelési útmutató

(TR) Montaj talimatı

(GB) Assembly Instructions

(IT) Istruzioni di montaggio

(PL) Instrukcjã montażu

(SK) Návod na montáž

(RO) Instrucțiuni de montaj

(RU) инструкция по монтажу

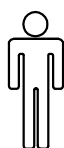

30min

Service • Assistenza • Dienstverlening • Serwis
 Servis • Szerviz • Сервисная • служба

Name • Nom • Nome • Naam • Nazwa • Jméno
 Názov • Név • Denumire • Isim • Название

Nr. • No. • N° • Номер • Č • Sz

Typ • Type • Tip • Típus • Tipo • Тип

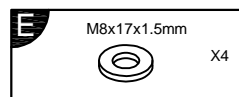
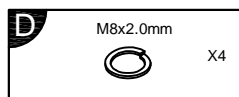
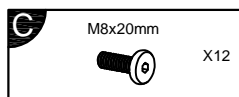
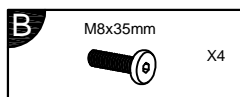
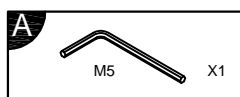
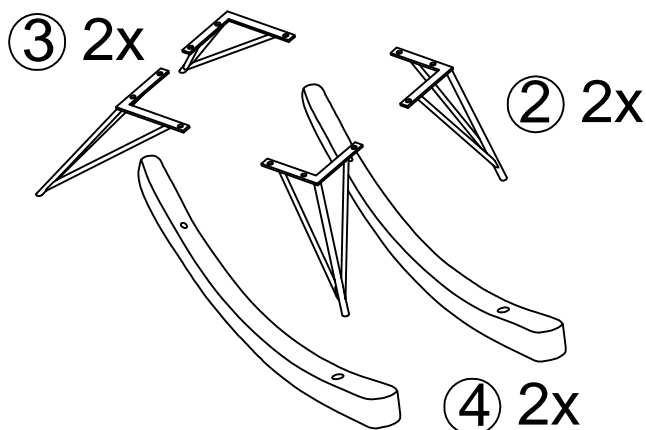
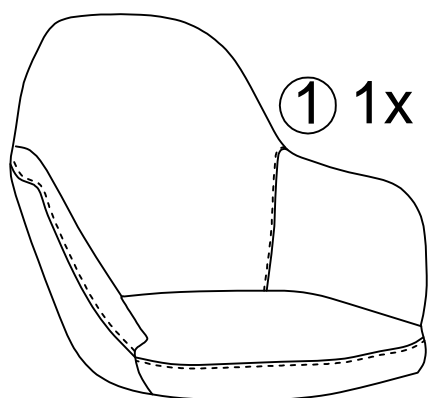
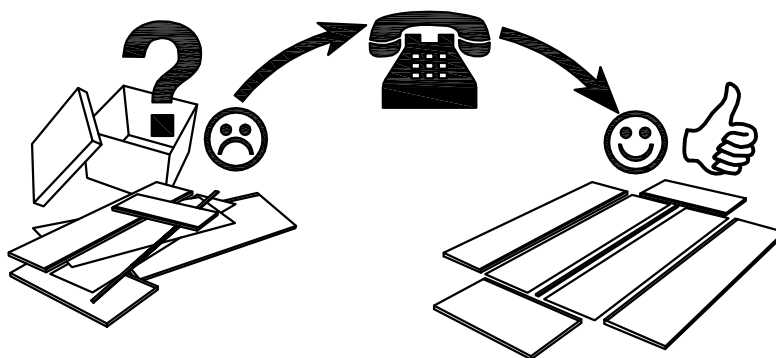
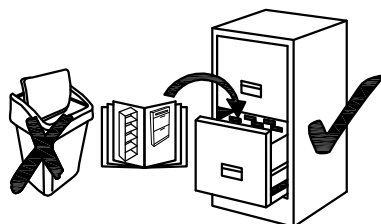

1

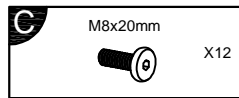
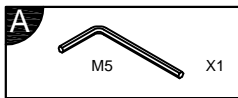
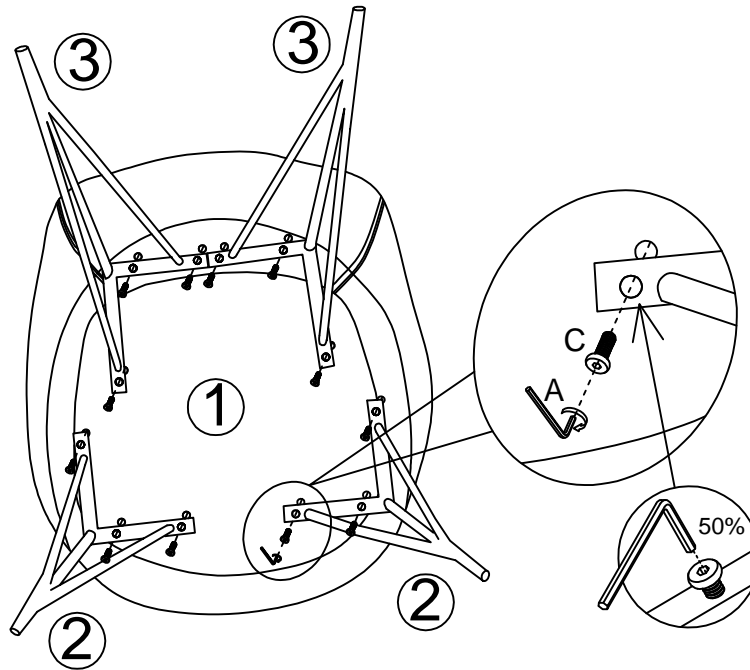

2

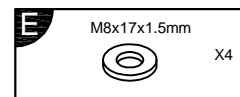
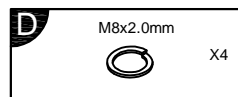
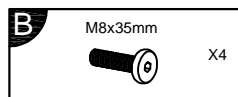
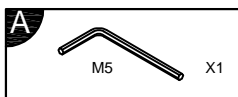
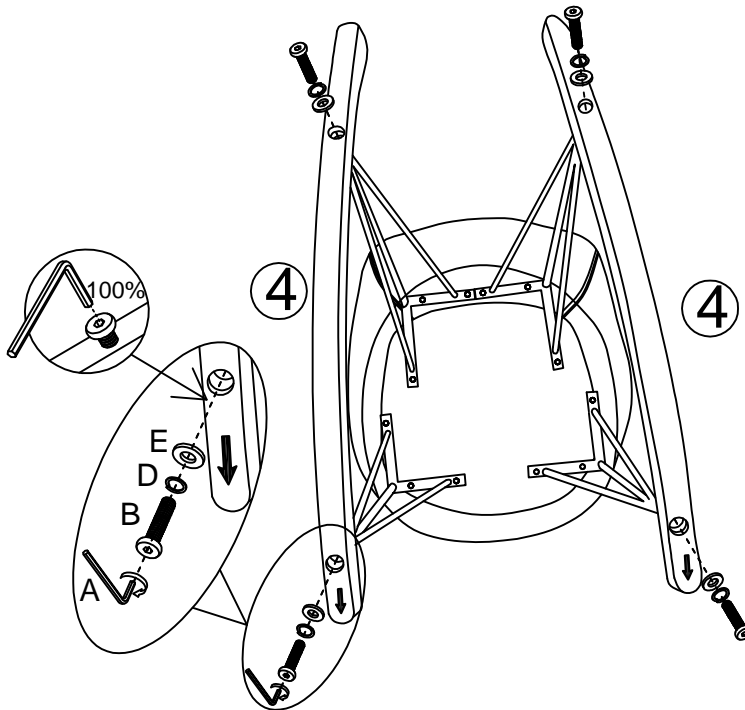

3

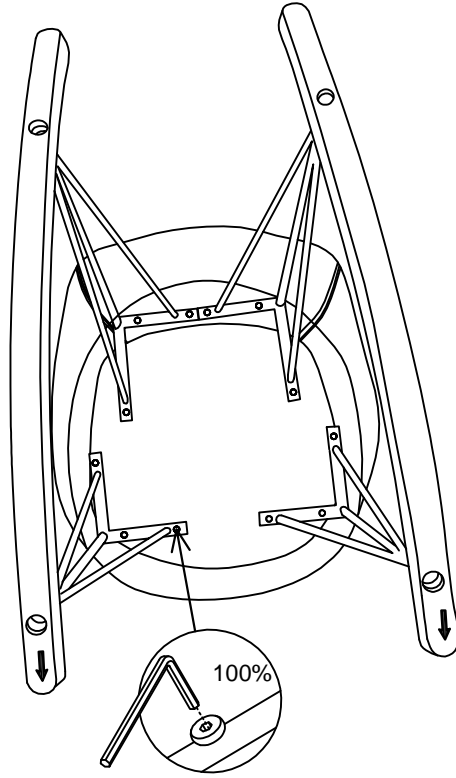

4

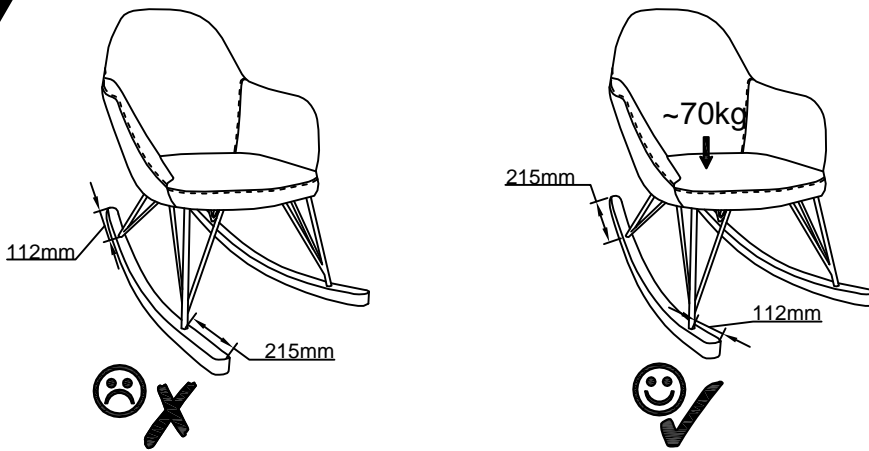

5

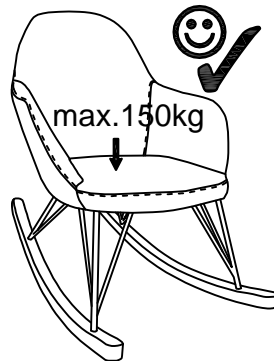

1	D	Ziehen Sie alle Schrauben sowie tragende Verbindungsteile nach ca. 5 Wochen nach, um eine dauerhafte Standsicherheit zu gewährleisten.	
	GB	After approx. 5 weeks, tighten all screws and load-bearing connecting parts to ensure permanent stability.	
	FR	Resserrez toutes les vis ainsi que les pièces de fixation au bout d'environ 5 semaines pour garantir une sécurité de fixation durable.	
	IT	Ristringere tutte le viti e giunture dopo ca. 5 settimane, al fine di garantire una durevole solidità.	
	NL	Draai alle schroeven en ook dragende verbindingstukken na ca. 5 weken nog eens vast, zodat een continue stabiliteit wordt gegarandeerd.	
	PL	Prosimy po ok. 5 tygodniach dokręcić wszystkie śruby w elementach łączących. Zagwarantuje to Państwu trwałość i stabilność połączeń.	
	CZ	Dotáhněte všechny šrouby a nosné spojovací díly p řibližně po 5 týdnech, aby se zaru čila trvalá stabilita.	
	SK	Po cca 4 týždňoch dotiahnite skrutky, aby bola zaru čená ich trvalá stabilita.	
	HU	Húzza utána - kb. 5 hét múlva - az összes csavart és a teherhordó részeket ó-alkatrészeket a biztonság érdekében.	
	RO	Pentru a asigura o stabilitate de durat a, strângeți după cca. 5 săptămâni toate șuruburile, precum și toate elementele portante de leștură.	
	TR	Tüm vida ve taşıyıcı bağlantı parçalarını kalıcı bir duruş güvenliğini sağlamak için yaklaşık 5 hafta sonra tekrar sıkınız.	
	RU	Подкрутите все болты, а также несущие соединительные детали прибл. через 5 недель для обеспечения устойчивости в течение длительного времени.	
	2	D	Bitte nur mit einem Staubtuch oder leicht feuchtem Lappen reinigen. Keine scheuernden Putzmittel verwenden.
		GB	Please only clean with a duster or a damp cloth. Do not use any abrasive cleaners.
FR		Veillez nettoyer uniquement avec un chiffon à poussière ou un chiffon légèrement humide. Ne pas utiliser de détergent abrasif.	
IT		Si raccomanda di pulire solo con un panno per la polvere o uno strofinaccio umido. Non utilizzare detersivi abrasivi.	
NL		Reinig alleen met een stofdoek of een lichtjes vochtige doek. Gebruik geen schurende poetsmiddelen.	
PL		Czyszczenie nale ży wykonać wyłącznie za pomocą ściereczki lub lekkiego nawil żonego ręcznika. Nie stosować środków czyszczących do szorowania.	
CZ		Čistěte prosím jen prachovkou nebo lehce navlh čeným hadrem. Nepoužívejte drh noucí čistící prostředky.	
SK		Na čistenie používajte len prachovku alebo z ľahka navlh čenú utierku. Nepoužívajte žiadne drh nouce č istiace prostriedky.	
HU		Kérjük, csak portörít ő kendővel vagy enyhén nedves ronggyal tisztítsa. Ne használjon dörzshatású tisztítószer t.	
RO		Vă rugăm să utilizați la curățare exclusiv o cârpă de șters praful sau o cârpă ușor umezită. Nu utilizați substanțe de curățat abrazive.	
TR	Lütfen sadece bir toz beziyle veya hafif nemli yumu şek bir bezle siliniz. A şındırıcı temizlik malzemeleri kullanmayınız.		
RU	Очищайте от пыли тряпкой или слегка влажной ветошью. Не допускается применение чистящих средств, не предназначенных для ухода за мебелью.		

