

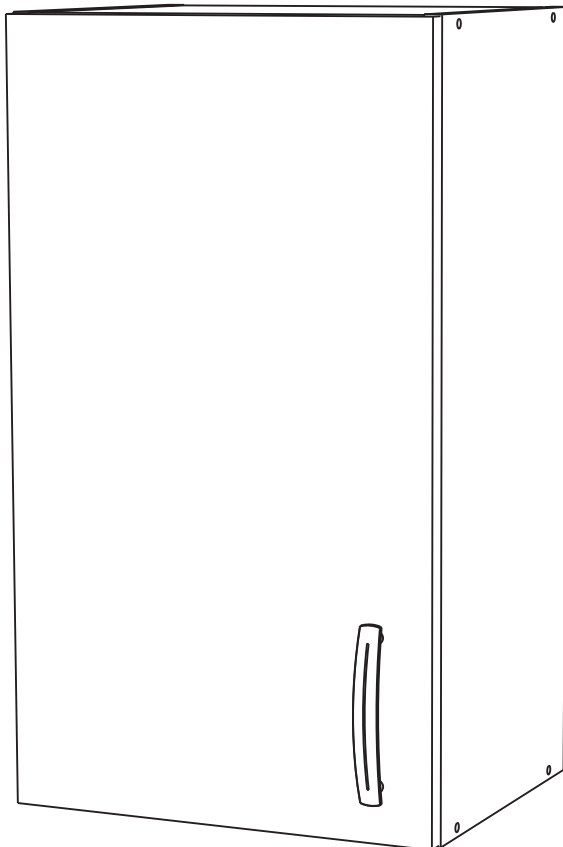

Demeyere
GROUP

178 à 184 ,rue de la Prévôté
BP 49 - 59840 PERENCHIES

249398



Info tri déchets

www.quefairedemesdechets.fr



1H 00 Mn



Fabriqué
en France

87759

01/07

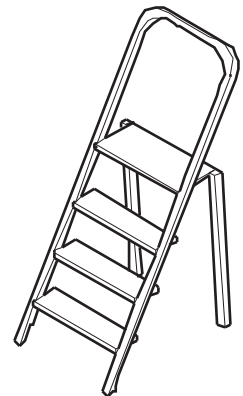
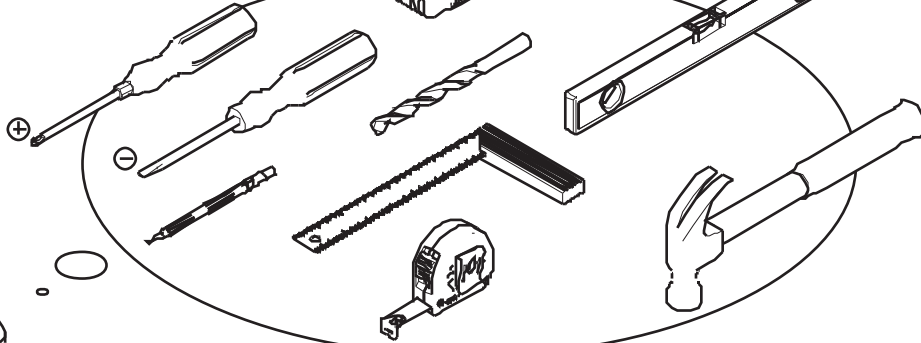
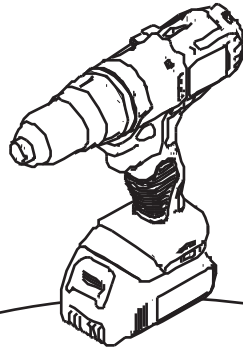
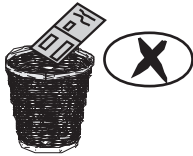
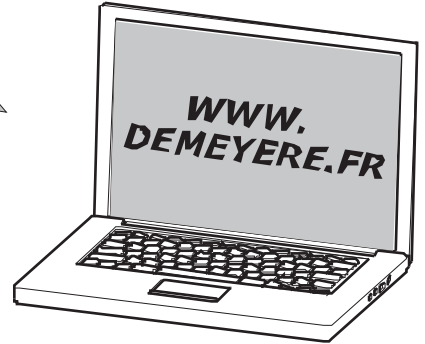
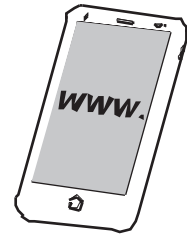
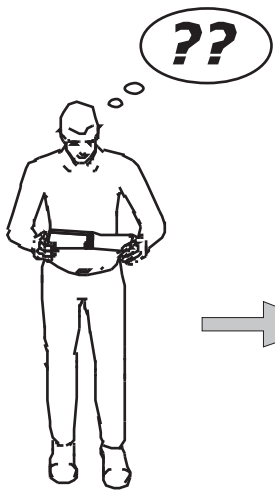

Donnez ou recyclez vos meubles.

Association

ou









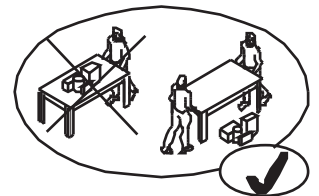
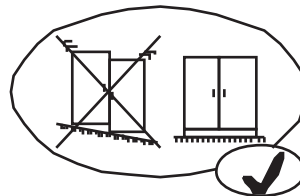
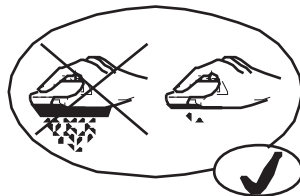
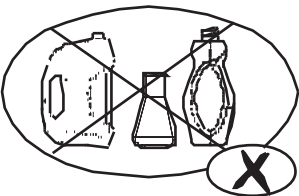



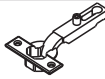

Magasin

ou

Déchèterie

<https://www.demeysere.com/fr>

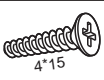

340082	X8	333009	X2	333012	X2	340750	X8	332124	X1	700	X1	434	X1
													
913	X2	8930	X1	949	X4	566	X2	706	X4	569	X2	356725	X1
													
360688	X2	360689	X4										
													

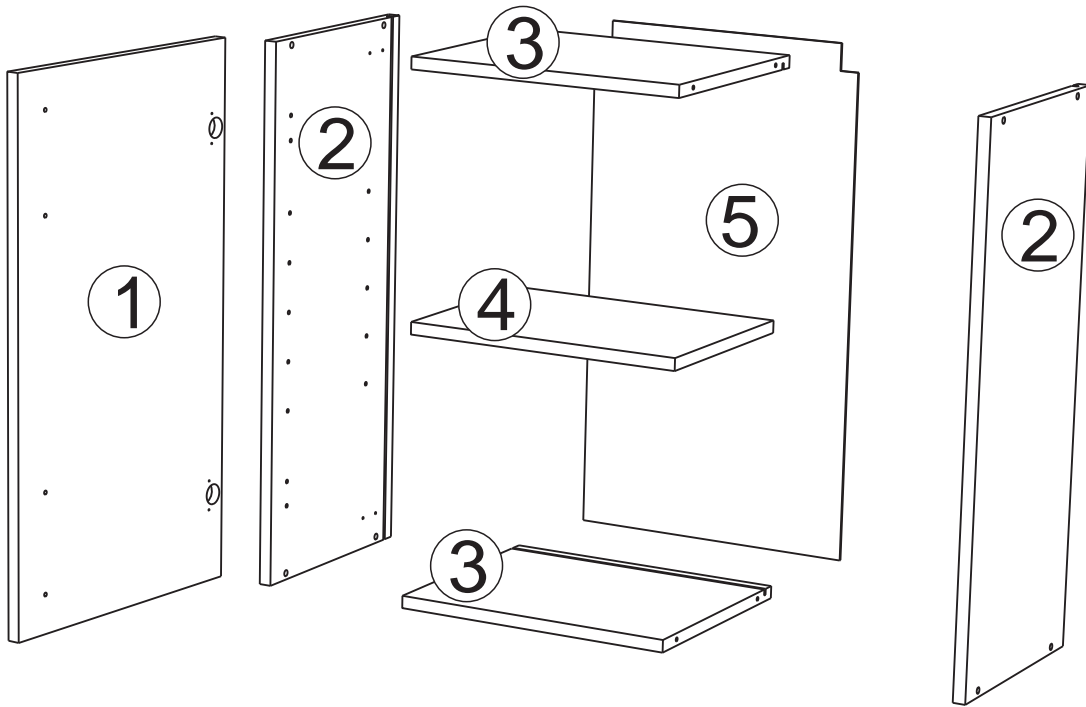

Rep	dimensions	Qté
1	697*397	1
2	700*300	2
3	368*300	2
4	368*270	1
5	682*382	1



FR

AVERTISSEMENT : MEUBLE A FIXER IMPERATIVEMENT AU MUR AFIN D'EVITER SON BASCULEMENT

- Pour installer correctement ce produit et éliminer les risques pour votre sécurité, merci de suivre exactement ce manuel d'instruction.
- Fixer le meuble au mur avec les attaches prévues à cet effet
- Les vis et les chevilles ne sont pas fournies. Utiliser des vis et des chevilles adaptées au support.

EN

WARNING: FURNITURE TO BE ATTACHED TO THE WALL TO PREVENT OVERTURNING

- Installation shall be carried out exactly according to those instructions-otherwise a safety risk can occur if incorrectly installed;
- Attach the furniture to the wall with the fastening provided for this purpose
- Screw and Pegs are not supplied. Use Screws and pegs adapted to the support.

DE

WARNUNG: DAS MÖBEL MUSS AN DER WAND BEFESTIGT WERDEN, UM ZU VERHINDERN DASS ES KIPPT

- Um das Produkt korrekt zu installieren und um Risiken für Ihre Sicherheit zu verhindern, die Gebrauchsanleitung genauestens befolgen.
- Das Möbel mit den vorgesehenen Befestigungen an einer Wand befestigen.
- Schrauben und Dübel sind nicht im Lieferumfang enthalten. Passende Schrauben und Dübel verwenden.

ES

ADVERTENCIA: ESTE MUEBLE DEBE ESTAR SIEMPRE FIJO EN LA PARED PARA EVITAR QUE VUELQUE

- Para instalar correctamente este producto y eliminar los riesgos para la seguridad, seguir exactamente las instrucciones del manual.
- Fijar el mueble a la pared con las sujeciones previstas a este efecto.
- Los tornillos y los tacos no están incluidos. Utilizar tornillos y tacos adaptados al soporte.

NL

WAARSCHUWING: MEUBEL MOET VERPLICHT AAN DE MUUR BEVESTIGD WORDEN ZODAT HET NIET KAN OMVALLEN

- Om dit product correct te installeren en alle risico's voor uw veiligheid te elimineren, gelieve de instructies in deze handleiding nauwgezet op te volgen.
- Zet het meubel vast aan de muur met de hiertoe voorziene bevestigingen.
- De schroeven en pluggen zijn niet meegeleverd. Gebruik schroeven en pluggen die geschikt zijn voor het materiaal van de muur.

IT

AVVERTENZA: MOBILE DA FISSARE IMPERATIVAMENTE AL MURO PER EVITARE CHE SI RIBALTI

- Per installare correttamente questo prodotto ed eliminare i rischi per la vostra sicurezza, si prega di seguire esattamente il manuale d'istruzioni.
- Fissare il mobile al muro con gli appositi ganci.
- Le viti e i tasselli non sono forniti. Utilizzare viti e tasselli adatti al supporto.

PT

ADVERTÊNCIA: MÓVEL A FIXAR OBRIGATORIAMENTE À PAREDE PARA EVITAR A SUA QUEDA

- Para instalar corretamente este produto e eliminar os riscos para a sua segurança, é favor seguir exatamente este manual de instruções.
- Fixe o móvel à parede com as fixações previstas para o efeito
- Os parafusos e as cavilhas não são fornecidos. Utilize parafusos e cavilhas adaptados ao suporte.

PL





OSTRZEŻENIE: MEBEL NALEŻY PRZYMOCOWAĆ DO ŚCIANY, ABY UNIKNAĆ JEGO PRZEWRÓCENIA

- Aby prawidłowo zainstalować ten produkt i wyeliminować zagrożenie dla bezpieczeństwa użytkownika, należy postępować zgodnie z niniejszą instrukcją.
- Przymocować mebel do ściany za pomocą mocowań przewidzianych w tym celu.
- Śruby i nakrętki nie znajdują się w zestawie. Użyć śrub i nakrętek dostosowanych do wspornika.



CR

UPOZORENJE : UČVRSTITE ORMARIĆ NA ZID KAKO BISTE SPRIJEČILI NJEGOVO LJULJANJE

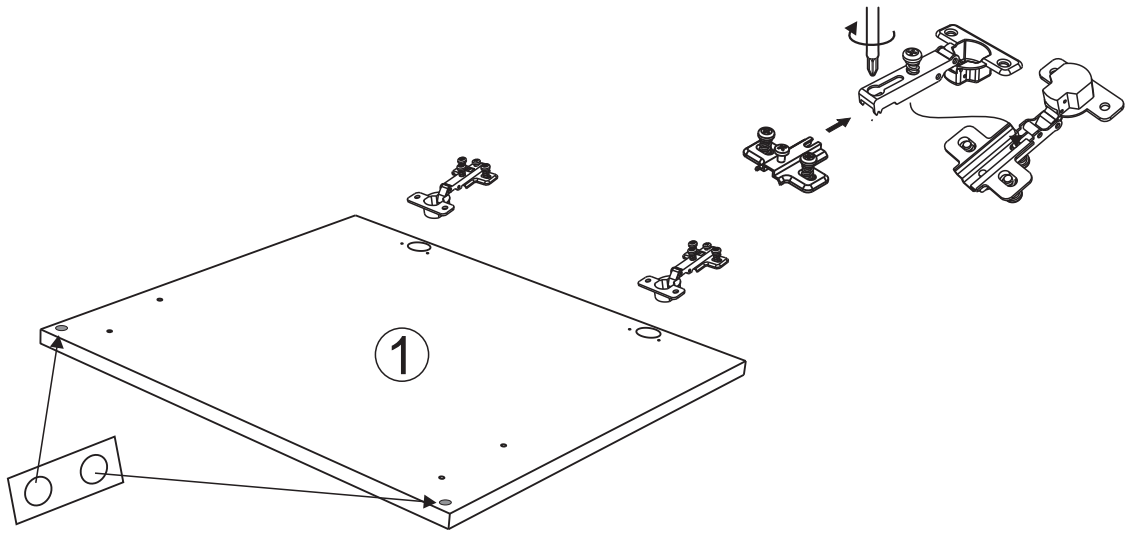
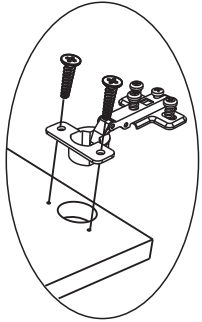

- Kako biste pravilno postavili ovaj proizvod i uklonili sigurnosne rizike kojima se izlažete, pridržavajte se strogo ovog priručnika s uputama.
- Postavite ormarić na zid pripadajućim sponama.Vijci i svornjci ne isporučuju se. Upotrijebite nosne vijke i svornjke.

1	333012	X2	949	X4	8930	X1	333009	X2
								



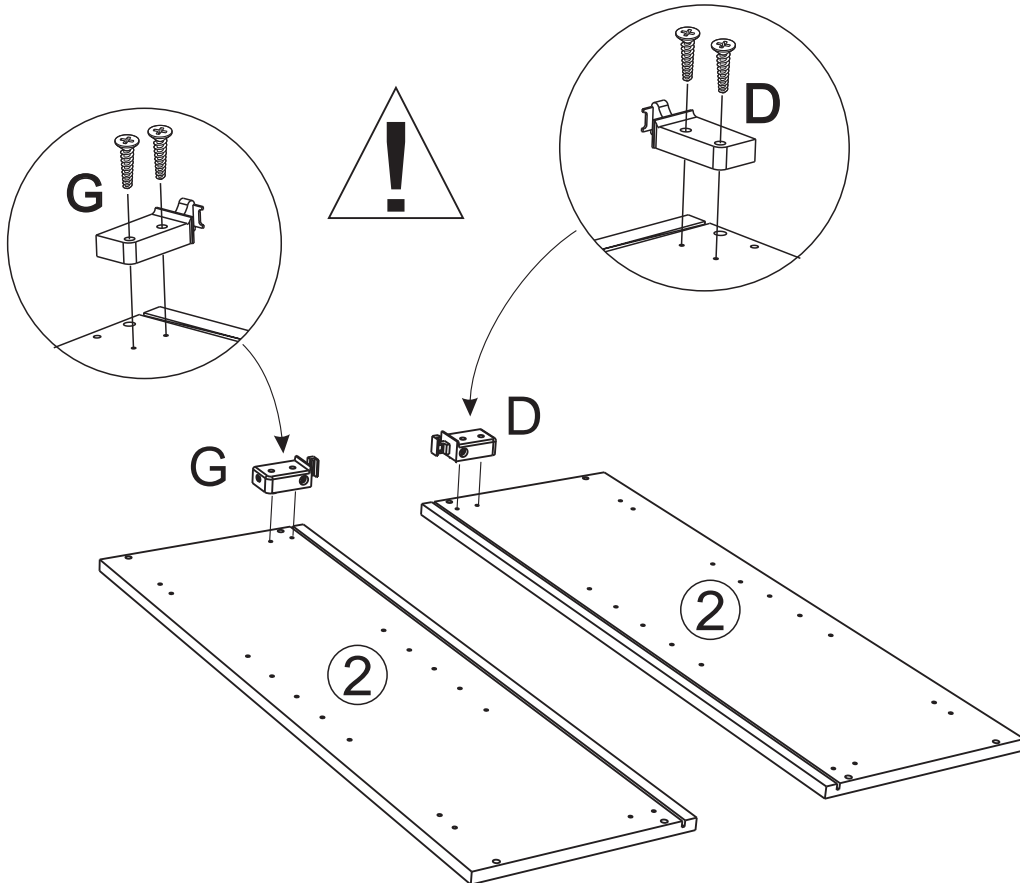

2	356725	X1	360689	X4
				

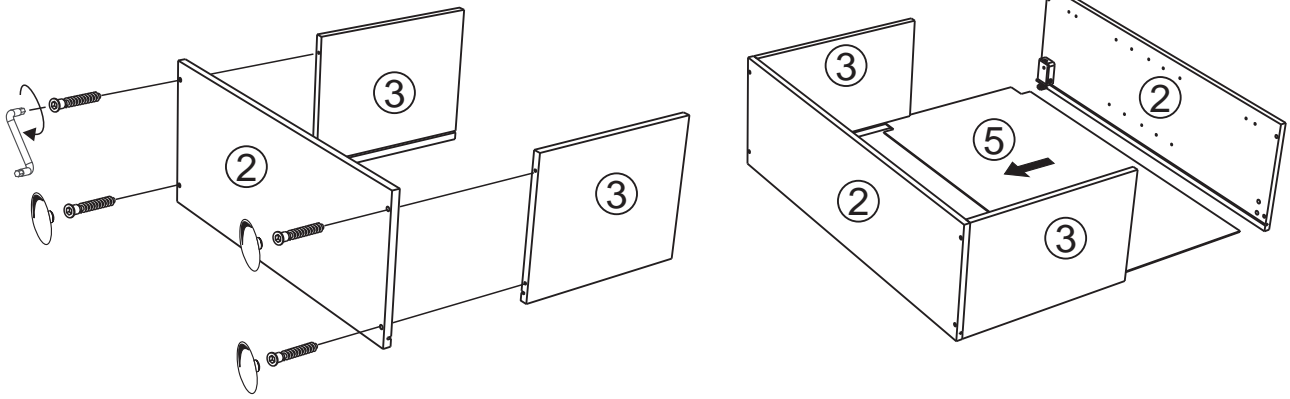

3	340750	X4	340082	X4	434	X1
						



4	340750	X4	340082	X4	434	X1
						

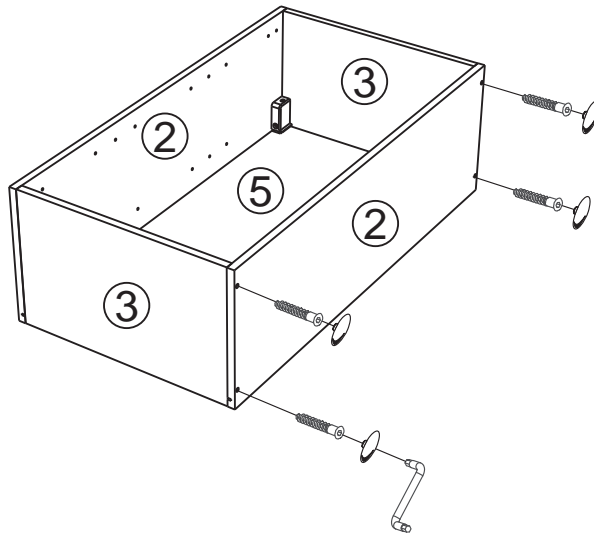





5	360688	X2
		

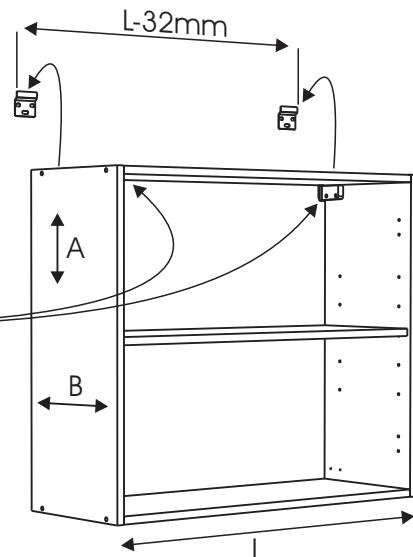
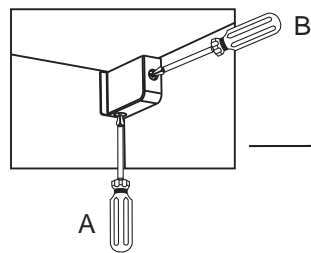

www.Demeyere.fr

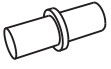

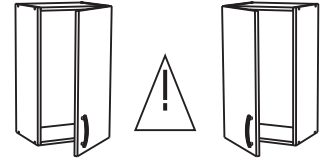

6	332124	X1	913	X2	706	X4	700	X1
								

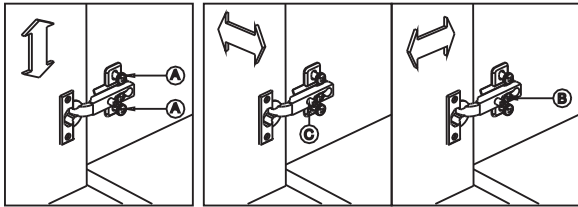
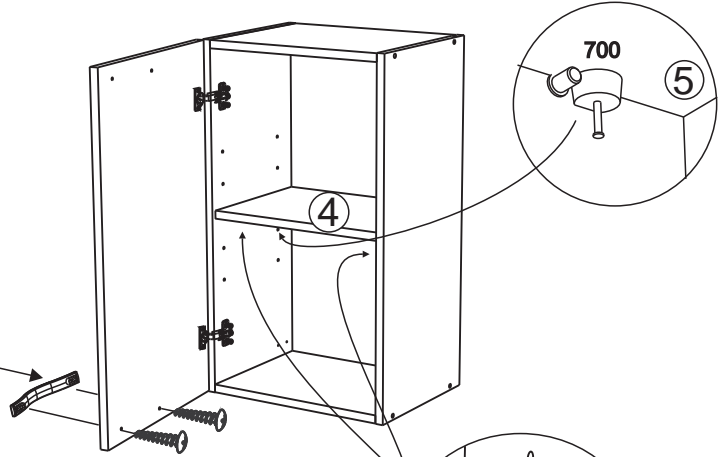
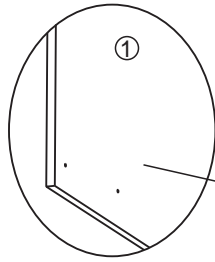

www.Demeyere.fr



7	566	X2	569	X2
				



www.Demeyere.fr

