

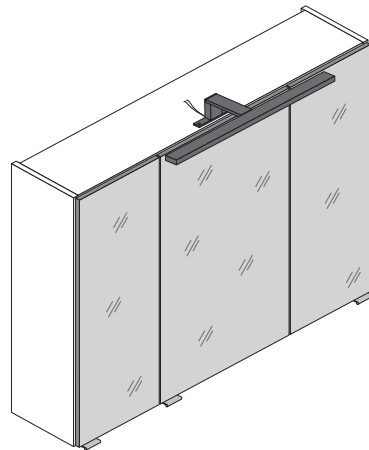

88085.532

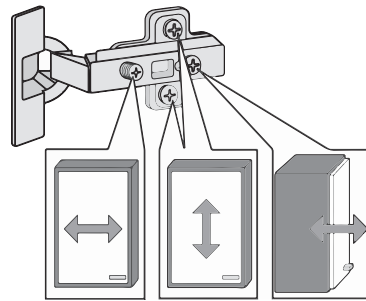

3D-Effekt

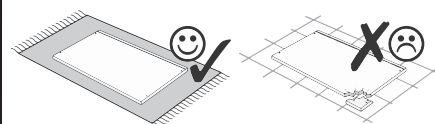
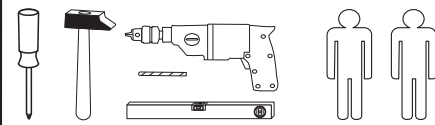
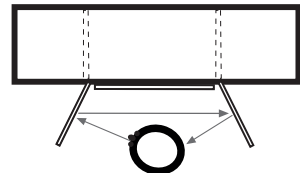

1 4 x 2802	2 4 x 2801	gedämpft 3 x 1506	ungedämpft 3 x 1507	6 x 1614
6 24 x 2819	7 25 x 2862	8 3 x	3 x 15 6 x 2803	4 x 30 4 x 2812
5,8 x 55 2 x 2840	8 x 30 2 x 2842	13 2 x 2843	14 6 x 2865	8 x 30 16 x 2861
Leim 1 x 2863	3,5 x 15 26 x 2804	18 1 x 2 x	19 1 x 2 x	

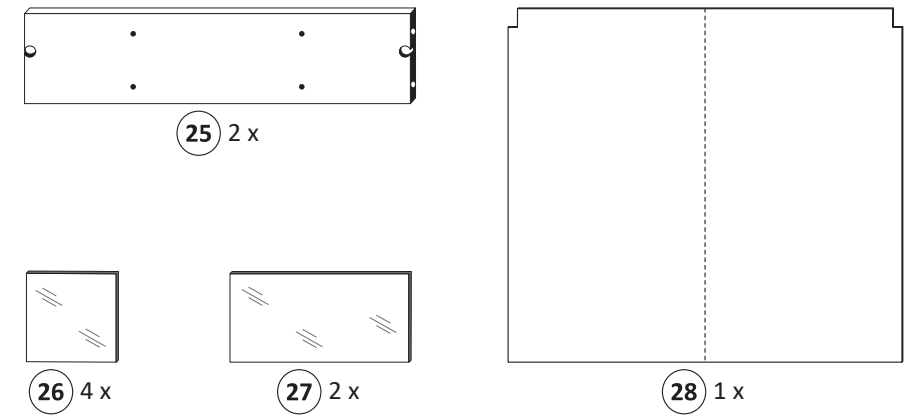
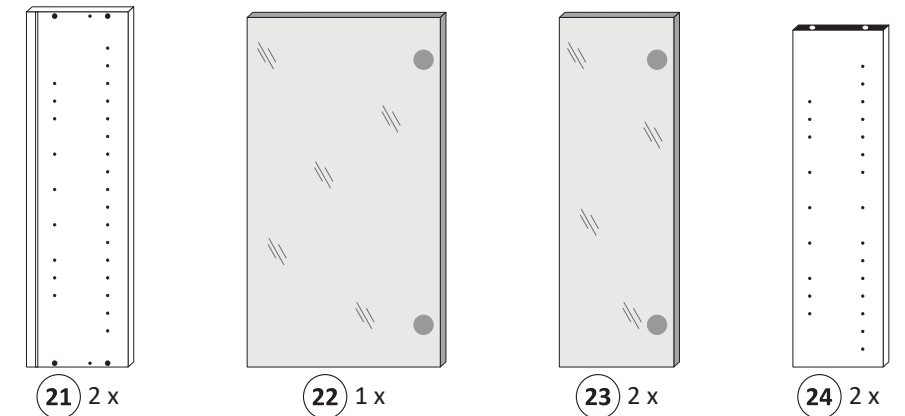
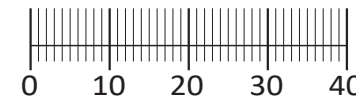

Held Möbel GmbH
Vogelparadies 9
32457 Porta Westfalica

Mail:
info@held-moebel.de



Diese Aufbauanleitung muss bis zum Ende der Nutzungszeit ihres Produktes sorgfältig aufbewahrt werden! Im Rahmen des Produkthaftungsgesetzes müssen Sie die Herstellerkennzeichnung aufbewahren. Zusätzlich kann Ihnen die Aufbauanleitung bei Ersatzteilbestellungen helfen, Bauteile und Beschläge eindeutig zu identifizieren.

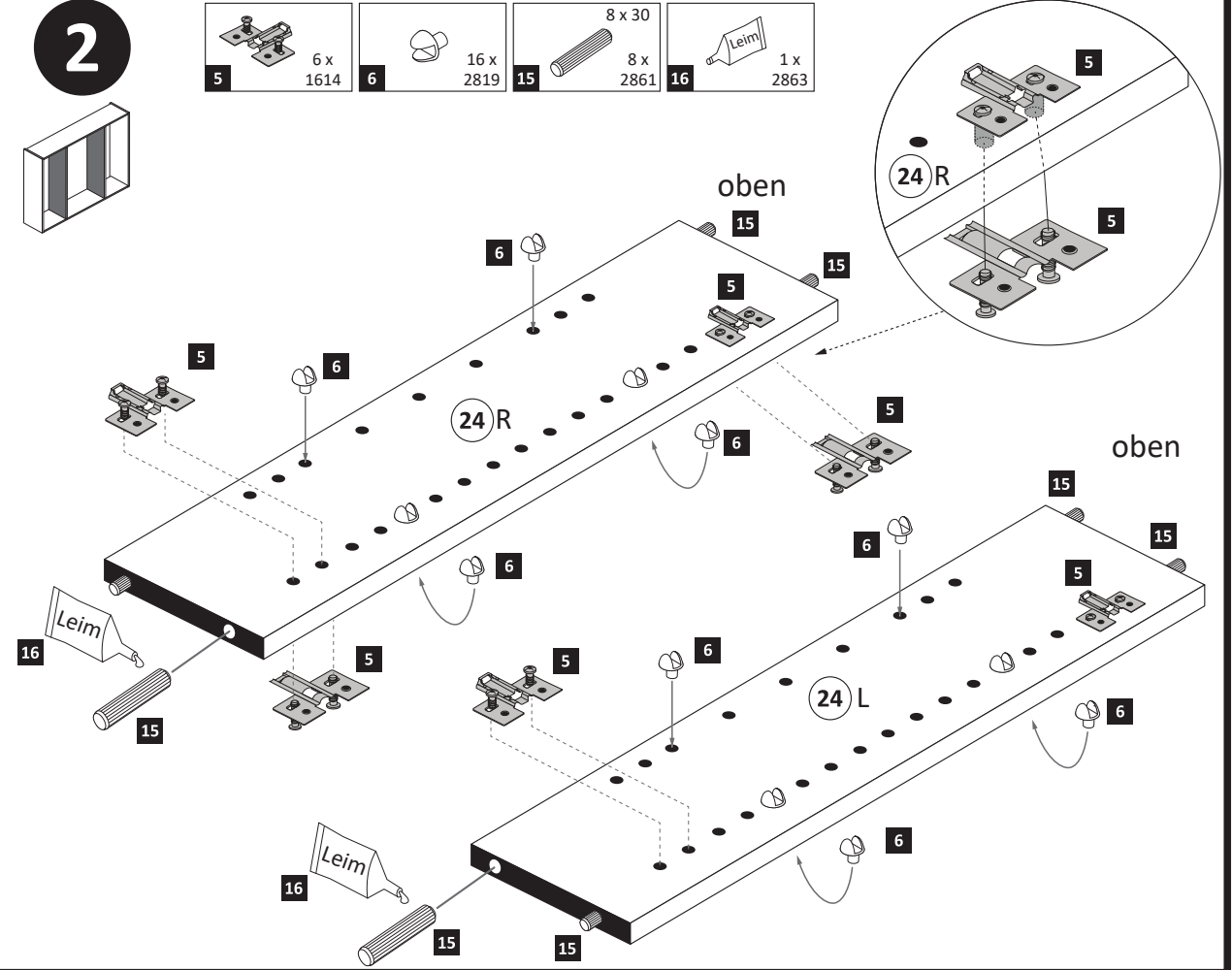
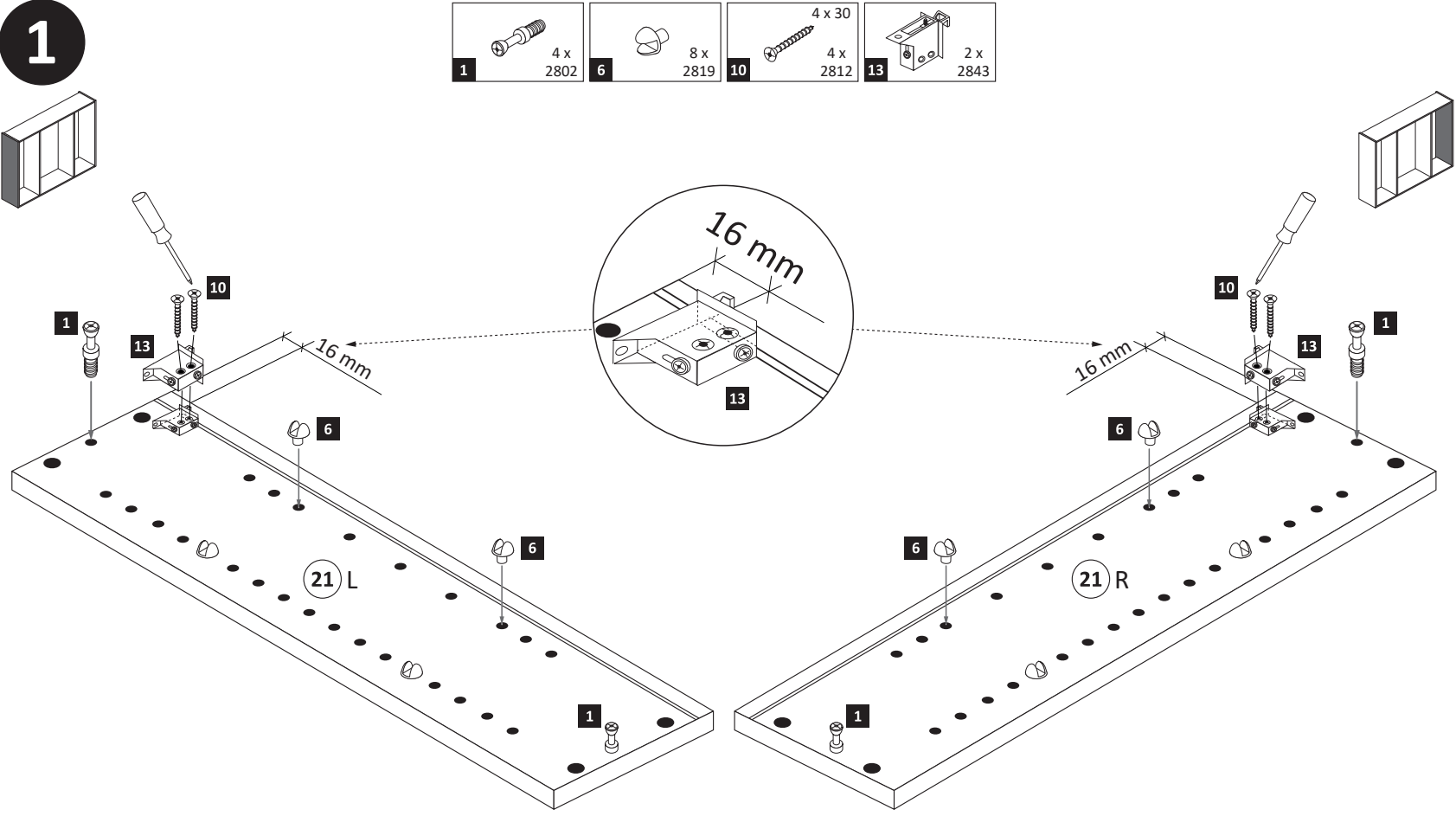

3

- 2 4 x 2801
- 15 8 x 30 8 x 2861
- 16 1 x 2863

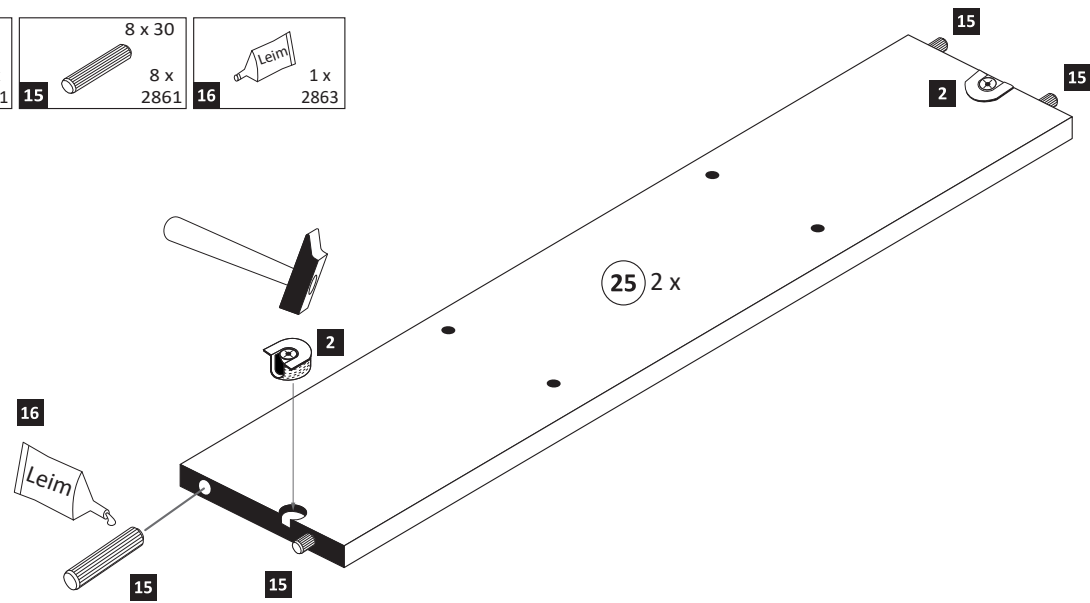

4

- 17 3,5 x 15 2 x 2804

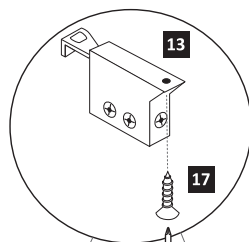
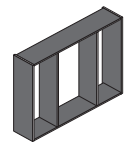

- 16 1 x 2863
- 20 min.
- D Leim
 - GB Glue
 - NL Lijm
 - PL Klej
 - TR Tutkal
 - F Colle
 - I Colla

Ansicht von links

Ansicht von rechts

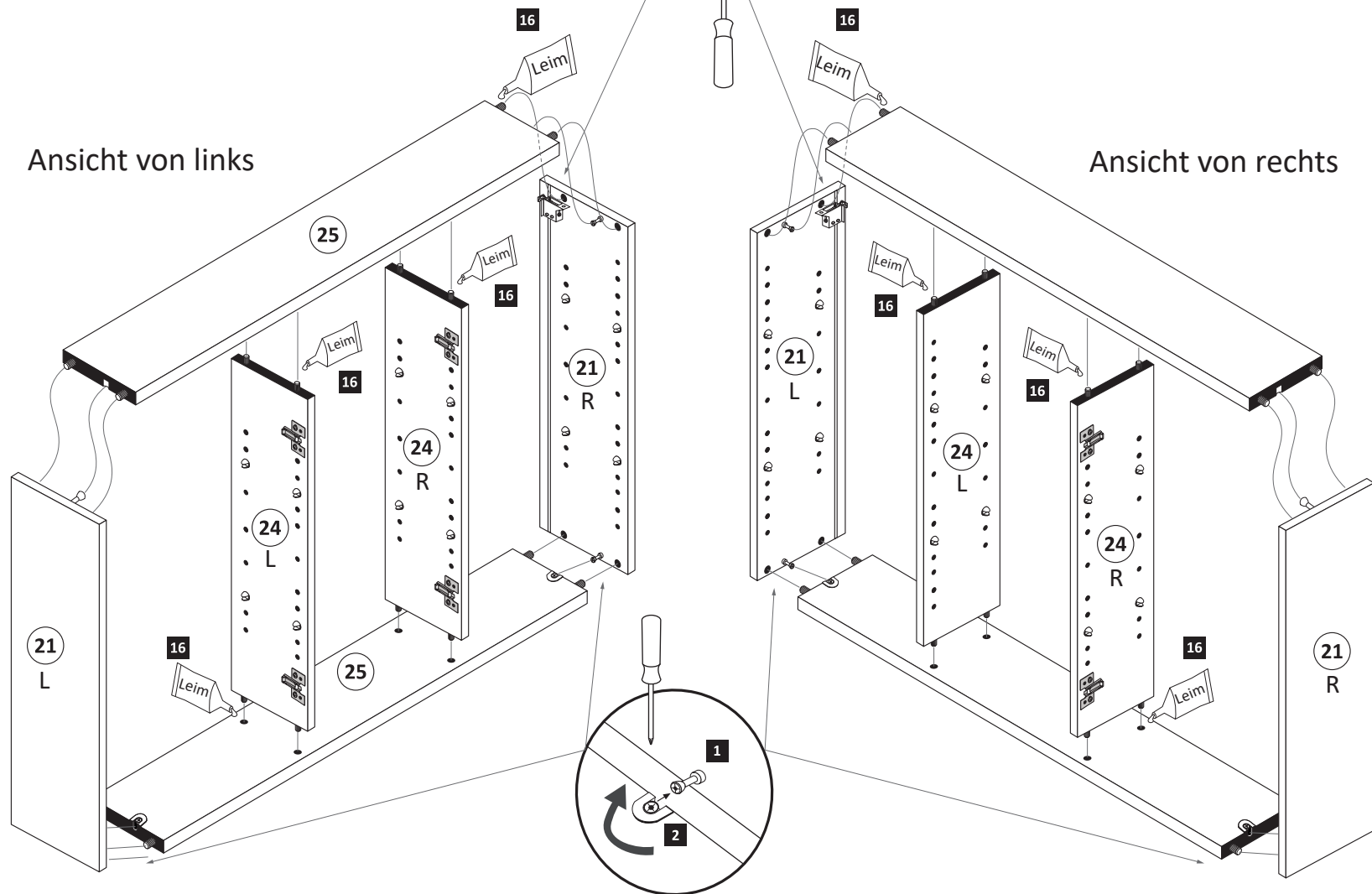

5

Bitte nur eine Variante auswählen und den entsprechenden Ausschnitt in einer Größe von maximal Trafobreite wie Trafohöhe - 10 mm aussägen. Trafomontage wird im Schritt 7 durchgeführt.

Variante 1: Trafomontage unten

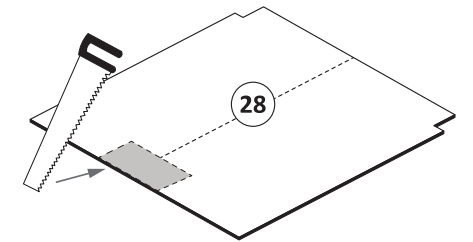
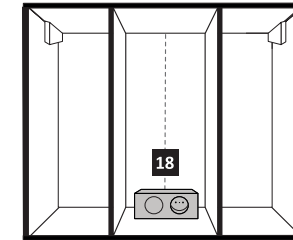

Variante 2: Trafomontage oben

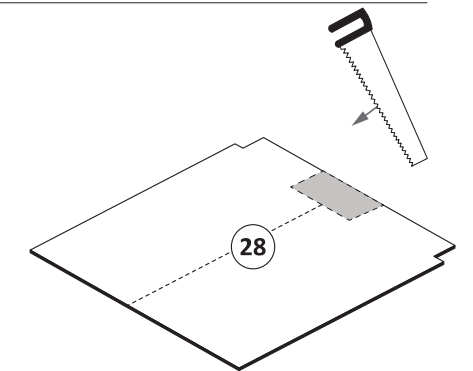
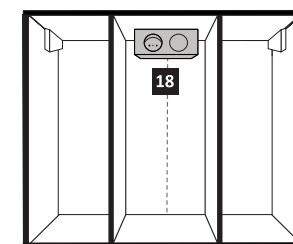

6

- 7 25 x 2862

ACHTUNG!
Folgende Montageschritte mit dem Beispiel „Trafomontage Variante unten links“!

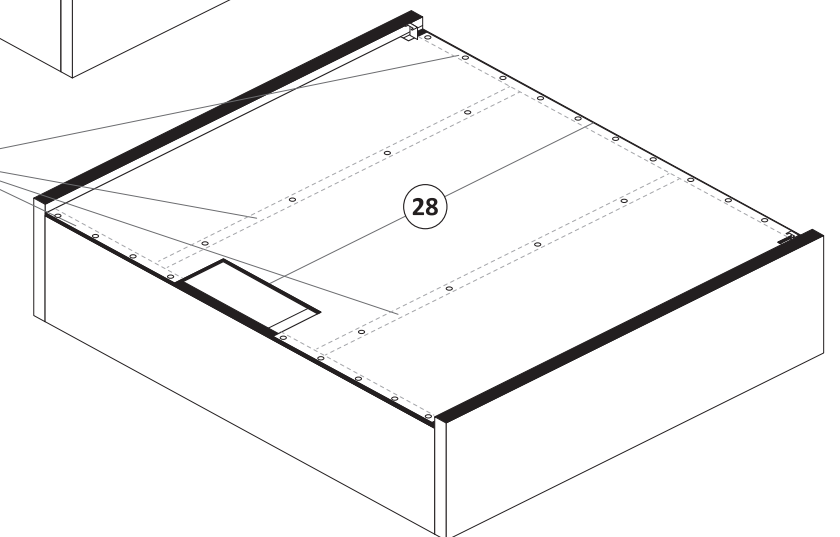
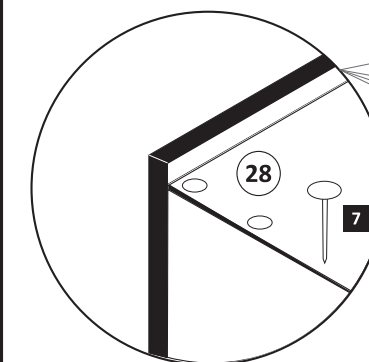
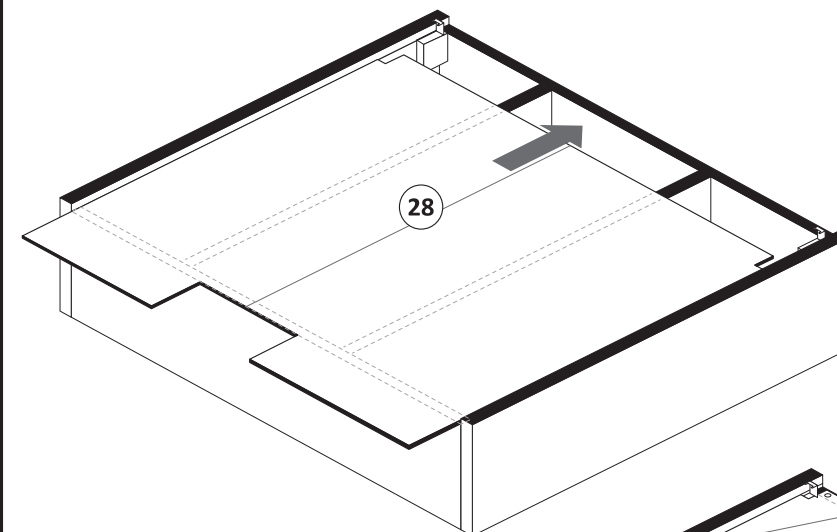

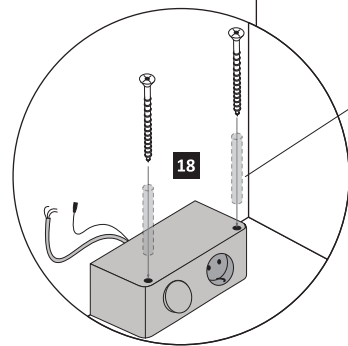
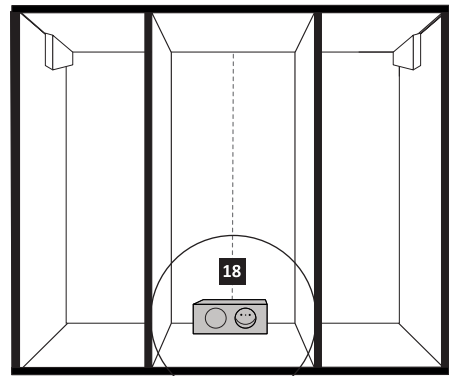
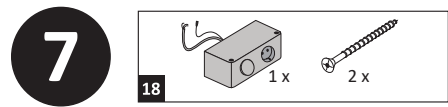

Achtung !!
Die Distanzhülsen sind optional im Lieferumfang.
Nur bei Bedarf nutzen.

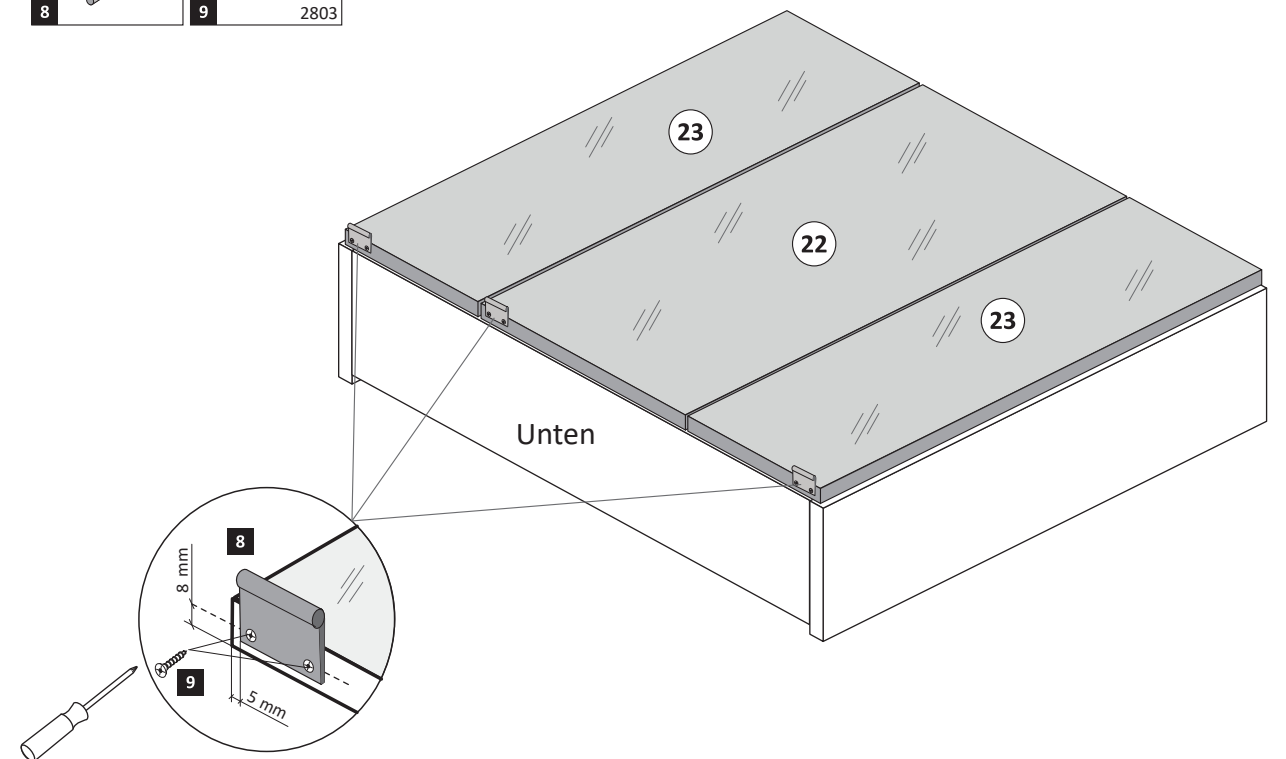
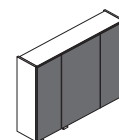
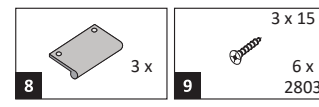
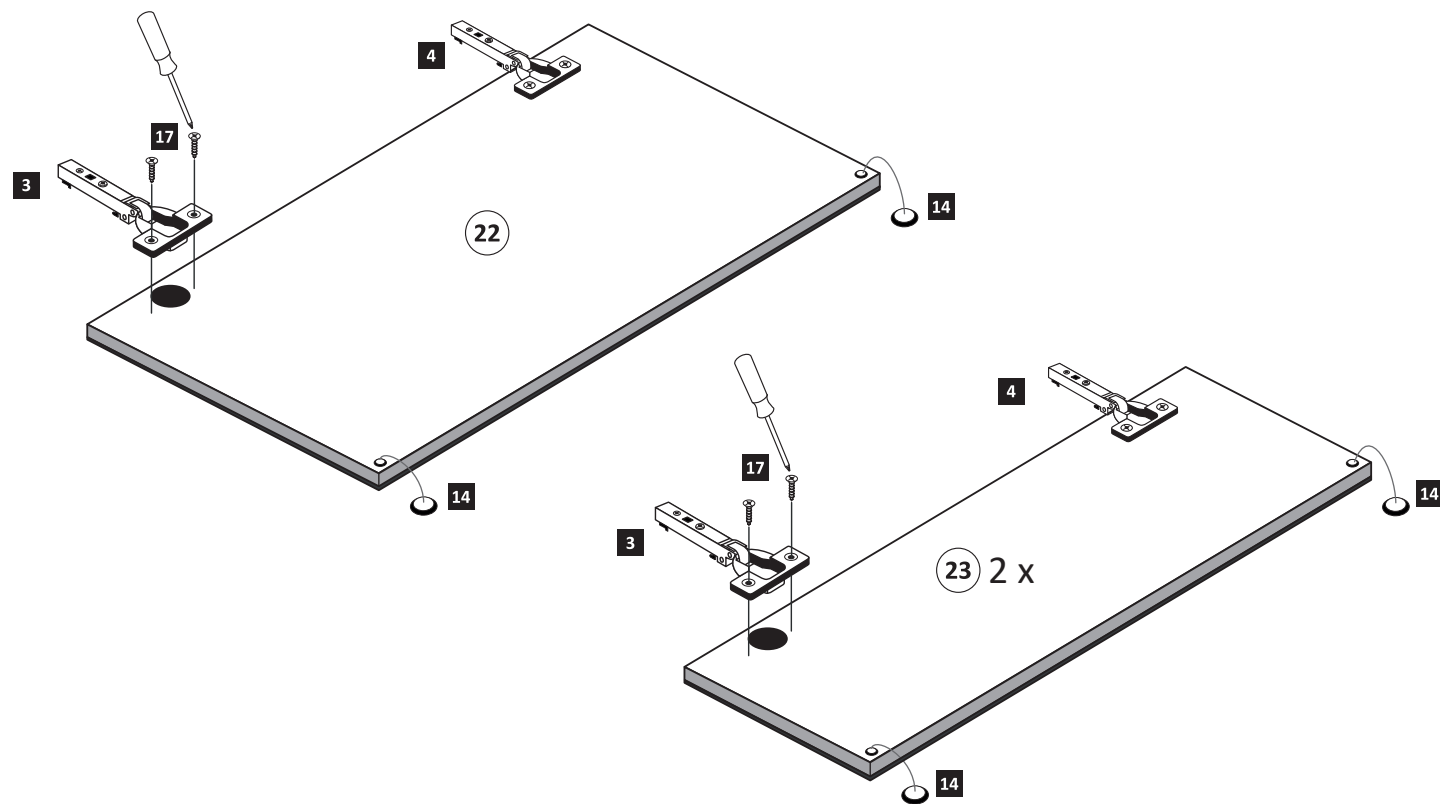
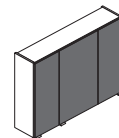
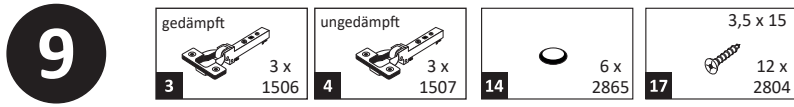
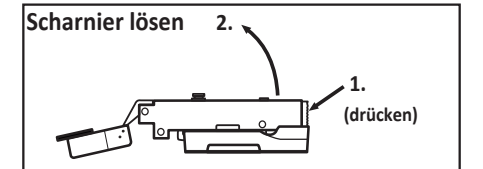
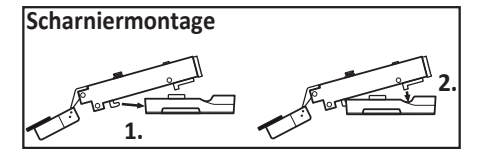
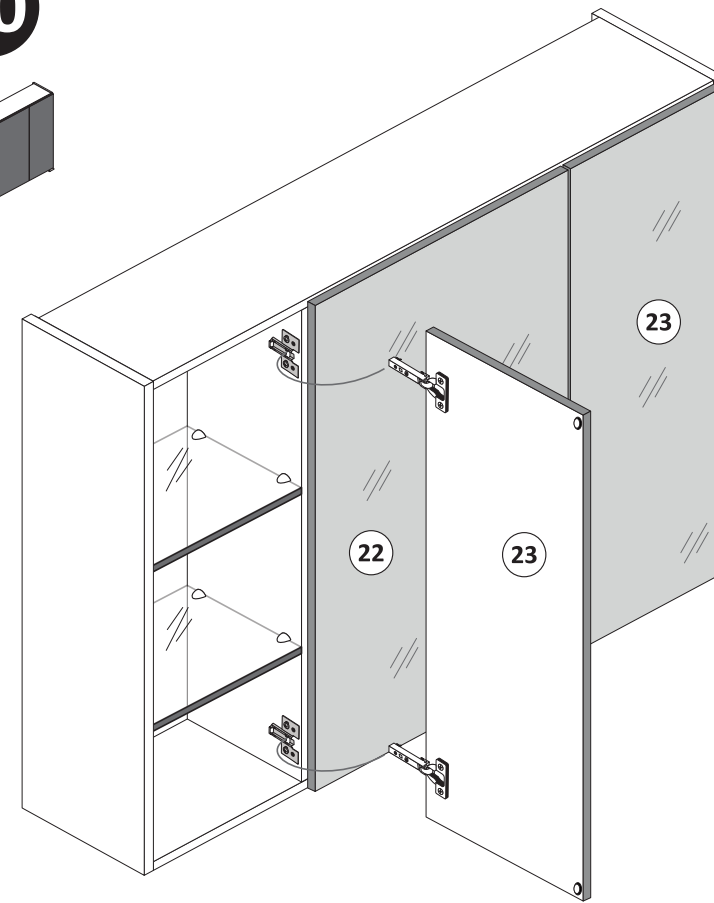
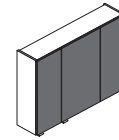
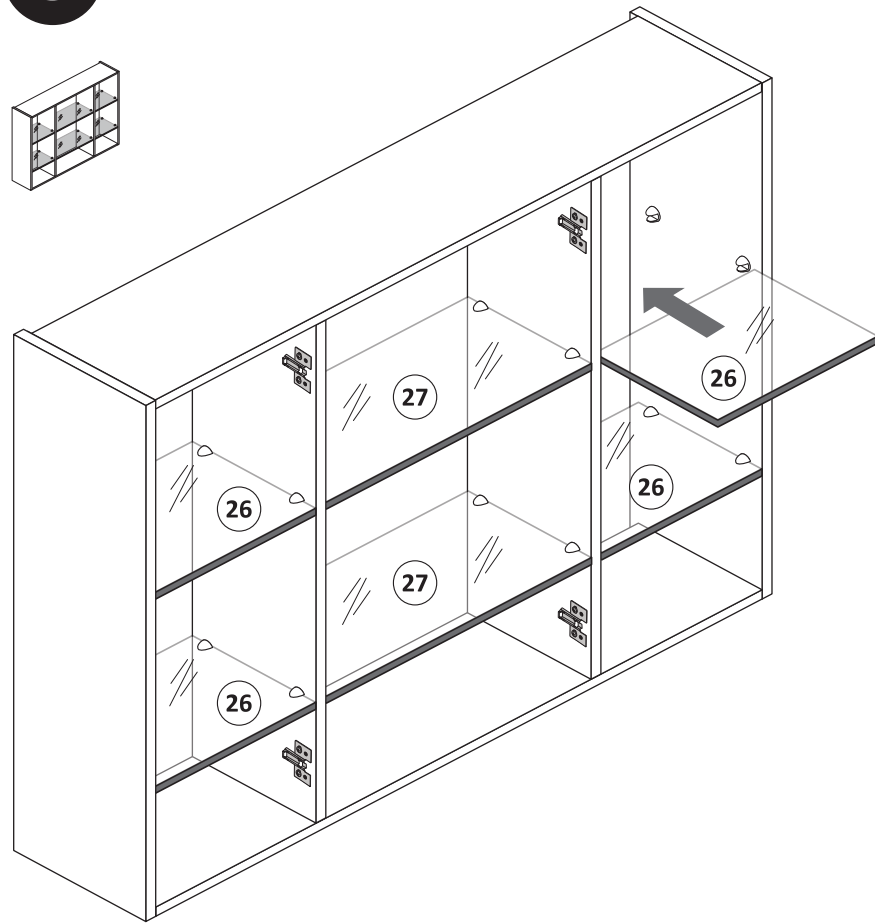
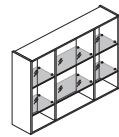

12

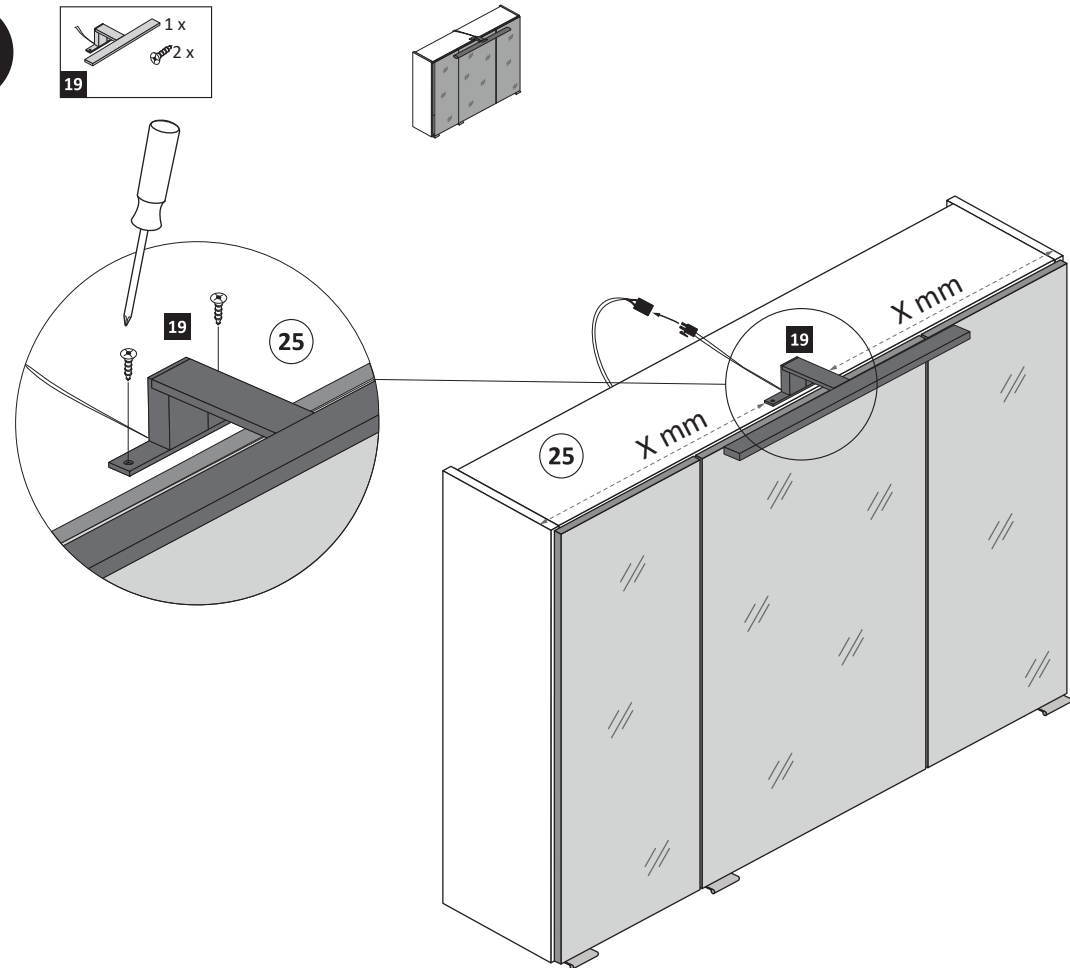

13

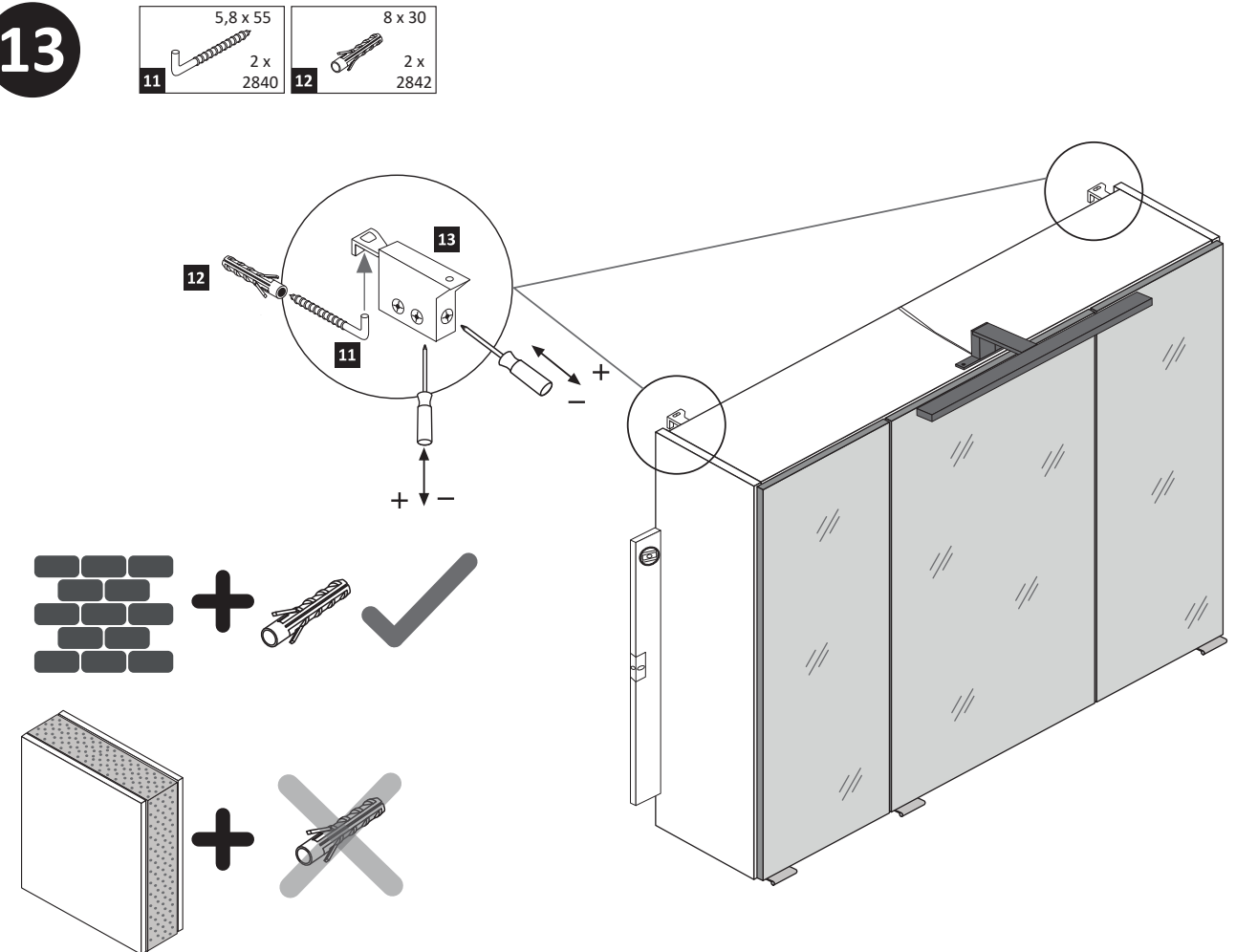

14

3,5 x 15
12 x 2804
17

1. Türen einstellen.

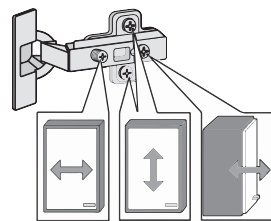

Achtung !!
Aus Sicherheitsgründen ist die Montage der Sicherungsschrauben zwingend notwendig. Nachdem montieren der Sicherungsschrauben ist die Höheneinstellung der Türen nicht mehr möglich!



2. Sicherungsschrauben montieren.

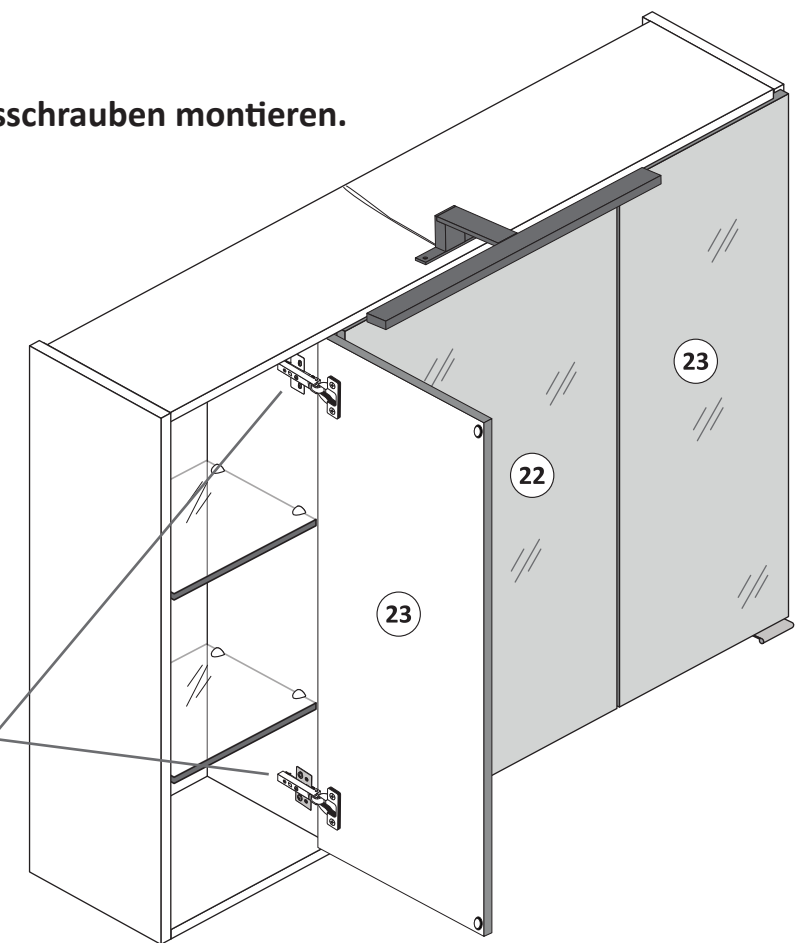
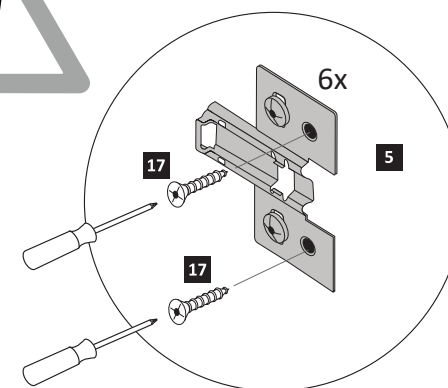
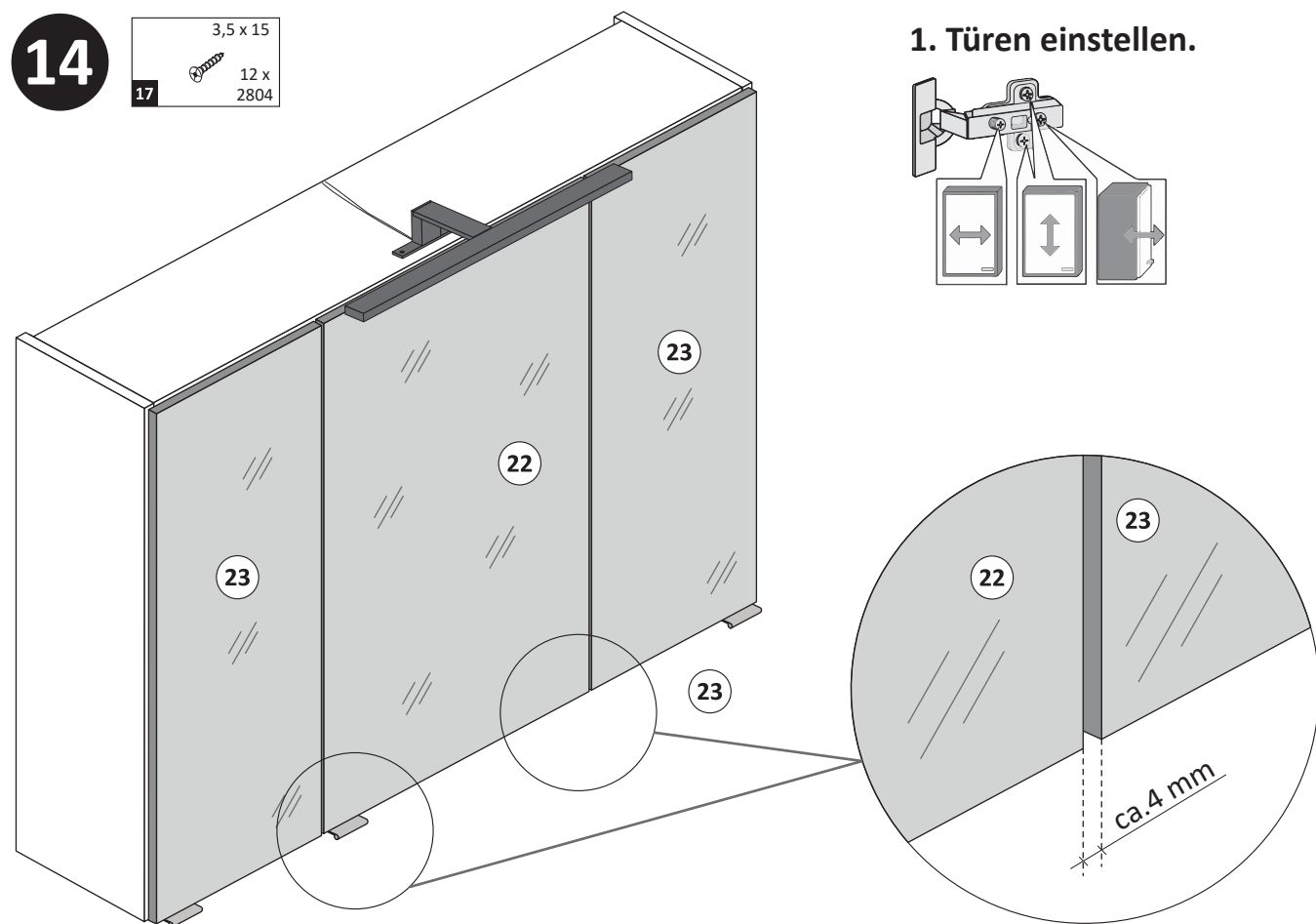



88085.532

1 4 x 2802	2 4 x 2801	gedämpft 3 x 1506	ungedämpft 3 x 1507	6 x 1614
6 24 x 2819	7 25 x 2862	8 3 x	3 x 15 6 x 2803	4 x 30 4 x 2812
5,8 x 55 2 x 2840	8 x 30 2 x 2842	13 2 x 2843	6 x 2865	8 x 30 16 x 2861
Leim 1 x 2863	3,5 x 15 26 x 2804	18 1 x 2 x	19 1 x 2 x	

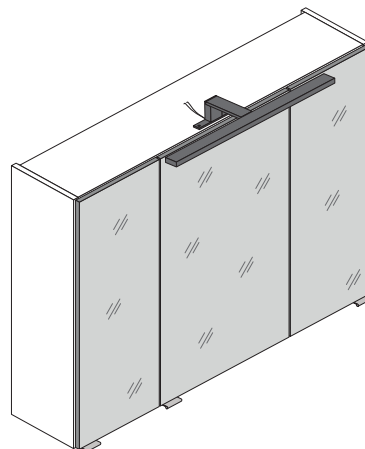
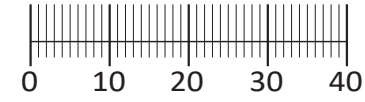
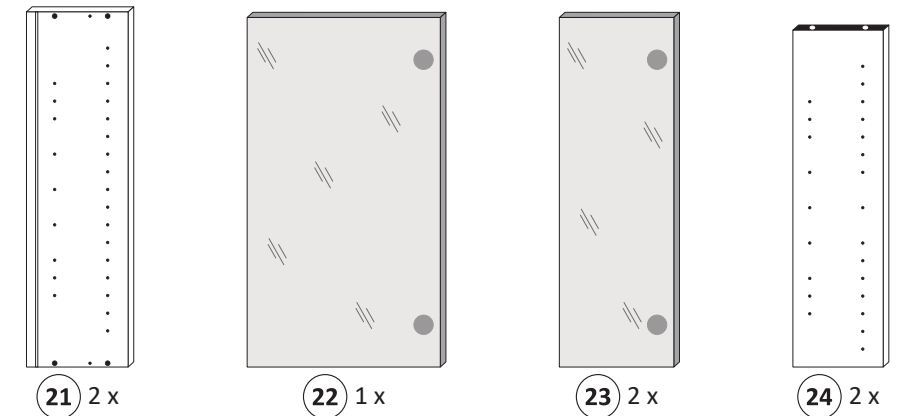

3D-Effekt

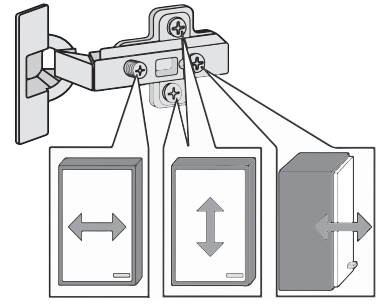
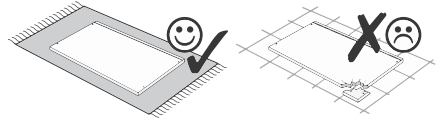
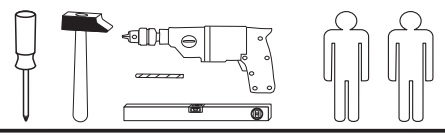
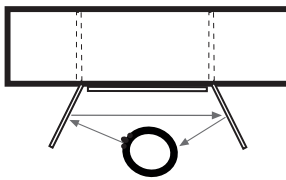

Held Möbel GmbH
Vogelparadies 9
32457 Porta Westfalica

Mail:
info@held-moebel.de



Diese Aufbauanleitung muss bis zum Ende der Nutzungszeit ihres Produktes sorgfältig aufbewahrt werden! Im Rahmen des Produkthaftungsgesetzes müssen Sie die Herstellerkennzeichnung aufbewahren. Zusätzlich kann Ihnen die Aufbauanleitung bei Ersatzteilbestellungen helfen, Bauteile und Beschläge eindeutig zu identifizieren.

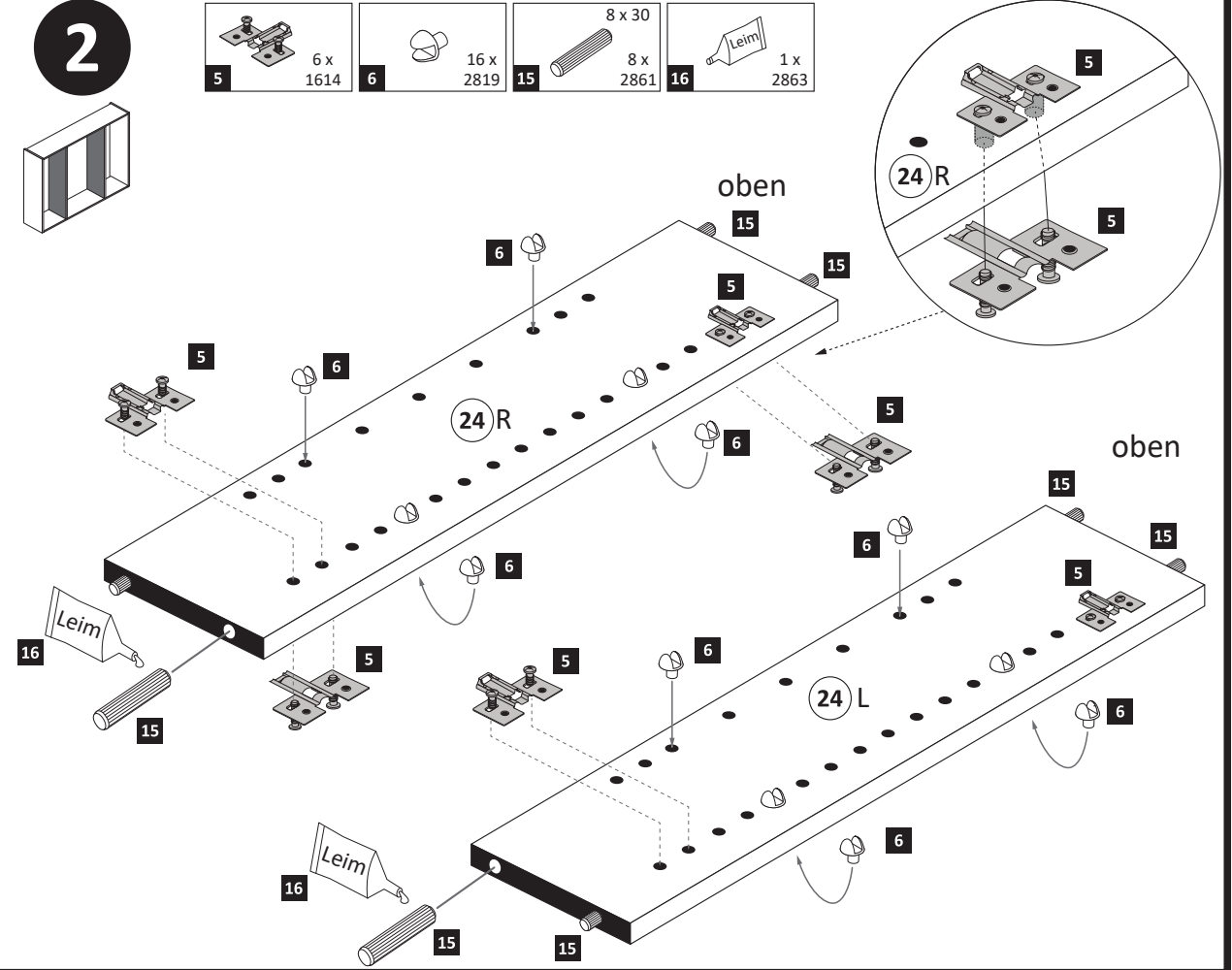
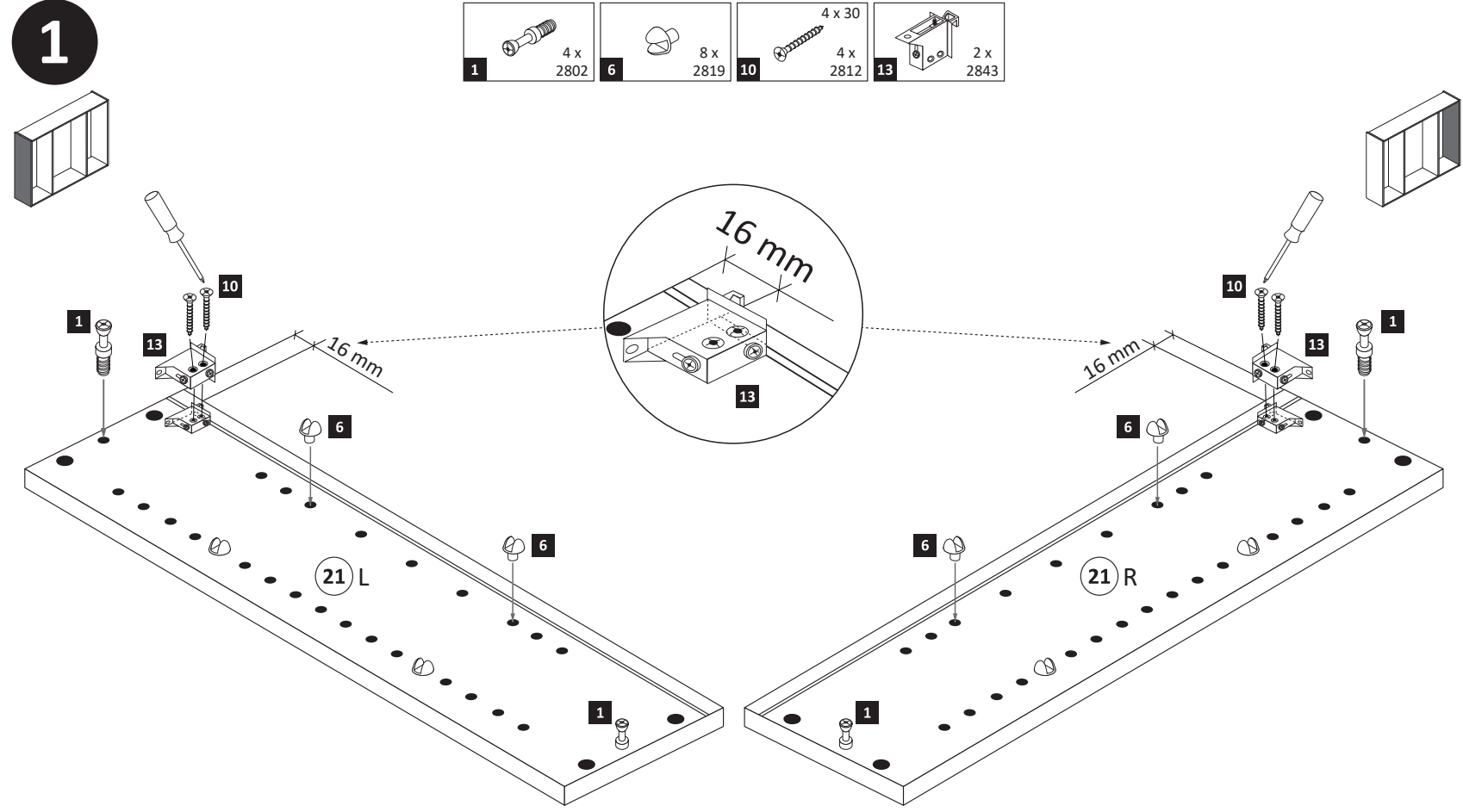
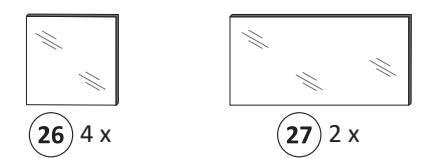
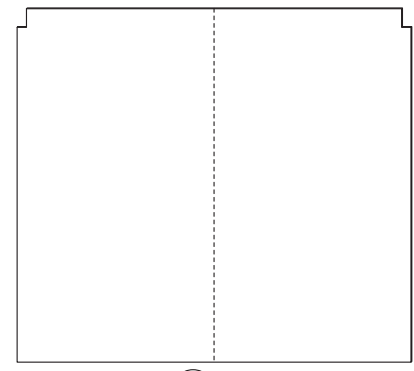
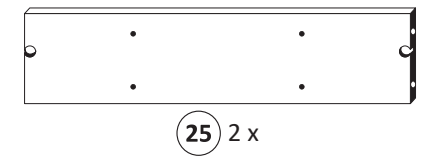

3

- 2 4 x 2801
- 15 8 x 30 8 x 2861
- 16 1 x 2863

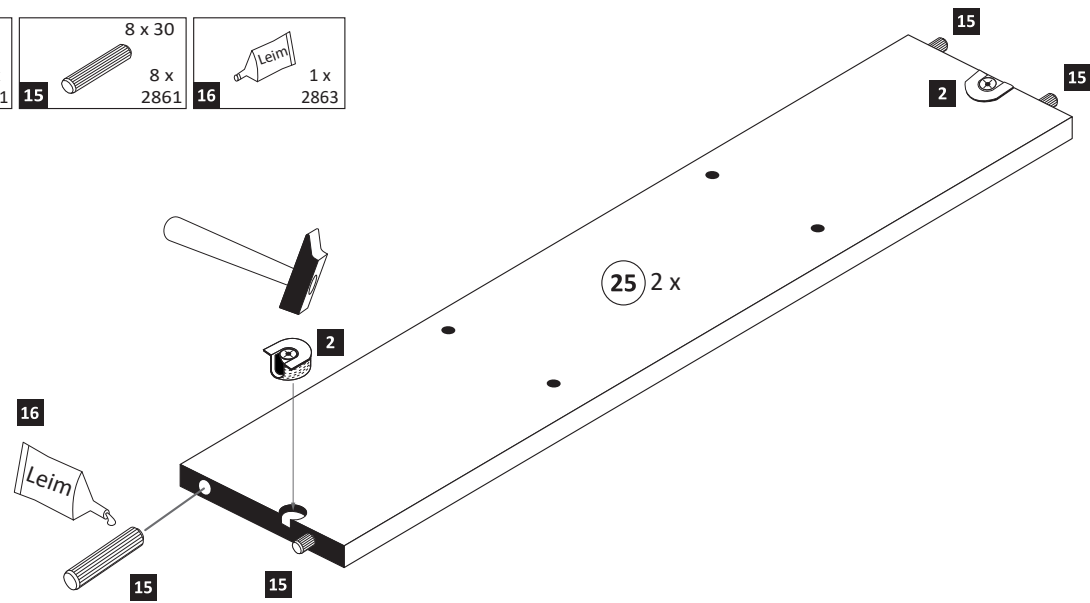

4

- 17 3,5 x 15 2 x 2804

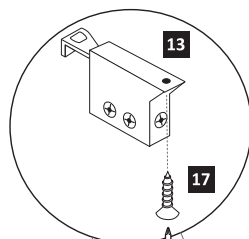
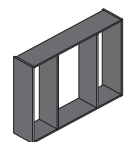

- 16 1 x 2863
 - D Leim
 - GB Glue
 - NL Lijm
 - PL Klej
 - TR Tutkal
 - F Colle
 - I Colla
- 20 min.

Ansicht von links

Ansicht von rechts

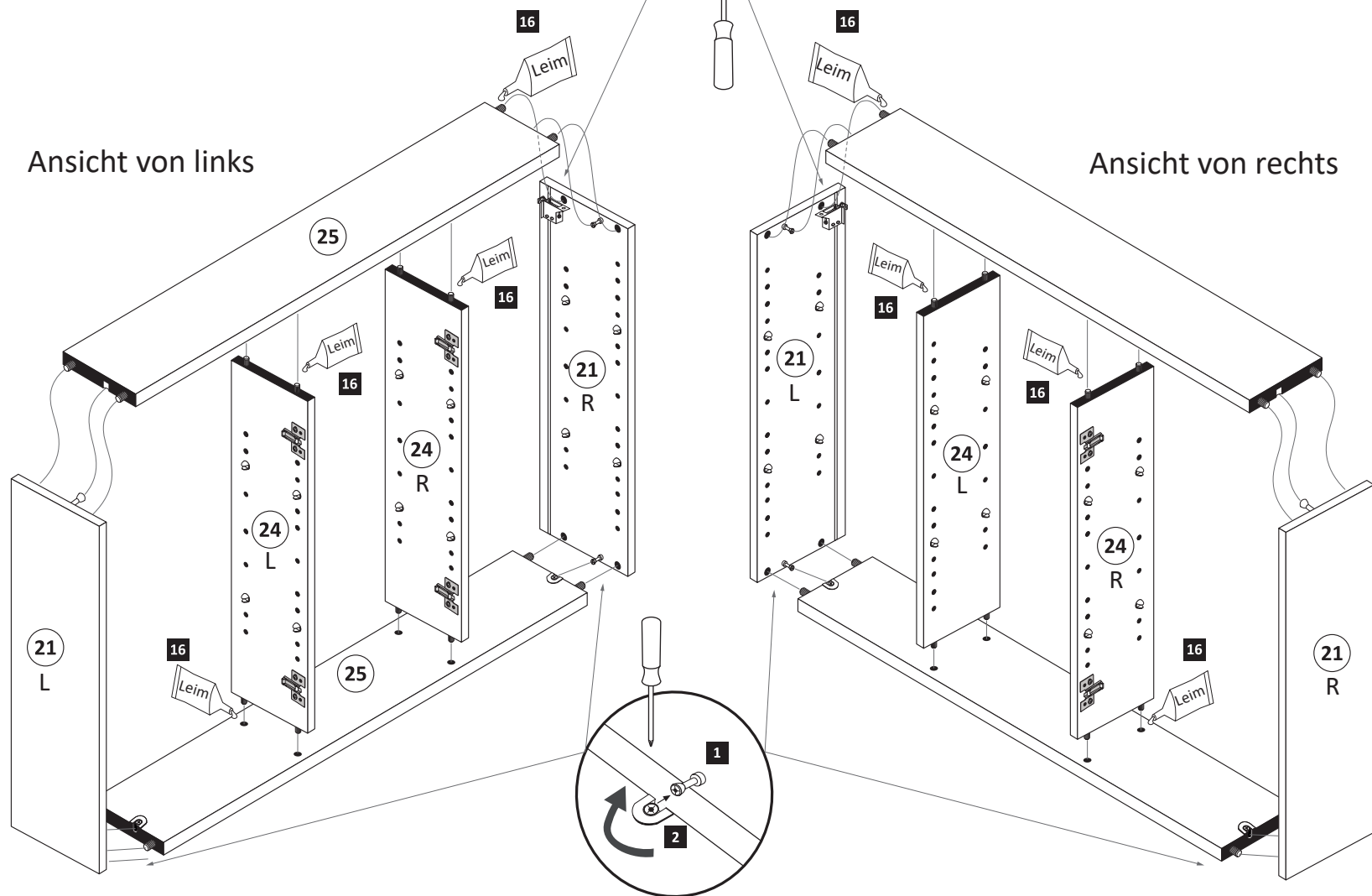

5

Bitte nur eine Variante auswählen und den entsprechenden Ausschnitt in einer Größe von maximal Trafobreite wie Trafohöhe - 10 mm aussägen. Trafomontage wird im Schritt 7 durchgeführt.

Variante 1: Trafomontage unten

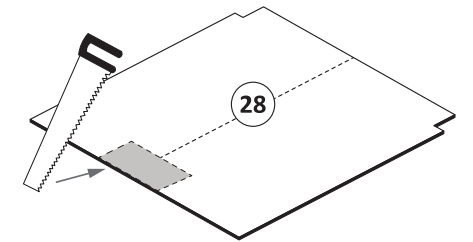
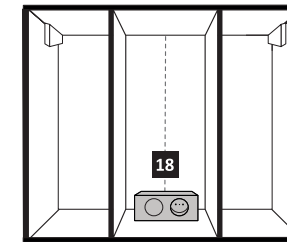

Variante 2: Trafomontage oben

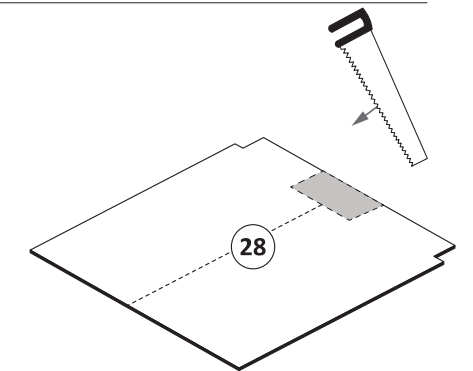
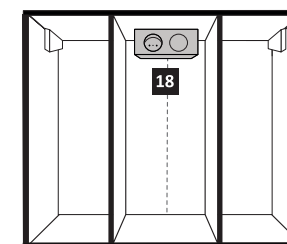

6

- 7 25 x 2862

ACHTUNG!
Folgende Montageschritte mit dem Beispiel „Trafomontage Variante unten links“!

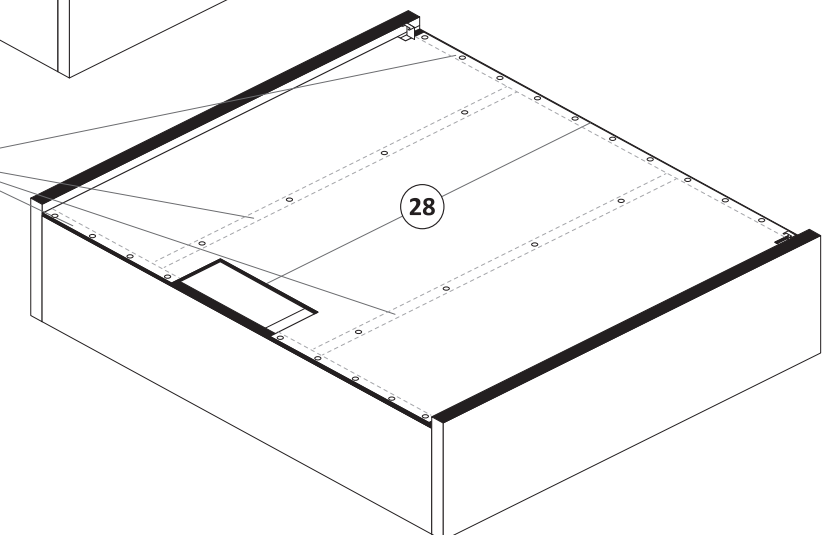
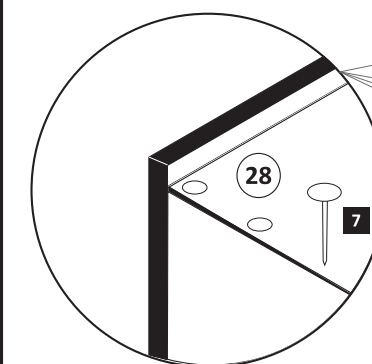
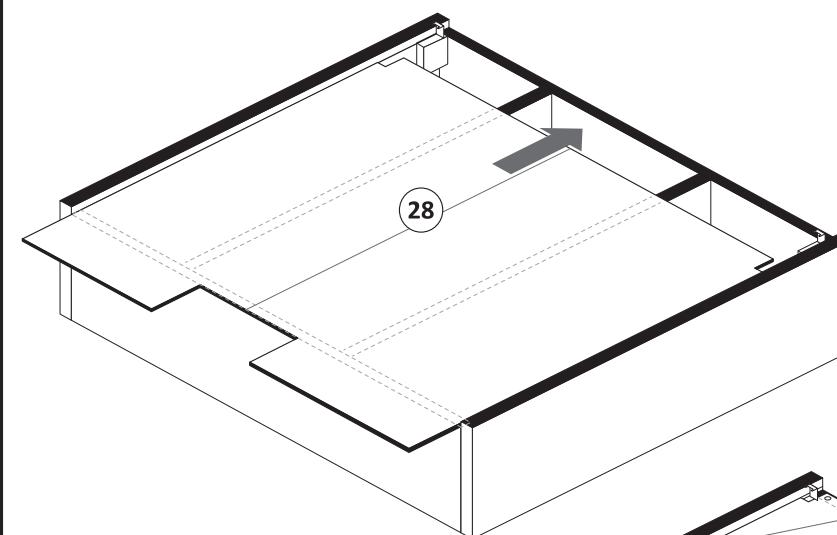

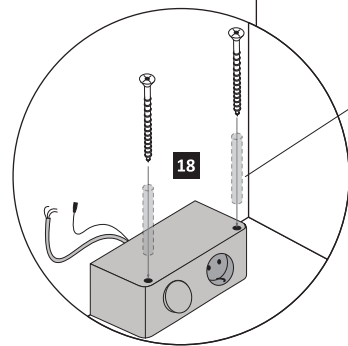
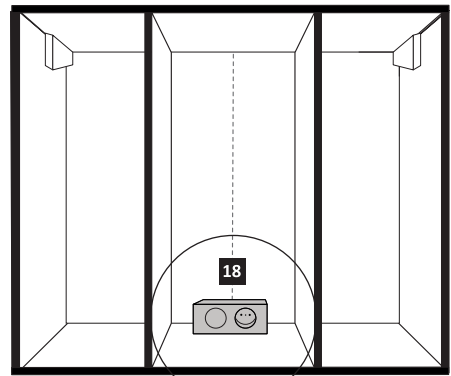
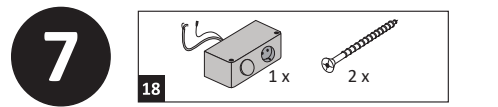

Achtung !!
Die Distanzhülsen sind optional im Lieferumfang.
Nur bei Bedarf nutzen.

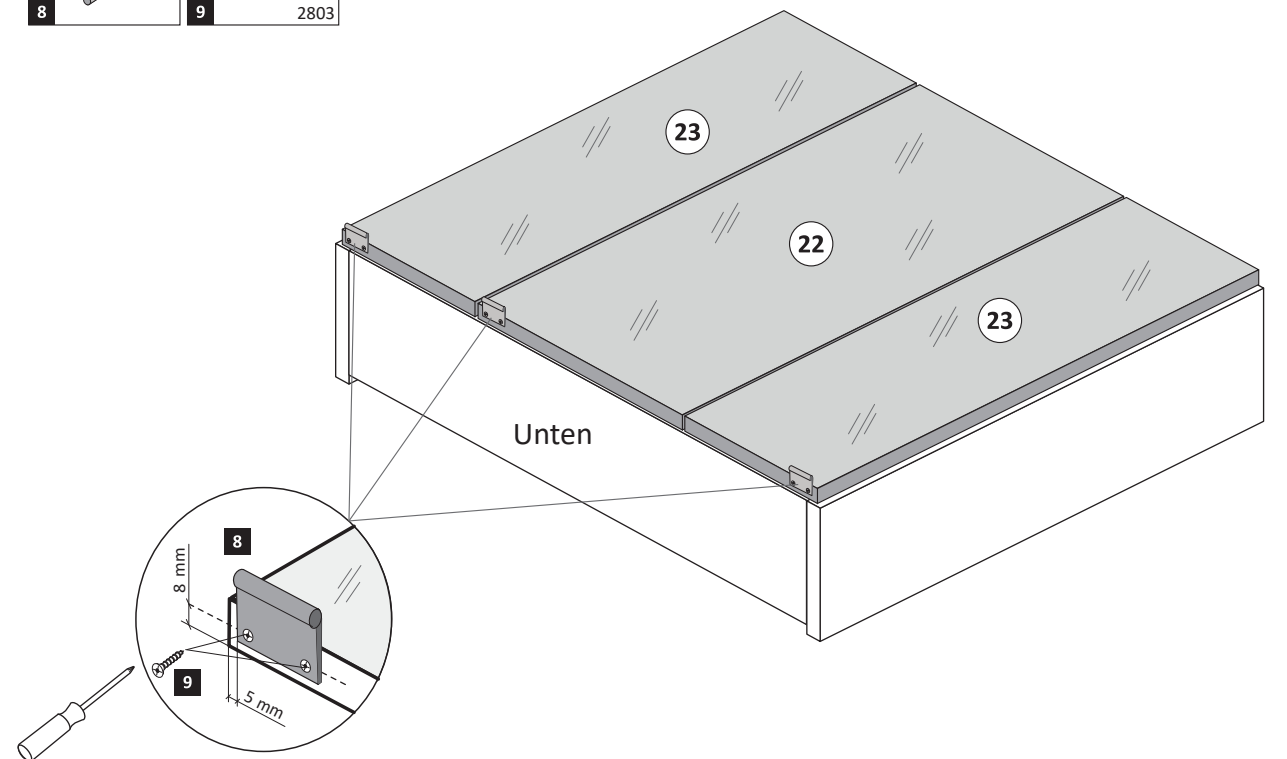
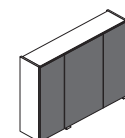
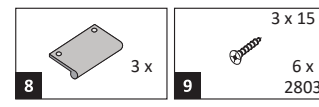
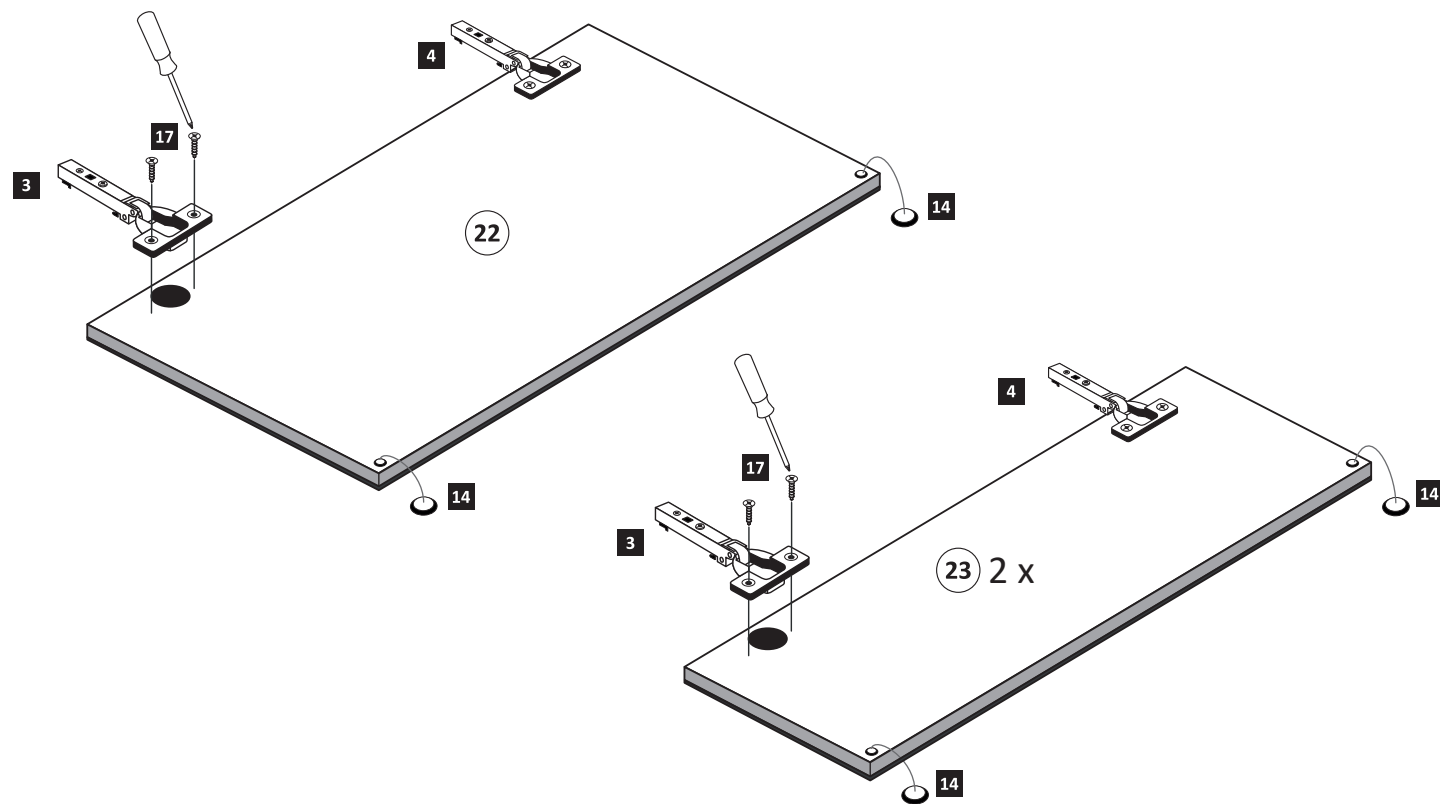
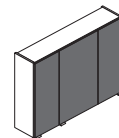
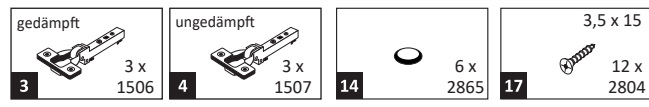
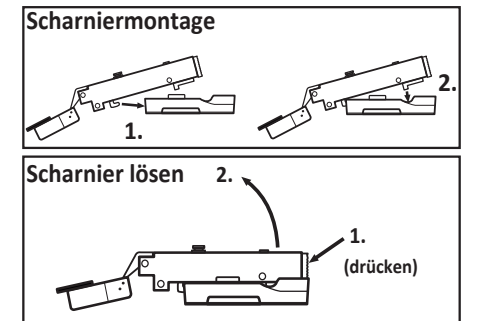
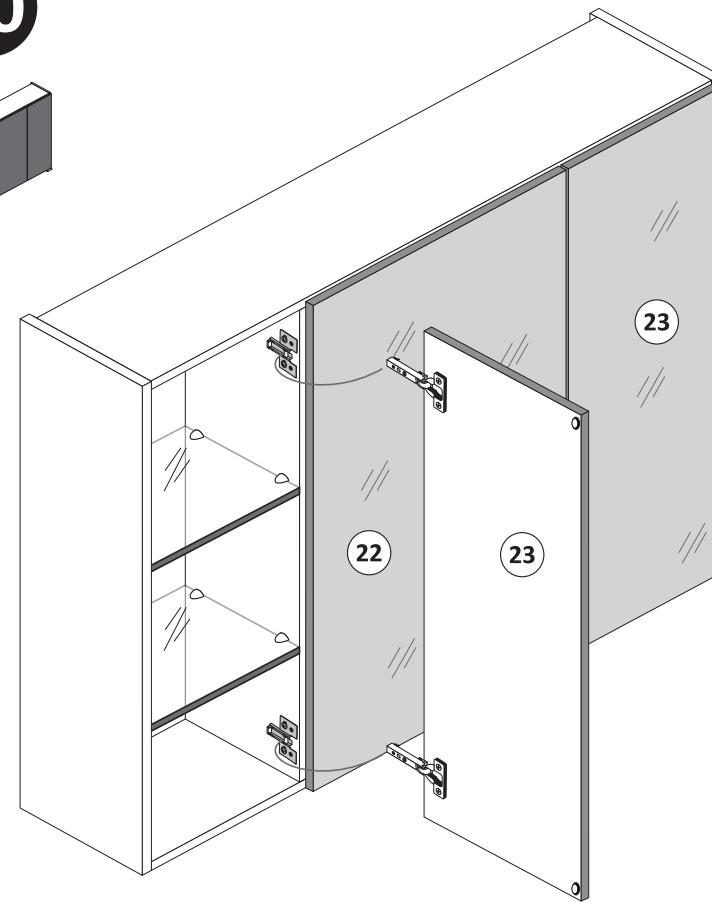
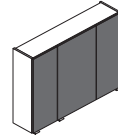
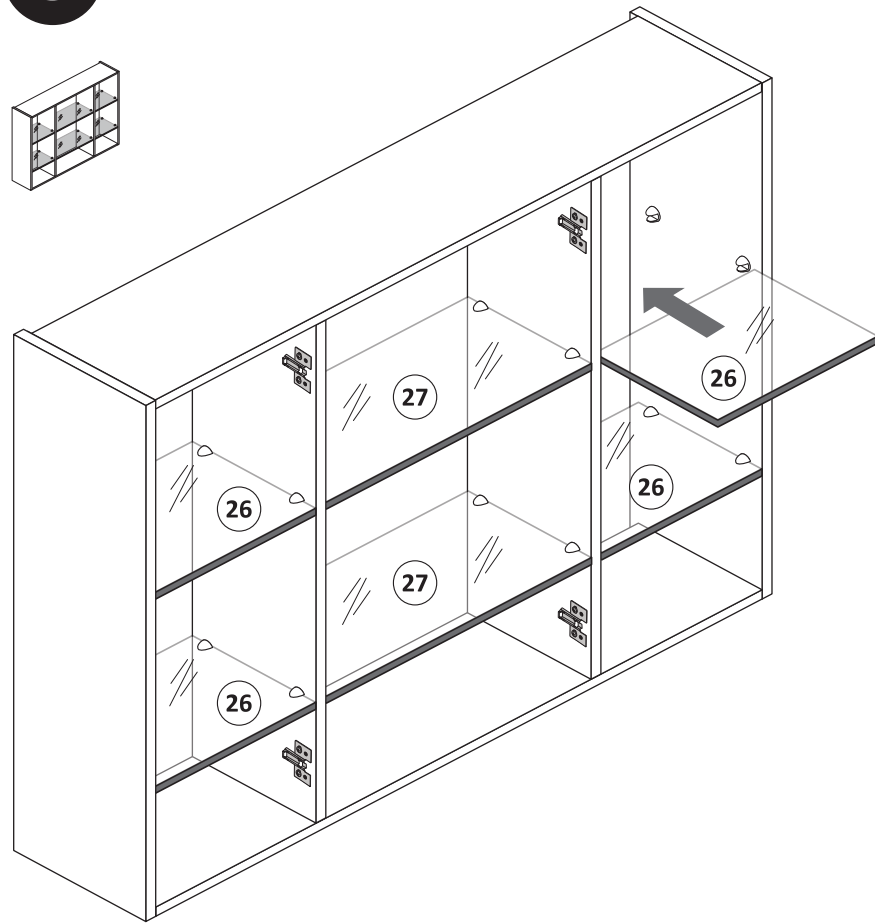
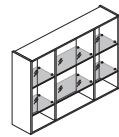

12

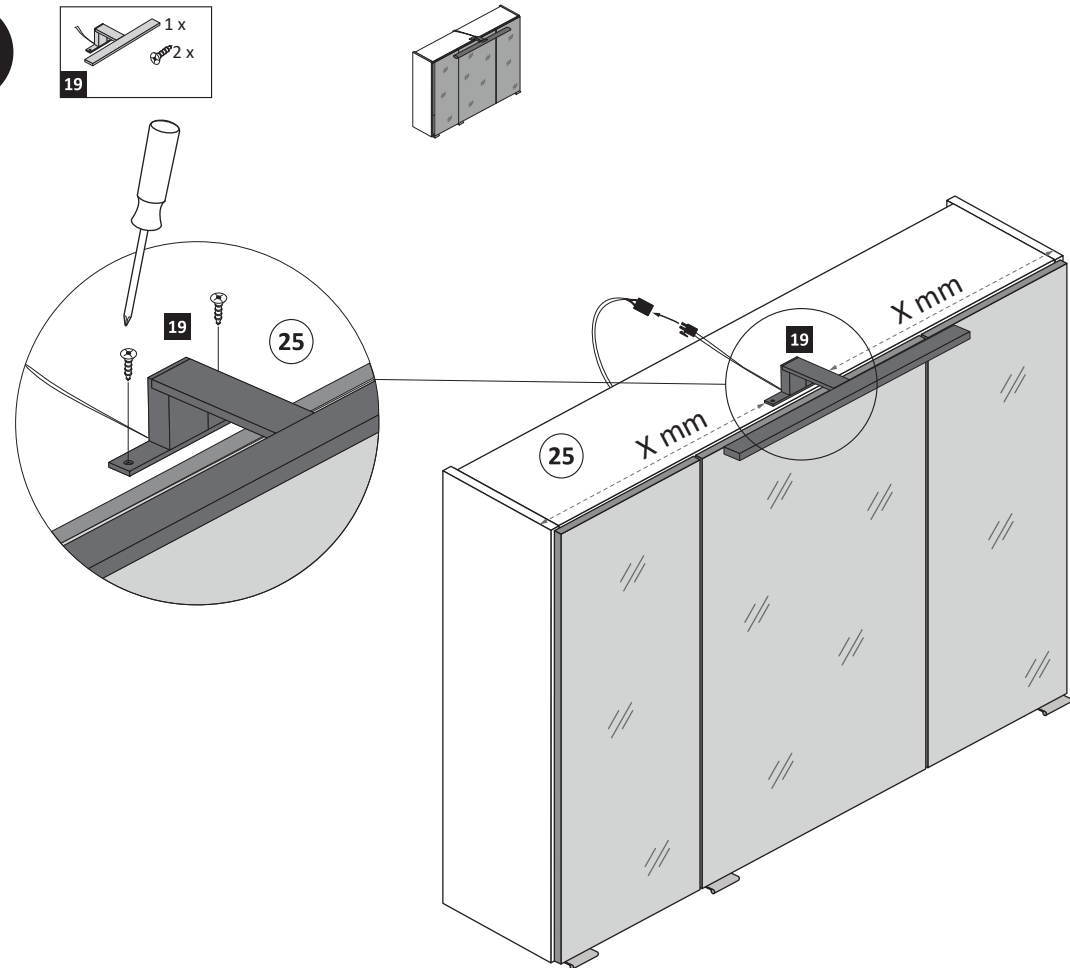

13

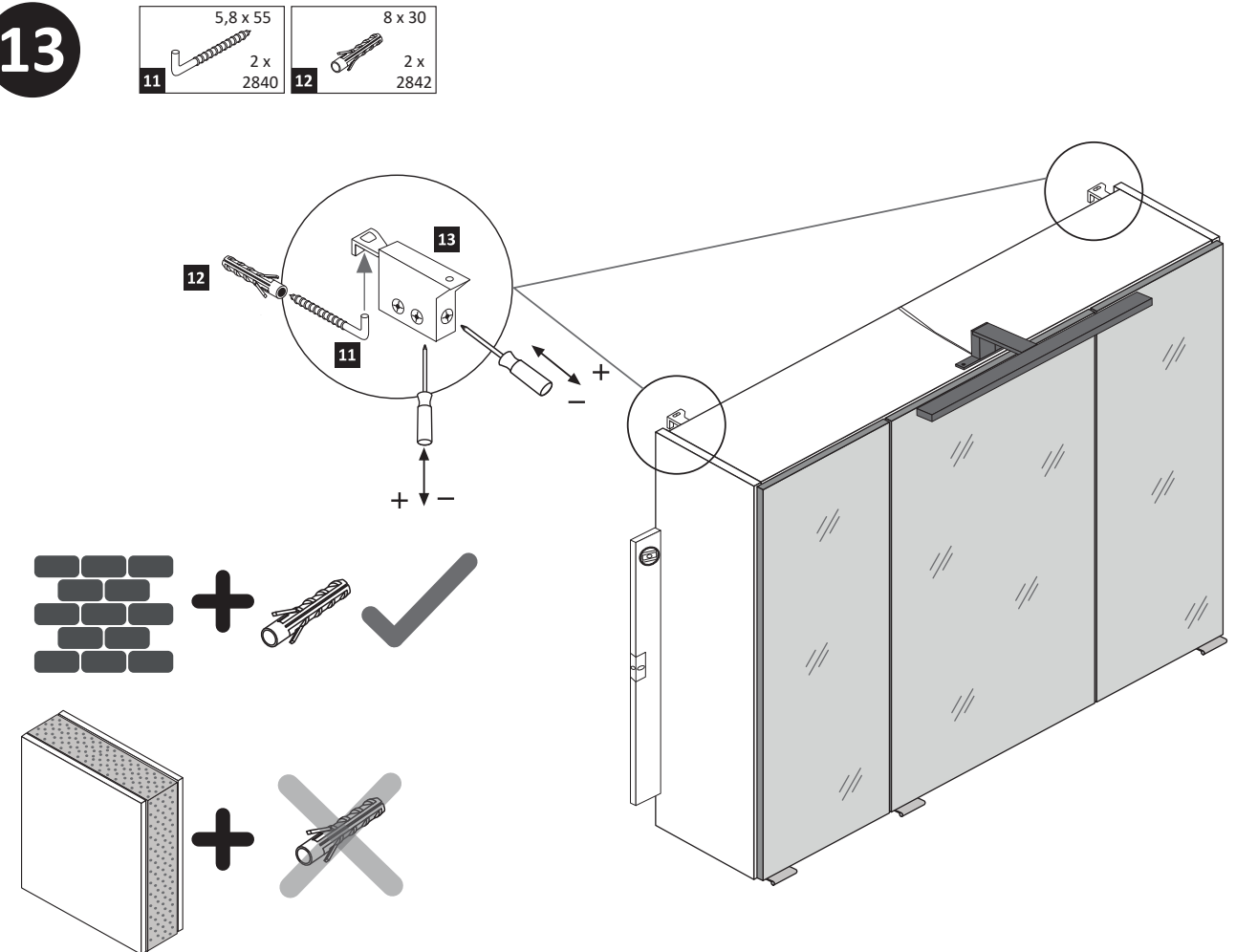

14

3,5 x 15
12 x 2804
17

1. Türen einstellen.

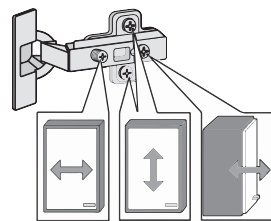

Achtung !!
Aus Sicherheitsgründen ist die Montage der Sicherungsschrauben zwingend notwendig. Nachdem montieren der Sicherungsschrauben ist die Höheneinstellung der Türen nicht mehr möglich!



2. Sicherungsschrauben montieren.

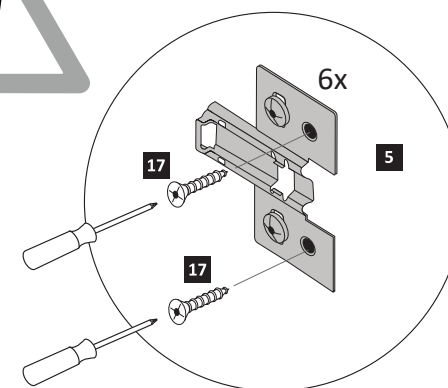
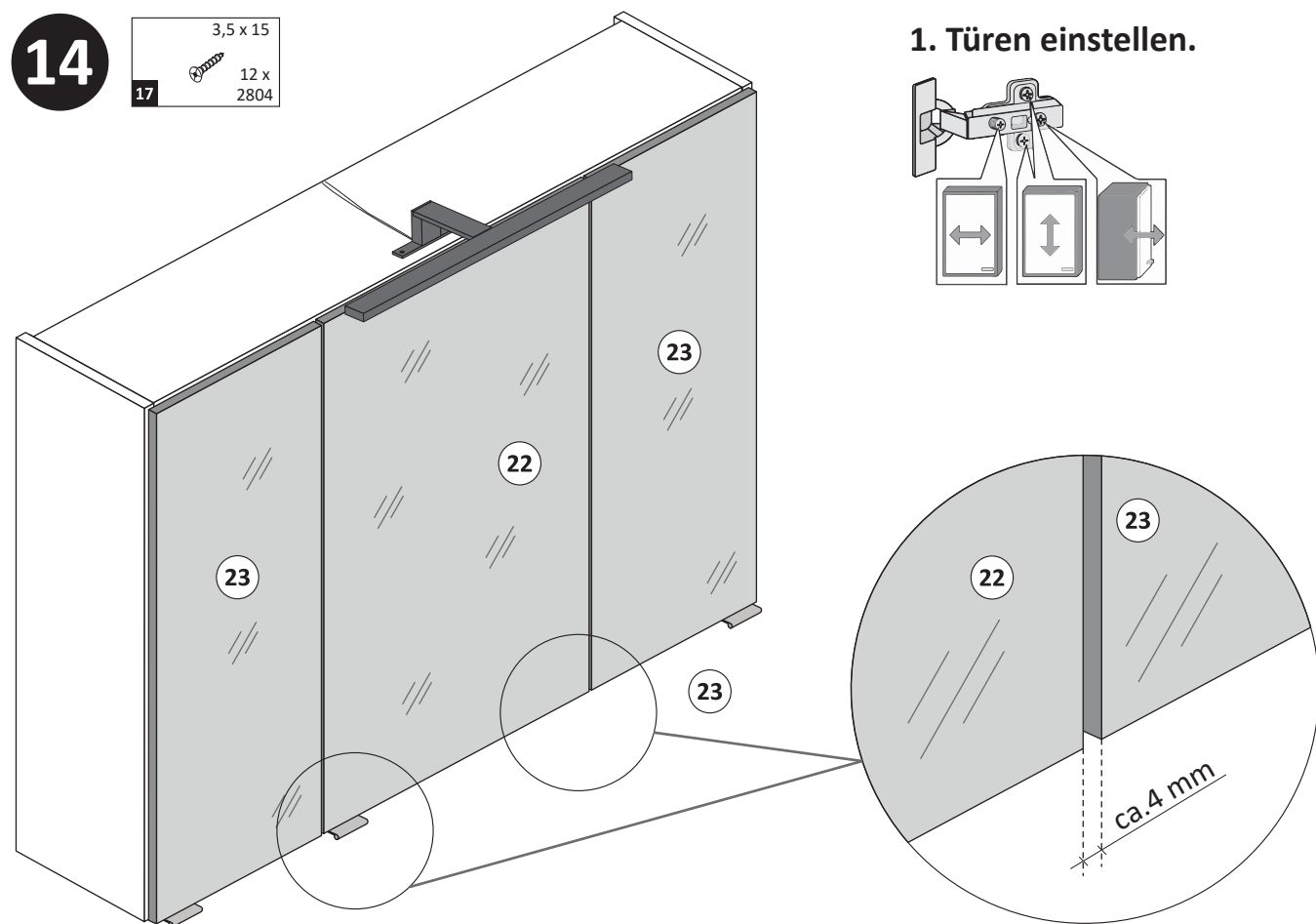



88085.532

1 4 x 2802	2 4 x 2801	gedämpft 3 x 1506	ungedämpft 3 x 1507	6 x 1614
6 24 x 2819	7 25 x 2862	8 3 x	3 x 15 6 x 2803	4 x 30 4 x 2812
5,8 x 55 2 x 2840	8 x 30 2 x 2842	13 2 x 2843	6 x 2865	8 x 30 16 x 2861
Leim 1 x 2863	3,5 x 15 26 x 2804	18 1 x 2 x	19 1 x 2 x	

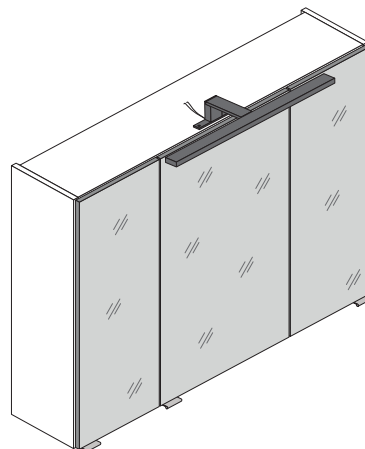
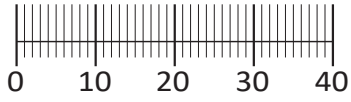
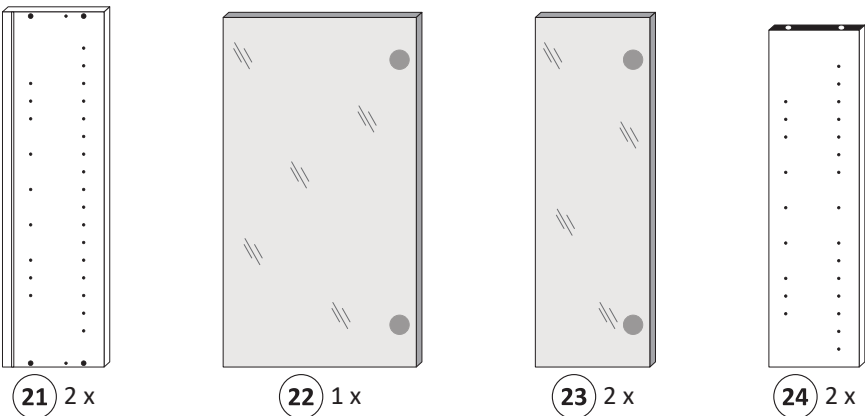

3D-Effekt

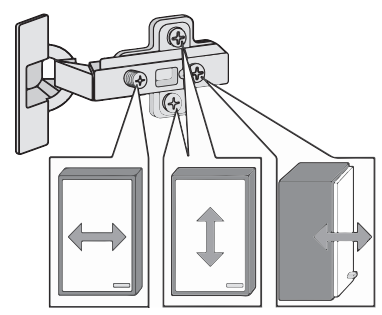
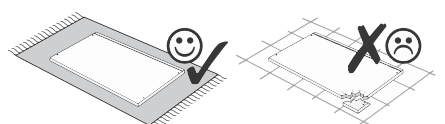
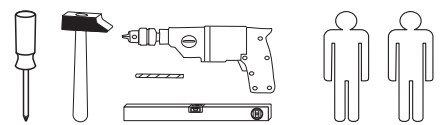
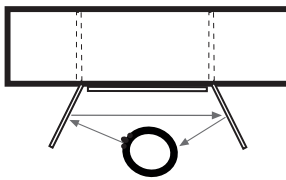

Held Möbel GmbH
Vogelparadies 9
32457 Porta Westfalica

Mail:
info@held-moebel.de



Diese Aufbauanleitung muss bis zum Ende der Nutzungszeit ihres Produktes sorgfältig aufbewahrt werden! Im Rahmen des Produkthaftungsgesetzes müssen Sie die Herstellerkennzeichnung aufbewahren. Zusätzlich kann Ihnen die Aufbauanleitung bei Ersatzteilbestellungen helfen, Bauteile und Beschläge eindeutig zu identifizieren.

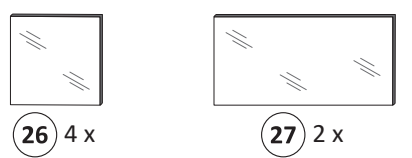
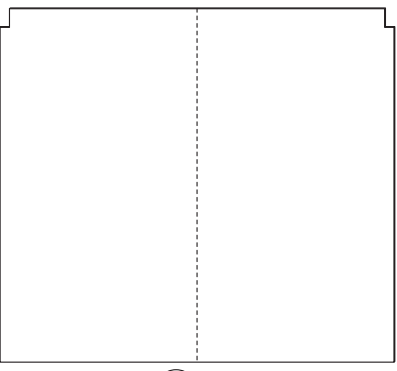
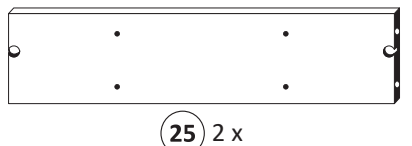

1

1 4 x 2802	6 8 x 2819	10 4 x 30 4 x 2812	13 2 x 2843
------------------	------------------	-----------------------------	-------------------

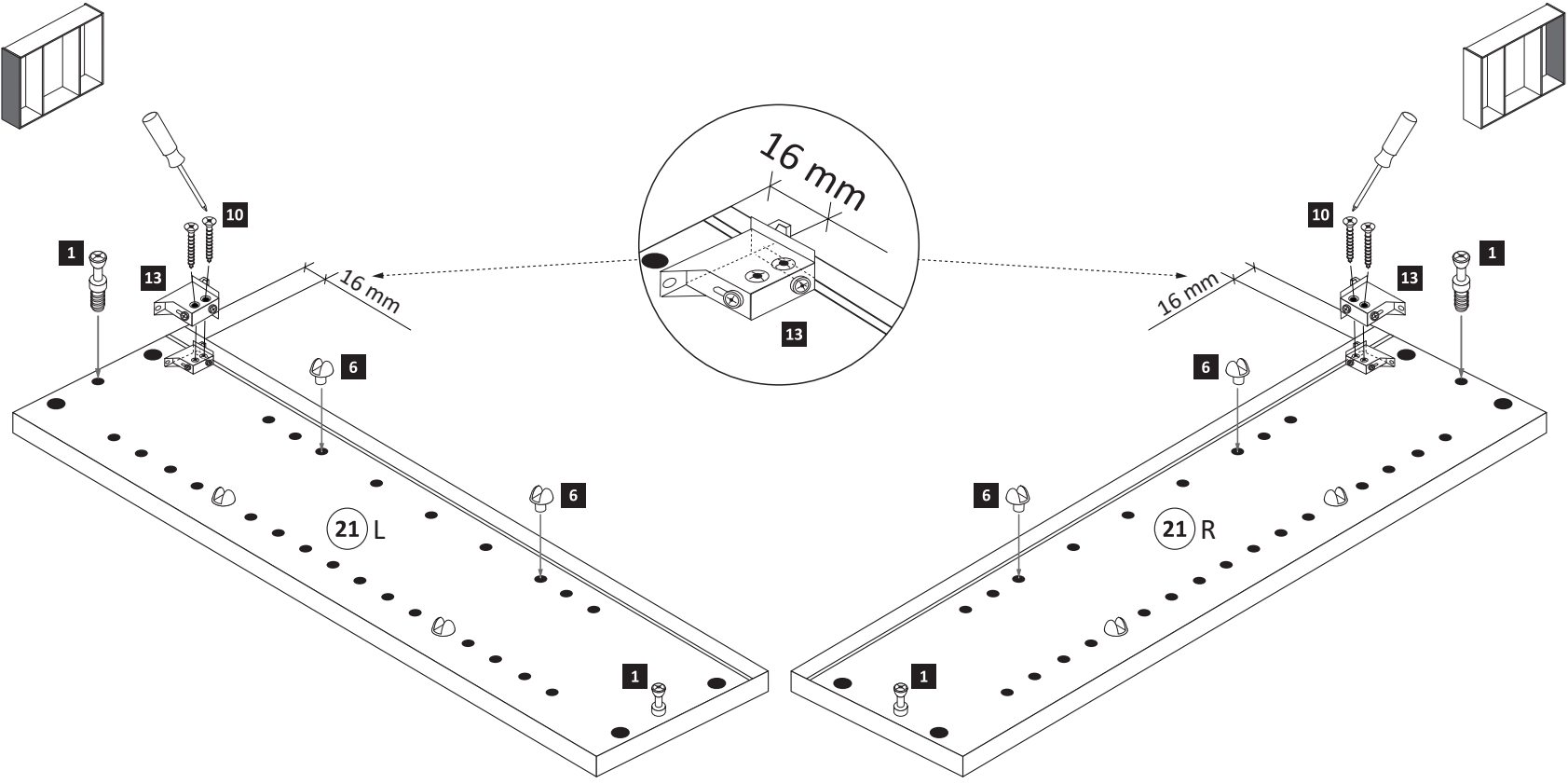

2

5 6 x 1614	6 16 x 2819	15 8 x 30 8 x 2861	16 Leim 1 x 2863
------------------	-------------------	-----------------------------	---------------------------

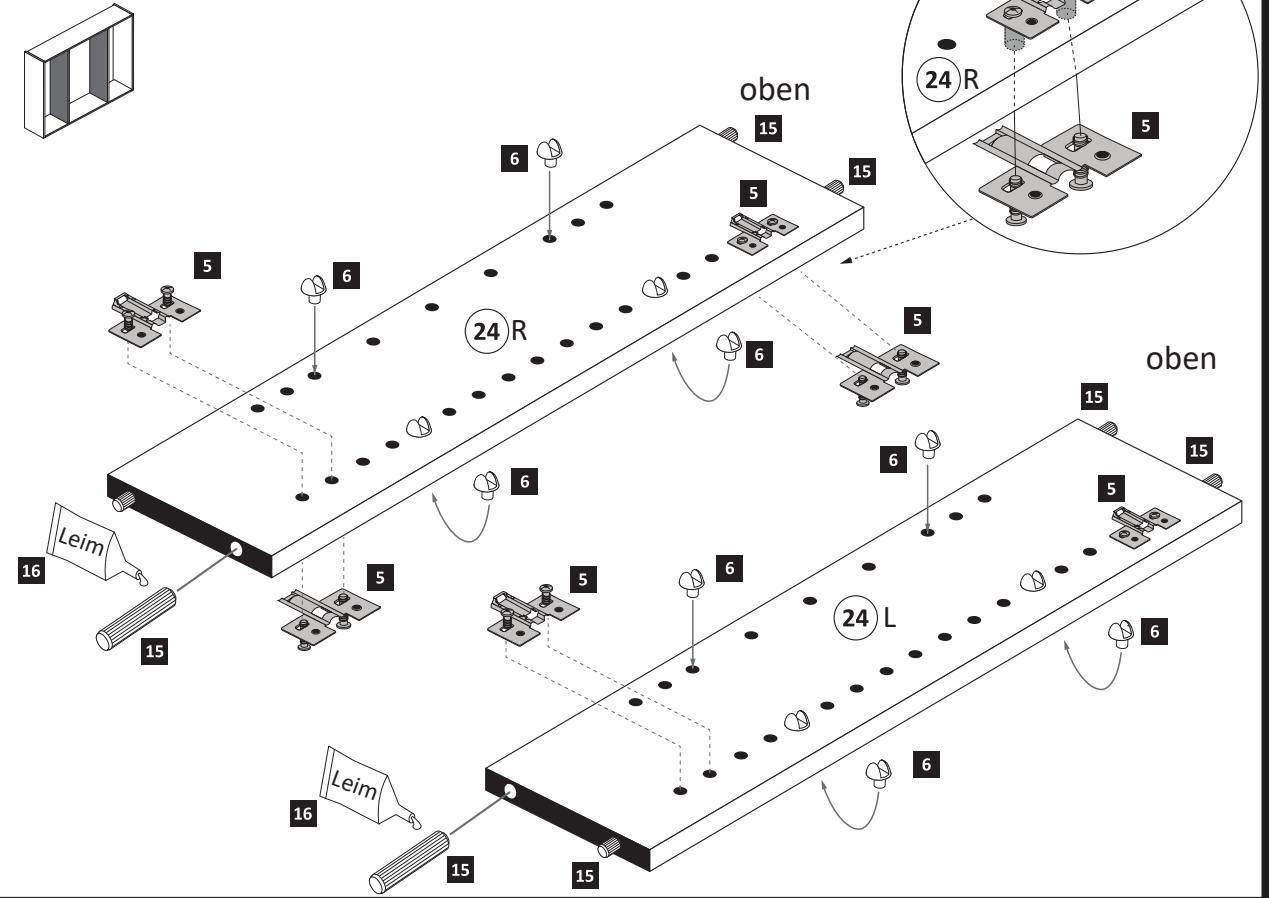

3

- 2 4 x 2801
- 15 8 x 30 8 x 2861
- 16 1 x 2863

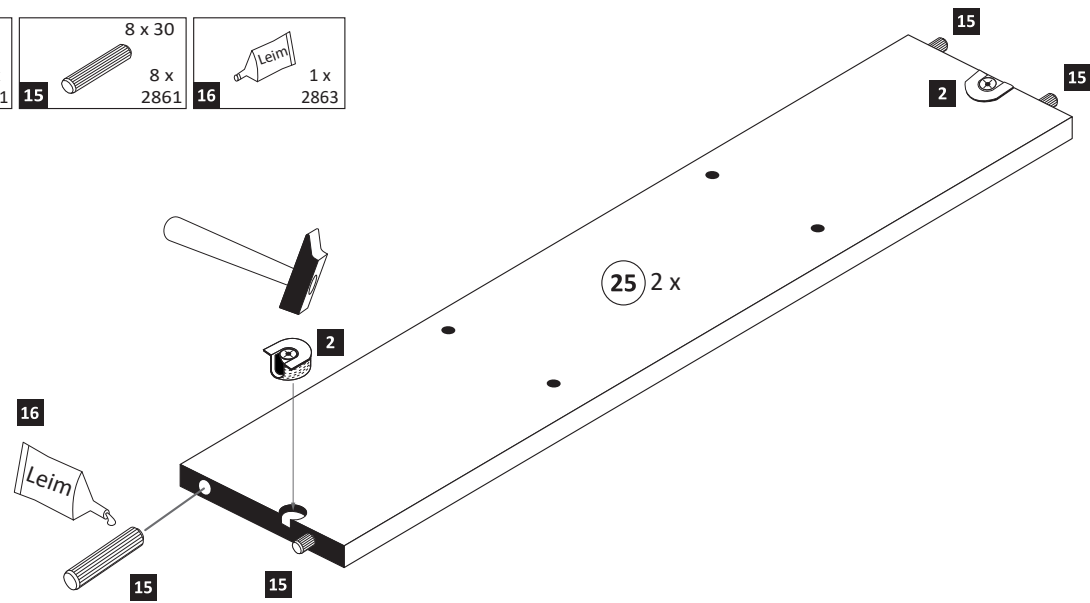

4

- 17 3,5 x 15 2 x 2804

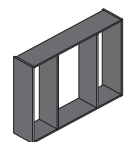

- 16 1 x 2863
 - D Leim
 - GB Glue
 - NL Lijm
 - PL Klej
 - TR Tutkal
 - F Colle
 - I Colla
- 20 min.

Ansicht von links

Ansicht von rechts

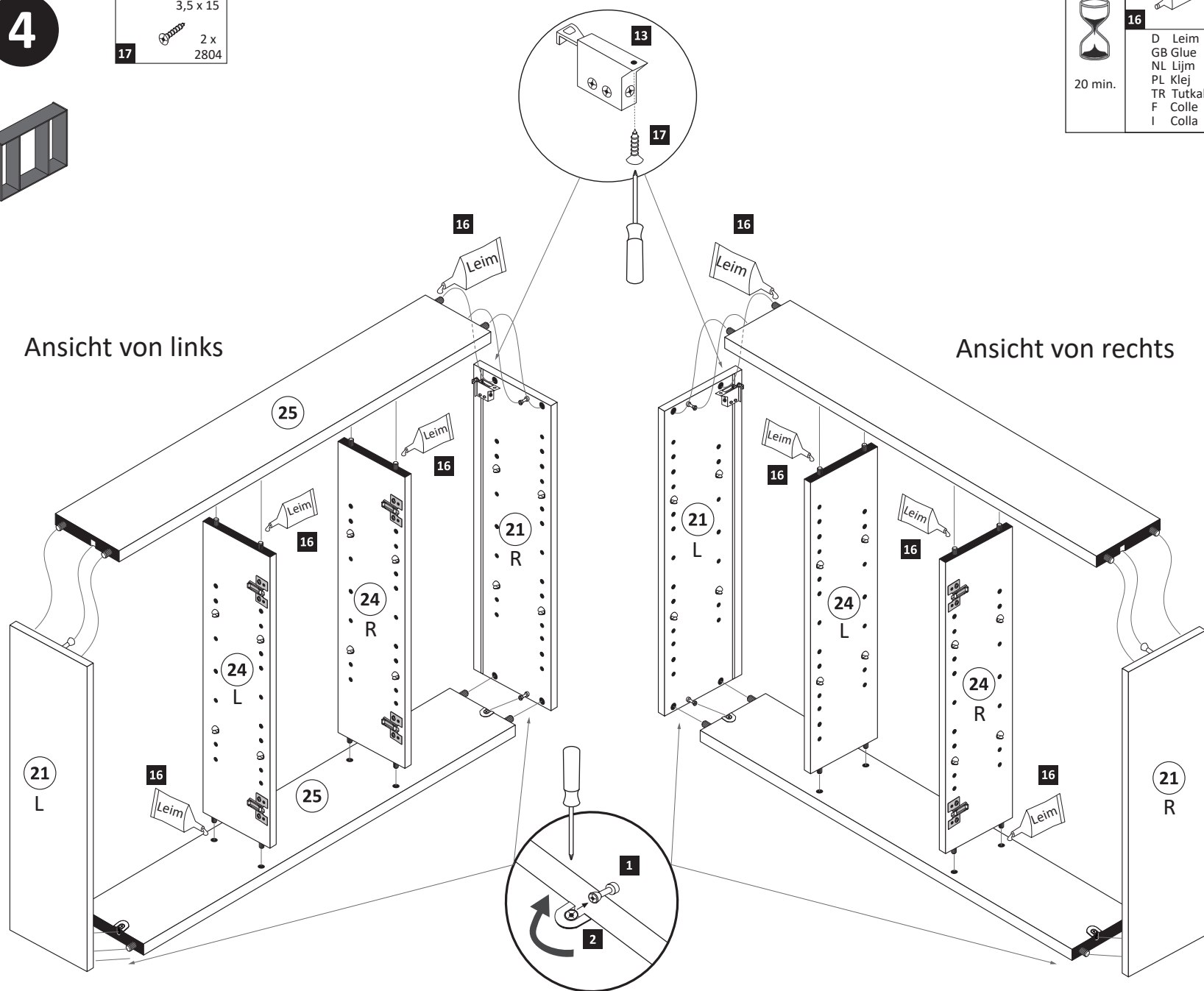

5

Bitte nur eine Variante auswählen und den entsprechenden Ausschnitt in einer Größe von maximal Trafobreite wie Trafohöhe - 10 mm aussägen. Trafomontage wird im Schritt 7 durchgeführt.

Variante 1: Trafomontage unten

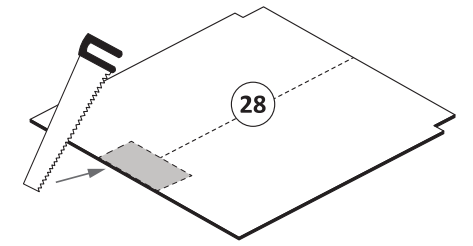
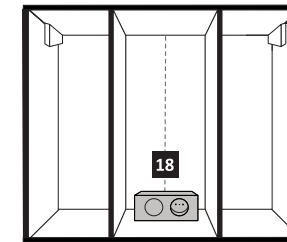

Variante 2: Trafomontage oben

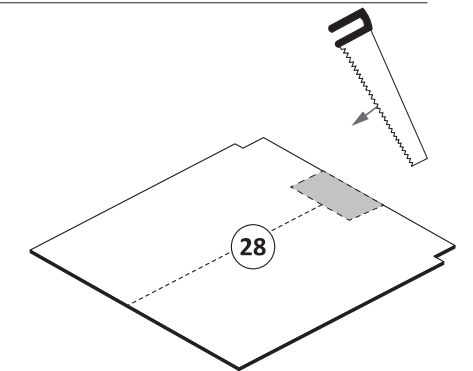
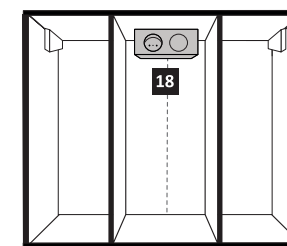

6

- 7 25 x 2862

ACHTUNG!
Folgende Montageschritte mit dem Beispiel „Trafomontage Variante unten links“!

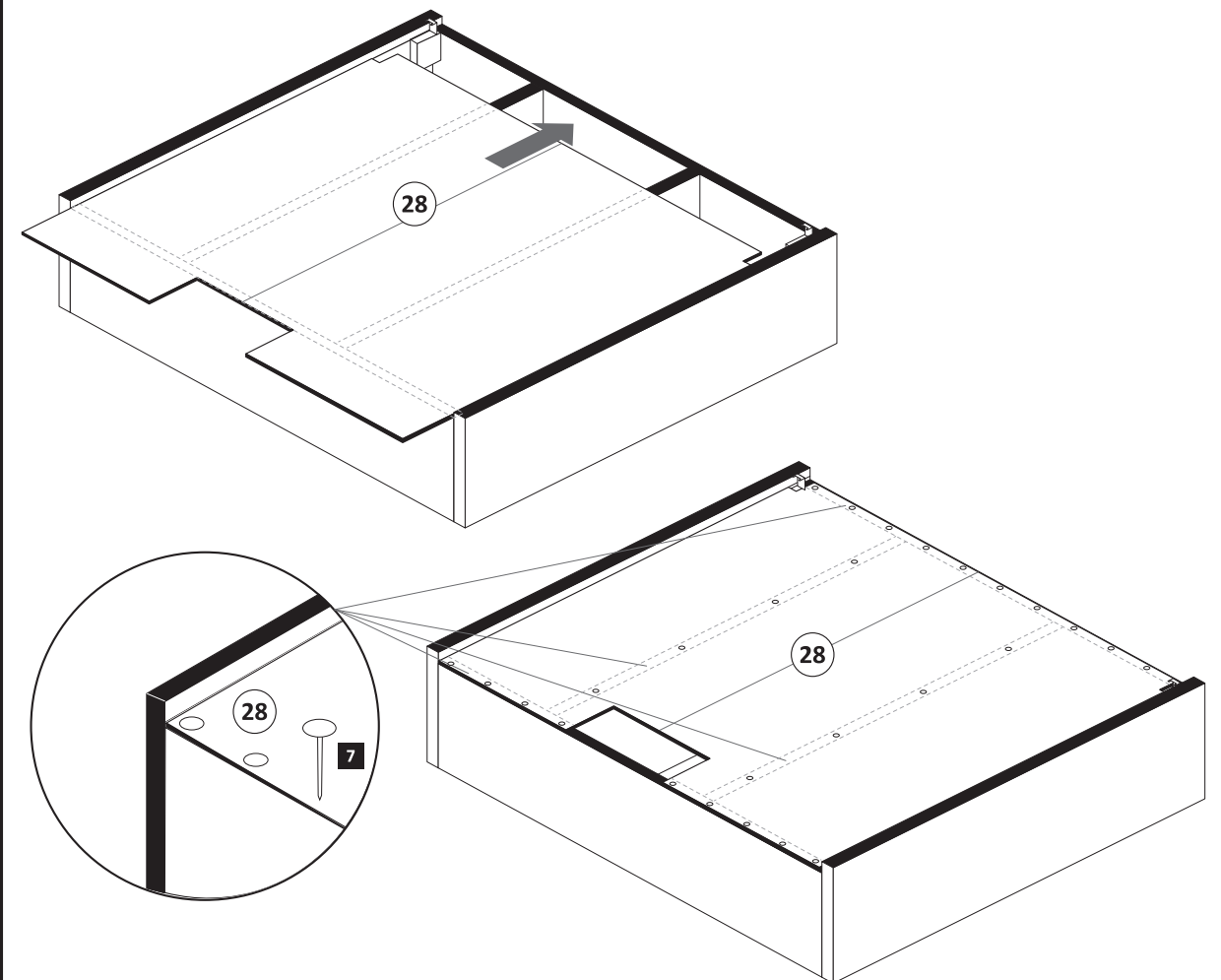

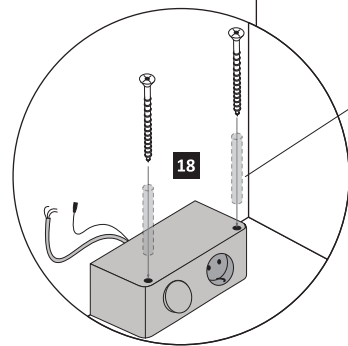
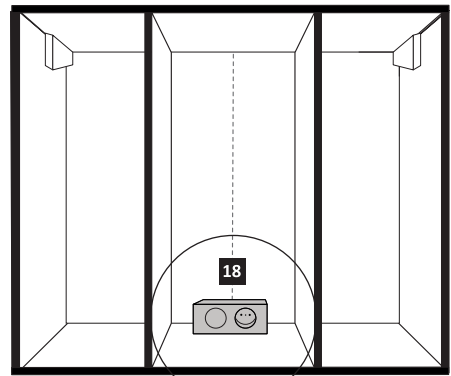
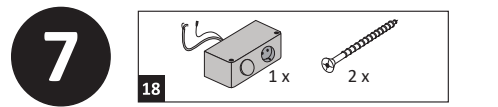

Achtung !!
Die Distanzhülsen sind optional im Lieferumfang.
Nur bei Bedarf nutzen.

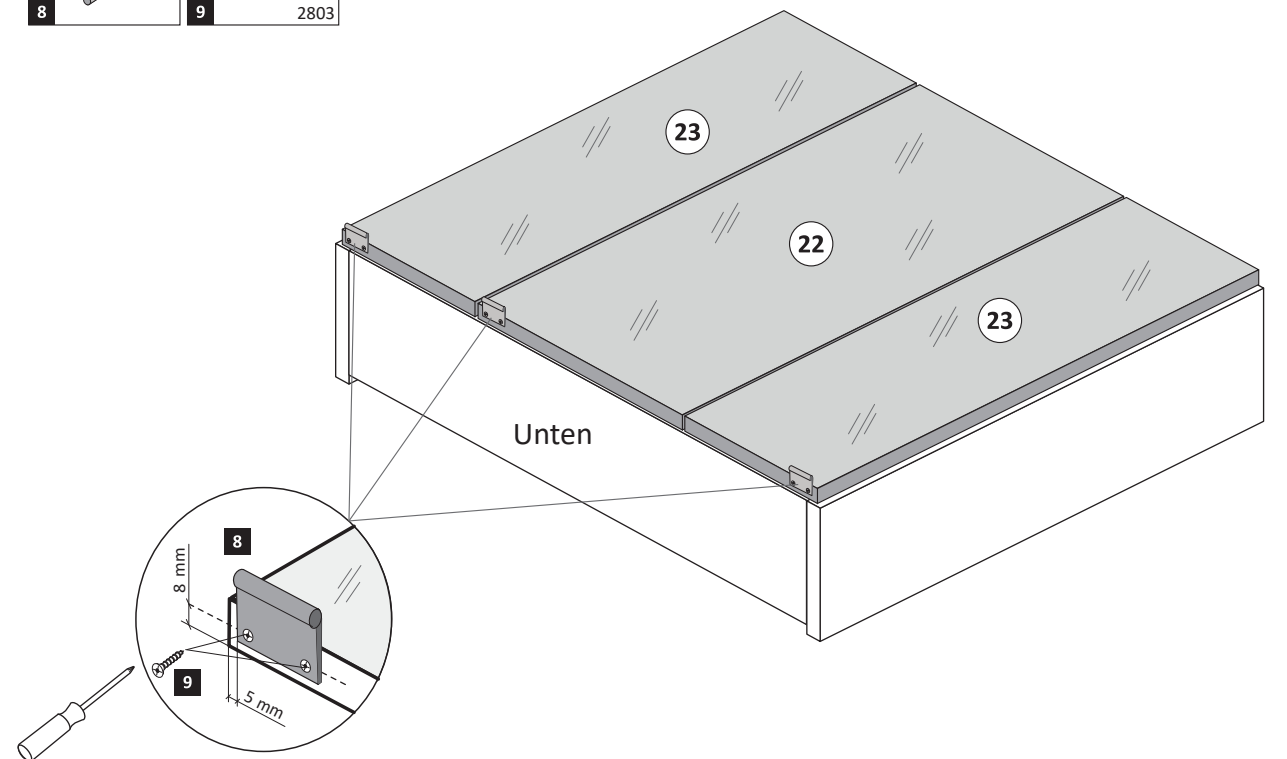
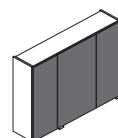
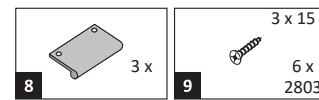
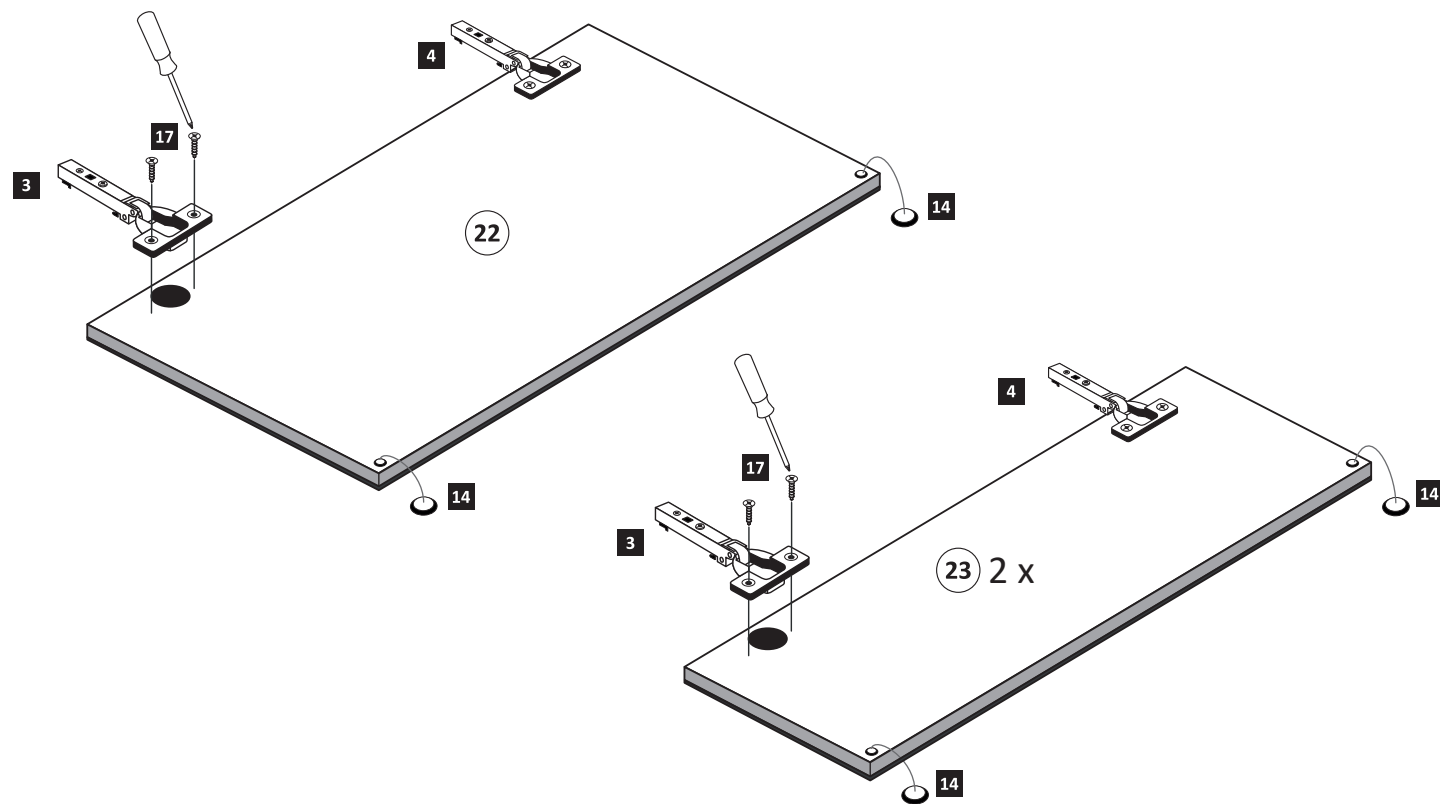
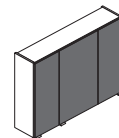
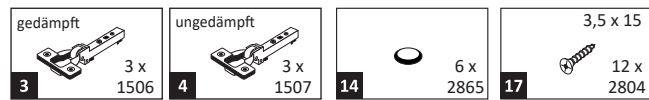
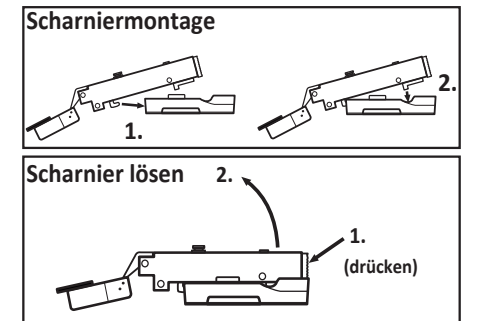
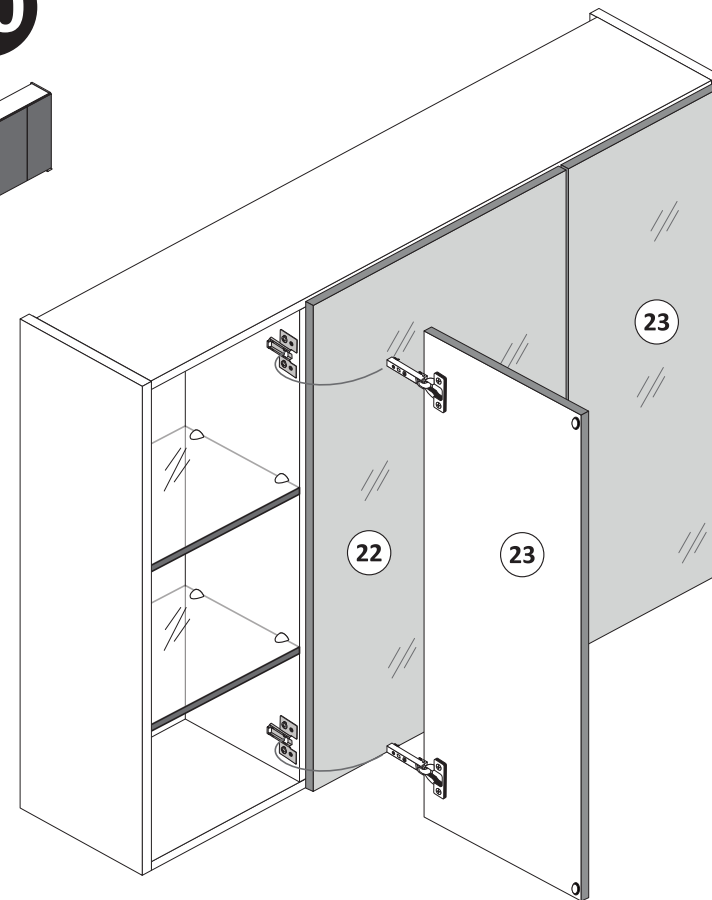
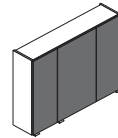
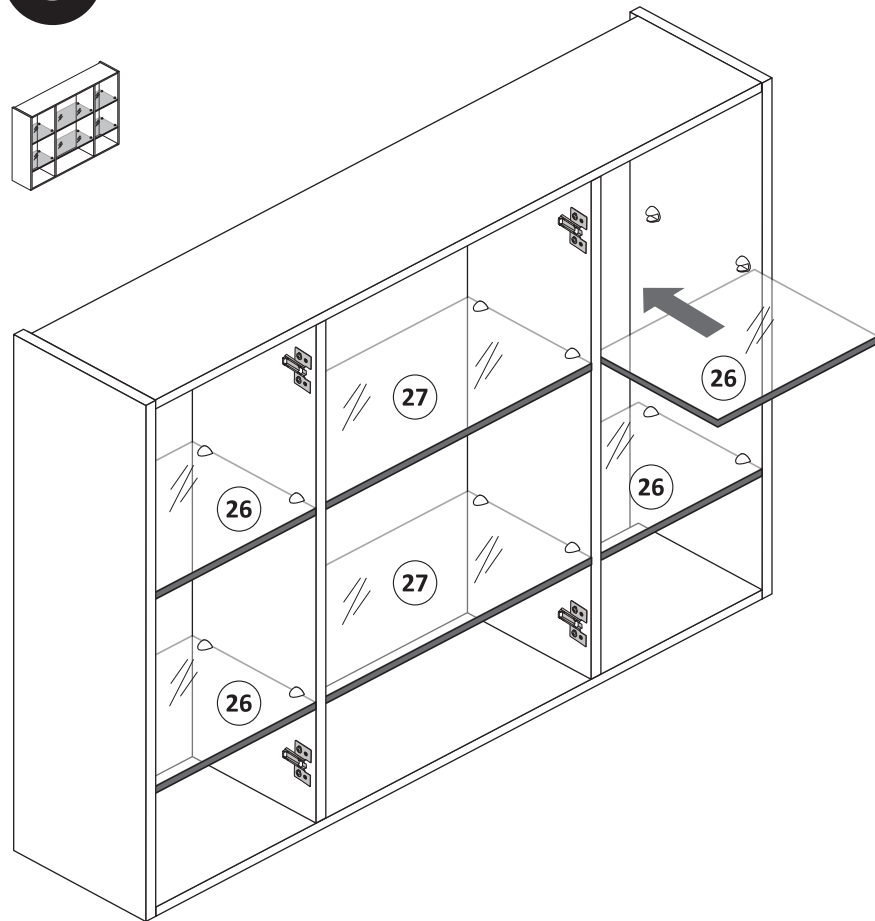
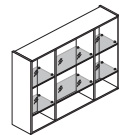

12

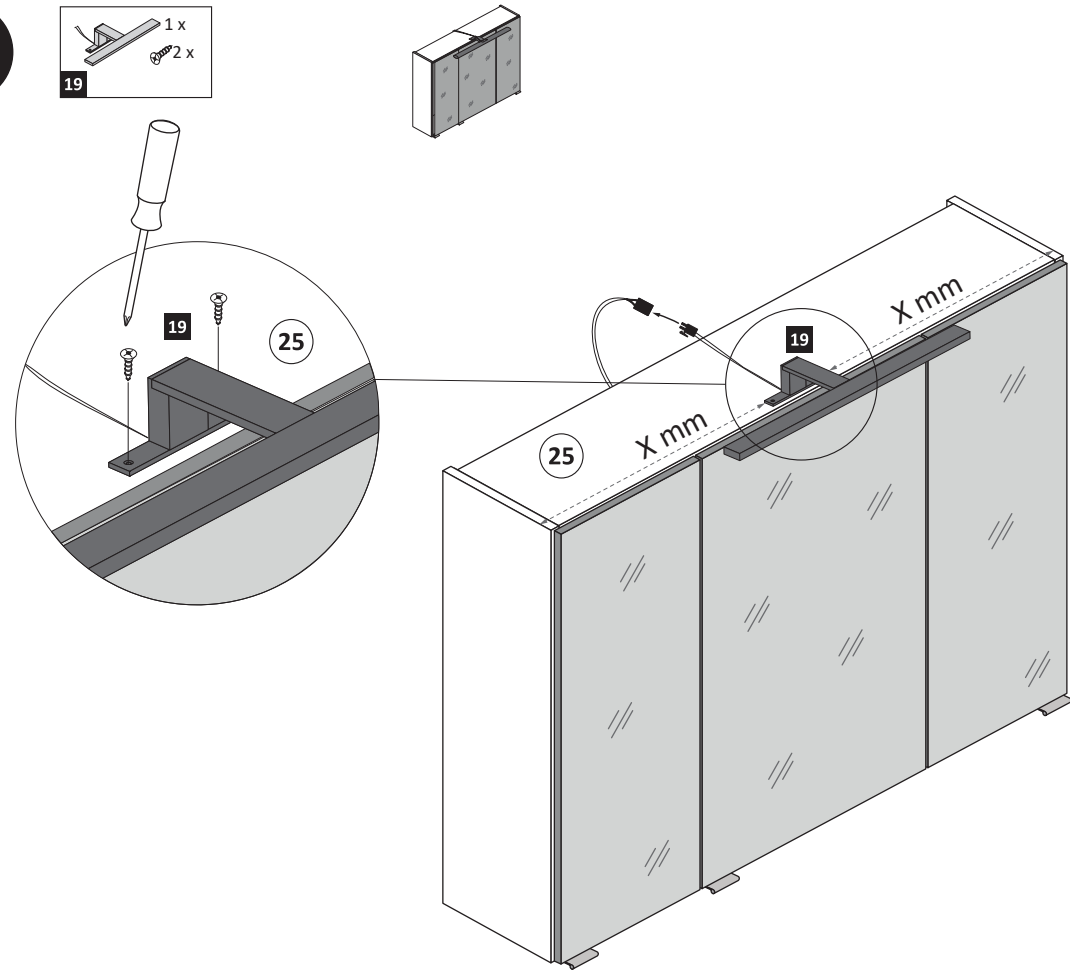

13

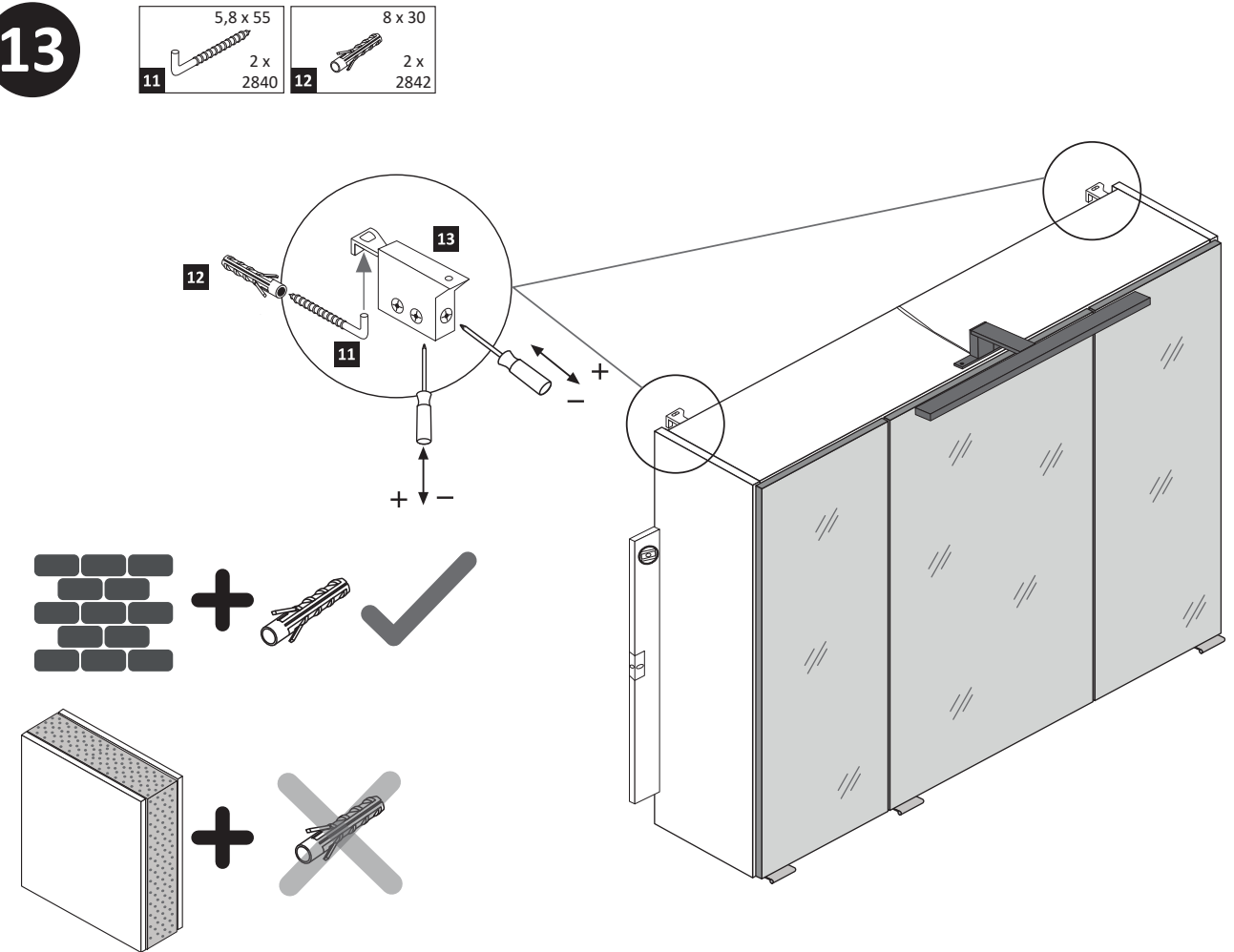

14

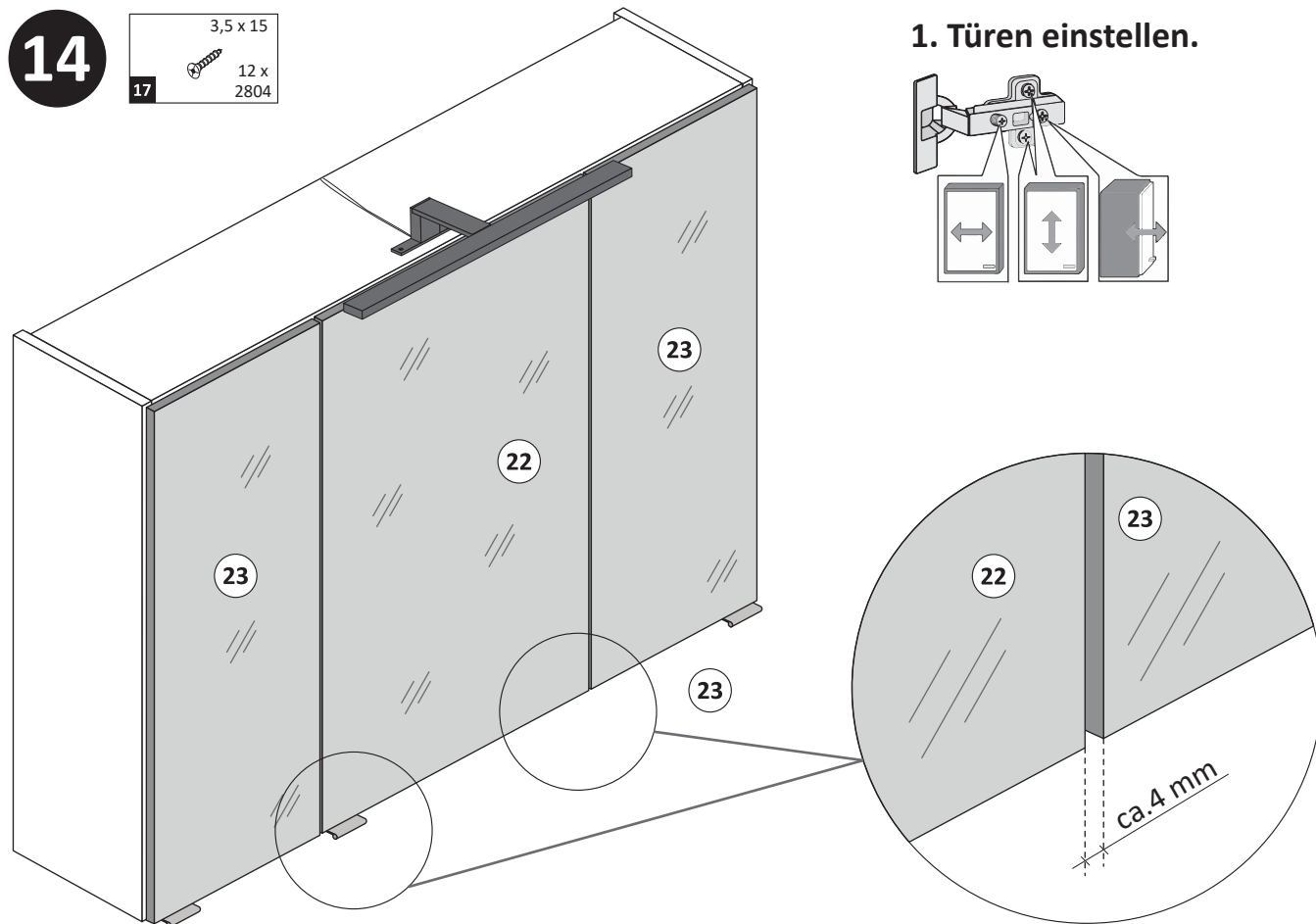

1. Türen einstellen.

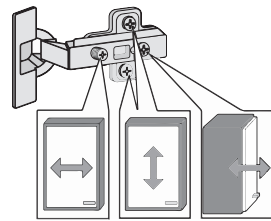

Achtung !!
Aus Sicherheitsgründen ist die Montage der Sicherungsschrauben zwingend notwendig. Nachdem montieren der Sicherungsschrauben ist die Höheneinstellung der Türen nicht mehr möglich!

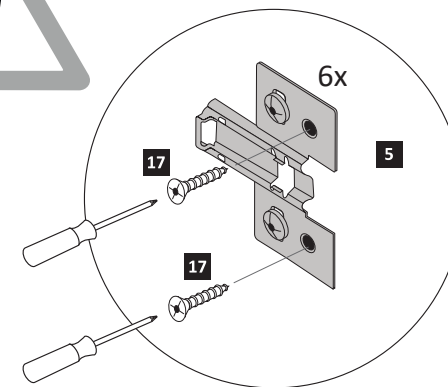

2. Sicherungsschrauben montieren.

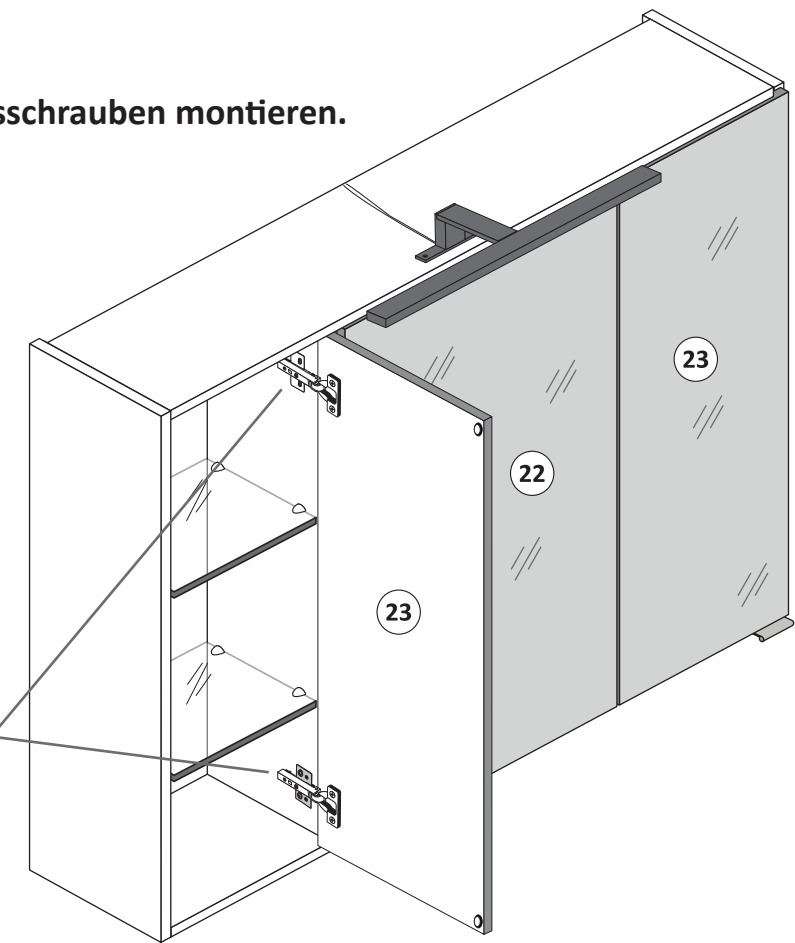



88085.532

1 4 x 2802	2 4 x 2801	gedämpft 3 x 1506	ungedämpft 3 x 1507	6 x 1614
6 24 x 2819	7 25 x 2862	8 3 x	3 x 15 6 x 2803	4 x 30 4 x 2812
5,8 x 55 2 x 2840	8 x 30 2 x 2842	13 2 x 2843	6 x 2865	8 x 30 16 x 2861
Leim 1 x 2863	3,5 x 15 26 x 2804	18 1 x 2 x	19 1 x 2 x	

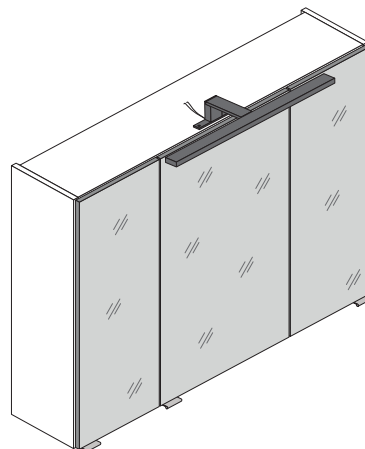
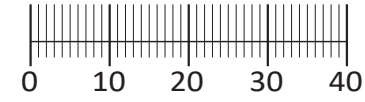
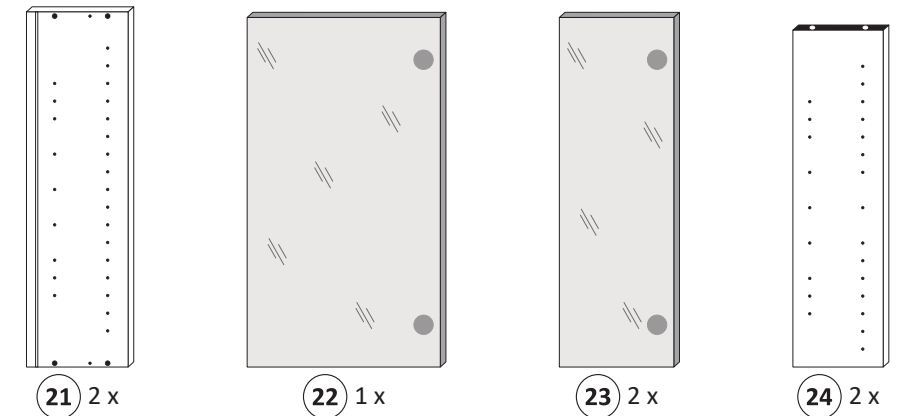

3D-Effekt

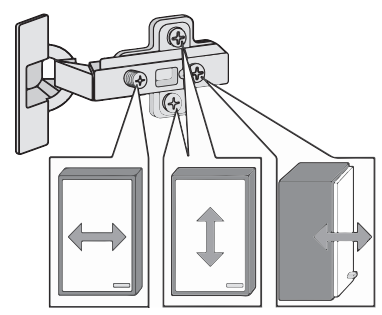
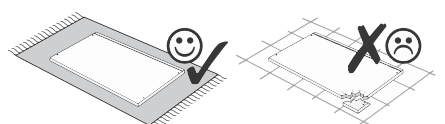
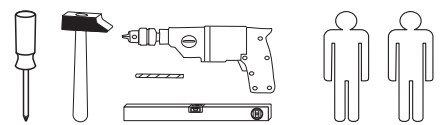
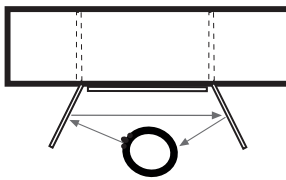

Held Möbel GmbH
Vogelparadies 9
32457 Porta Westfalica

Mail:
info@held-moebel.de



Diese Aufbauanleitung muss bis zum Ende der Nutzungszeit ihres Produktes sorgfältig aufbewahrt werden! Im Rahmen des Produkthaftungsgesetzes müssen Sie die Herstellerkennzeichnung aufbewahren. Zusätzlich kann Ihnen die Aufbauanleitung bei Ersatzteilbestellungen helfen, Bauteile und Beschläge eindeutig zu identifizieren.

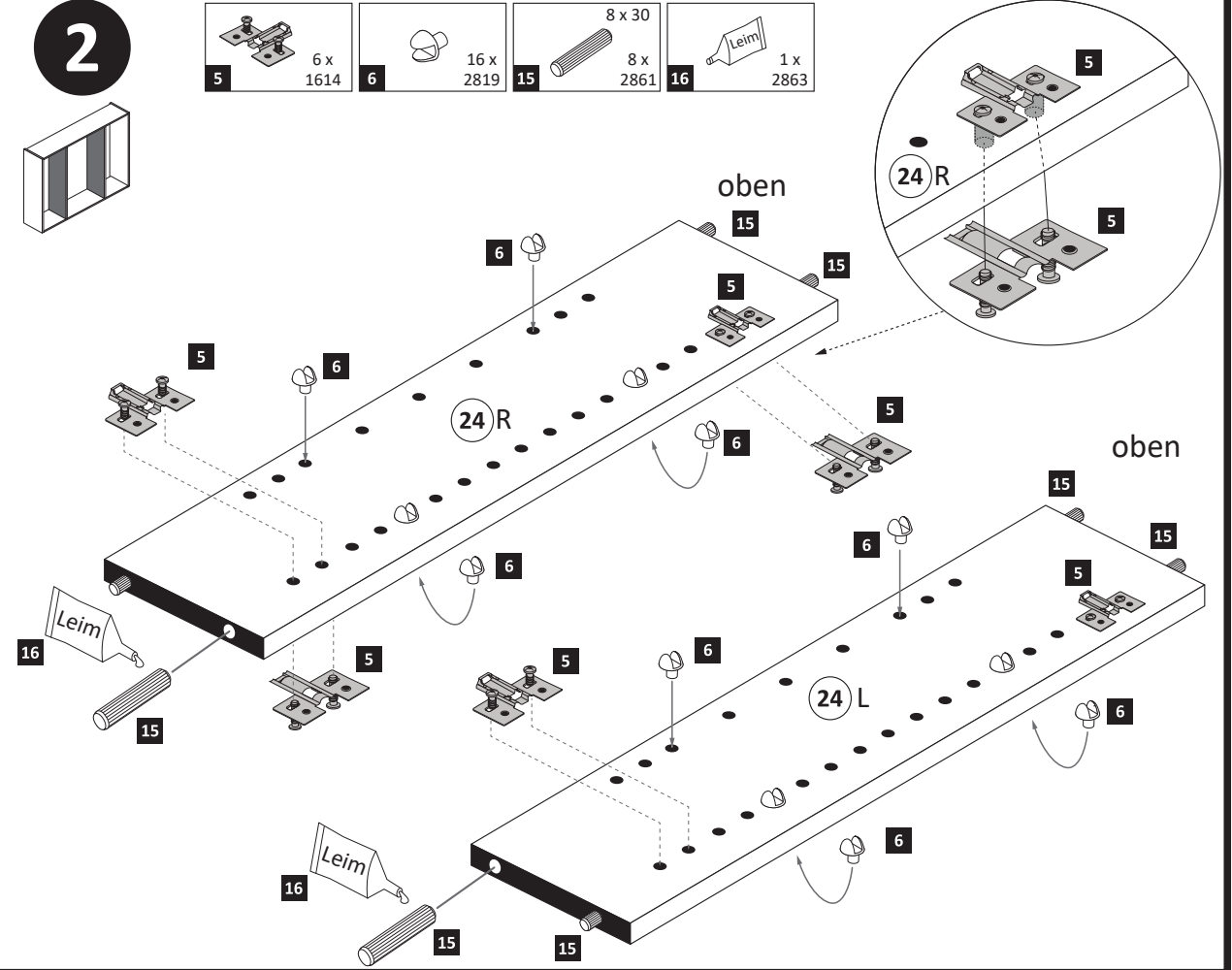
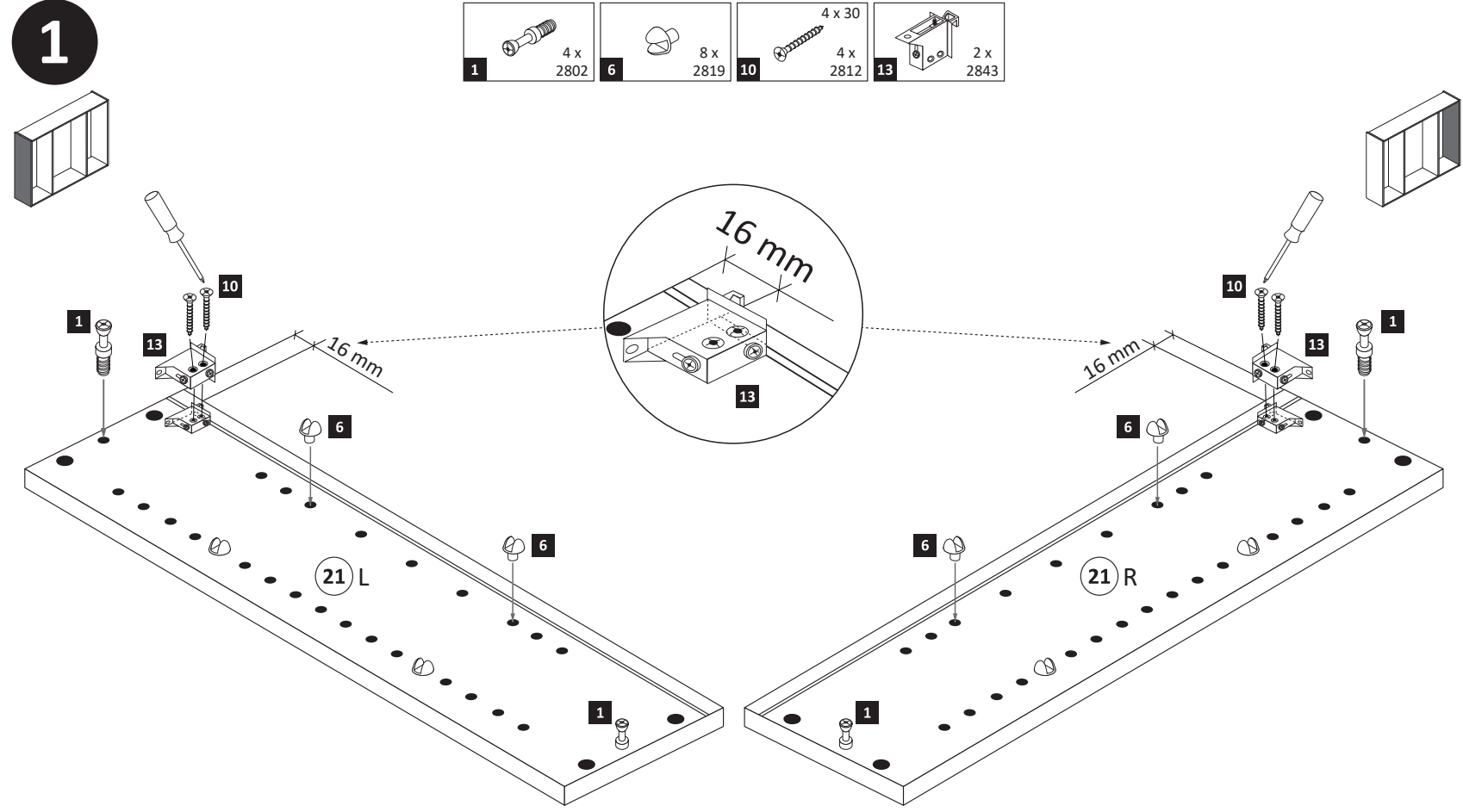
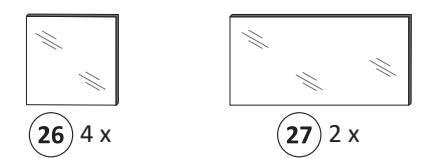
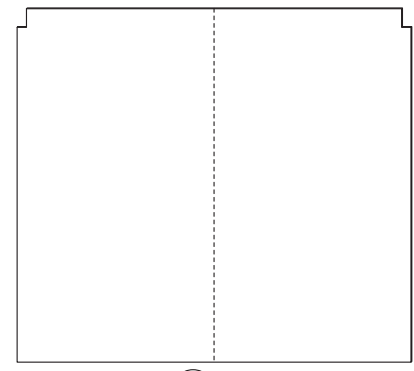
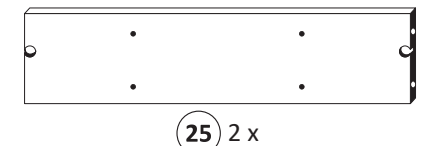

3

- 2 4 x 2801
- 15 8 x 30 8 x 2861
- 16 1 x 2863

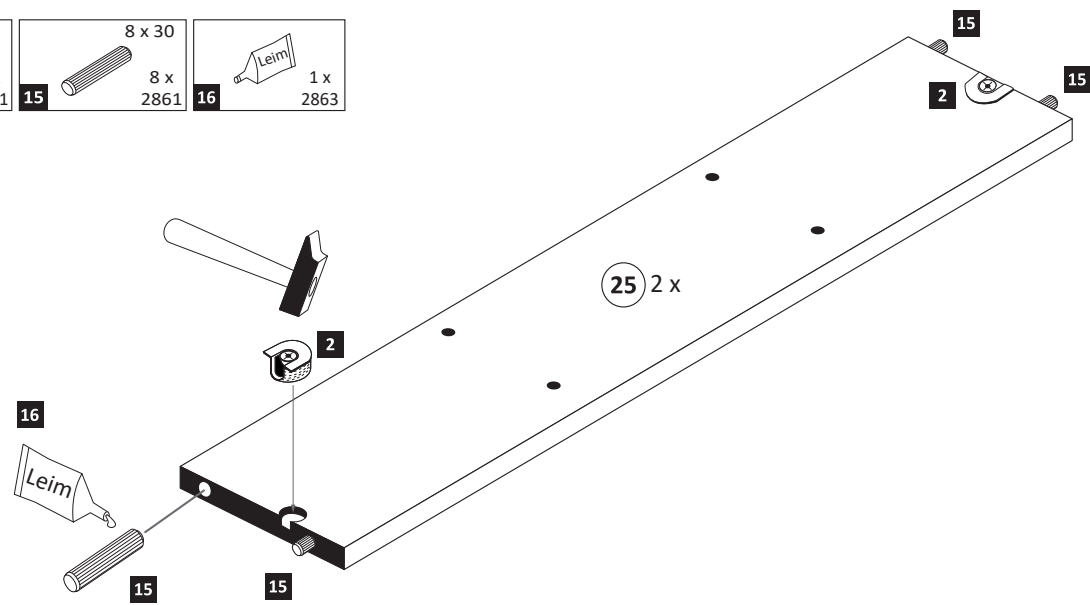

4

- 17 3,5 x 15 2 x 2804

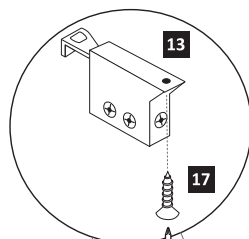
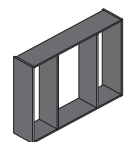

- 16 1 x 2863
- D Leim
 GB Glue
 NL Lijm
 PL Klej
 TR Tutkal
 F Colle
 I Colla
- 20 min.

Ansicht von links

Ansicht von rechts

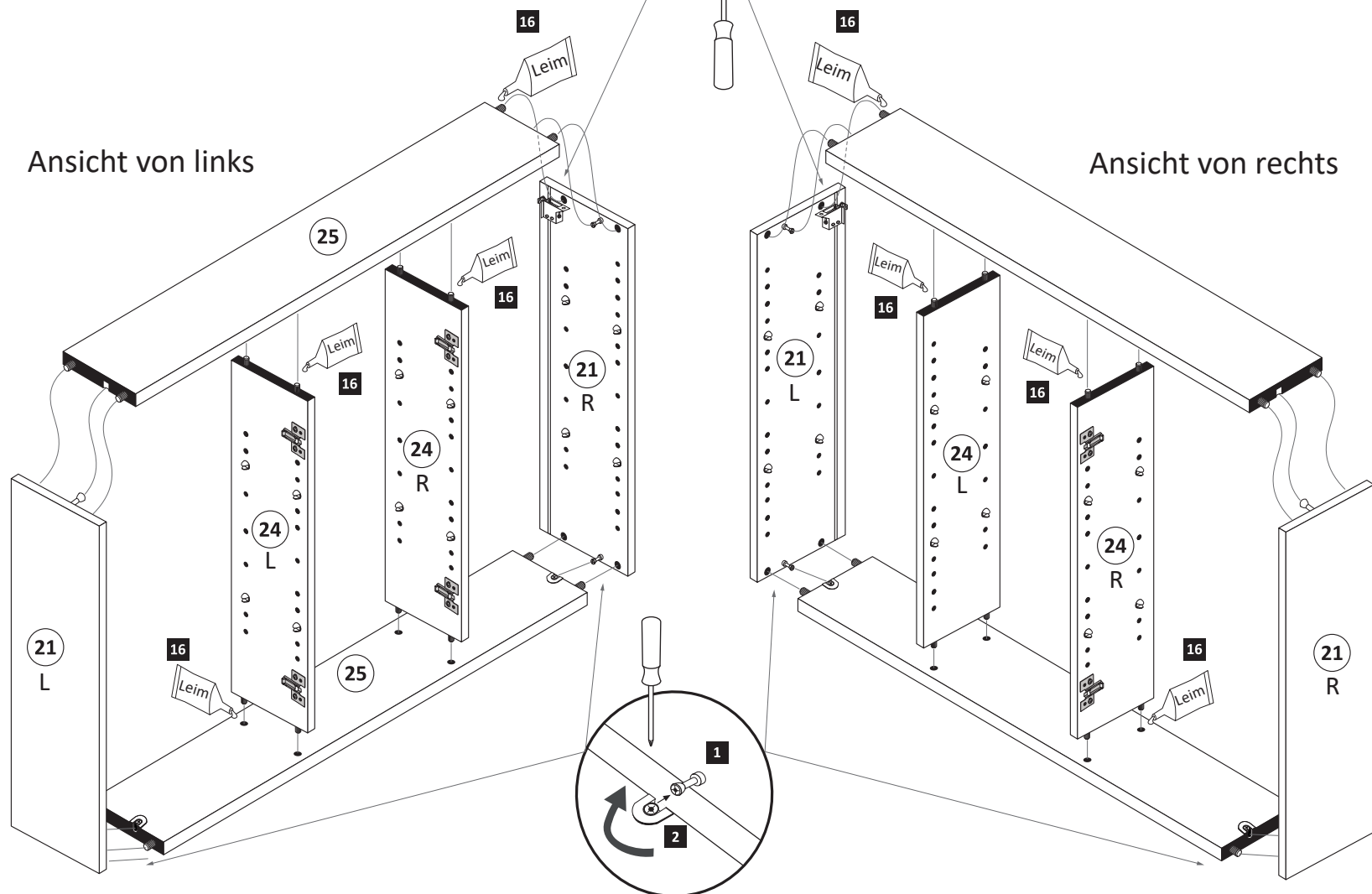

5

Bitte nur eine Variante auswählen und den entsprechenden Ausschnitt in einer Größe von maximal Trafobreite wie Trafohöhe - 10 mm aussägen. Trafomontage wird im Schritt 7 durchgeführt.

Variante 1: Trafomontage unten

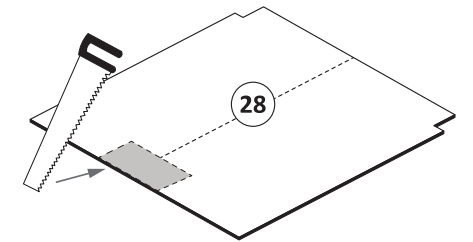
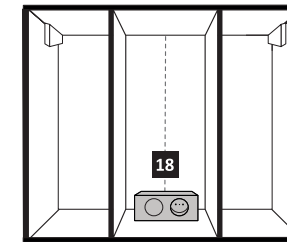

Variante 2: Trafomontage oben

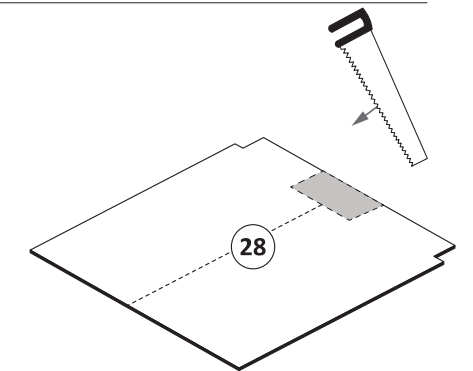
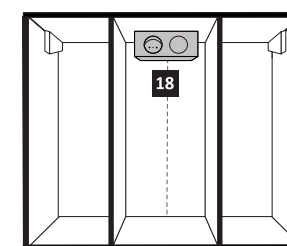

6

- 7 25 x 2862

ACHTUNG!
 Folgende Montageschritte mit dem Beispiel „Trafomontage Variante unten links“!

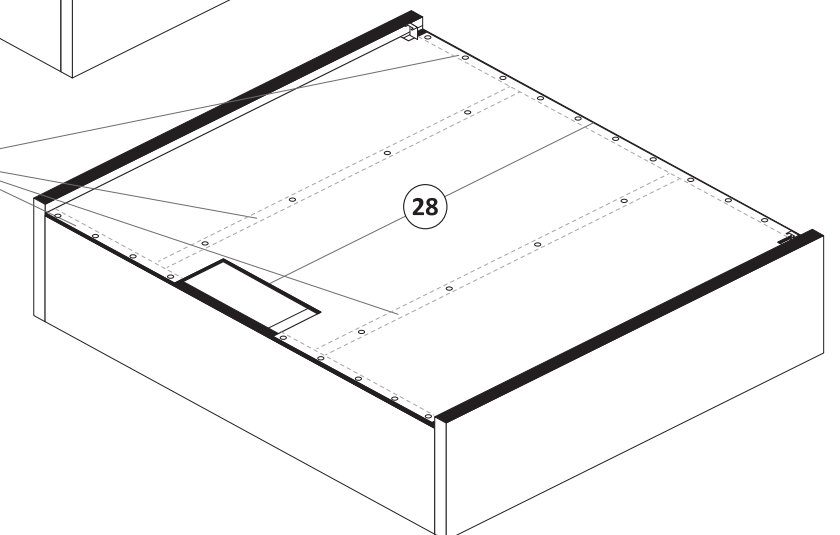
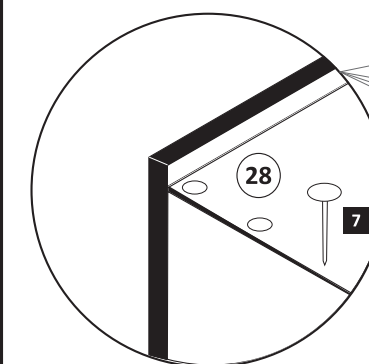
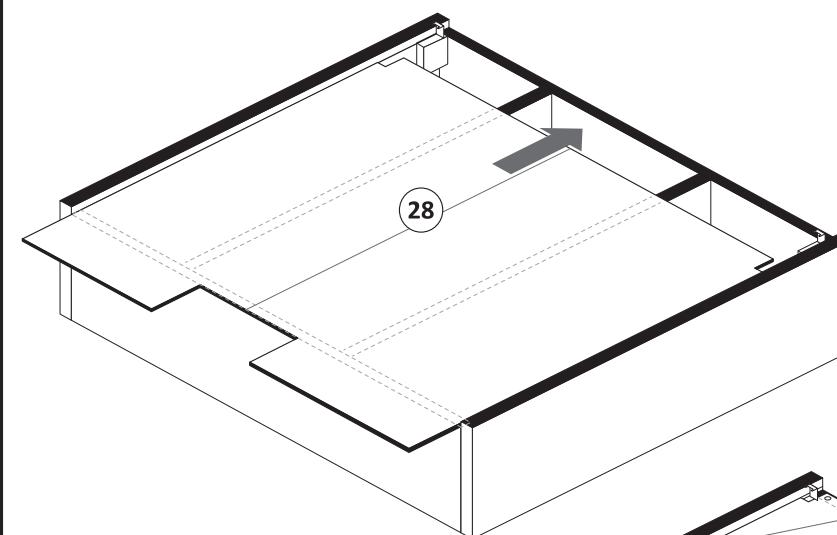

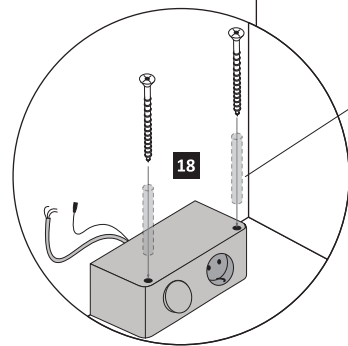
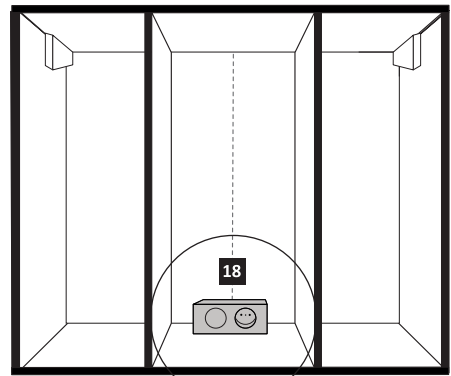
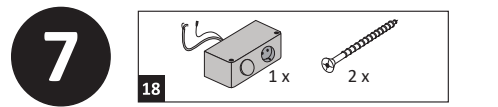

Achtung !!
Die Distanzhülsen sind optional im Lieferumfang.
Nur bei Bedarf nutzen.

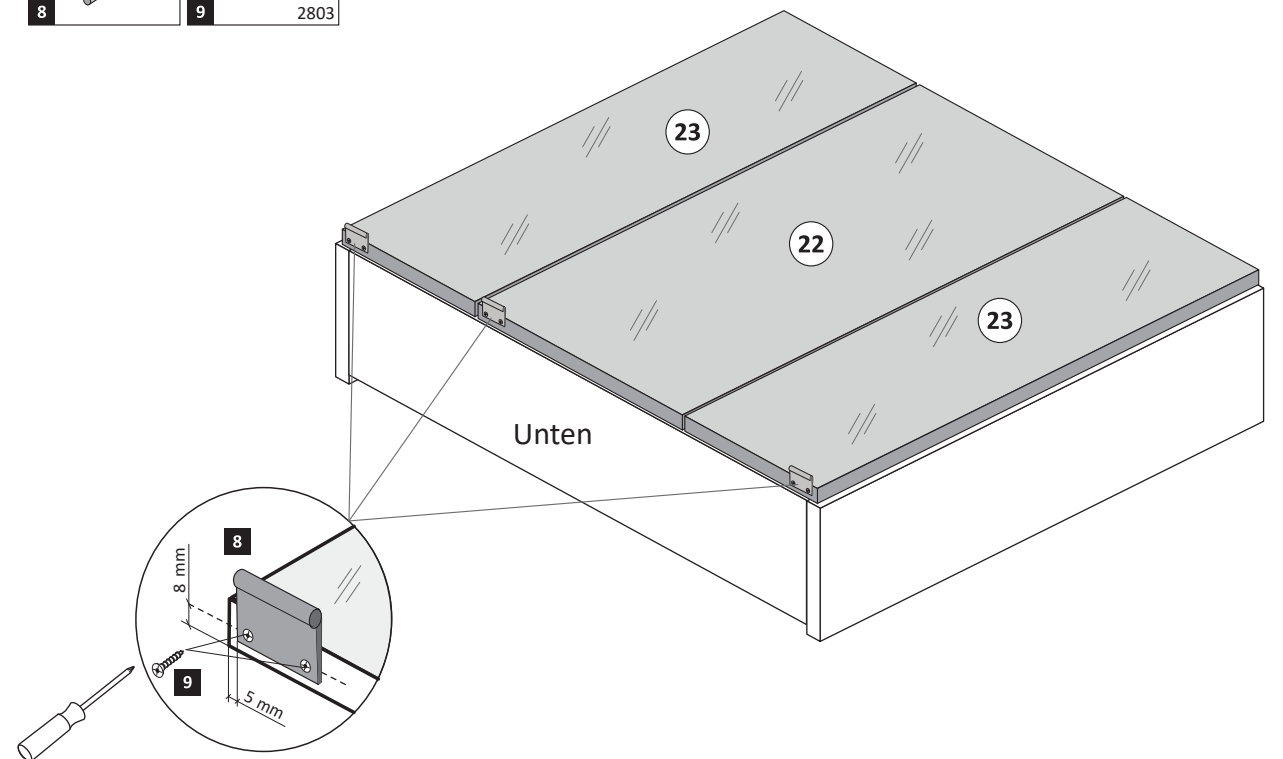
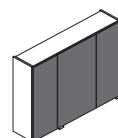
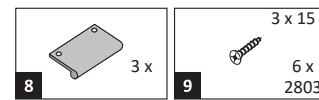
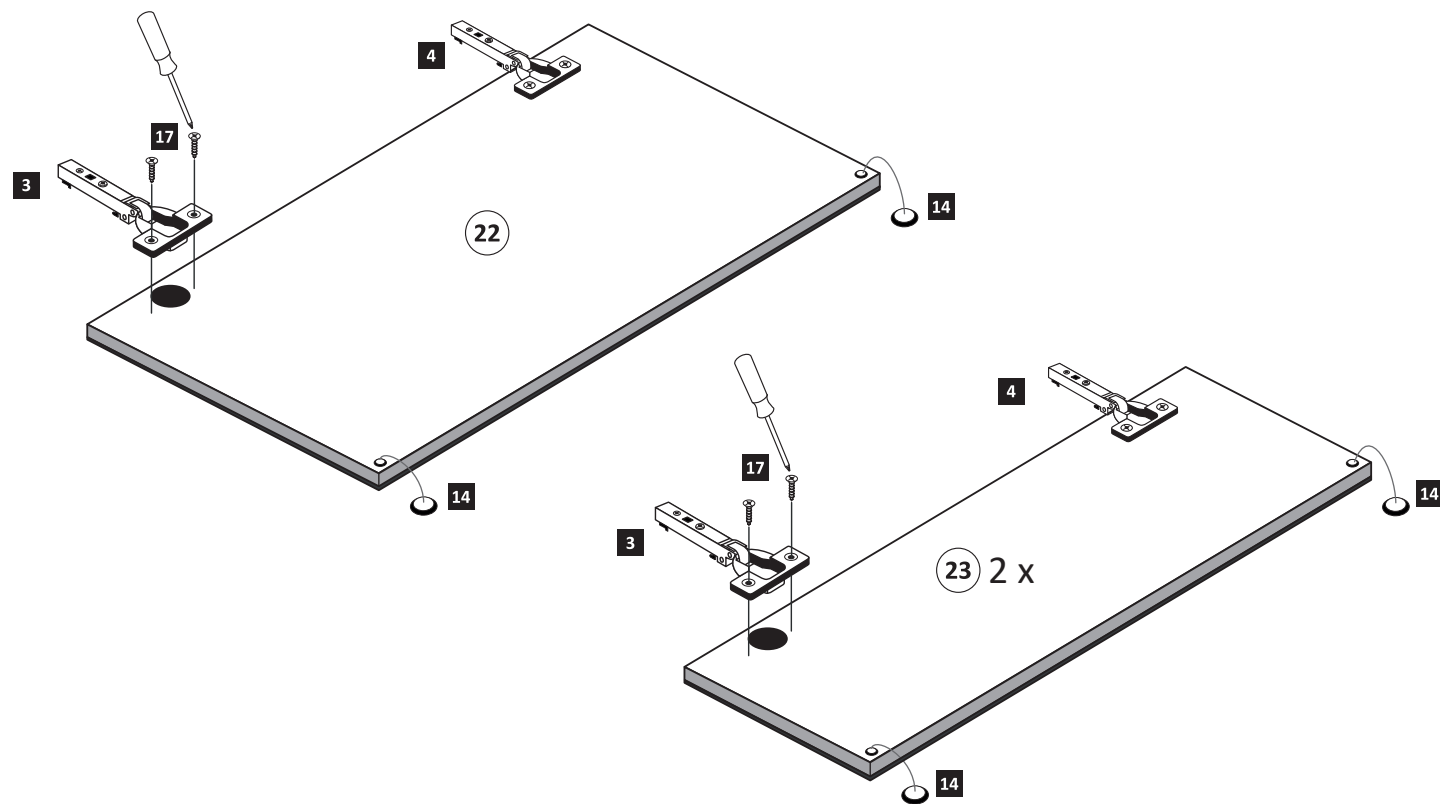
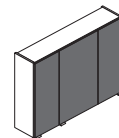
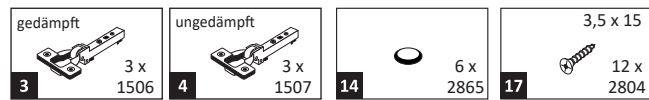
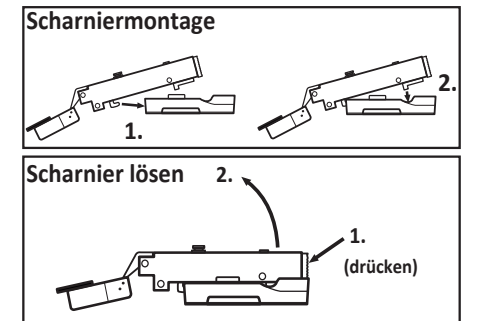
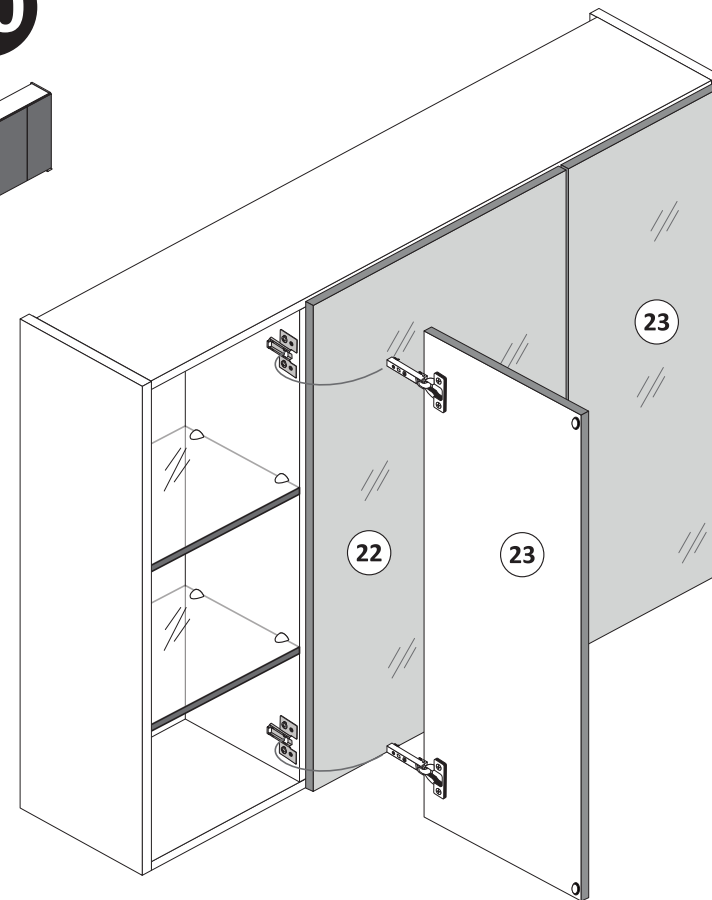
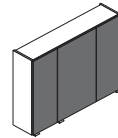
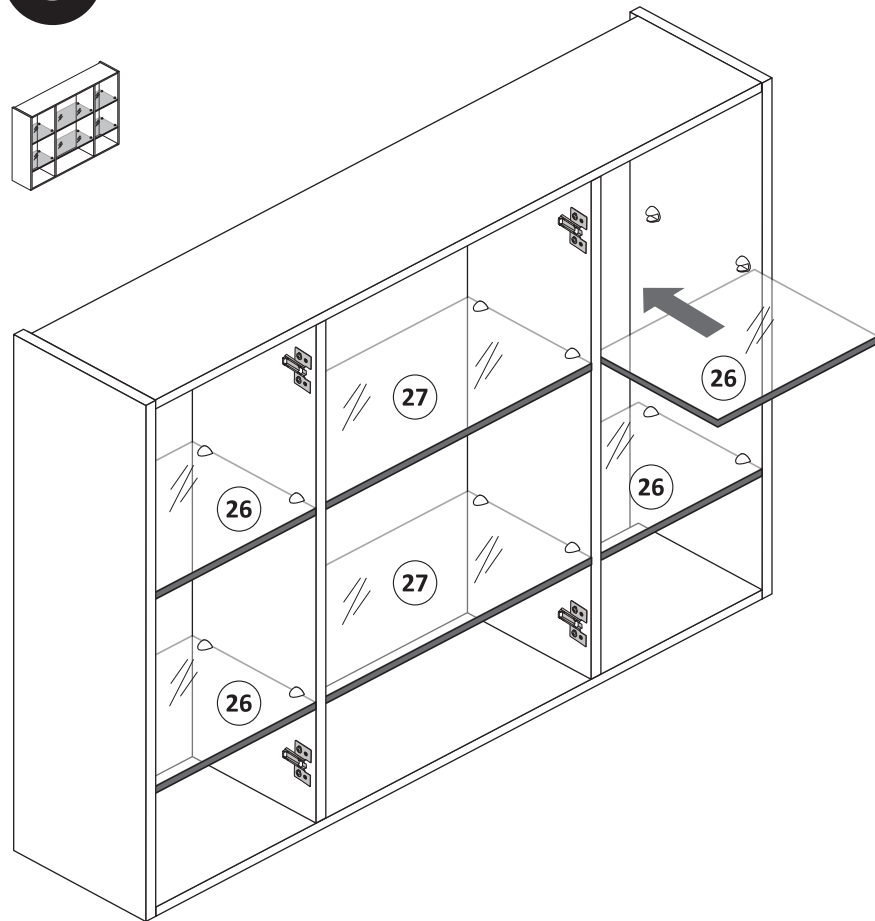
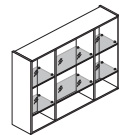

12

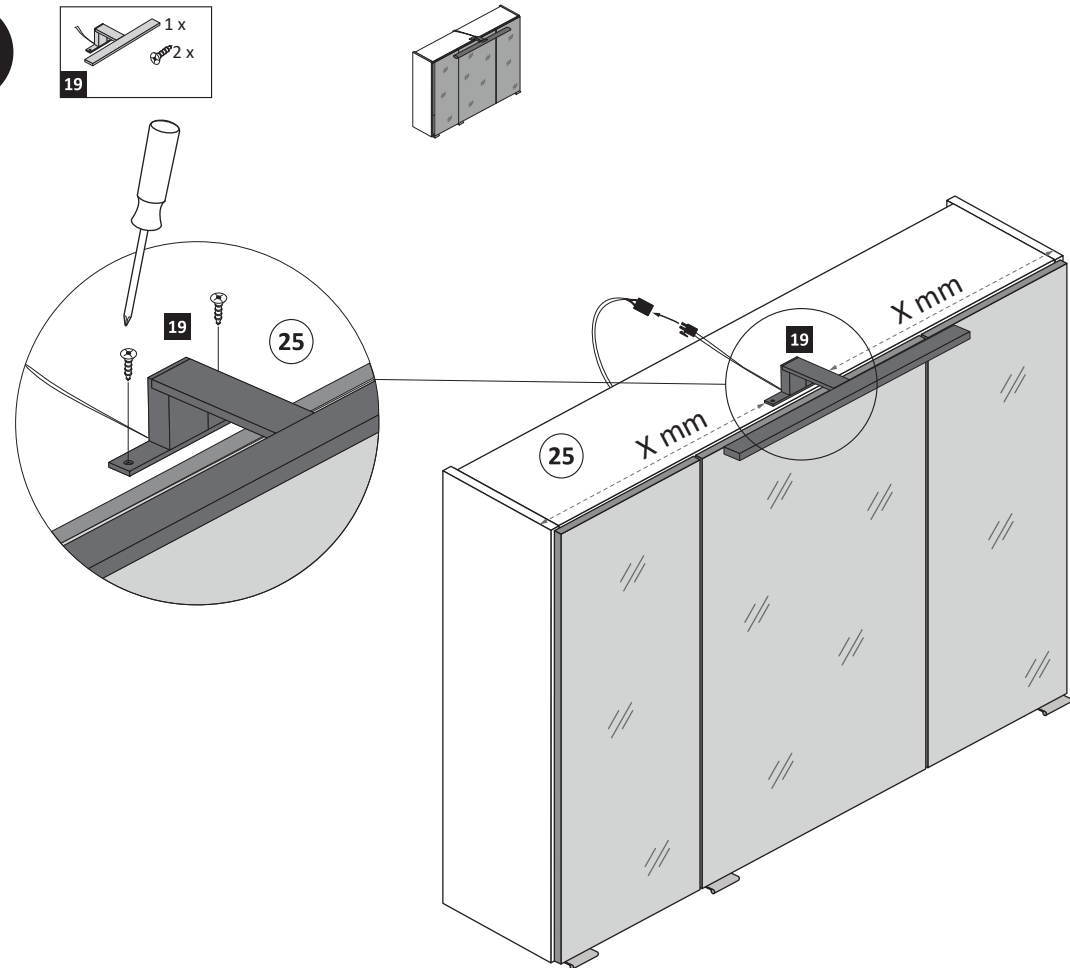

13

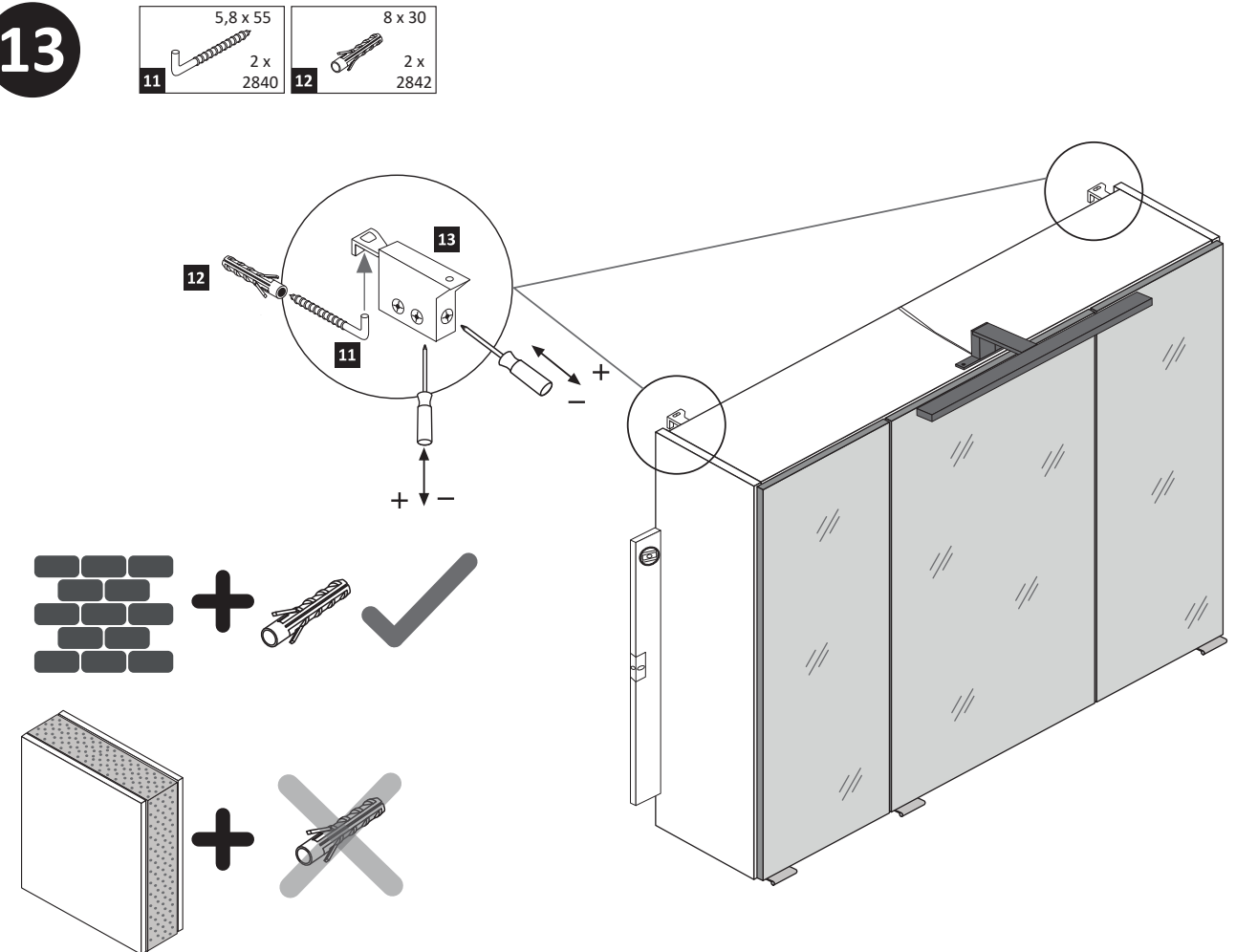

14

3,5 x 15
12 x 2804
17

1. Türen einstellen.

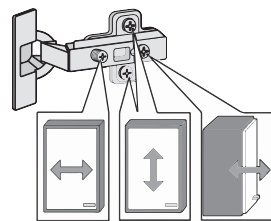

Achtung !!
Aus Sicherheitsgründen ist die Montage der Sicherungsschrauben zwingend notwendig. Nachdem montieren der Sicherungsschrauben ist die Höheneinstellung der Türen nicht mehr möglich!



2. Sicherungsschrauben montieren.

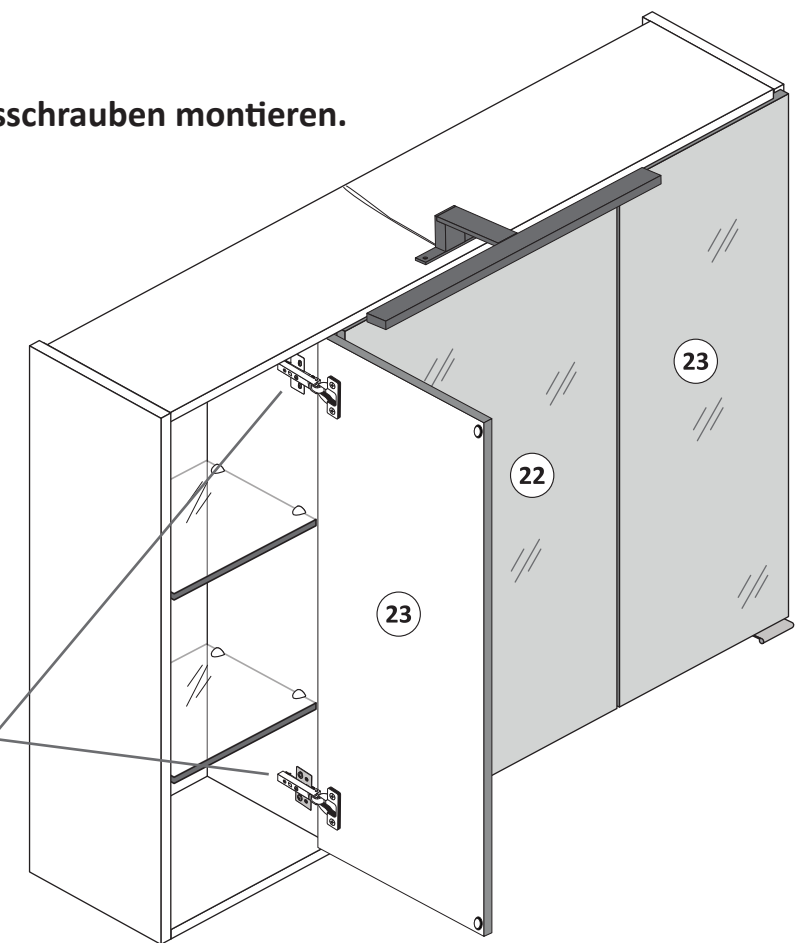
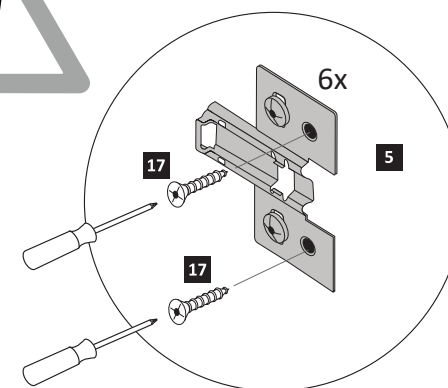
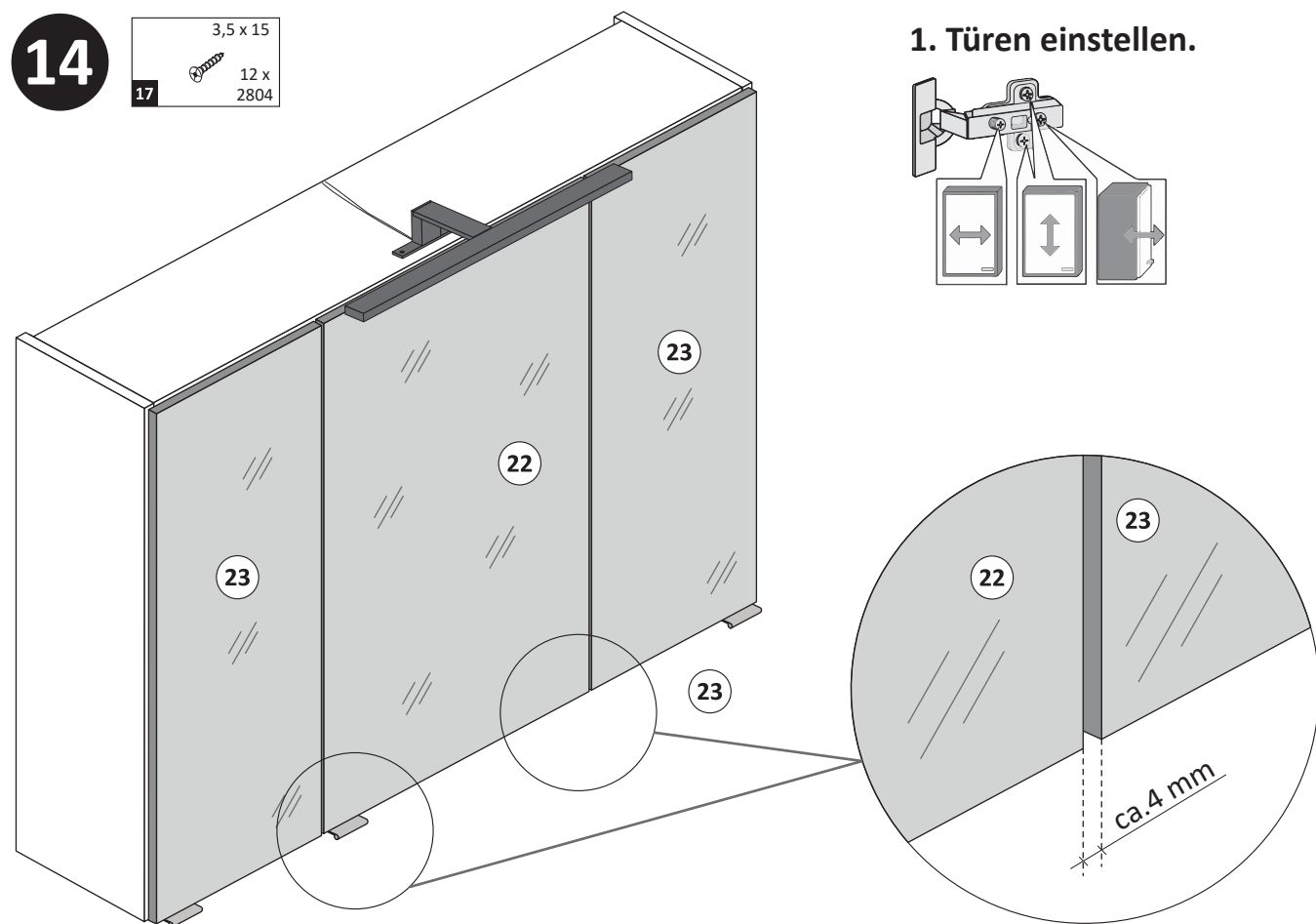



88085.532

1 4 x 2802	2 4 x 2801	gedämpft 3 x 1506	ungedämpft 3 x 1507	6 x 1614
6 24 x 2819	7 25 x 2862	8 3 x	3 x 15 6 x 2803	4 x 30 4 x 2812
5,8 x 55 2 x 2840	8 x 30 2 x 2842	13 2 x 2843	6 x 2865	8 x 30 16 x 2861
Leim 1 x 2863	3,5 x 15 26 x 2804	18 1 x 2 x	19 1 x 2 x	

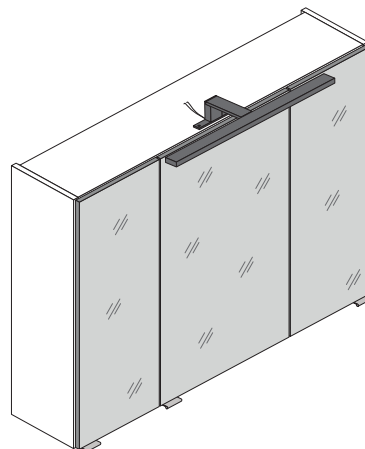
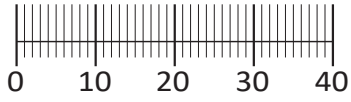
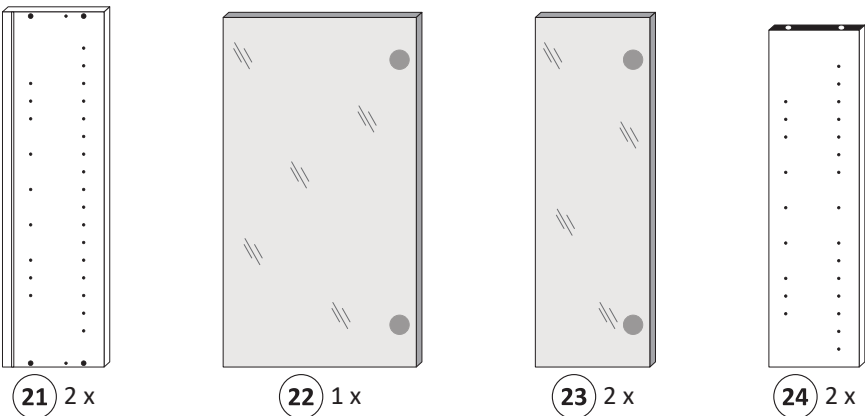

3D-Effekt

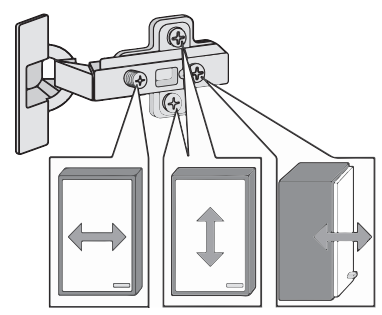
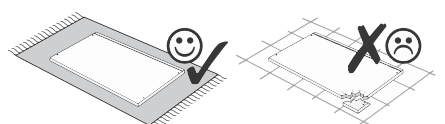
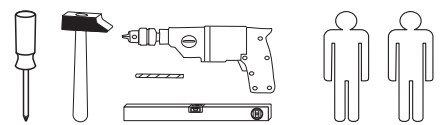
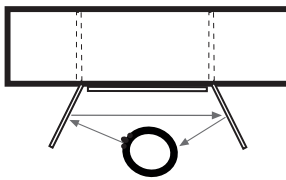

Held Möbel GmbH
Vogelparadies 9
32457 Porta Westfalica

Mail:
info@held-moebel.de



Diese Aufbauanleitung muss bis zum Ende der Nutzungszeit ihres Produktes sorgfältig aufbewahrt werden! Im Rahmen des Produkthaftungsgesetzes müssen Sie die Herstellerkennzeichnung aufbewahren. Zusätzlich kann Ihnen die Aufbauanleitung bei Ersatzteilbestellungen helfen, Bauteile und Beschläge eindeutig zu identifizieren.

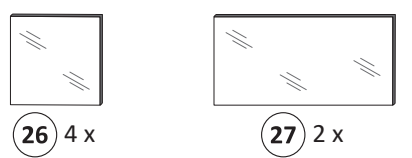
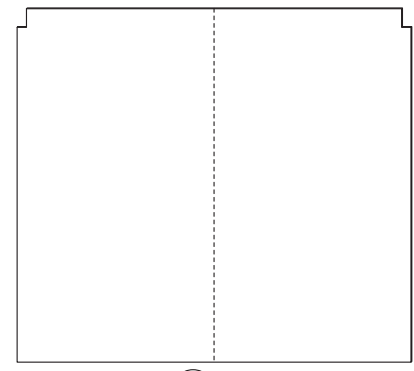
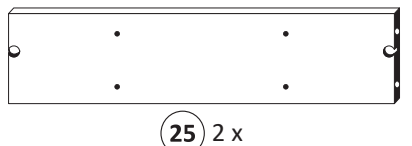

1

1 4 x 2802	6 8 x 2819	10 4 x 30 4 x 2812	13 2 x 2843
------------------	------------------	-----------------------------	-------------------

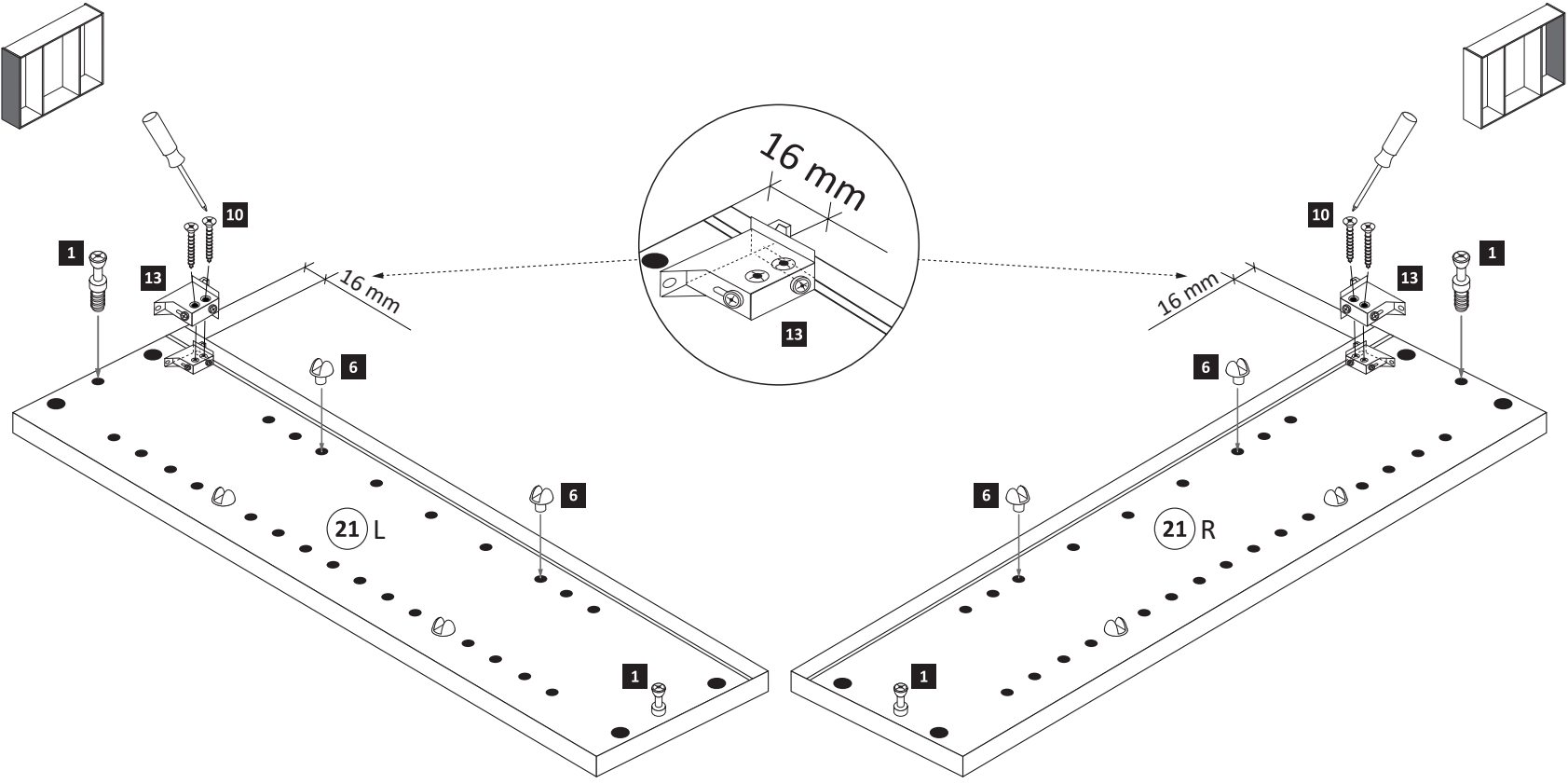

2

5 6 x 1614	6 16 x 2819	15 8 x 30 8 x 2861	16 Leim 1 x 2863
------------------	-------------------	-----------------------------	---------------------------

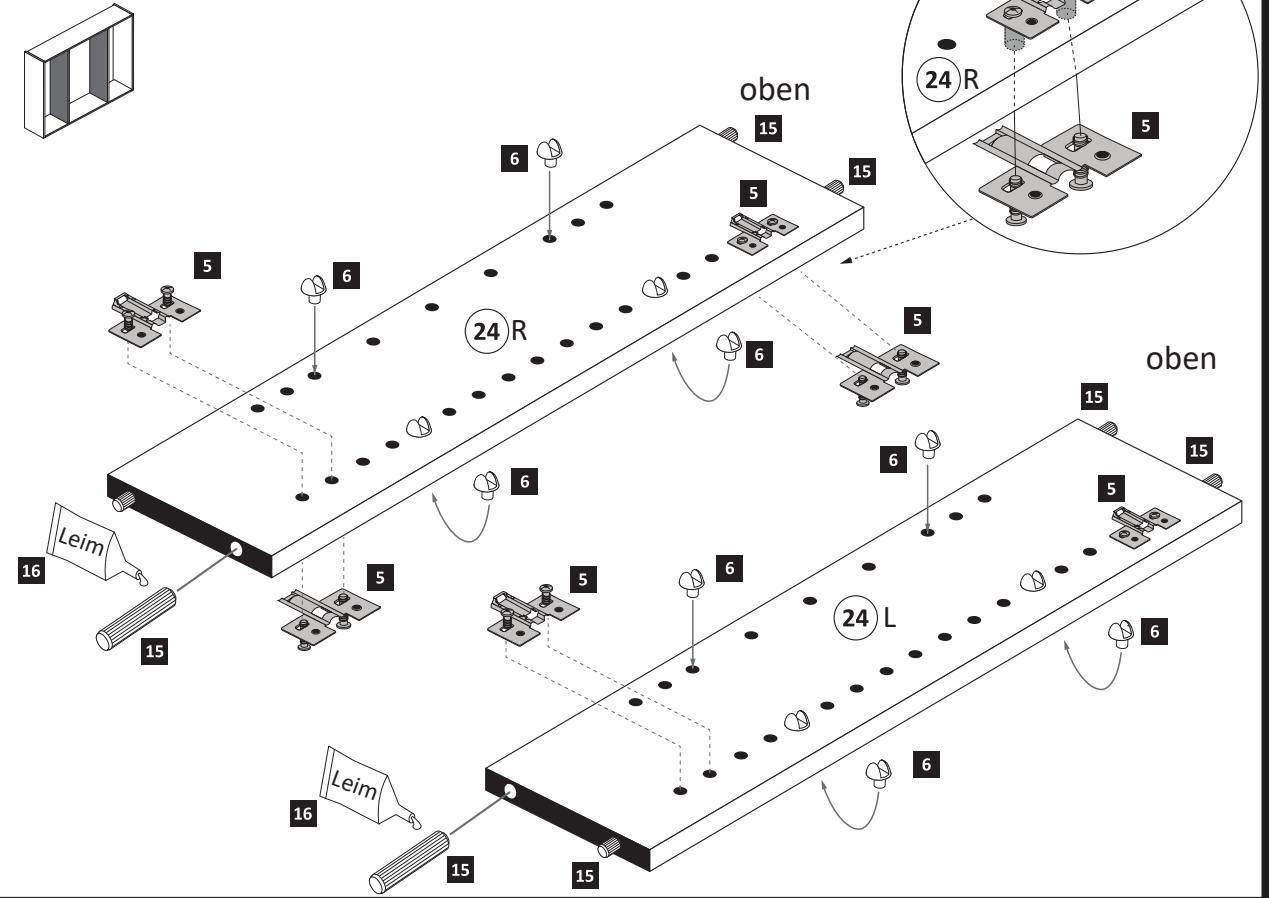

3

- 2 4 x 2801
- 15 8 x 30 8 x 2861
- 16 1 x 2863

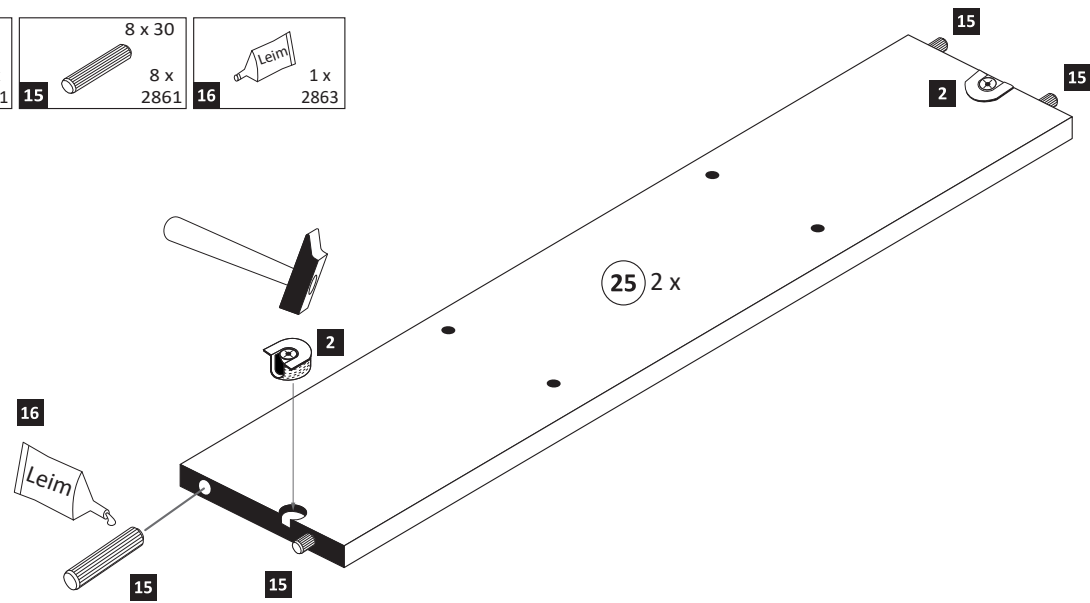

4

- 17 3,5 x 15 2 x 2804

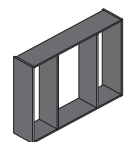

- 16 1 x 2863
 - D Leim
 - GB Glue
 - NL Lijm
 - PL Klej
 - TR Tutkal
 - F Colle
 - I Colla
- 20 min.

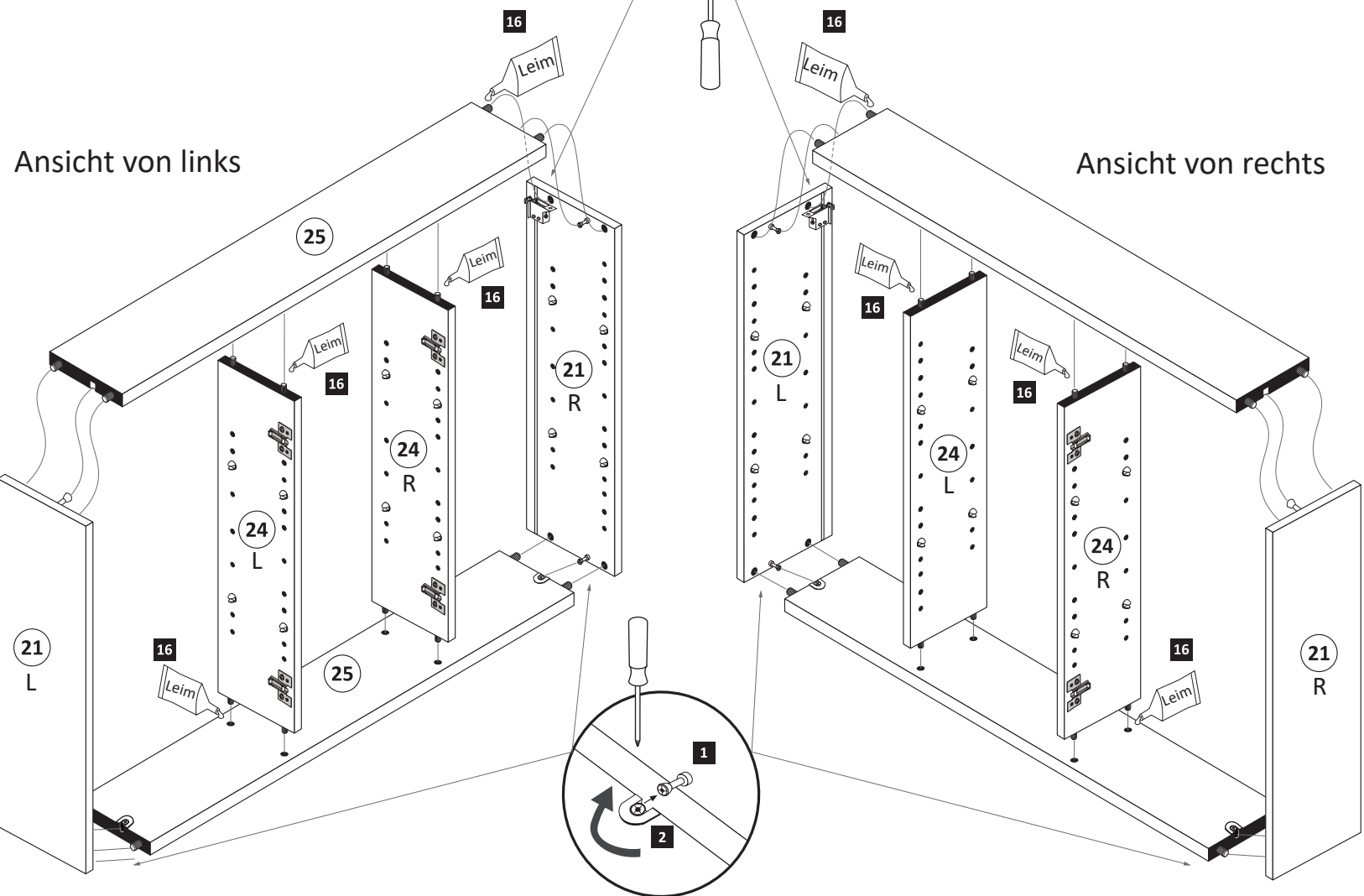

5

Bitte nur eine Variante auswählen und den entsprechenden Ausschnitt in einer Größe von maximal Trafobreite wie Trafohöhe - 10 mm aussägen. Trafomontage wird im Schritt 7 durchgeführt.

Variante 1: Trafomontage unten

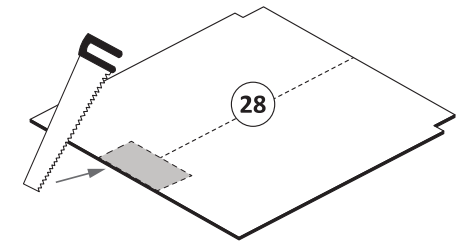
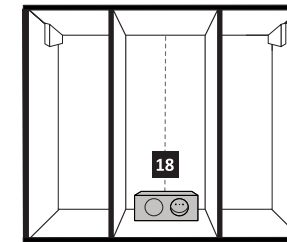

Variante 2: Trafomontage oben

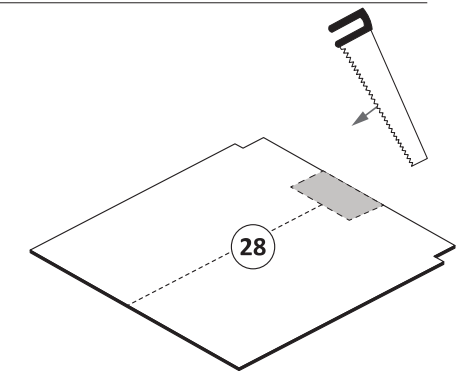
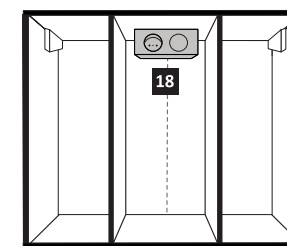

6

- 7 25 x 2862

ACHTUNG!
Folgende Montageschritte mit dem Beispiel „Trafomontage Variante unten links“!

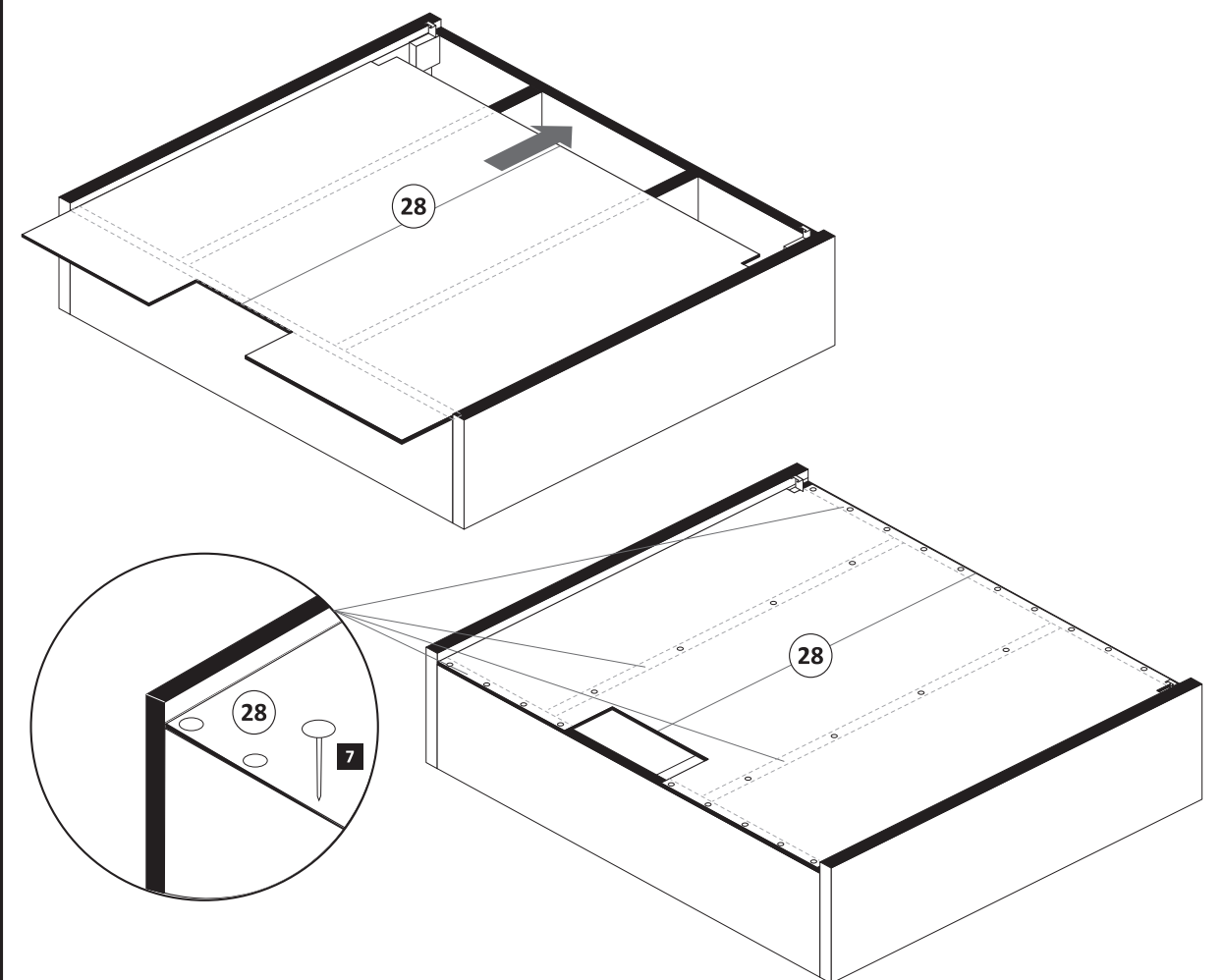

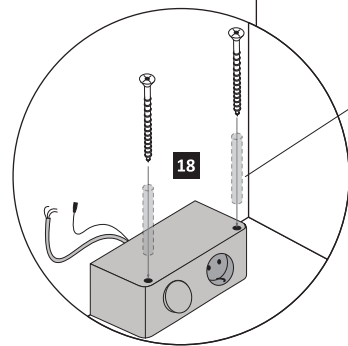
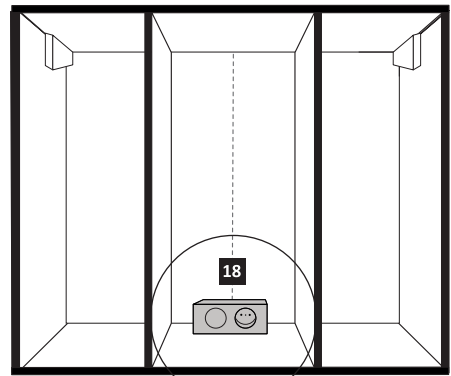
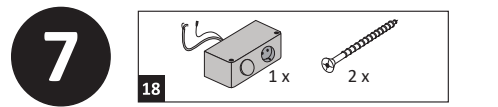

Achtung !!
Die Distanzhülsen sind optional im Lieferumfang.
Nur bei Bedarf nutzen.

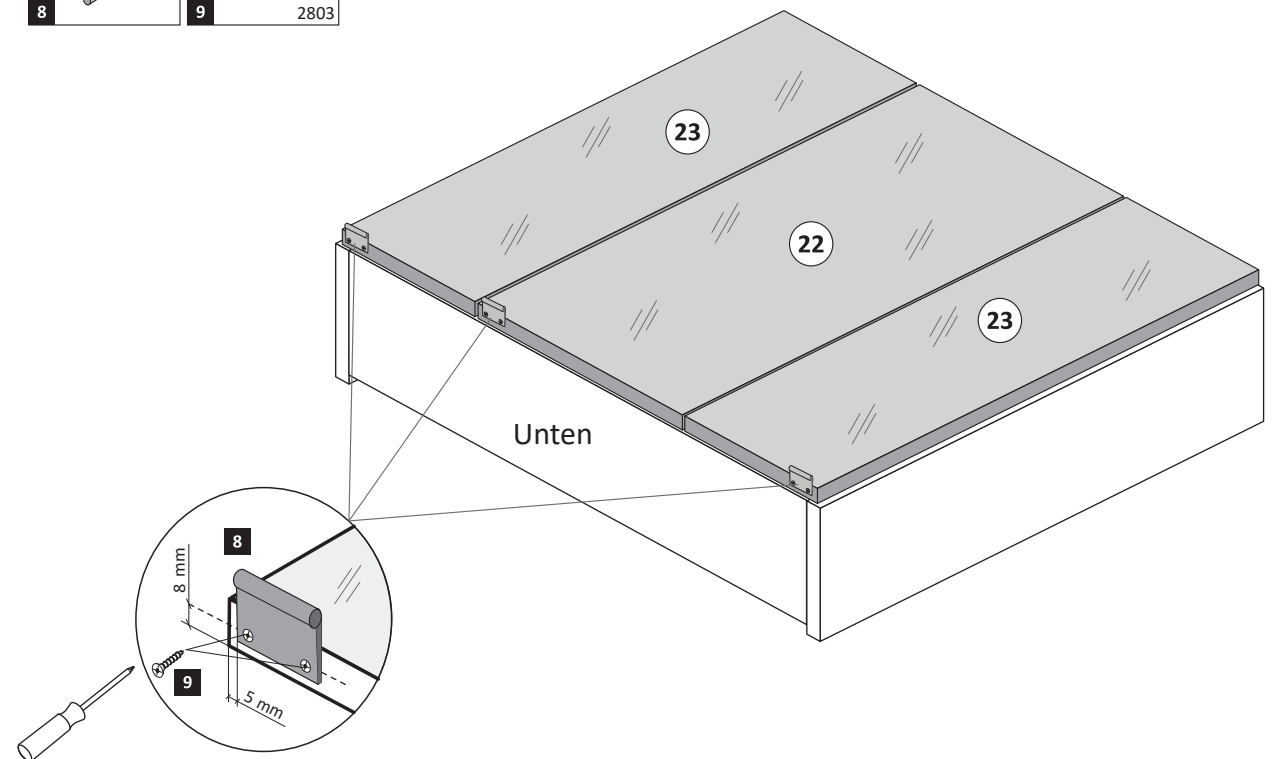
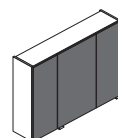
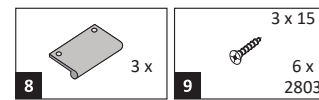
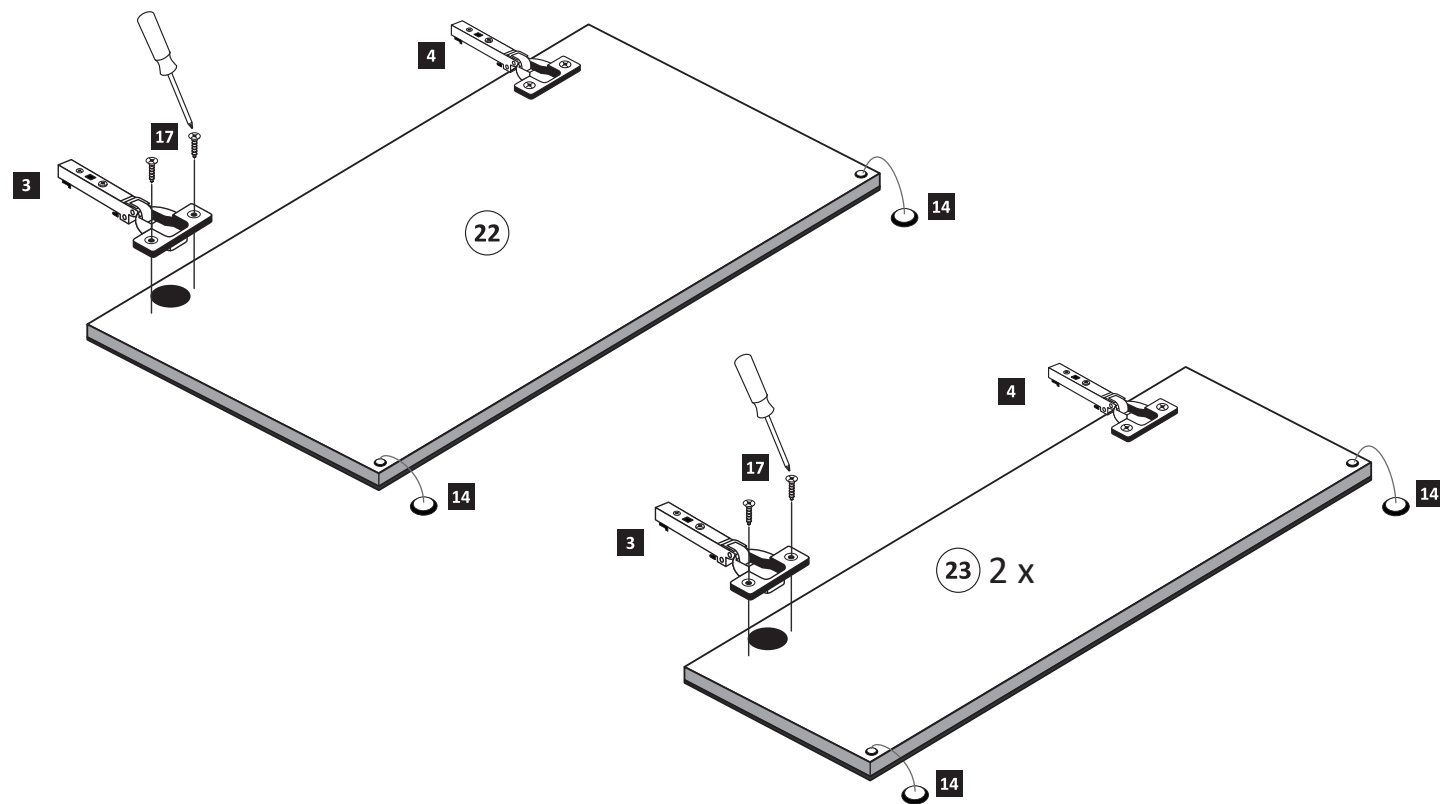
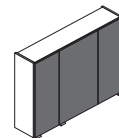
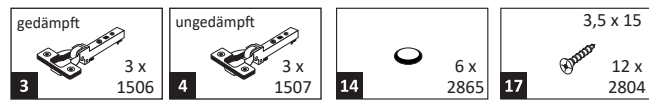
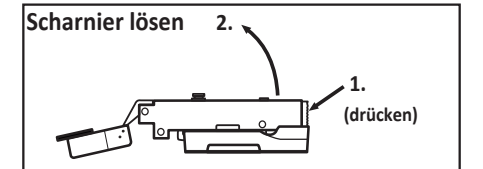
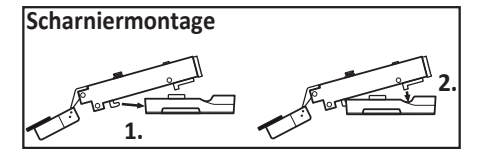
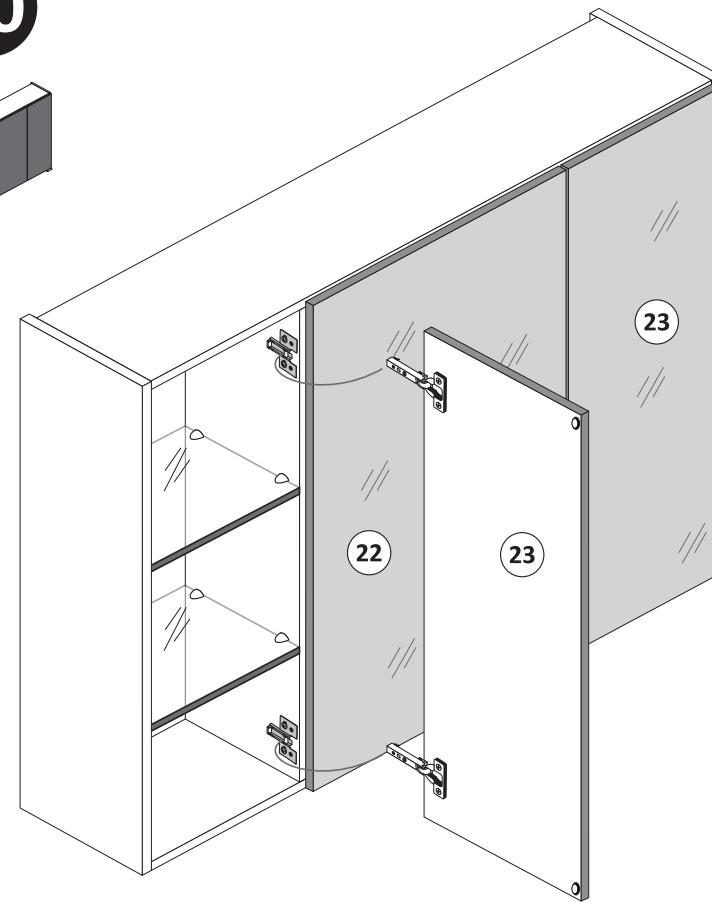
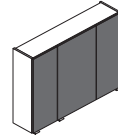
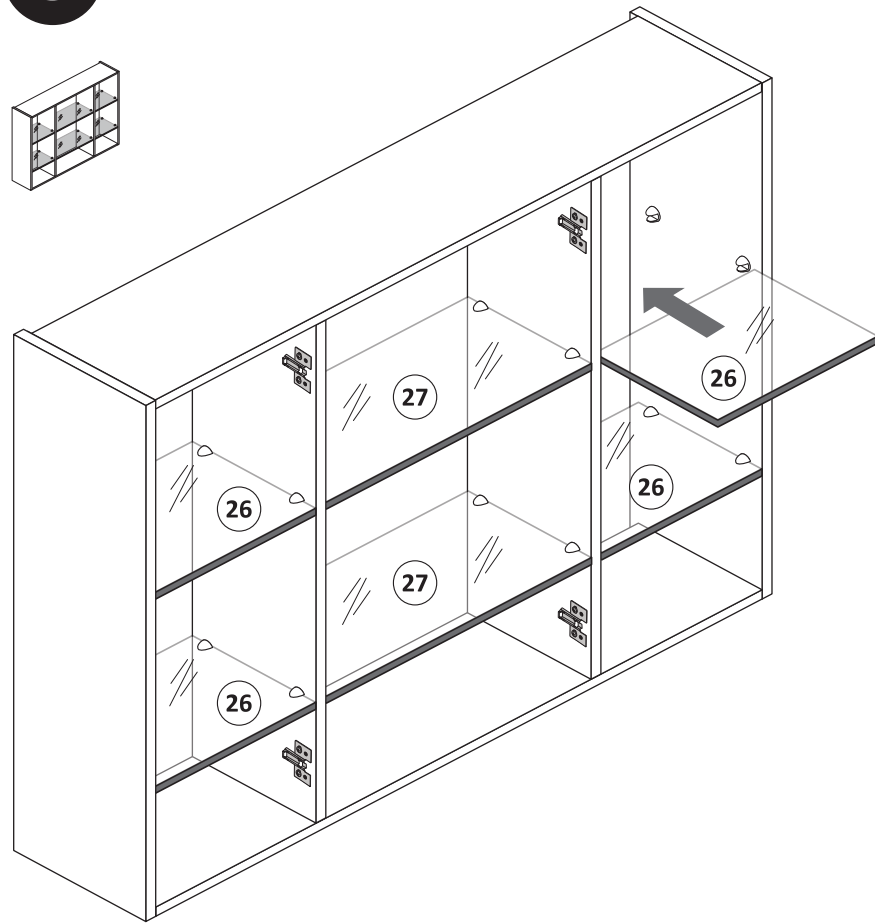
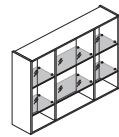

12

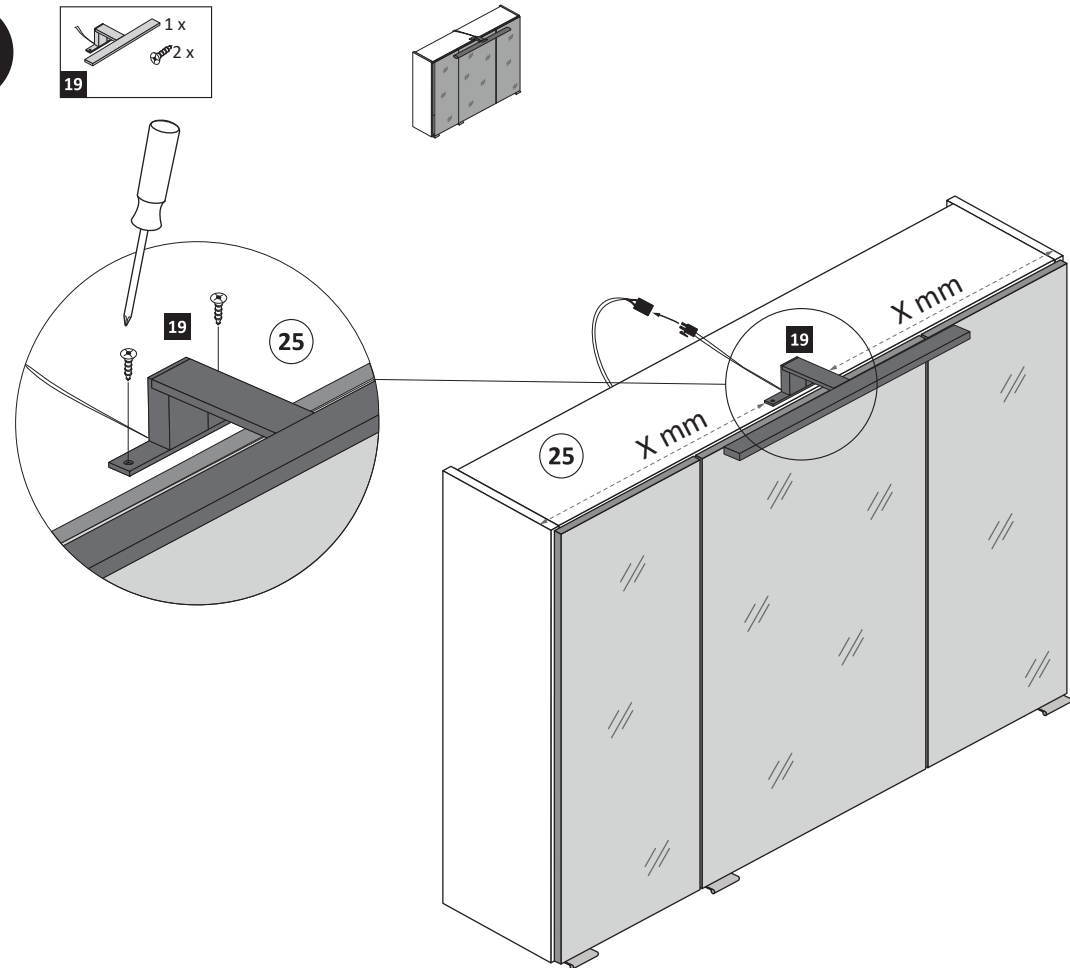

13

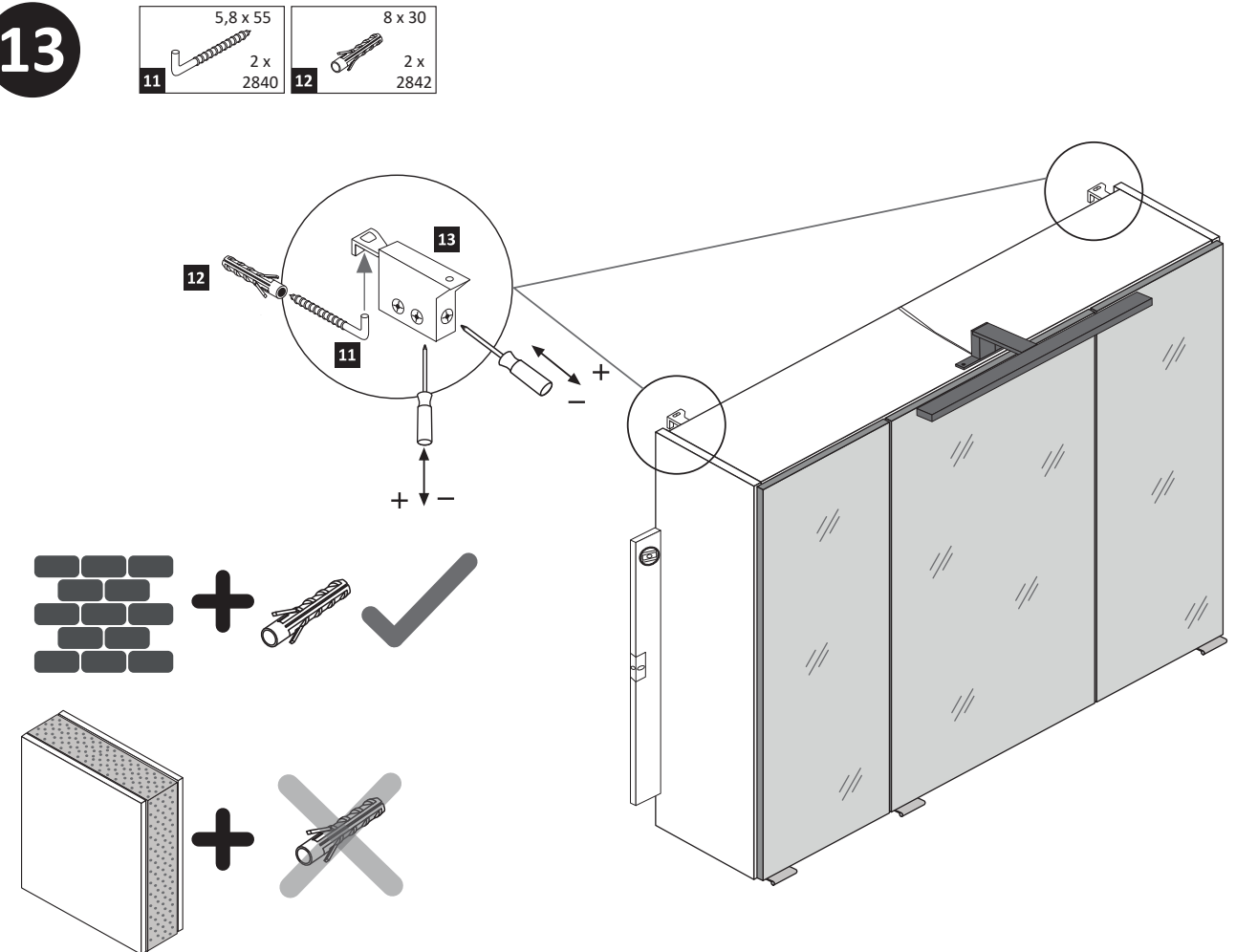

14

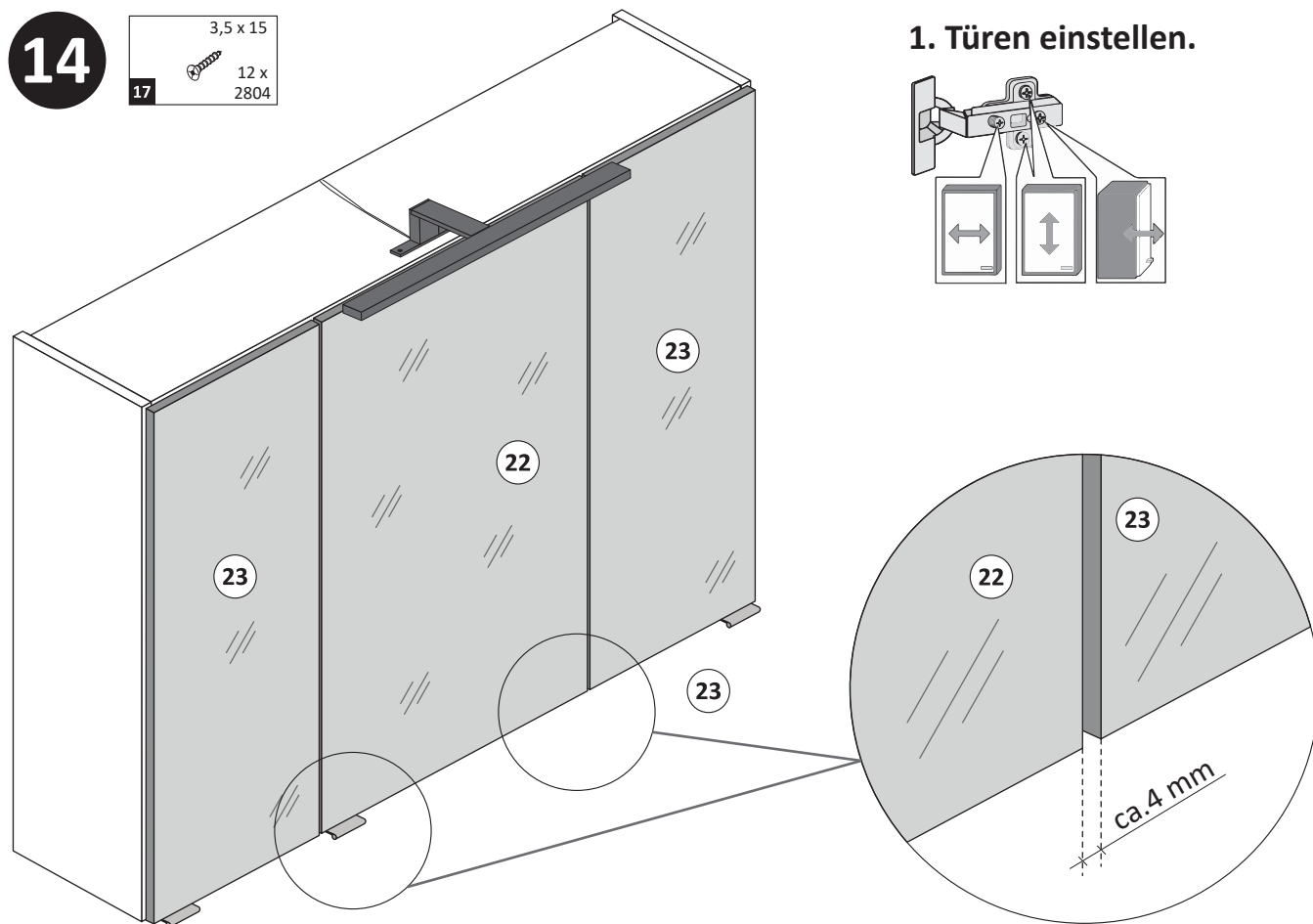

1. Türen einstellen.

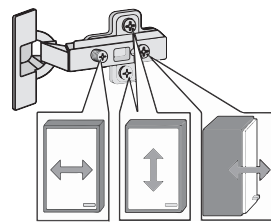

Achtung !!
Aus Sicherheitsgründen ist die Montage der Sicherungsschrauben zwingend notwendig. Nachdem montieren der Sicherungsschrauben ist die Höheneinstellung der Türen nicht mehr möglich!

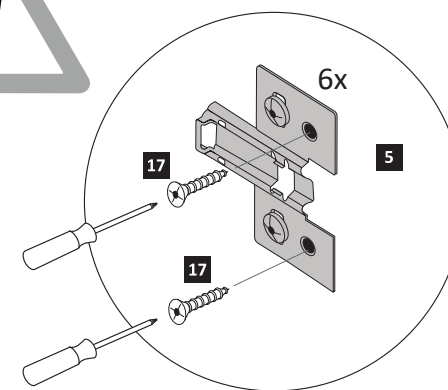

2. Sicherungsschrauben montieren.

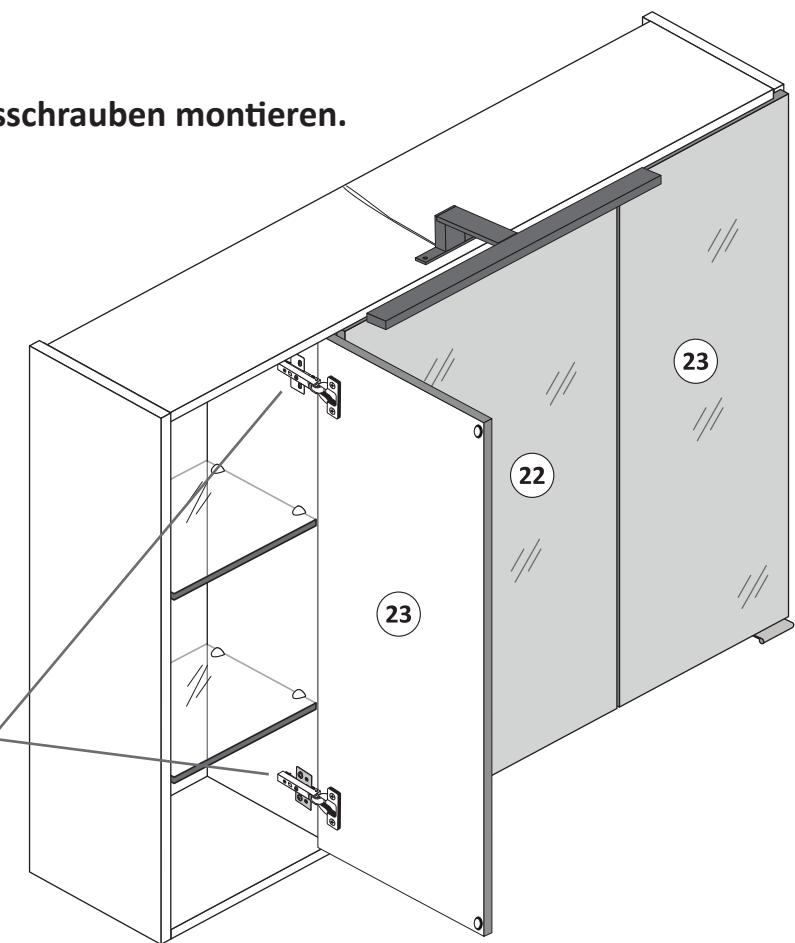



88085.532

1 4 x 2802	2 4 x 2801	gedämpft 3 x 1506	ungedämpft 3 x 1507	6 x 1614
6 24 x 2819	7 25 x 2862	8 3 x	3 x 15 6 x 2803	4 x 30 4 x 2812
5,8 x 55 2 x 2840	8 x 30 2 x 2842	13 2 x 2843	6 x 2865	8 x 30 16 x 2861
Leim 1 x 2863	3,5 x 15 26 x 2804	18 1 x 2 x	19 1 x 2 x	

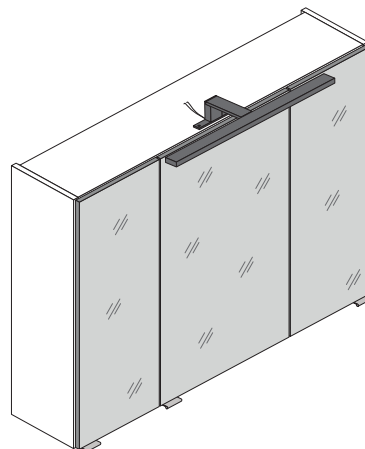
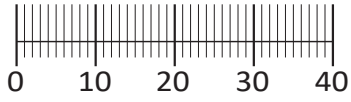
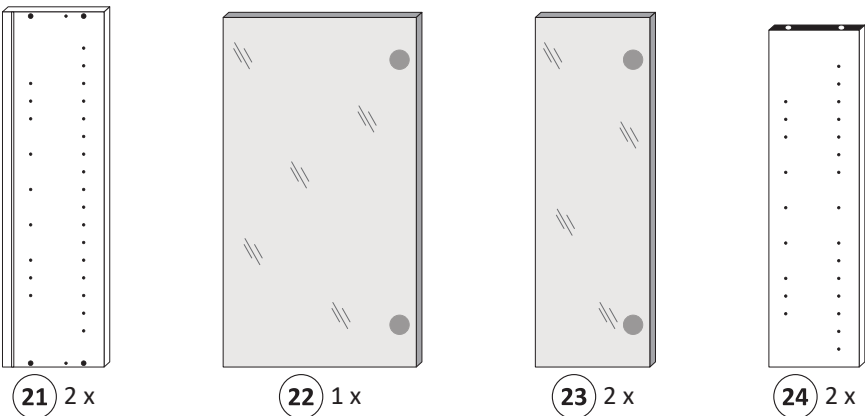

3D-Effekt

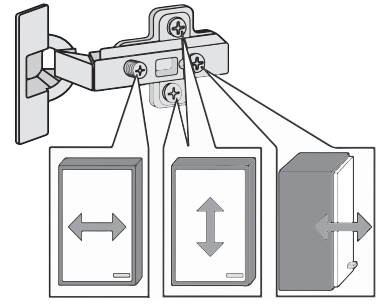
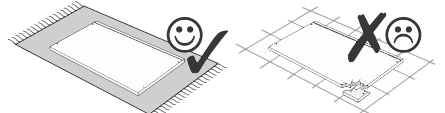
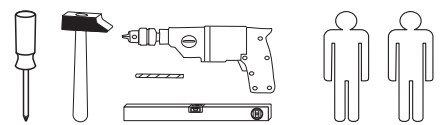
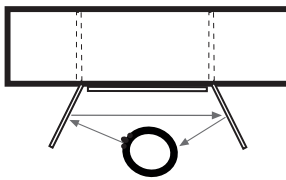

Held Möbel GmbH
Vogelparadies 9
32457 Porta Westfalica

Mail:
info@held-moebel.de



Diese Aufbauanleitung muss bis zum Ende der Nutzungszeit ihres Produktes sorgfältig aufbewahrt werden! Im Rahmen des Produkthaftungsgesetzes müssen Sie die Herstellerkennzeichnung aufbewahren. Zusätzlich kann Ihnen die Aufbauanleitung bei Ersatzteilbestellungen helfen, Bauteile und Beschläge eindeutig zu identifizieren.

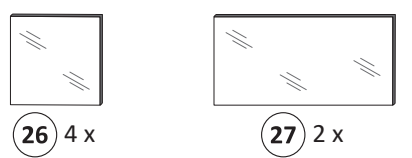
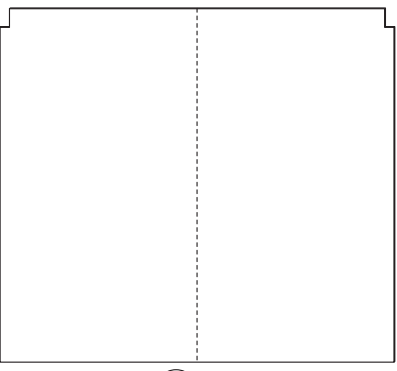
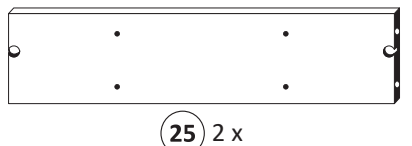

1

1 4 x 2802	6 8 x 2819	10 4 x 30 4 x 2812	13 2 x 2843
------------------	------------------	-----------------------------	-------------------

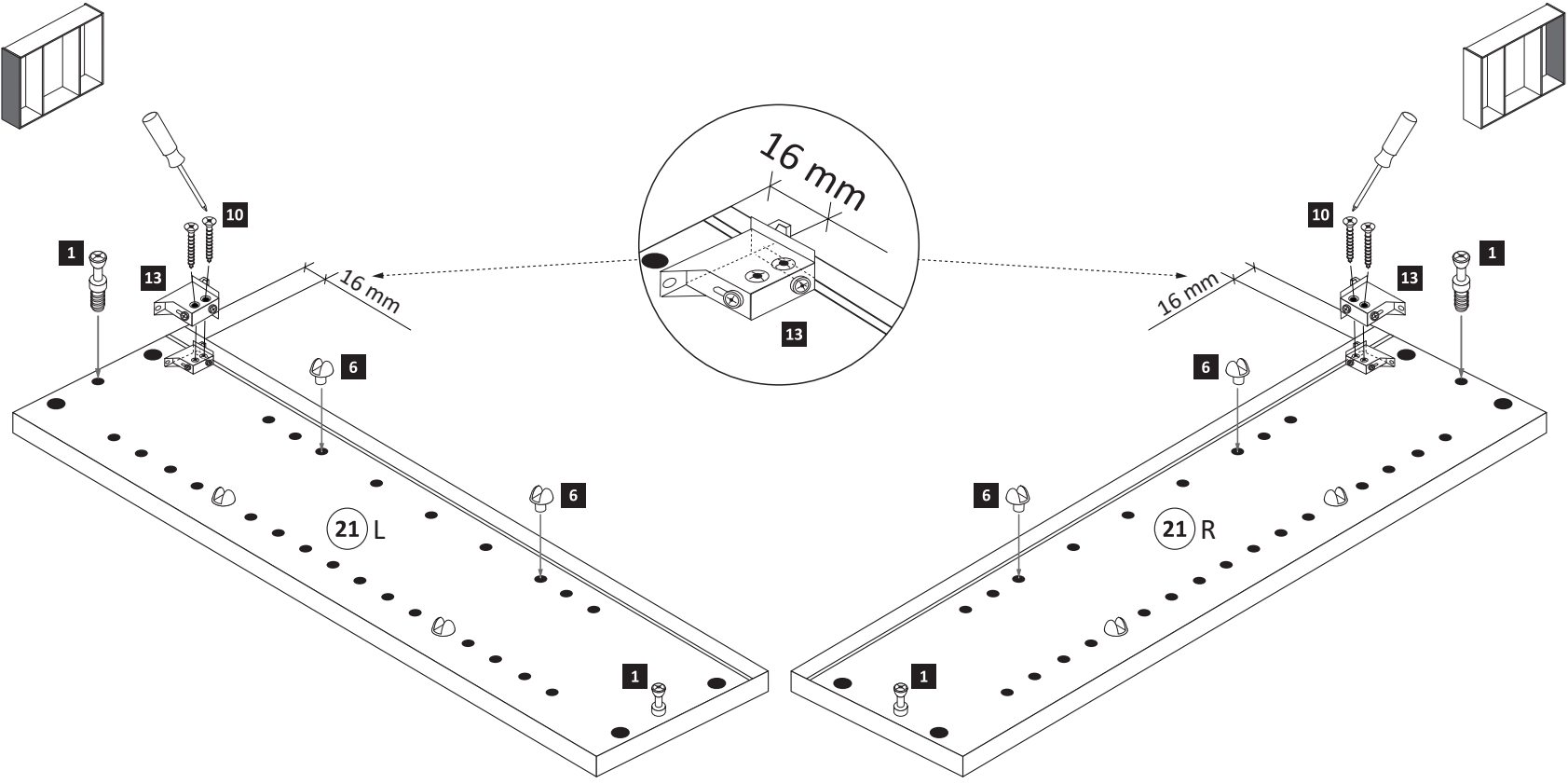

2

5 6 x 1614	6 16 x 2819	15 8 x 30 8 x 2861	16 Leim 1 x 2863
------------------	-------------------	-----------------------------	---------------------------

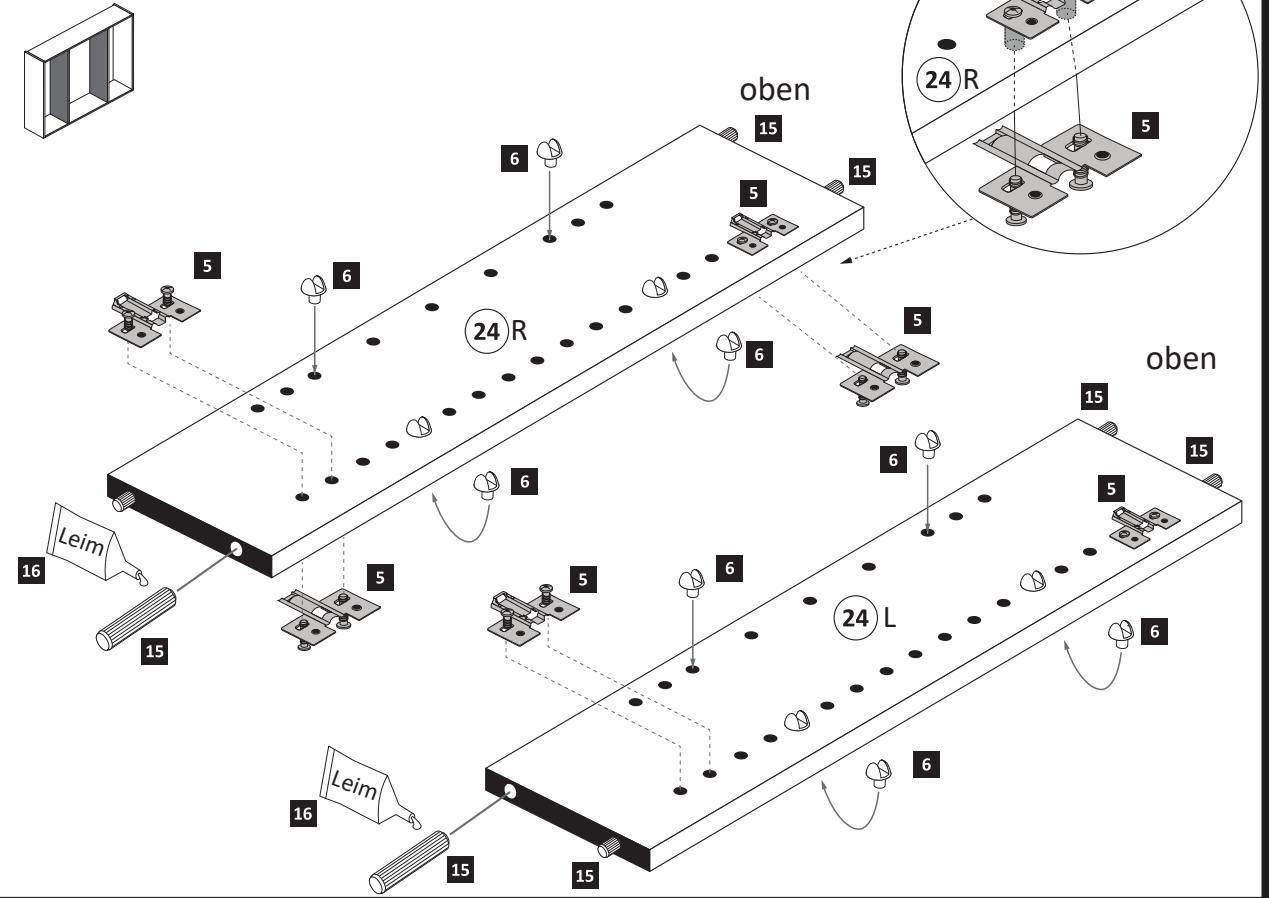

3

- 2 4 x 2801
- 15 8 x 30 8 x 2861
- 16 Leim 1 x 2863

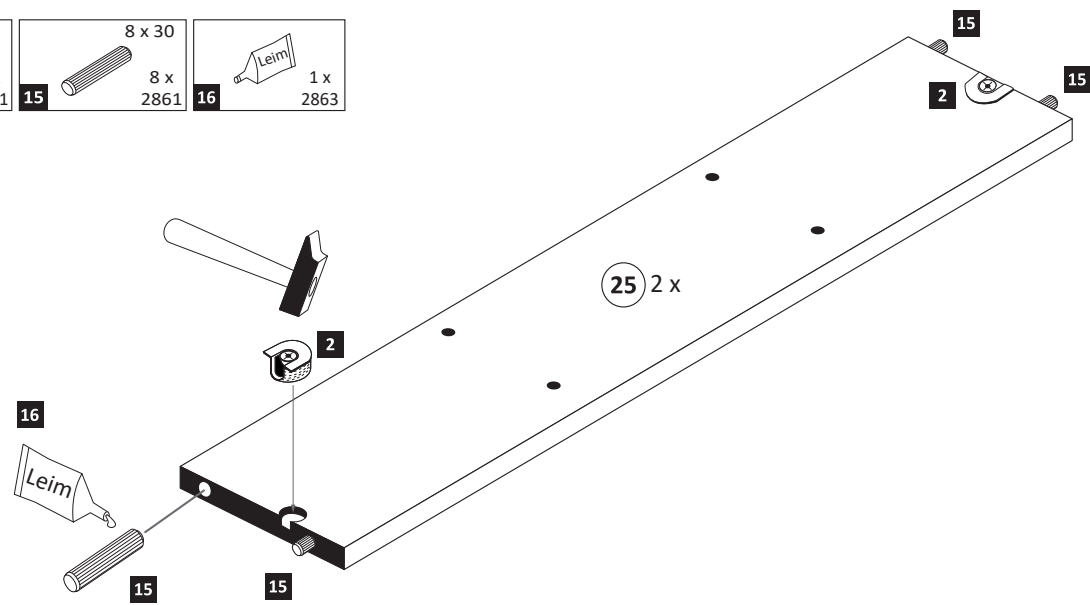

4

- 17 3,5 x 15 2 x 2804

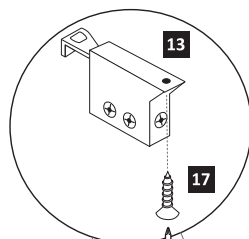
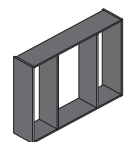

- 16 20 min.
- 16 Leim 1 x 2863
- D Leim
- GB Glue
- NL Lijm
- PL Klej
- TR Tutkal
- F Colle
- I Colla

Ansicht von links

Ansicht von rechts

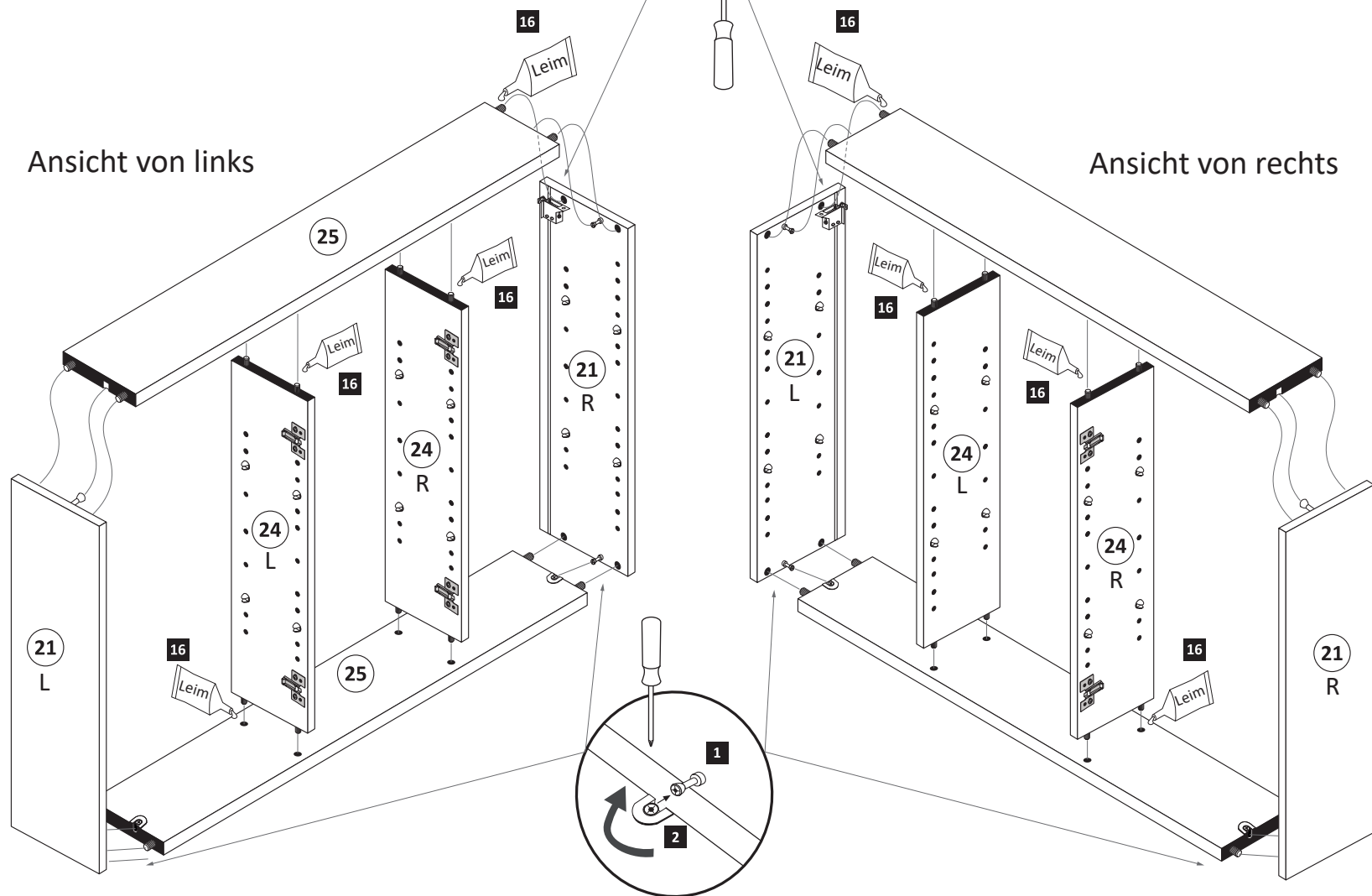

5

Bitte nur eine Variante auswählen und den entsprechenden Ausschnitt in einer Größe von maximal Trafobreite wie Trafohöhe - 10 mm aussägen. Trafomontage wird im Schritt 7 durchgeführt.

Variante 1: Trafomontage unten

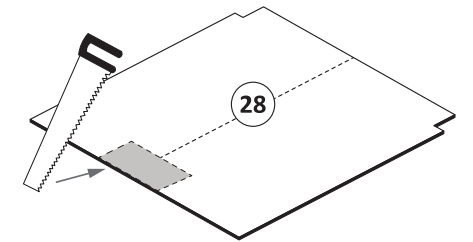
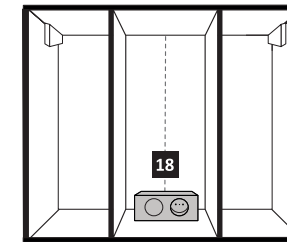

Variante 2: Trafomontage oben

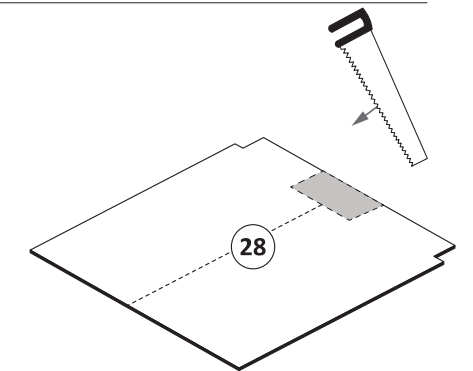
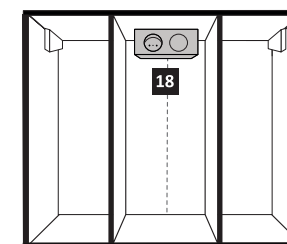

6

- 7 25 x 2862

ACHTUNG!
Folgende Montageschritte mit dem Beispiel „Trafomontage Variante unten links“!

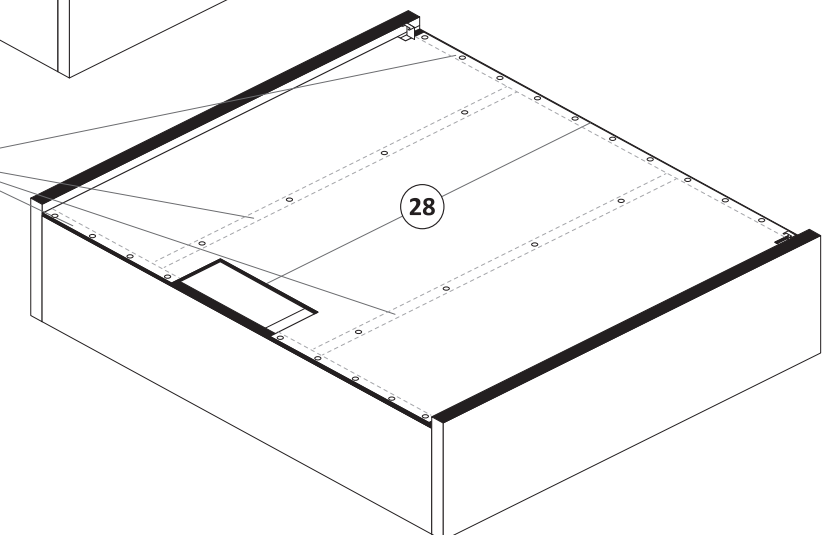
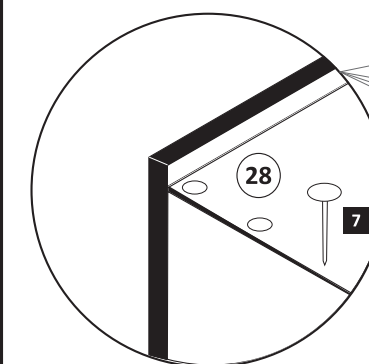
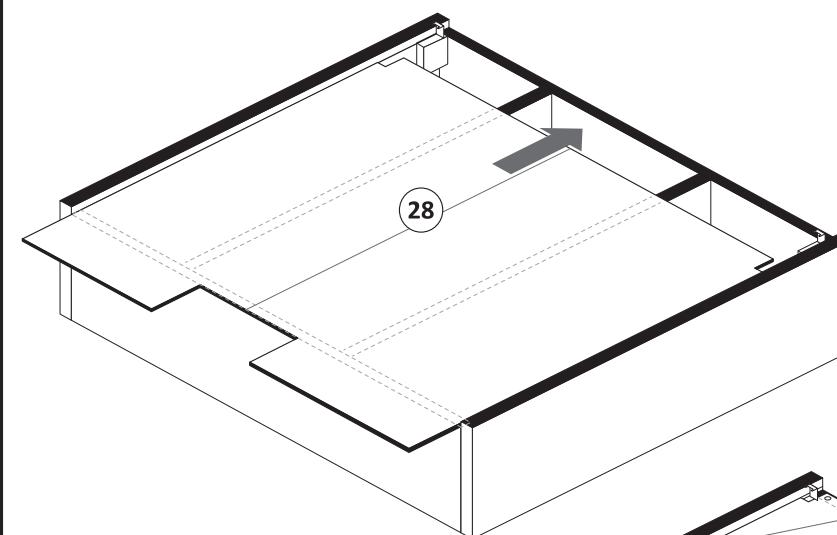

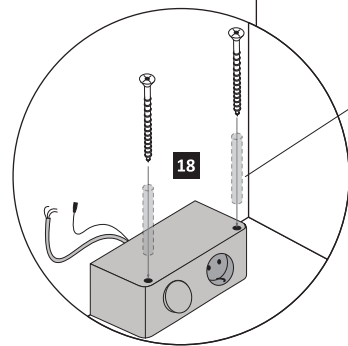
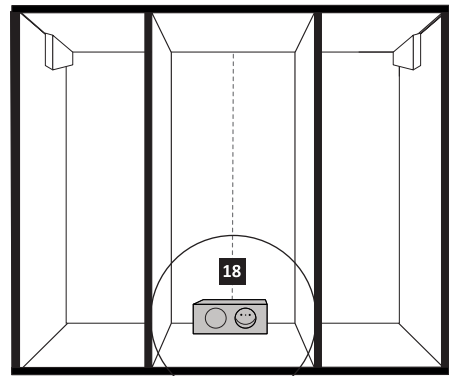
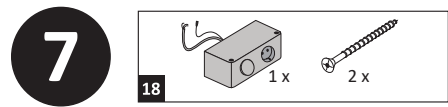

Achtung !!
Die Distanzhülsen sind optional im Lieferumfang.
Nur bei Bedarf nutzen.

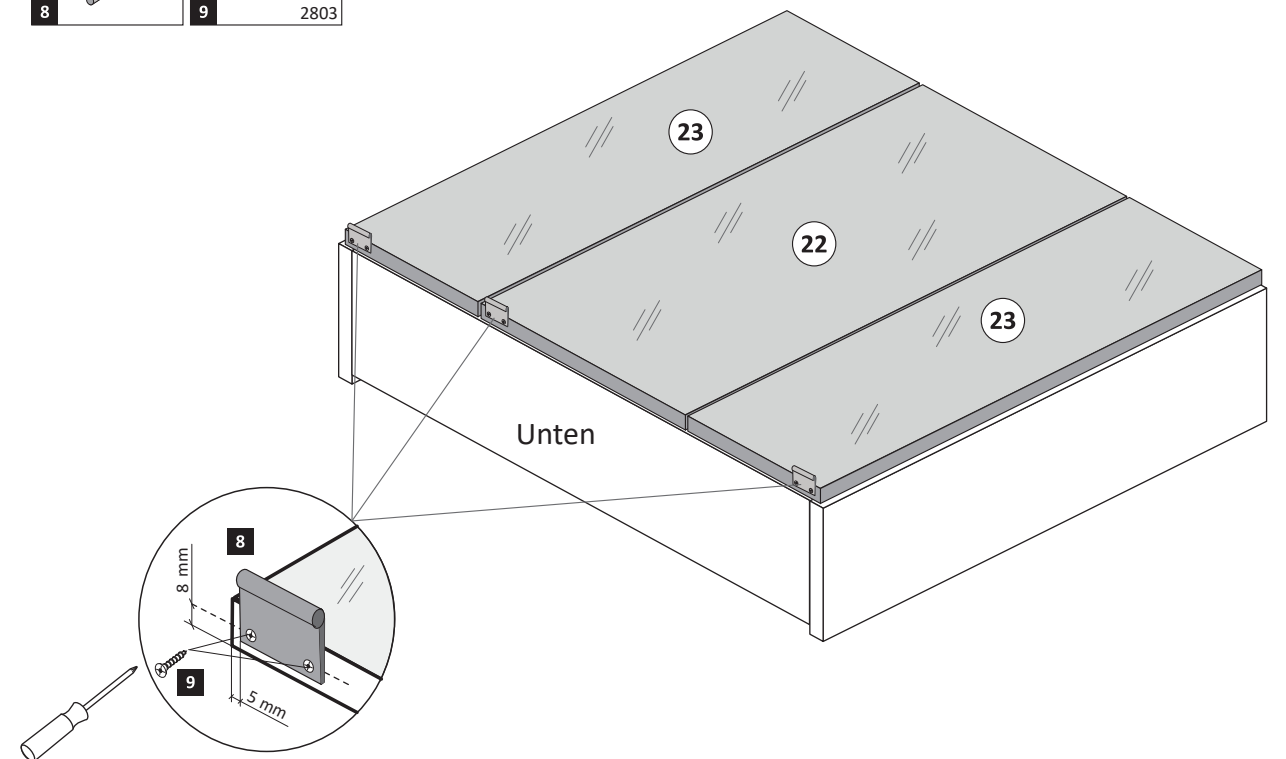
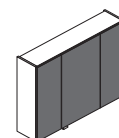
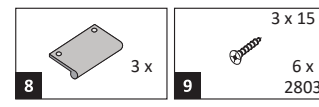
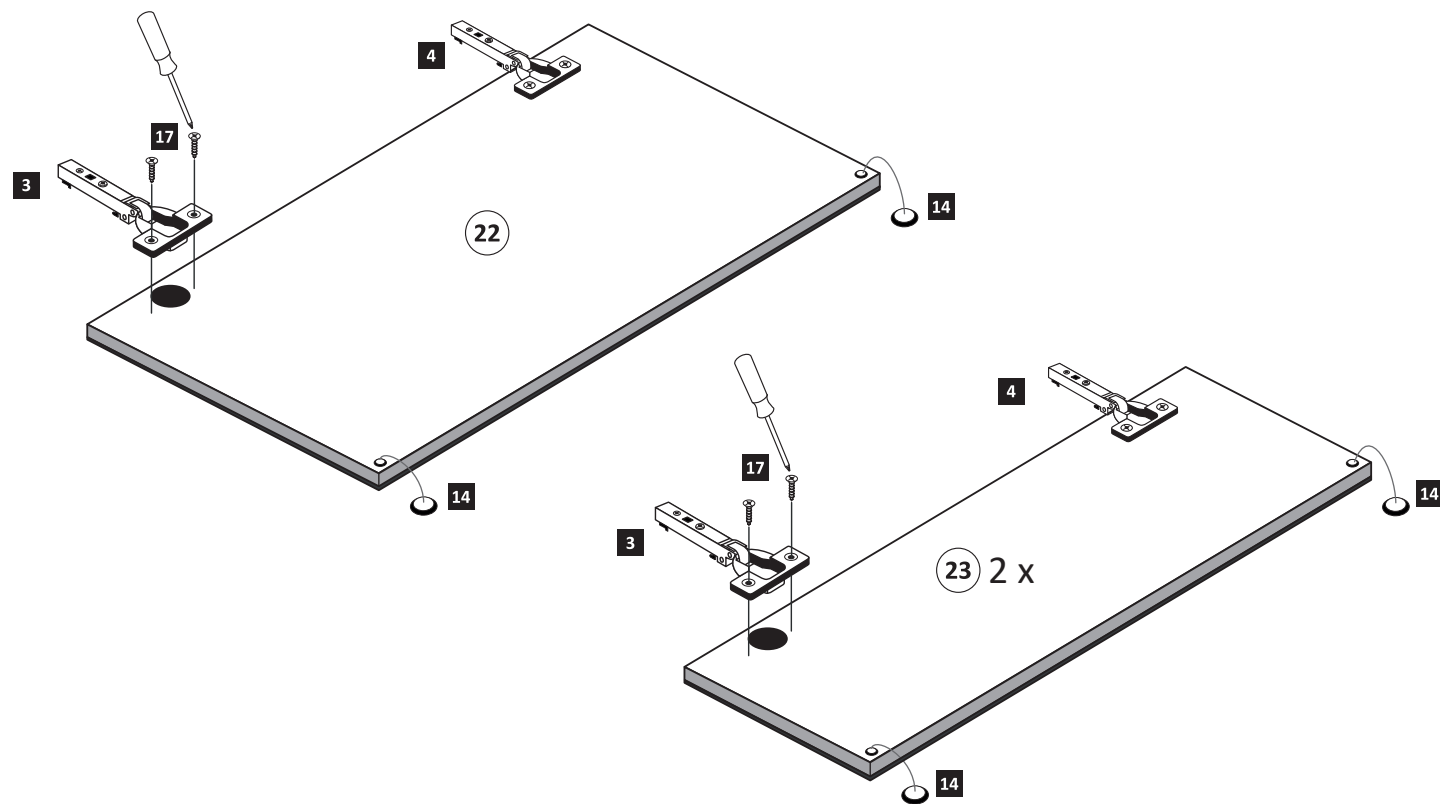
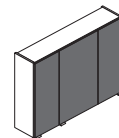
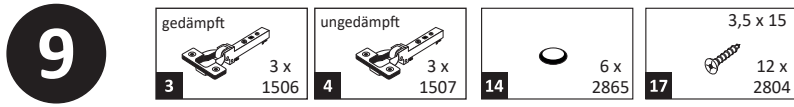
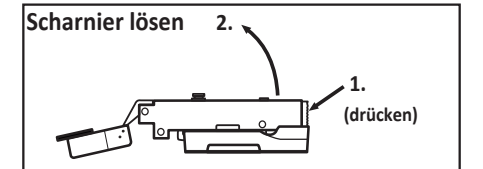
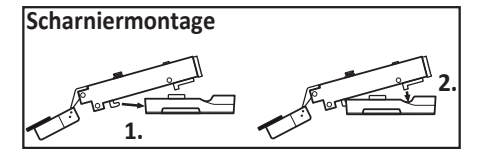
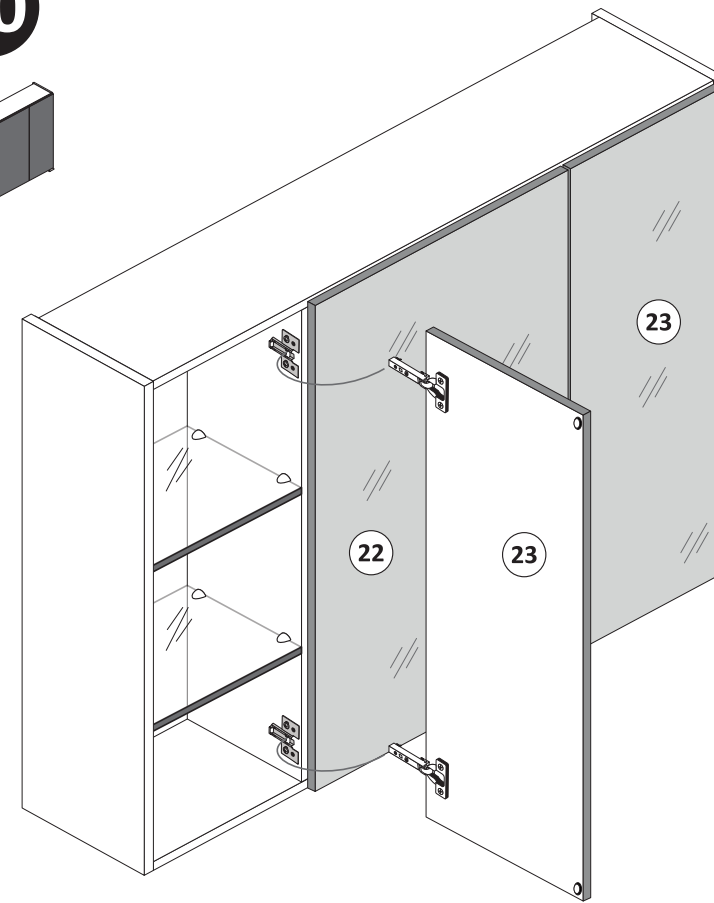
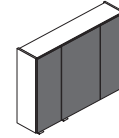
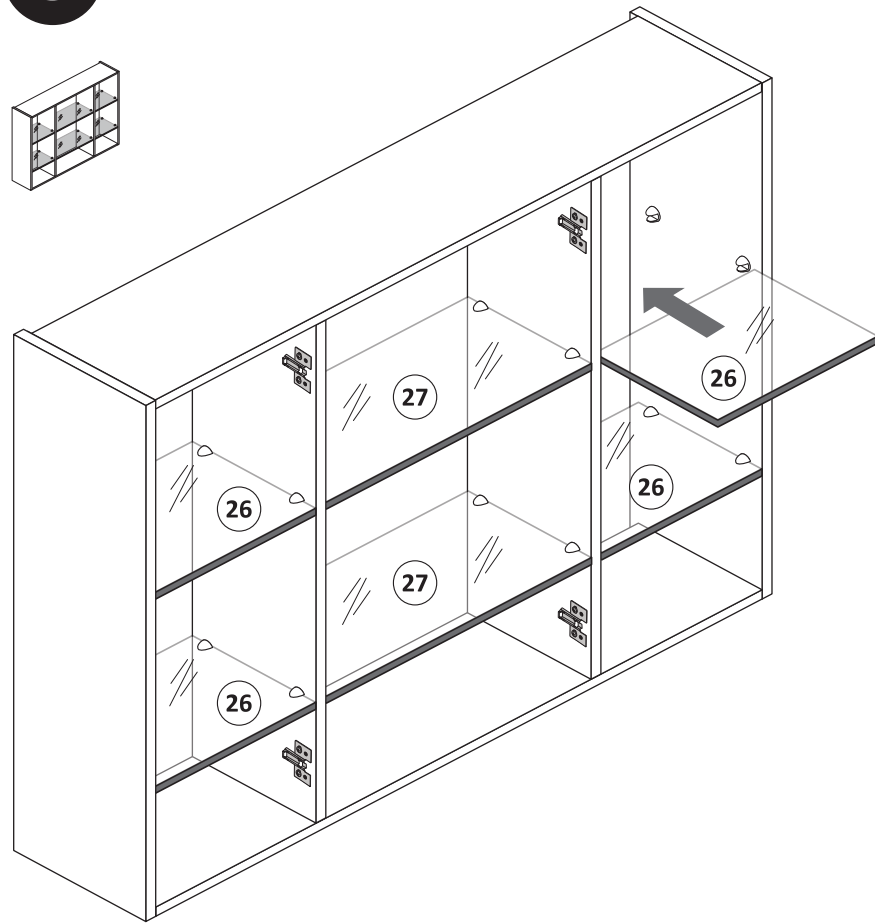
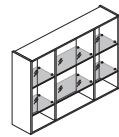

12

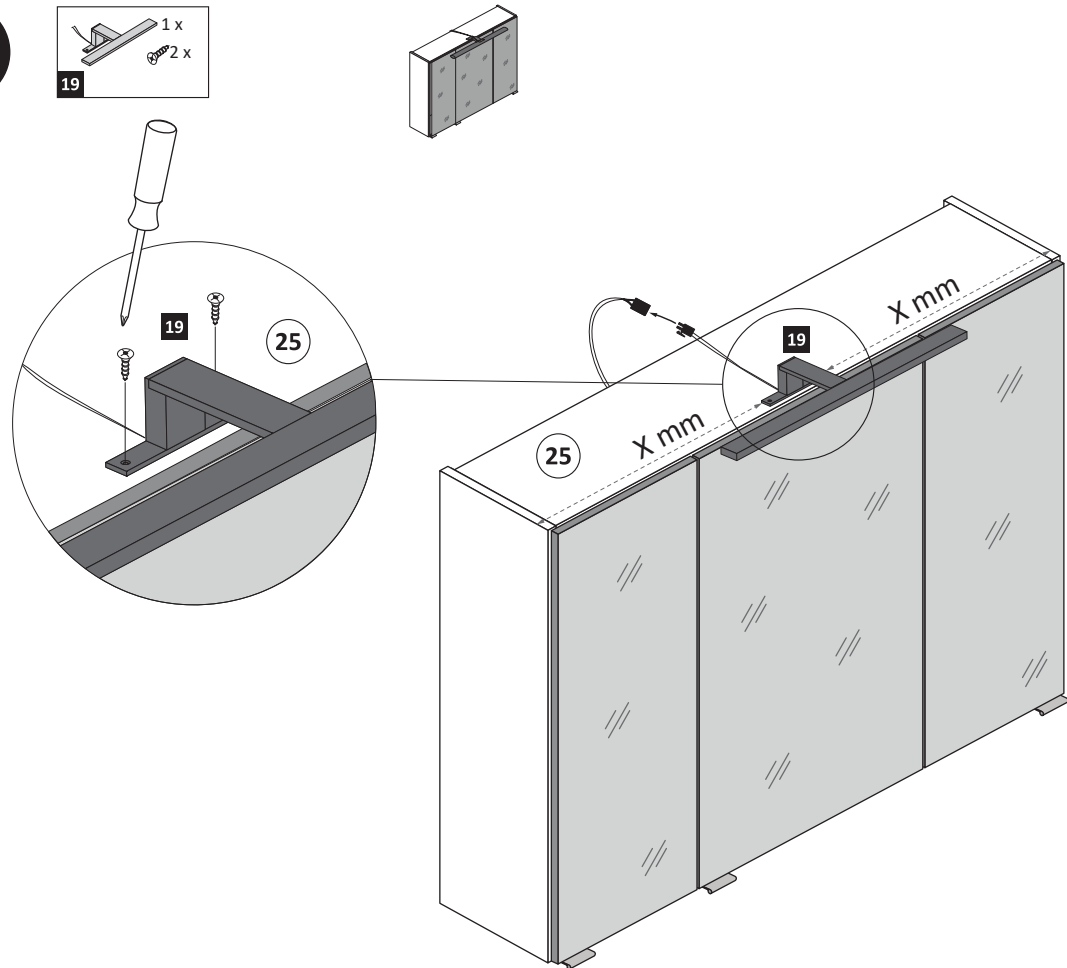

13

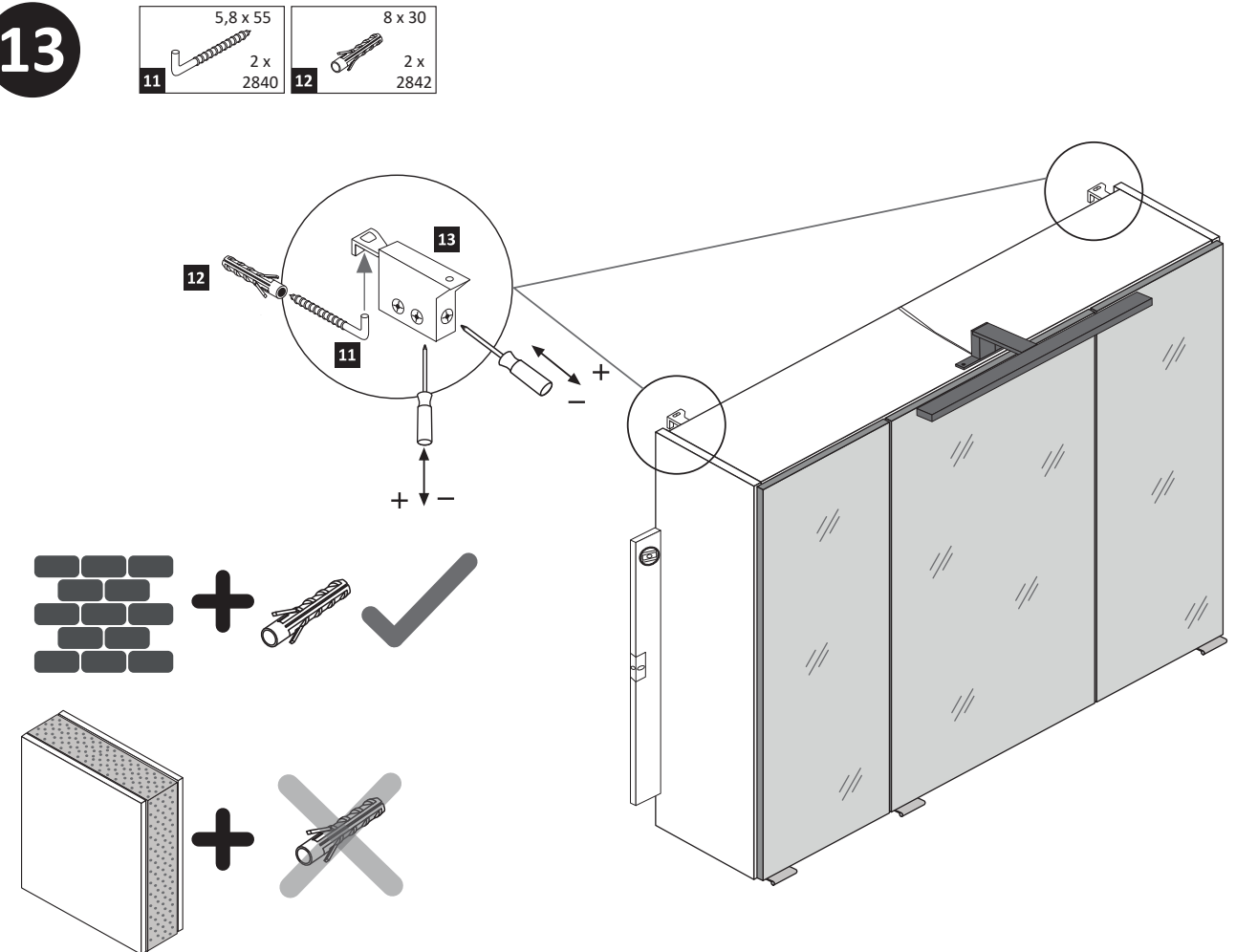

14

3,5 x 15
12 x
2804

1. Türen einstellen.

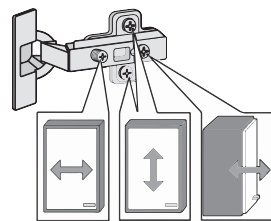

Achtung !!
Aus Sicherheitsgründen ist die Montage der Sicherungsschrauben zwingend notwendig. Nachdem montieren der Sicherungsschrauben ist die Höheneinstellung der Türen nicht mehr möglich!



2. Sicherungsschrauben montieren.

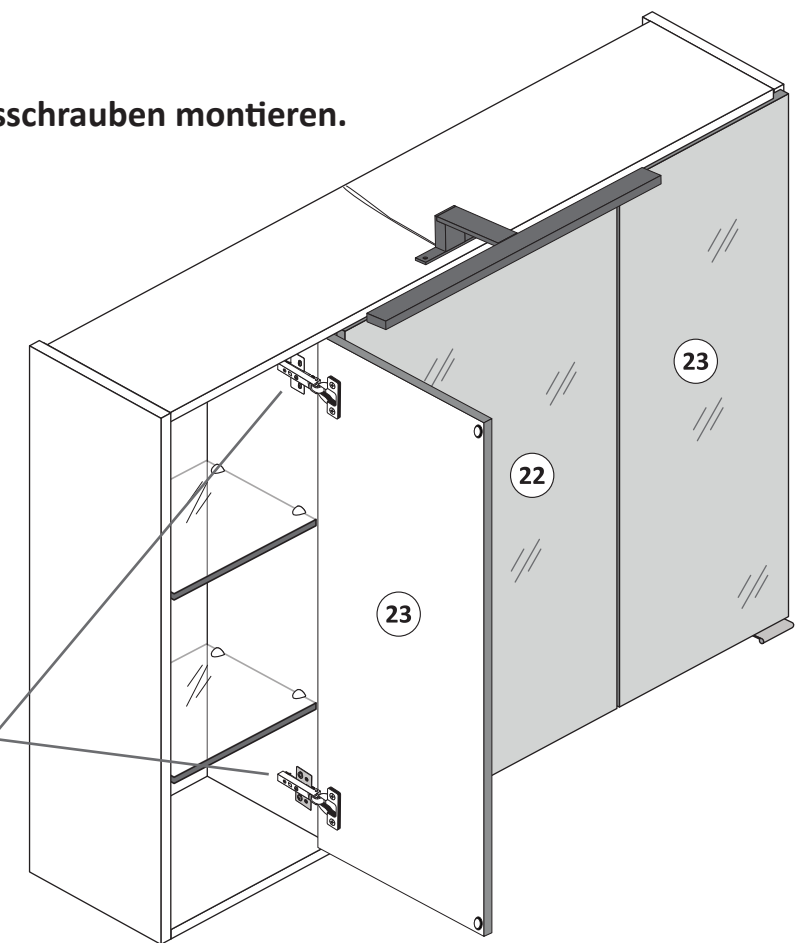
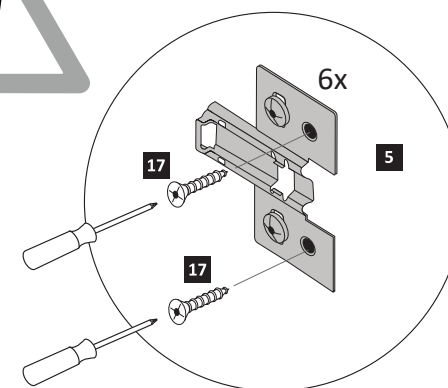
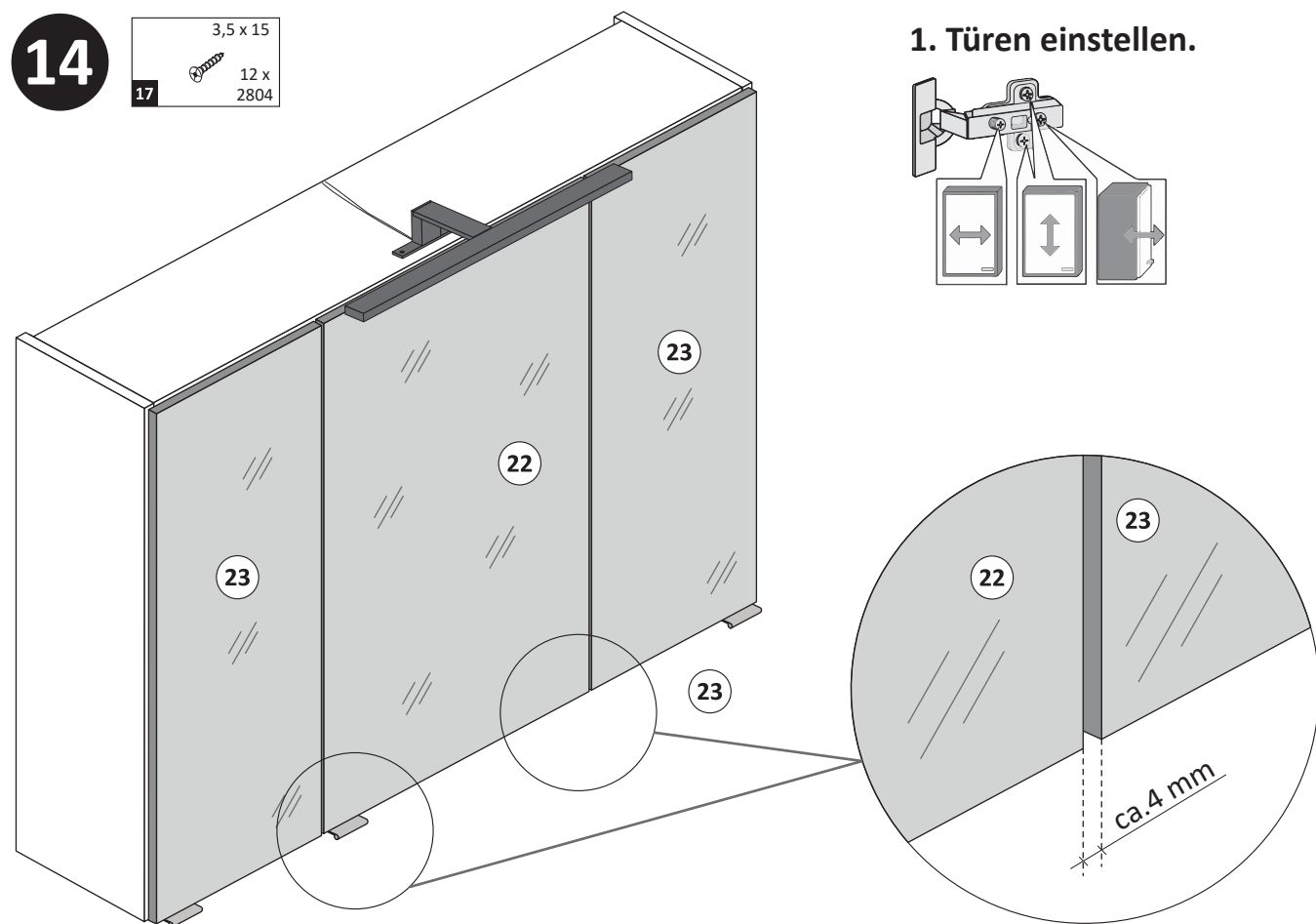



88085.532

1 4 x 2802	2 4 x 2801	gedämpft 3 x 1506	ungedämpft 3 x 1507	6 x 1614
6 24 x 2819	7 25 x 2862	8 3 x	3 x 15 6 x 2803	4 x 30 4 x 2812
5,8 x 55 2 x 2840	8 x 30 2 x 2842	13 2 x 2843	6 x 2865	8 x 30 16 x 2861
Leim 1 x 2863	3,5 x 15 26 x 2804	18 1 x 2 x	19 1 x 2 x	

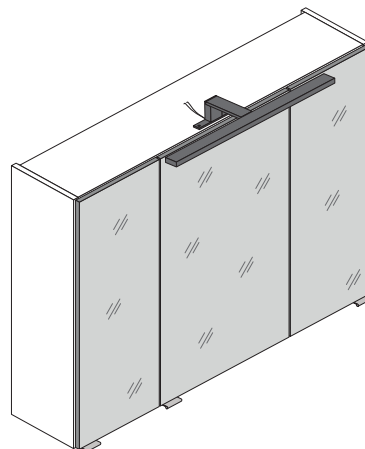
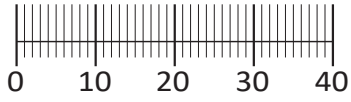
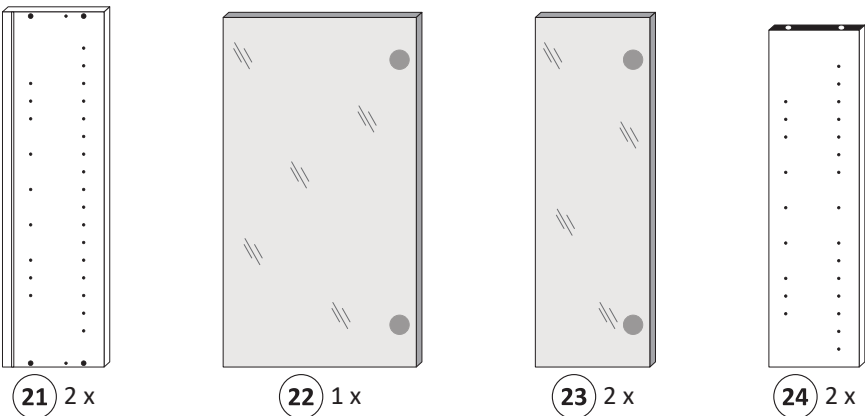

3D-Effekt

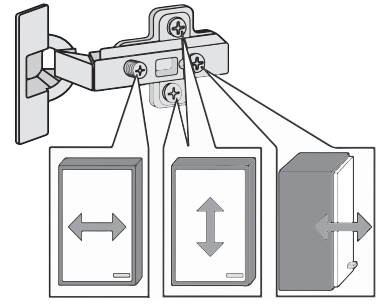
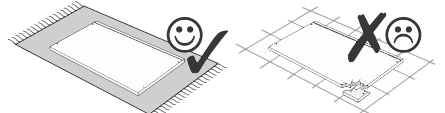
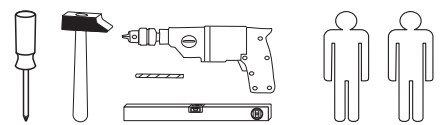
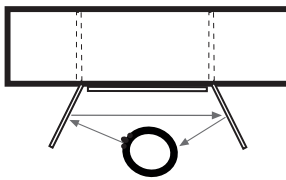

Held Möbel GmbH
Vogelparadies 9
32457 Porta Westfalica

Mail:
info@held-moebel.de



Diese Aufbauanleitung muss bis zum Ende der Nutzungszeit ihres Produktes sorgfältig aufbewahrt werden! Im Rahmen des Produkthaftungsgesetzes müssen Sie die Herstellerkennzeichnung aufbewahren. Zusätzlich kann Ihnen die Aufbauanleitung bei Ersatzteilbestellungen helfen, Bauteile und Beschläge eindeutig zu identifizieren.

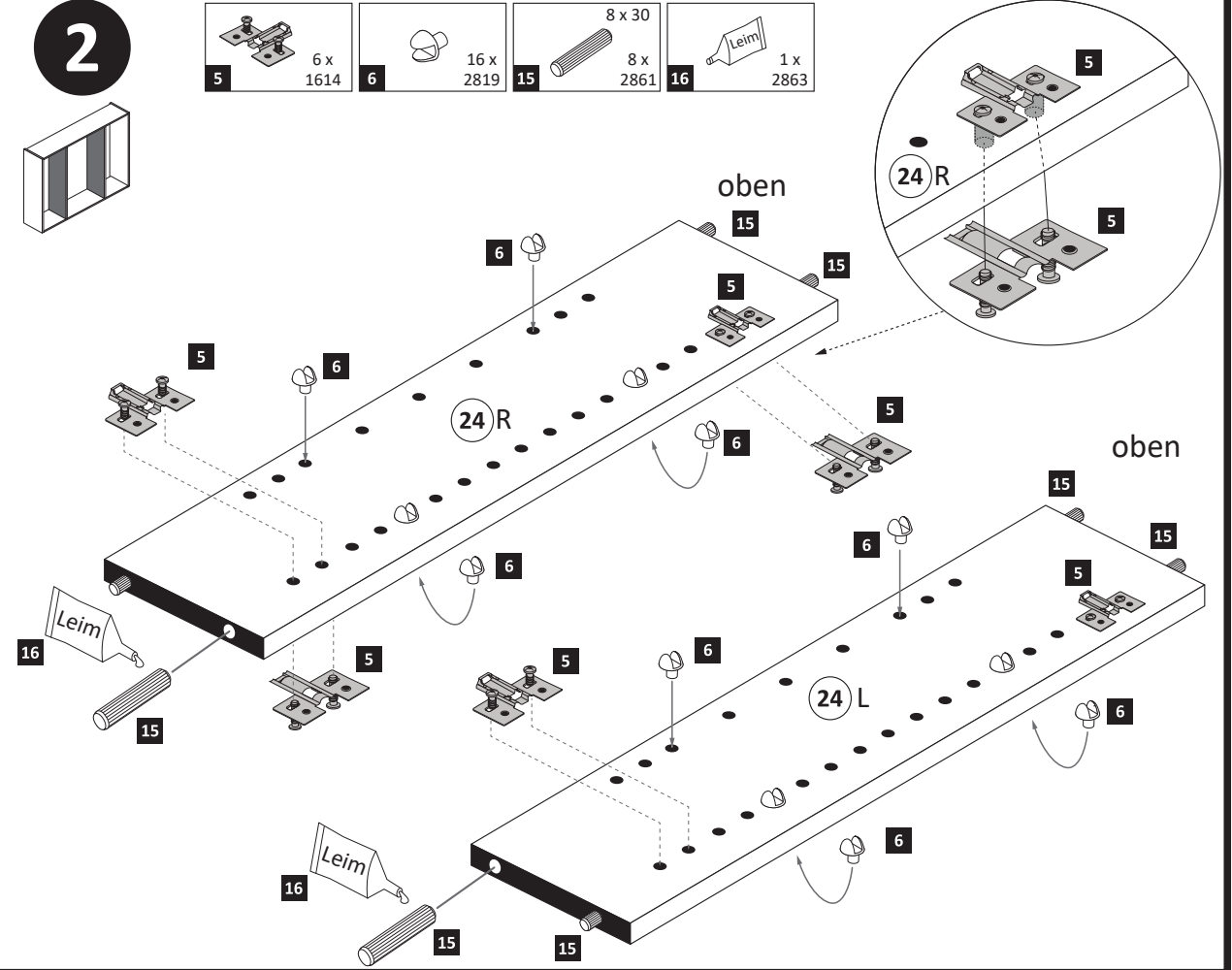
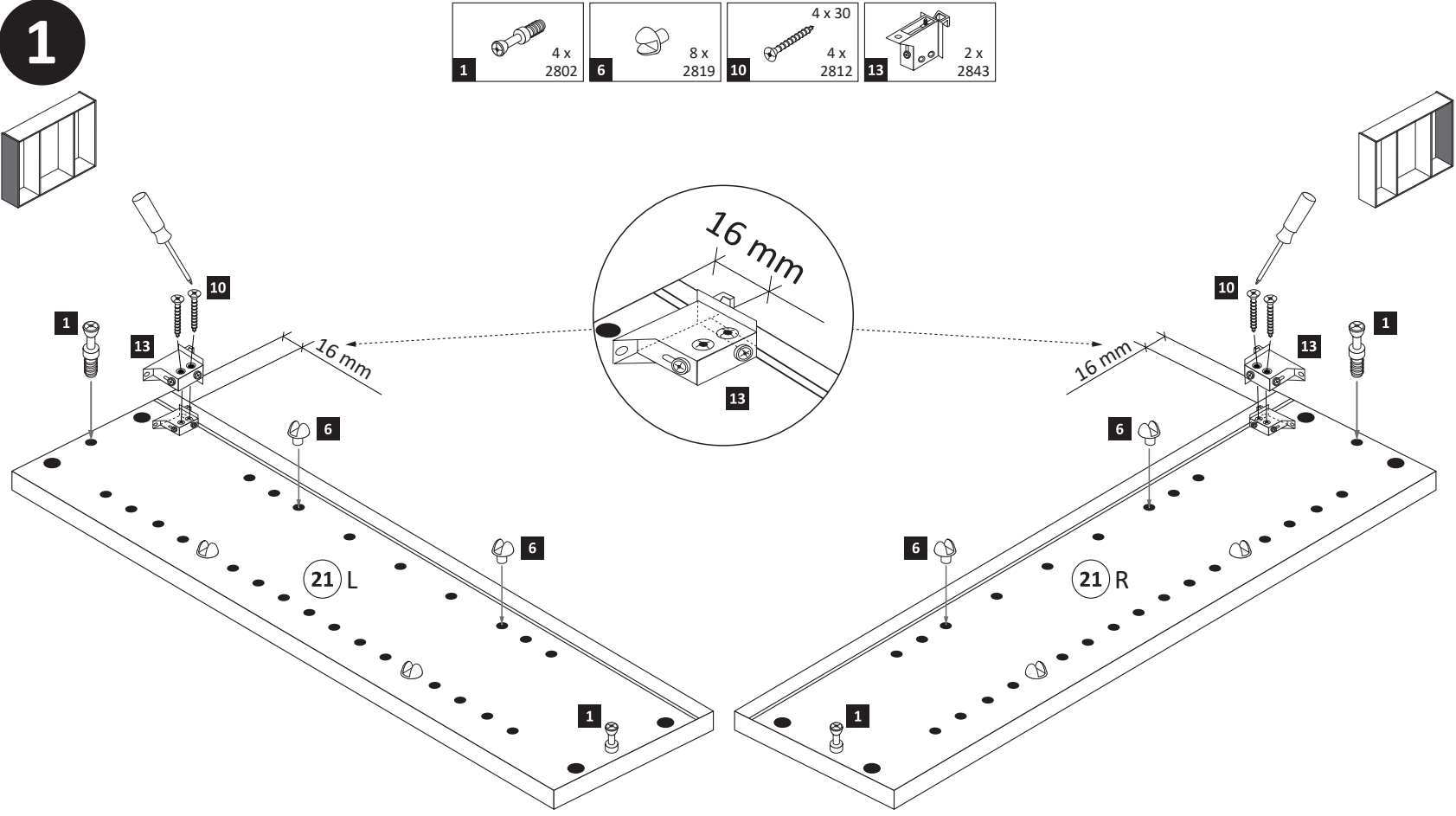
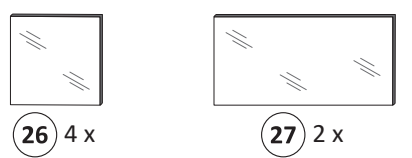
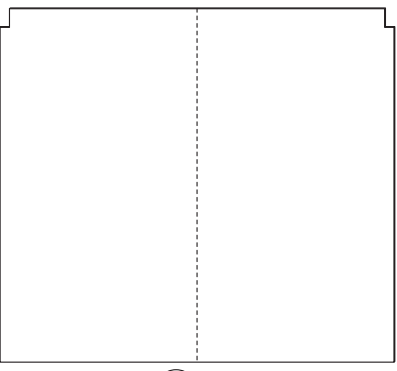
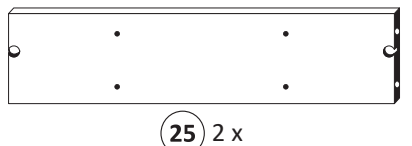

3

- 2 4 x 2801
- 15 8 x 30 8 x 2861
- 16 1 x 2863

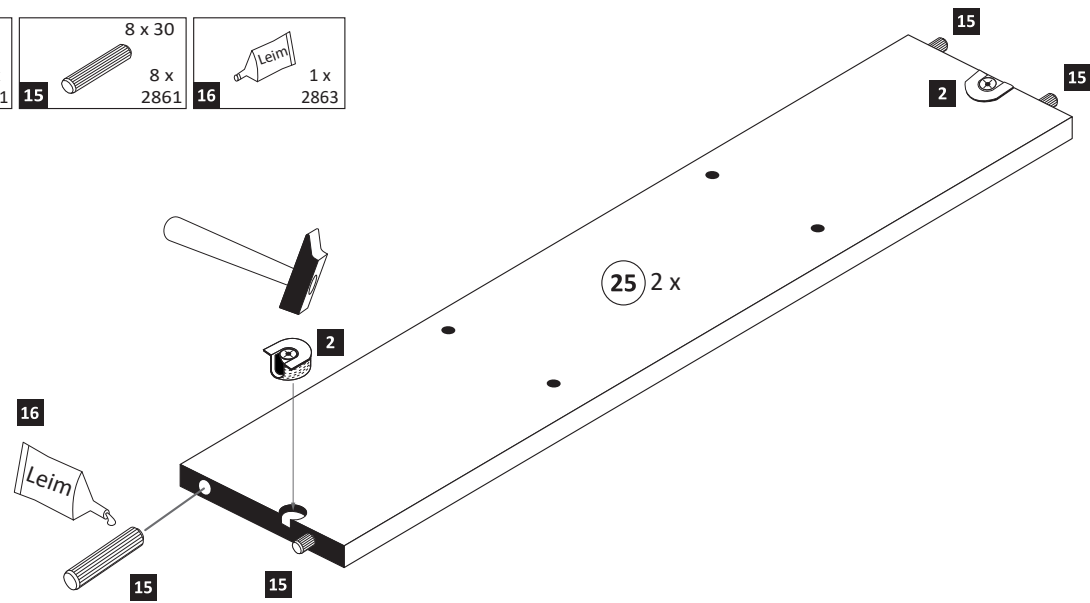

4

- 17 3,5 x 15 2 x 2804

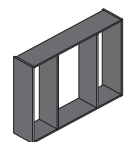

- 16 1 x 2863
 - D Leim
 - GB Glue
 - NL Lijm
 - PL Klej
 - TR Tutkal
 - F Colle
 - I Colla
- 20 min.

Ansicht von links

Ansicht von rechts

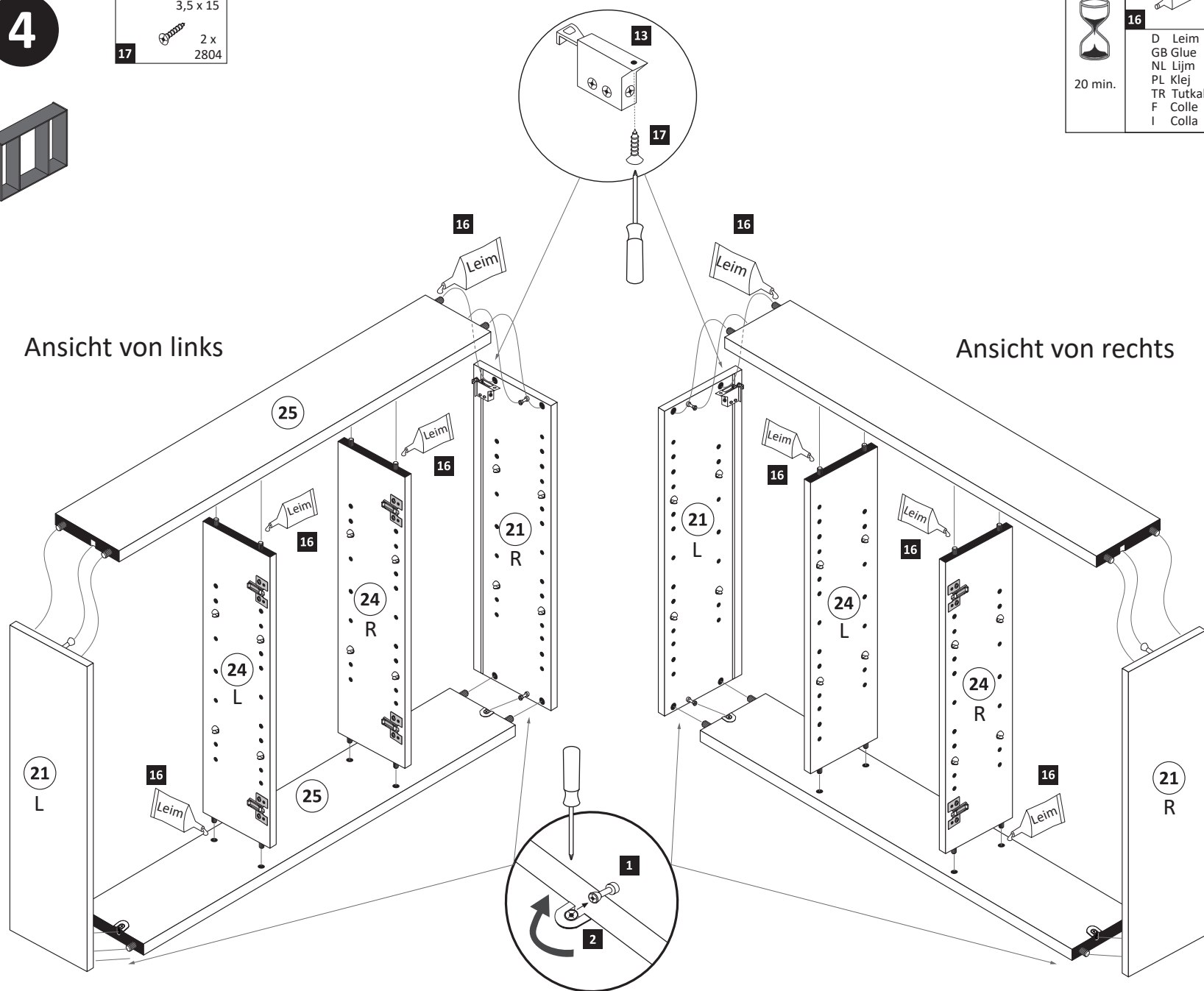

5

Bitte nur eine Variante auswählen und den entsprechenden Ausschnitt in einer Größe von maximal Trafobreite wie Trafohöhe - 10 mm aussägen. Trafomontage wird im Schritt 7 durchgeführt.

Variante 1: Trafomontage unten

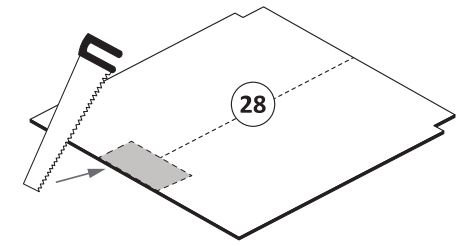
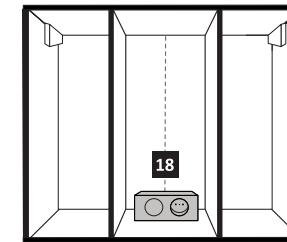

Variante 2: Trafomontage oben

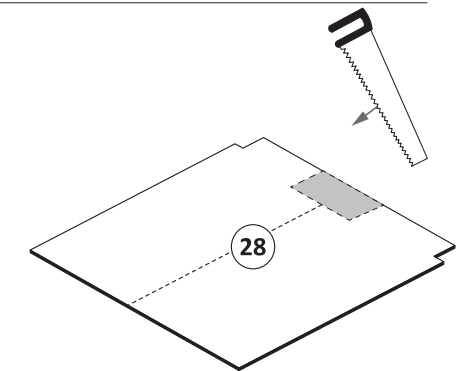
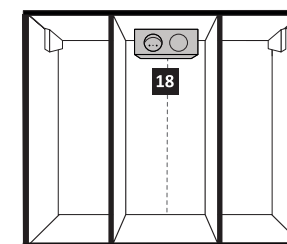

6

- 7 25 x 2862

ACHTUNG!
Folgende Montageschritte mit dem Beispiel „Trafomontage Variante unten links“!

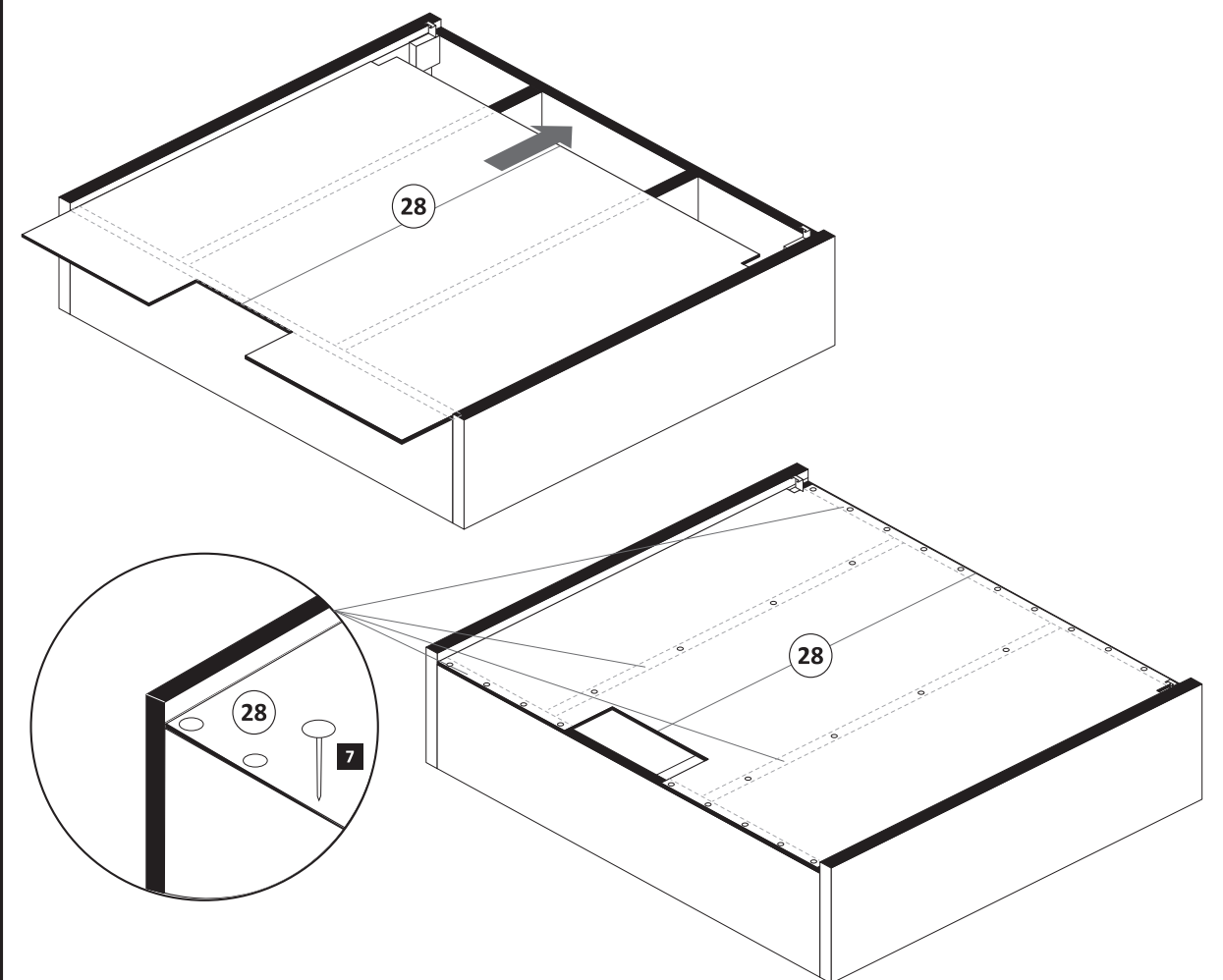

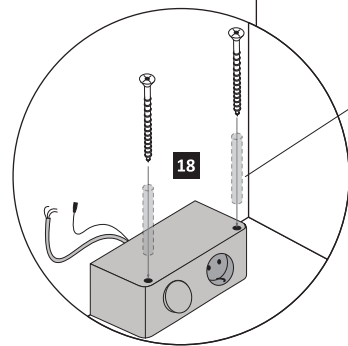
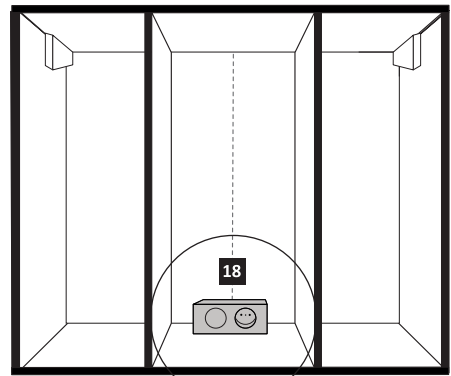
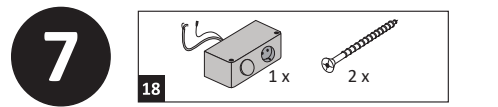

Achtung !!
Die Distanzhülsen sind optional im Lieferumfang.
Nur bei Bedarf nutzen.

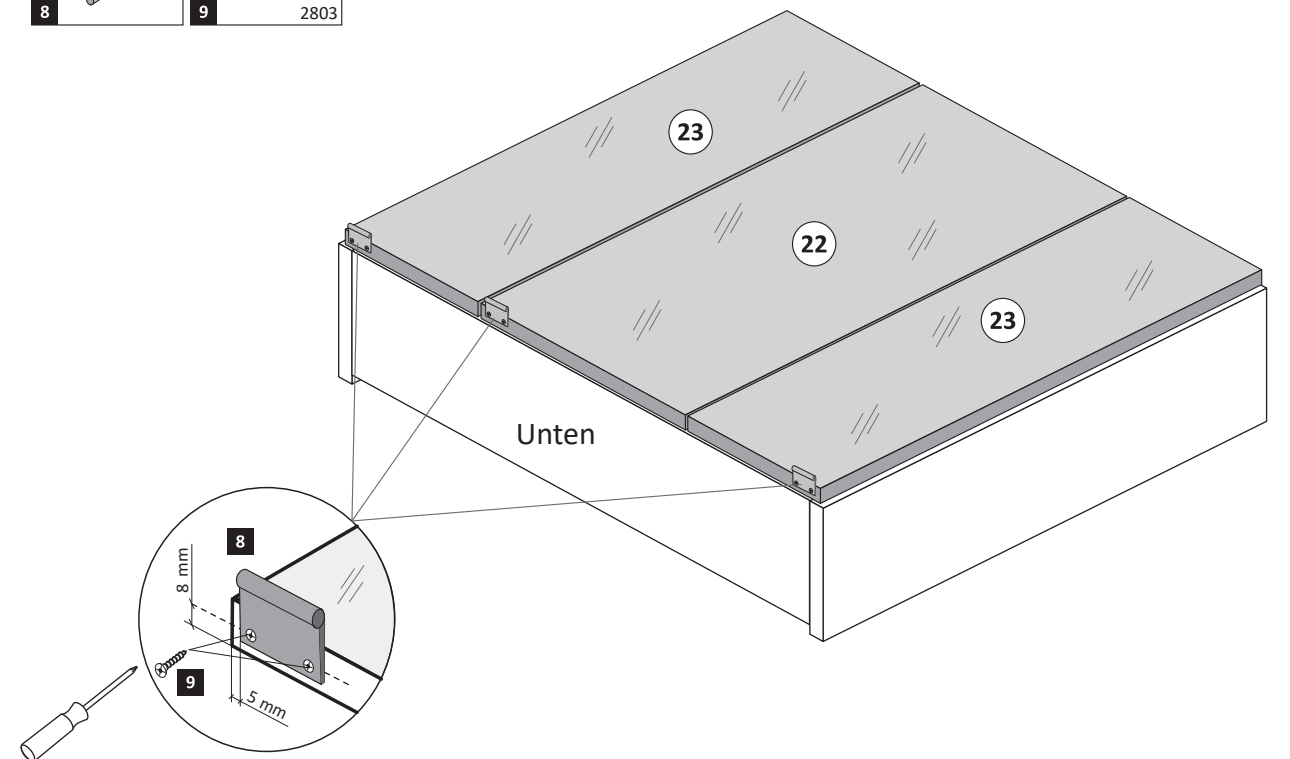
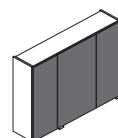
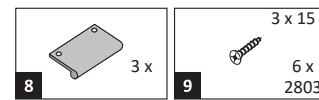
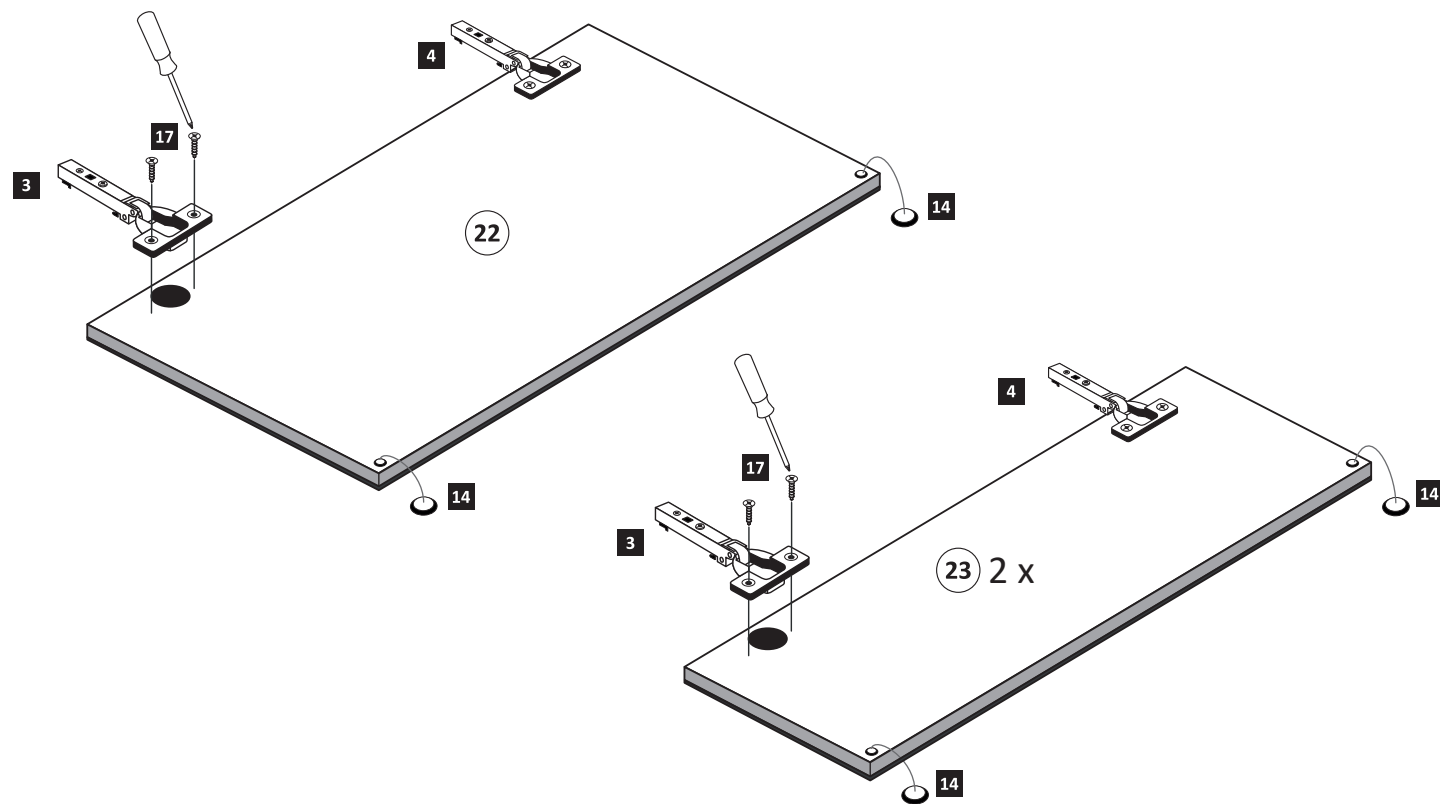
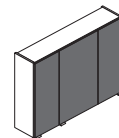
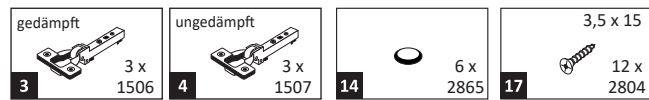
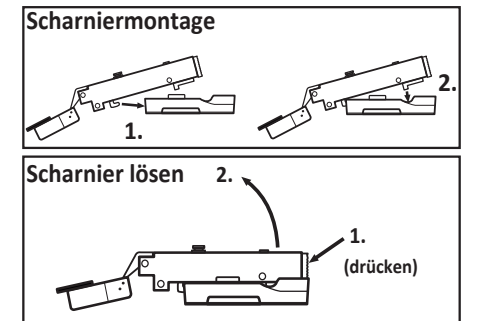
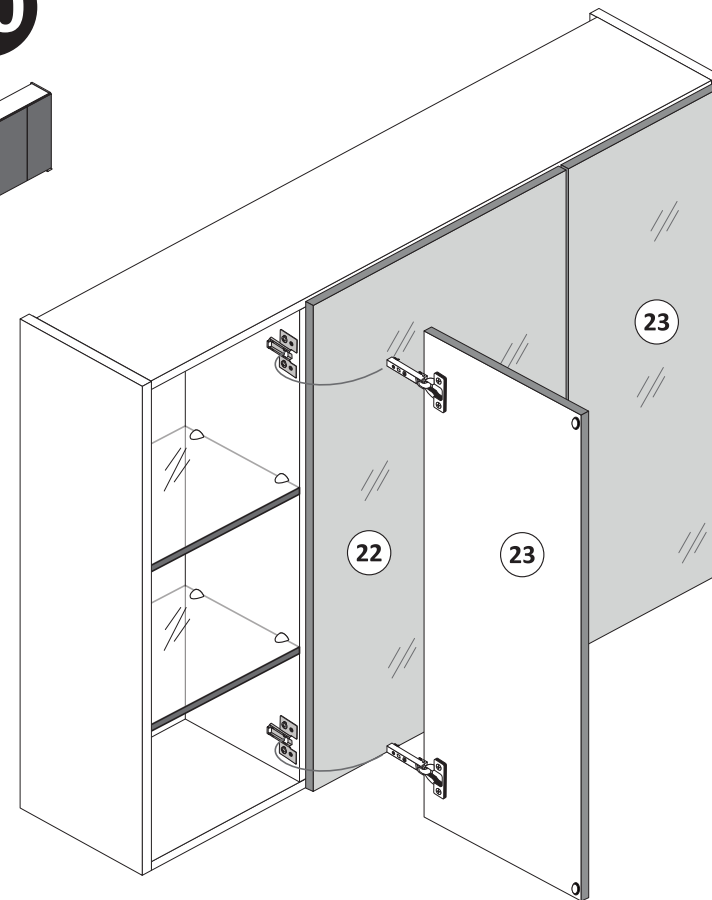
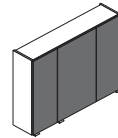
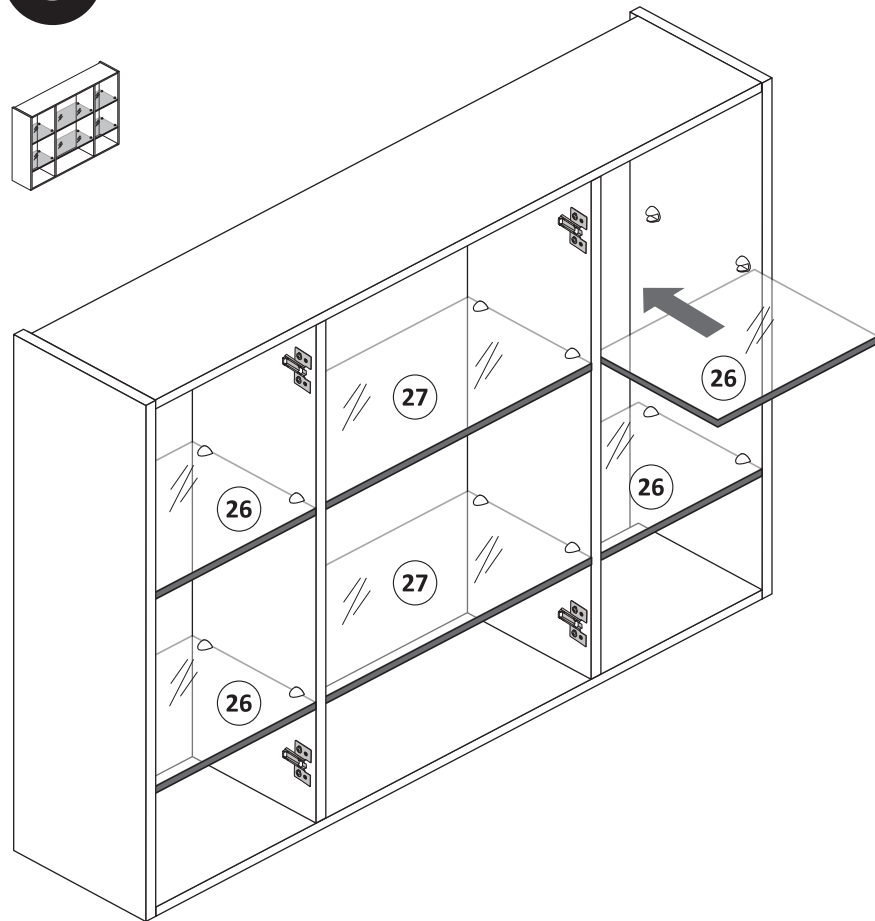
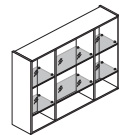

12

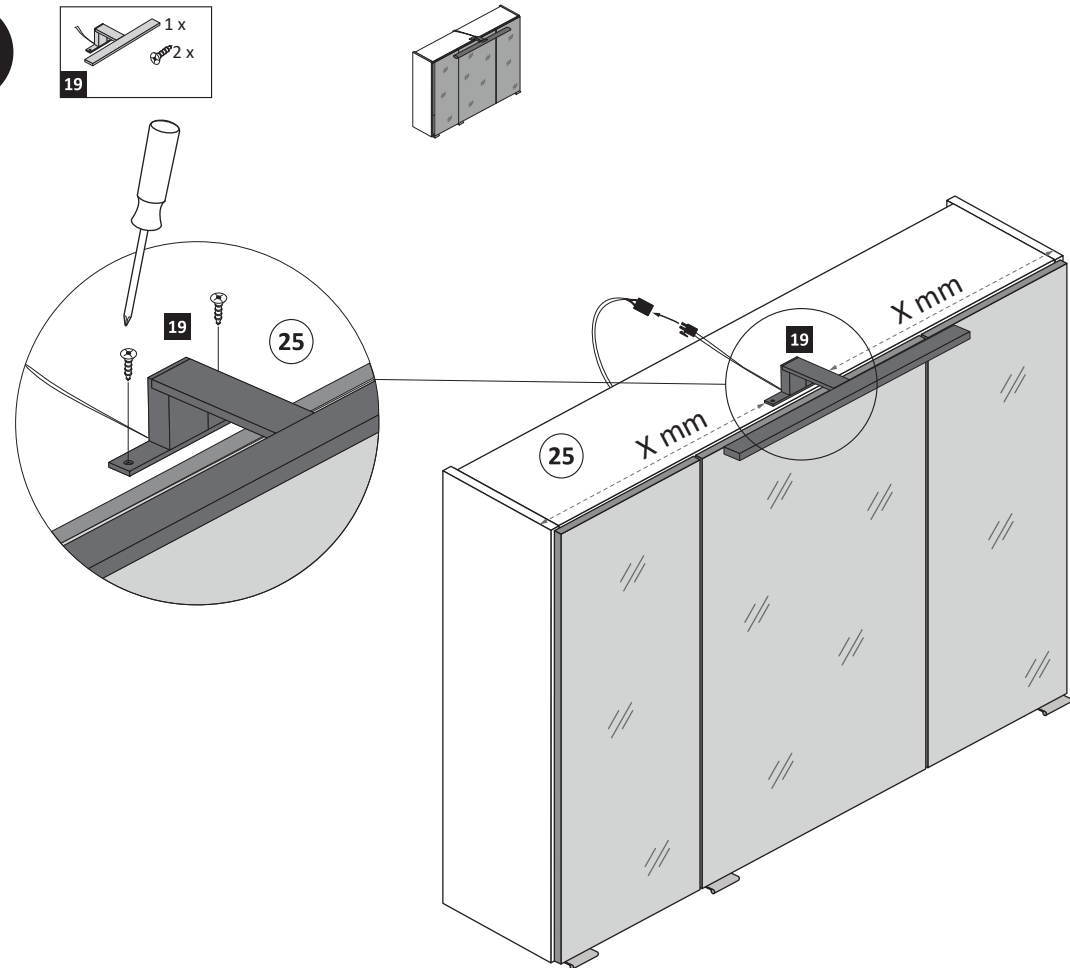

13

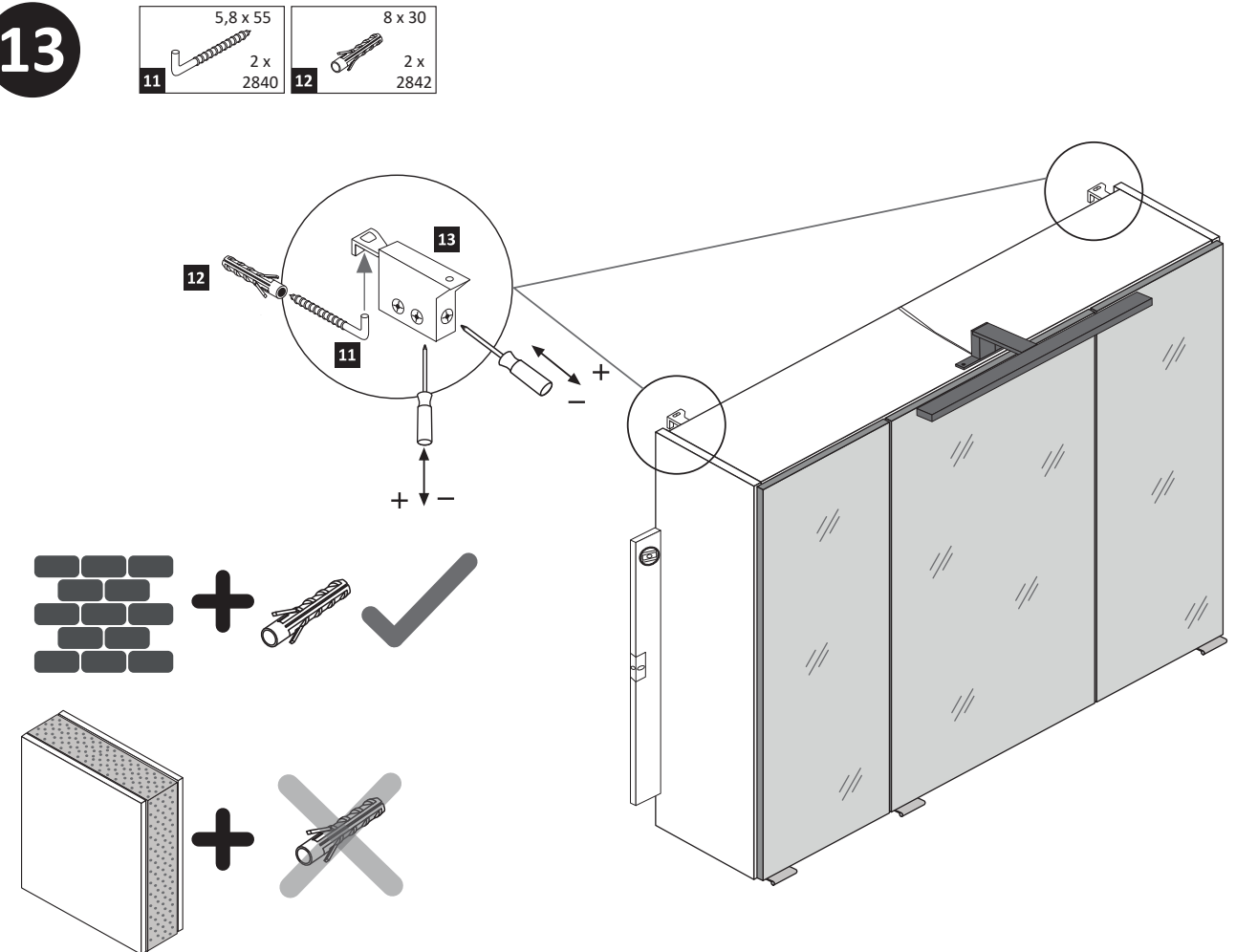

14

3,5 x 15
12 x 2804
17

1. Türen einstellen.

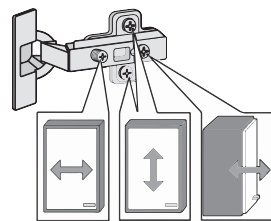

Achtung !!
Aus Sicherheitsgründen ist die Montage der Sicherungsschrauben zwingend notwendig. Nachdem montieren der Sicherungsschrauben ist die Höheneinstellung der Türen nicht mehr möglich!



2. Sicherungsschrauben montieren.

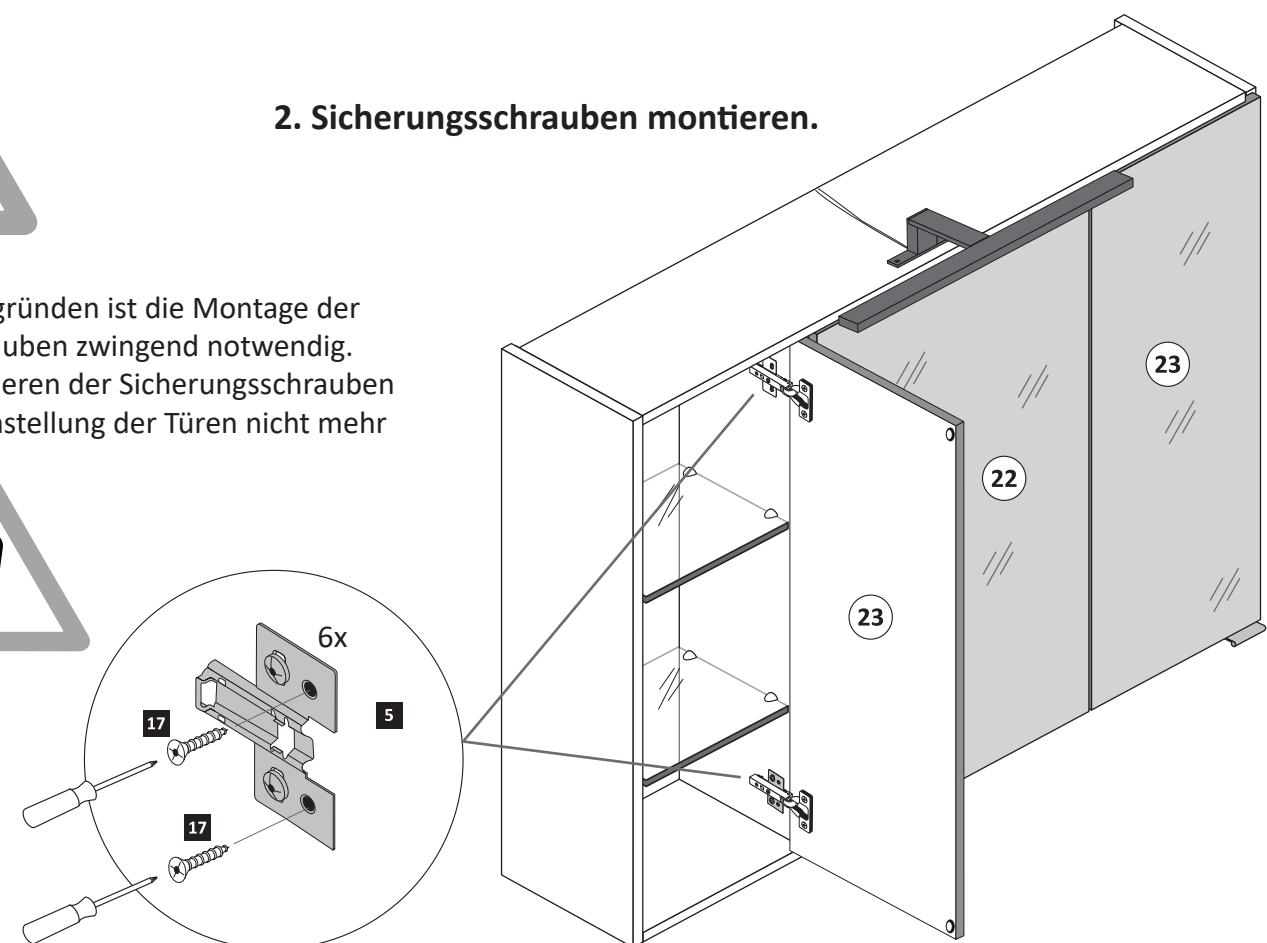
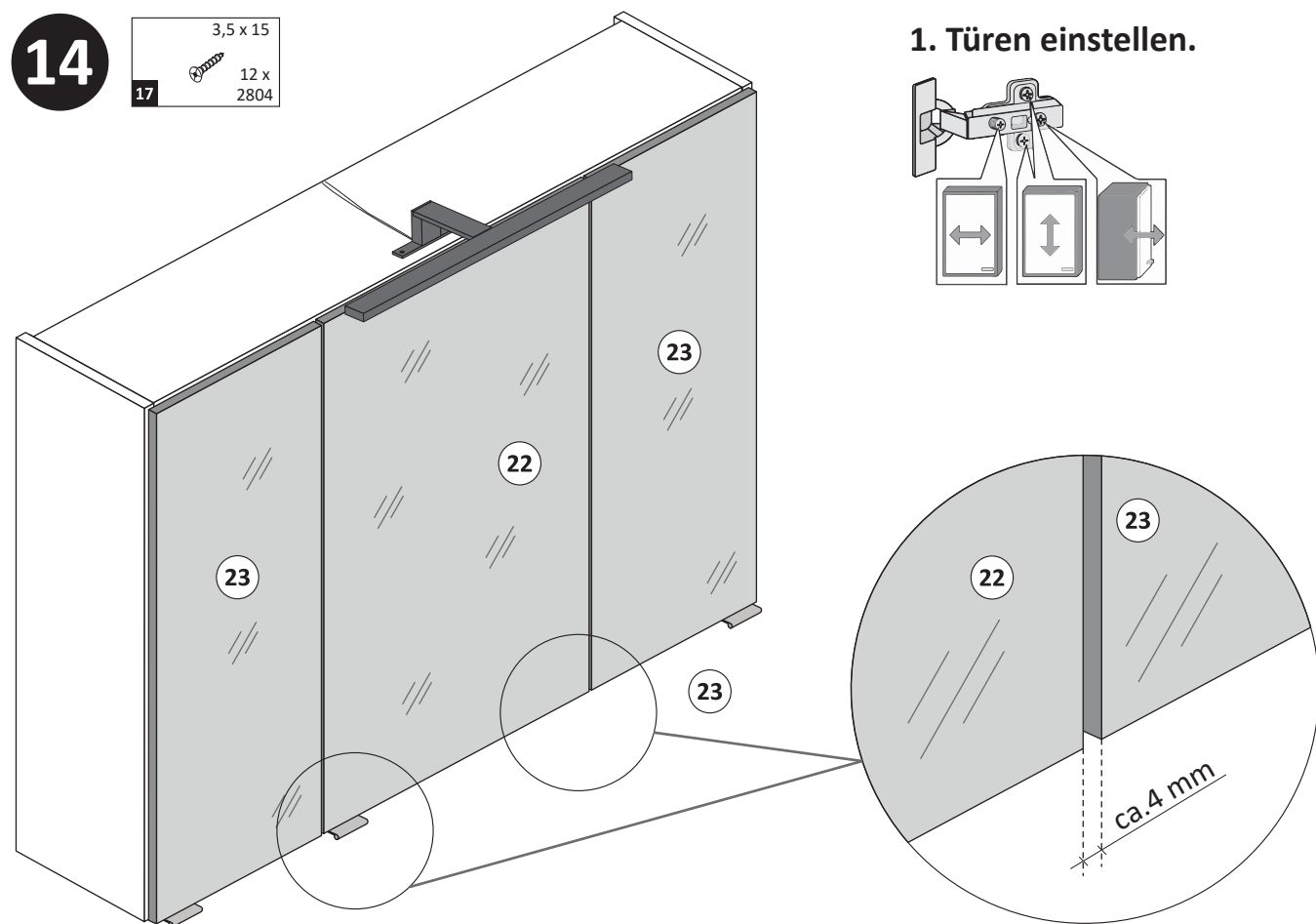



88085.532

1 4 x 2802	2 4 x 2801	gedämpft 3 x 1506	ungedämpft 3 x 1507	6 x 1614
6 24 x 2819	7 25 x 2862	8 3 x	3 x 15 6 x 2803	4 x 30 4 x 2812
5,8 x 55 2 x 2840	8 x 30 2 x 2842	13 2 x 2843	6 x 2865	8 x 30 16 x 2861
Leim 1 x 2863	3,5 x 15 26 x 2804	18 1 x 2 x	19 1 x 2 x	

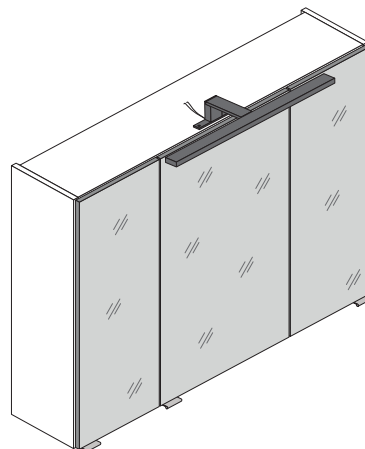
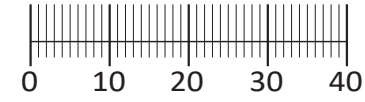
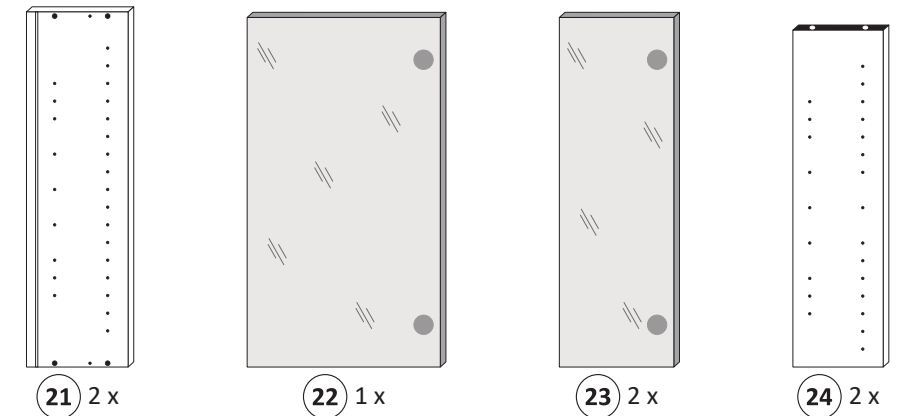

3D-Effekt

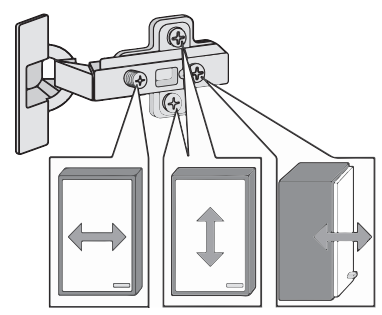
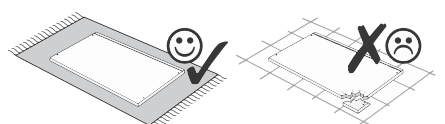
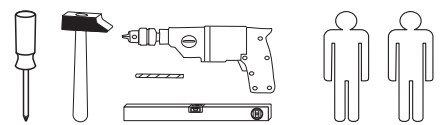
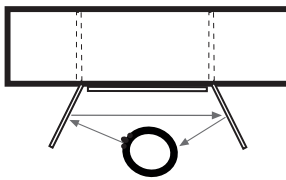

Held Möbel GmbH
Vogelparadies 9
32457 Porta Westfalica

Mail:
info@held-moebel.de



Diese Aufbauanleitung muss bis zum Ende der Nutzungszeit ihres Produktes sorgfältig aufbewahrt werden! Im Rahmen des Produkthaftungsgesetzes müssen Sie die Herstellerkennzeichnung aufbewahren. Zusätzlich kann Ihnen die Aufbauanleitung bei Ersatzteilbestellungen helfen, Bauteile und Beschläge eindeutig zu identifizieren.

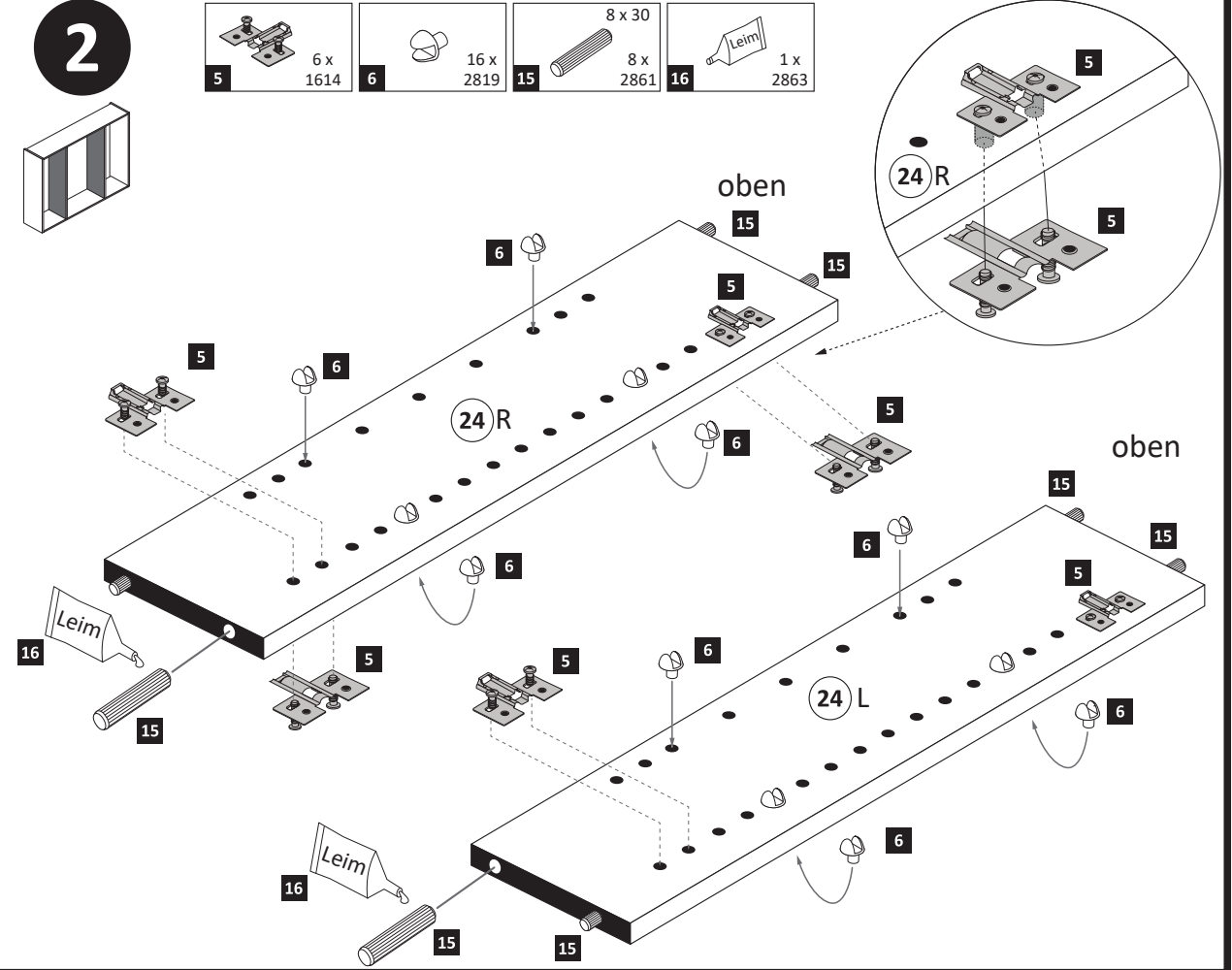
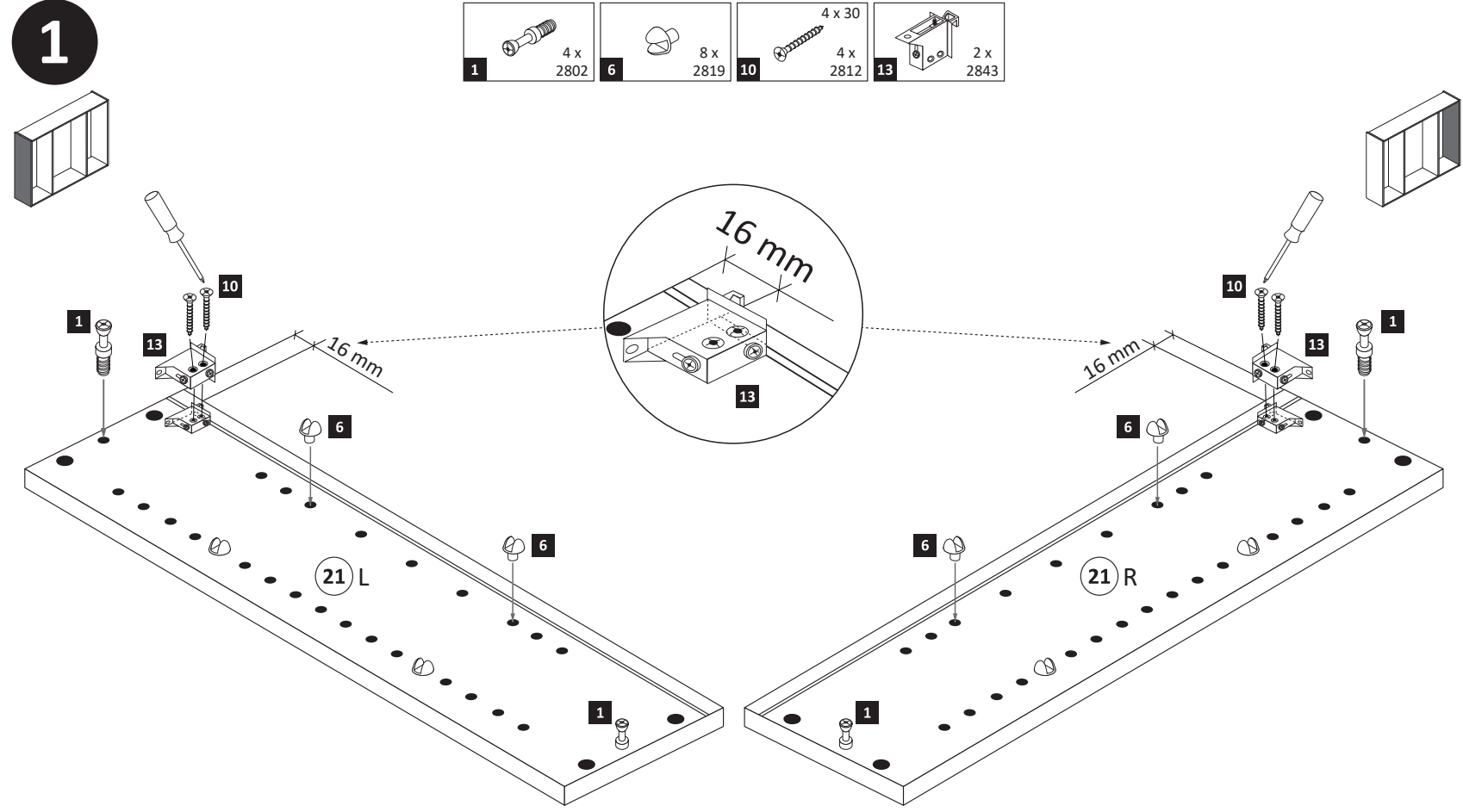
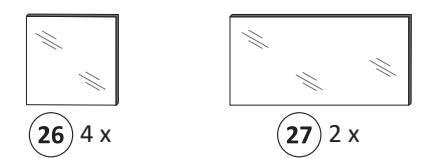
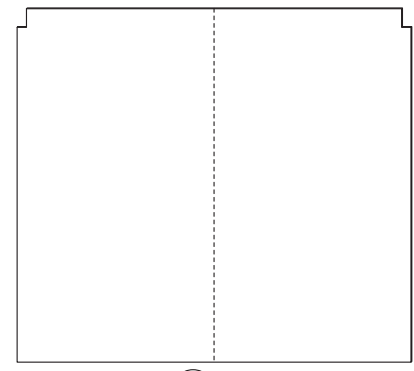
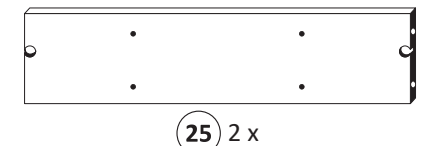

3

- 2 4 x 2801
- 15 8 x 30 8 x 2861
- 16 1 x 2863

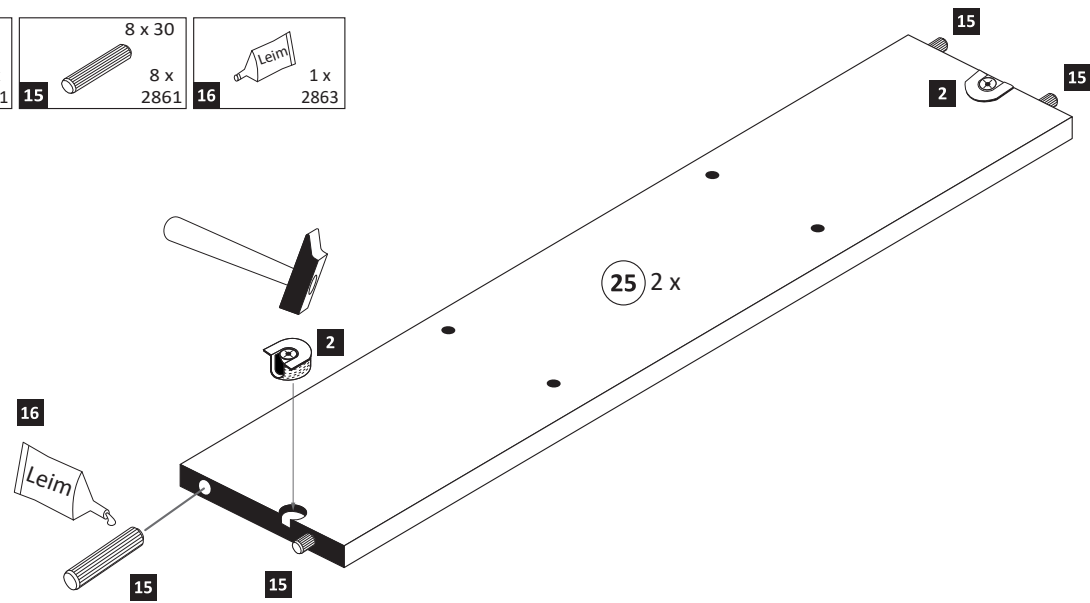

4

- 17 3,5 x 15 2 x 2804

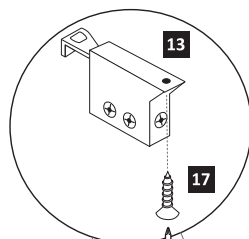
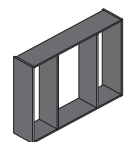

- 16 1 x 2863
- 20 min.
- D Leim
 - GB Glue
 - NL Lijm
 - PL Klej
 - TR Tutkal
 - F Colle
 - I Colla

Ansicht von links

Ansicht von rechts

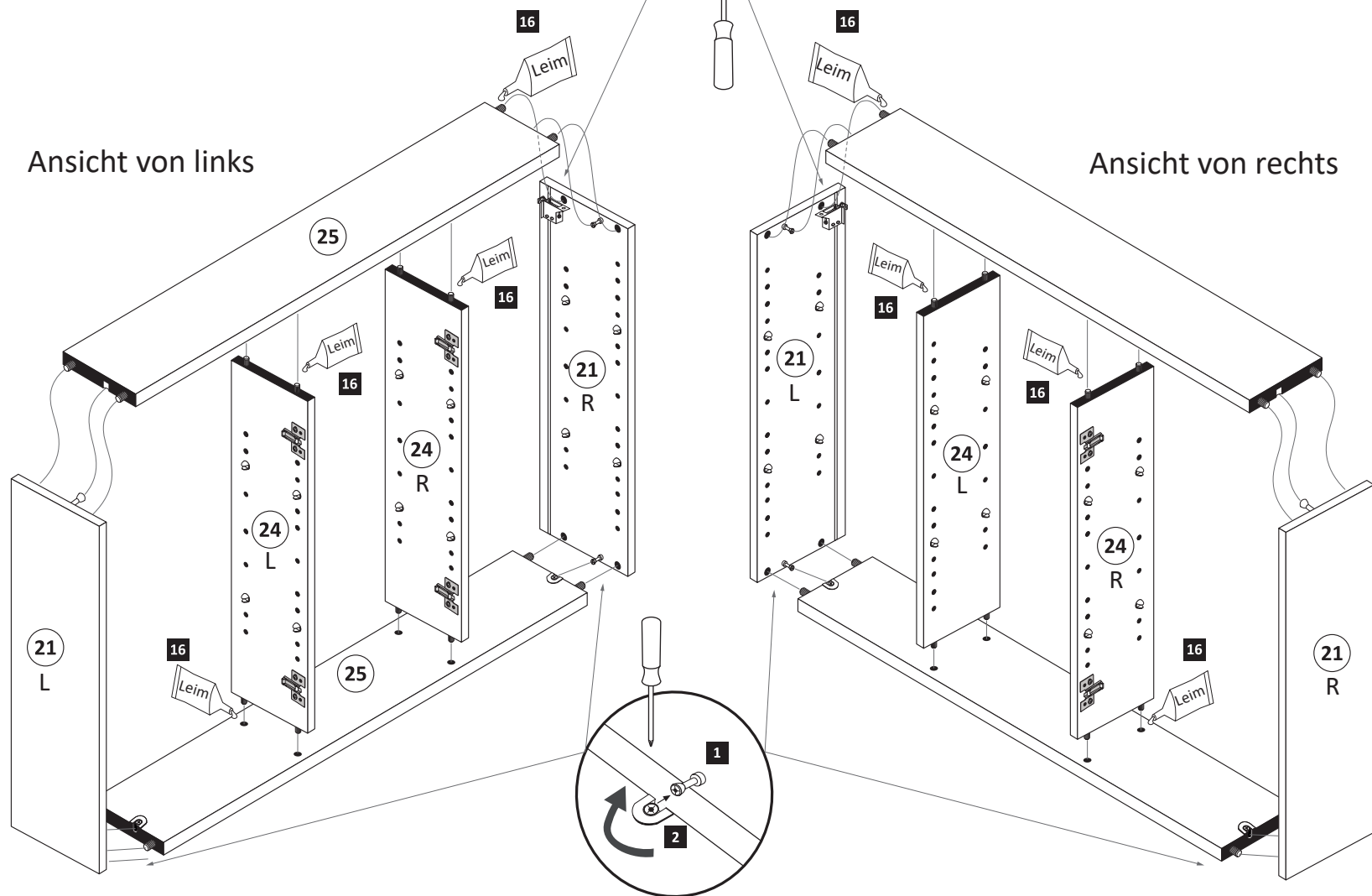

5

Bitte nur eine Variante auswählen und den entsprechenden Ausschnitt in einer Größe von maximal Trafobreite wie Trafohöhe - 10 mm aussägen. Trafomontage wird im Schritt 7 durchgeführt.

Variante 1: Trafomontage unten

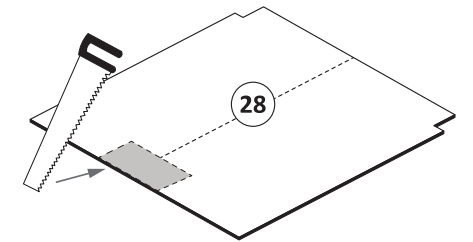
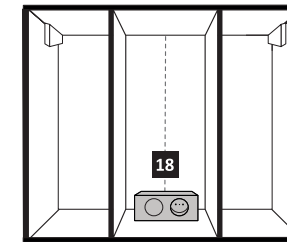

Variante 2: Trafomontage oben

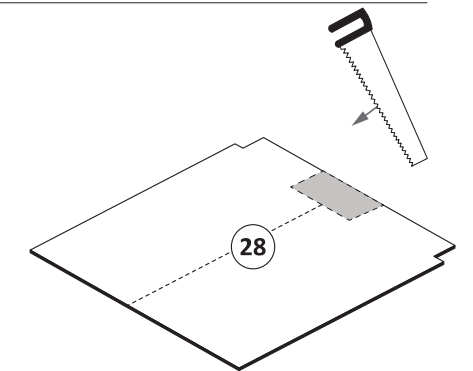
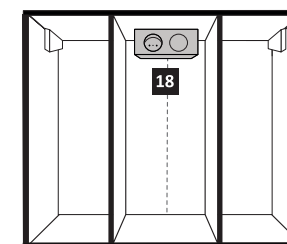

6

- 7 25 x 2862

ACHTUNG!
Folgende Montageschritte mit dem Beispiel „Trafomontage Variante unten links“!

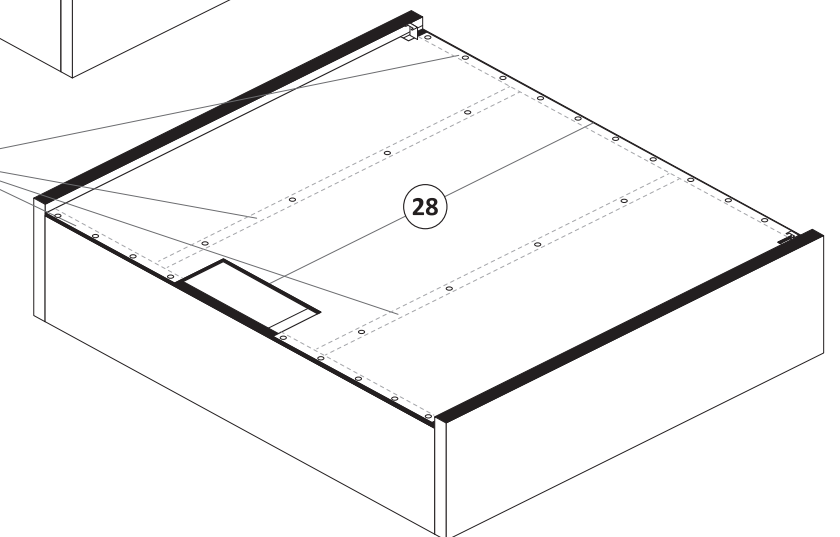
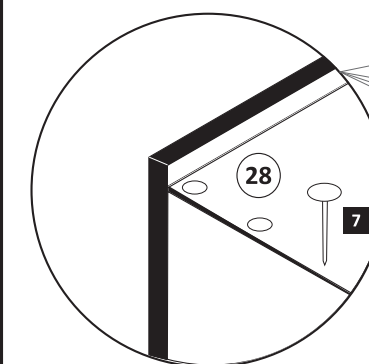
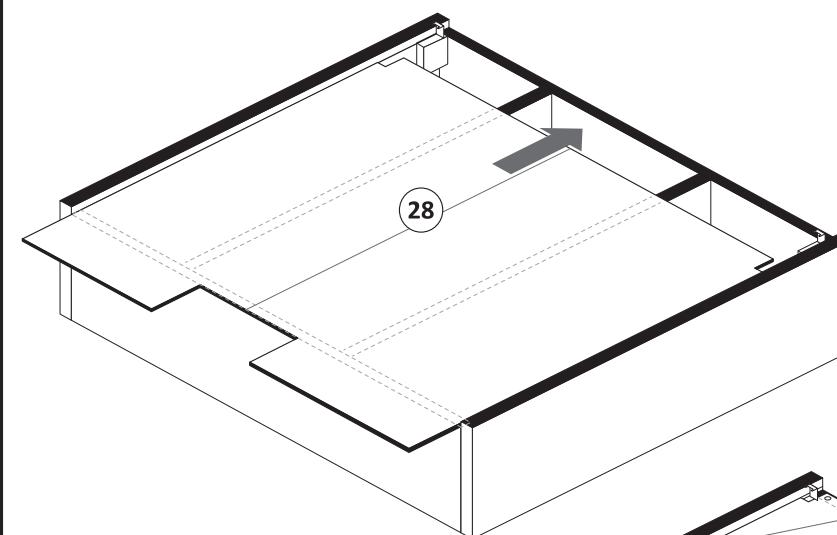

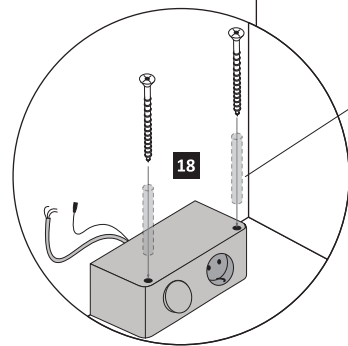
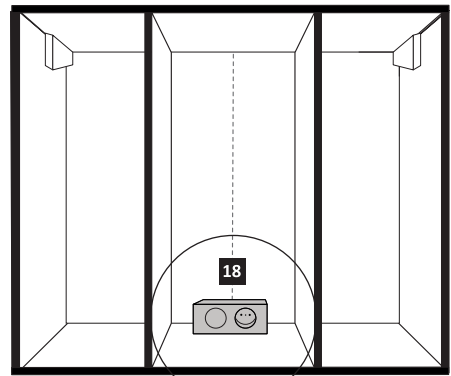
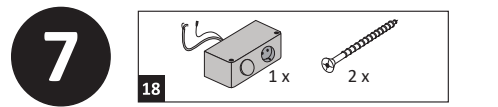

Achtung !!
Die Distanzhülsen sind optional im Lieferumfang.
Nur bei Bedarf nutzen.

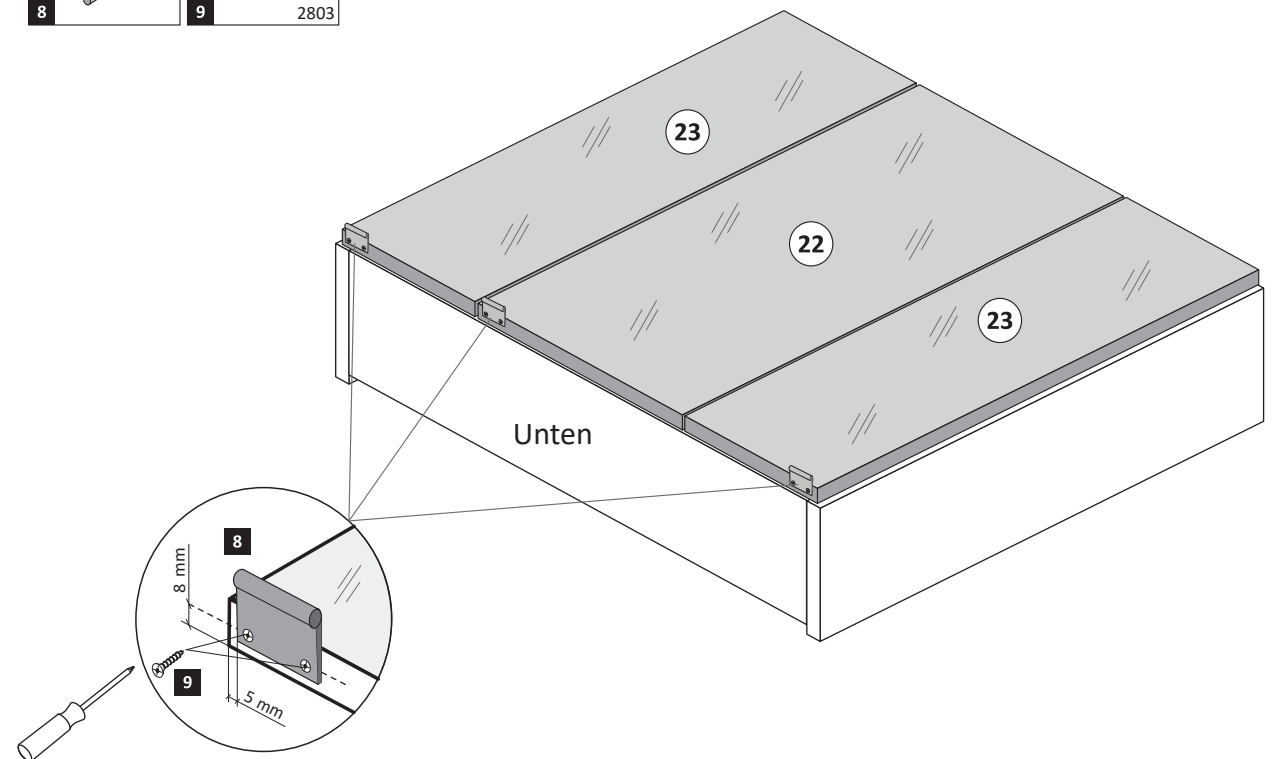
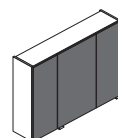
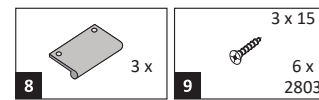
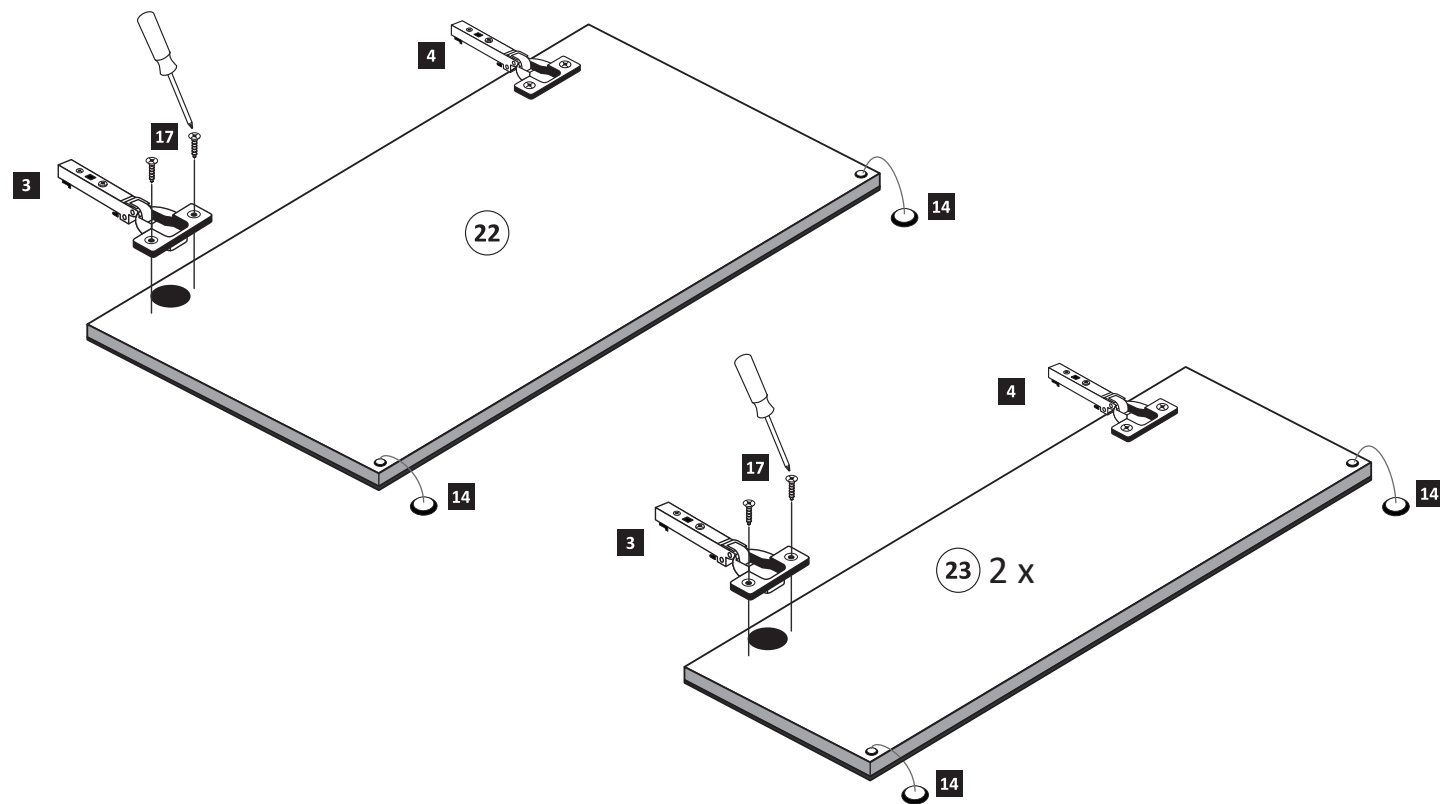
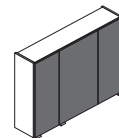
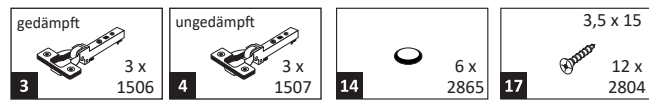
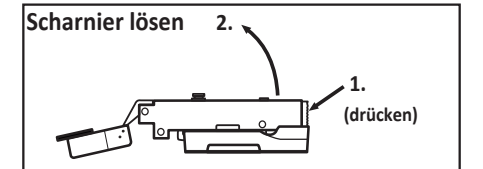
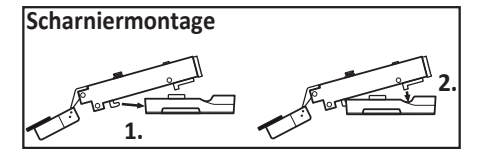
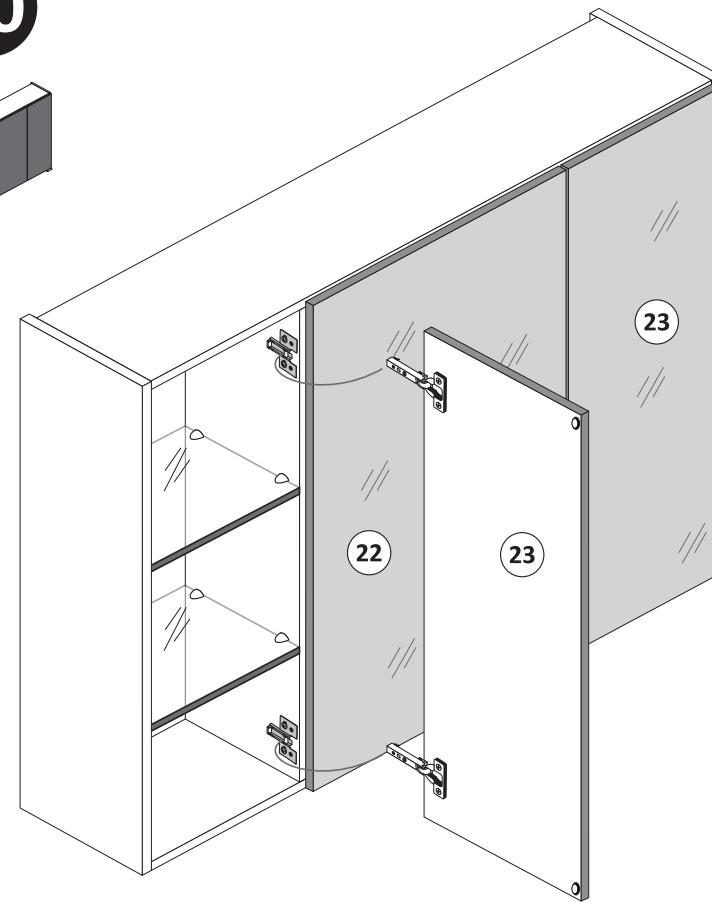
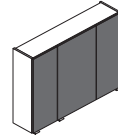
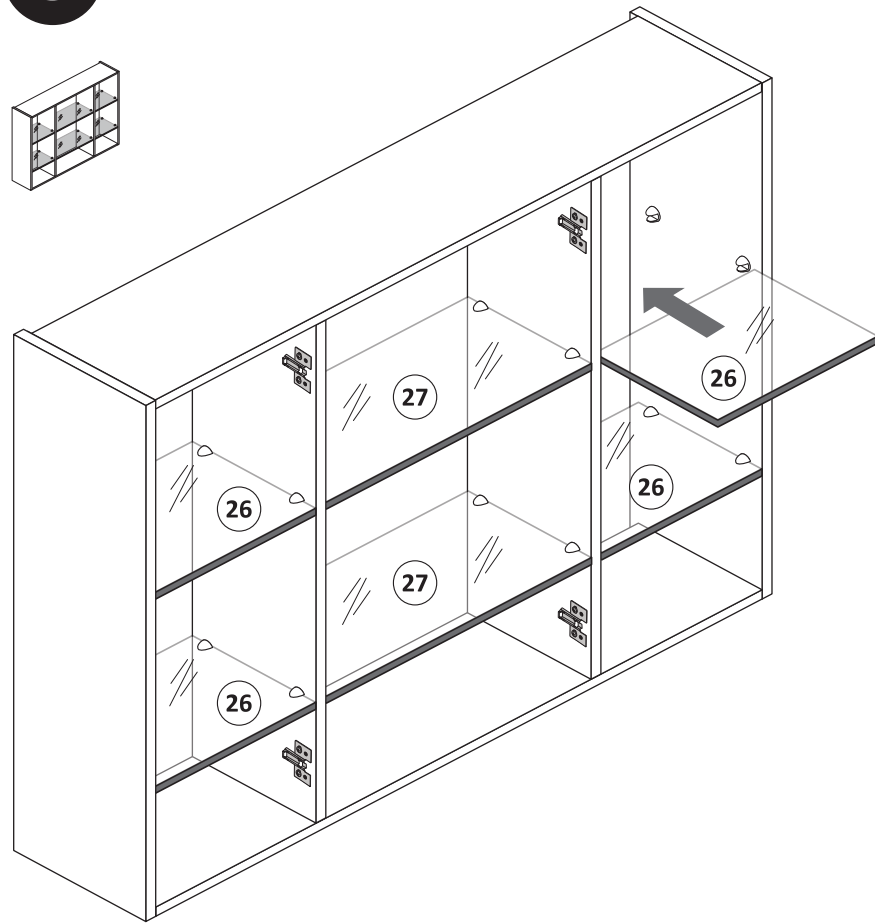
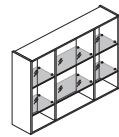

12

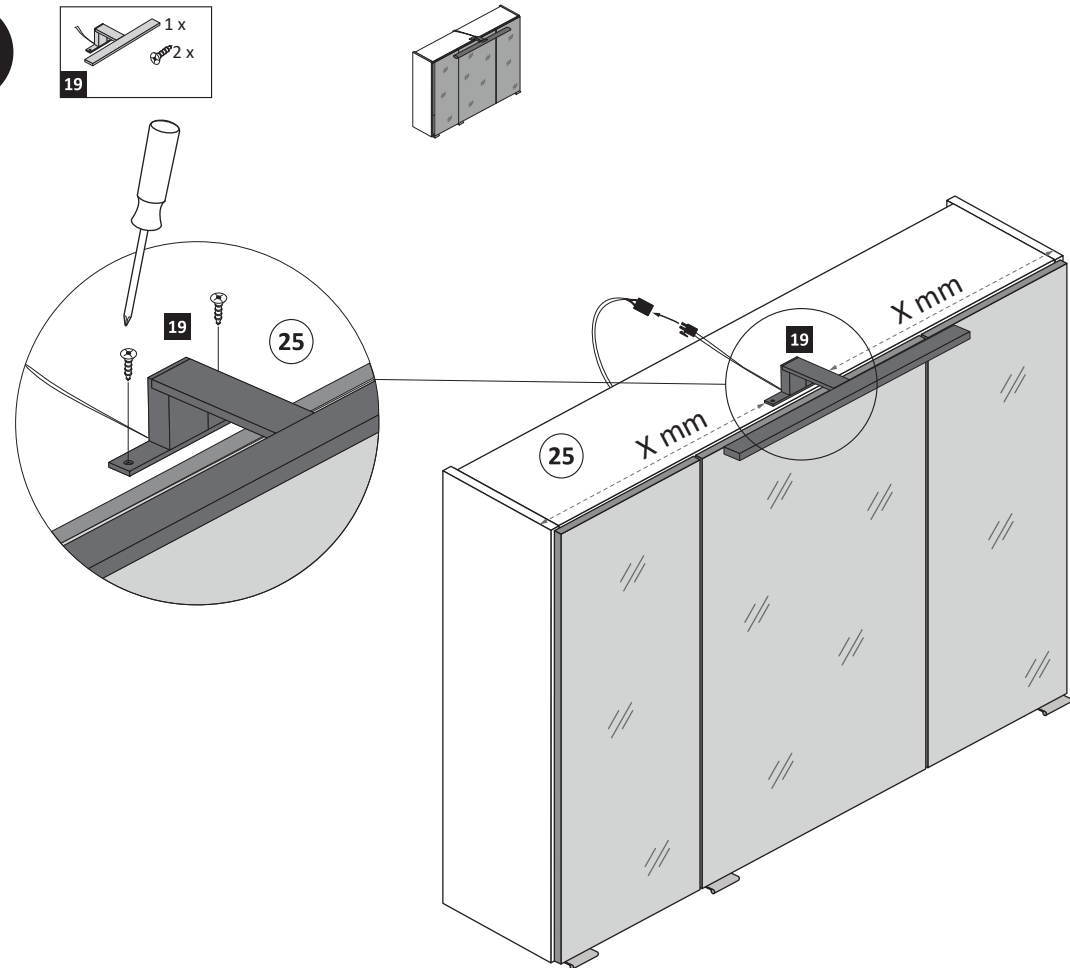

13

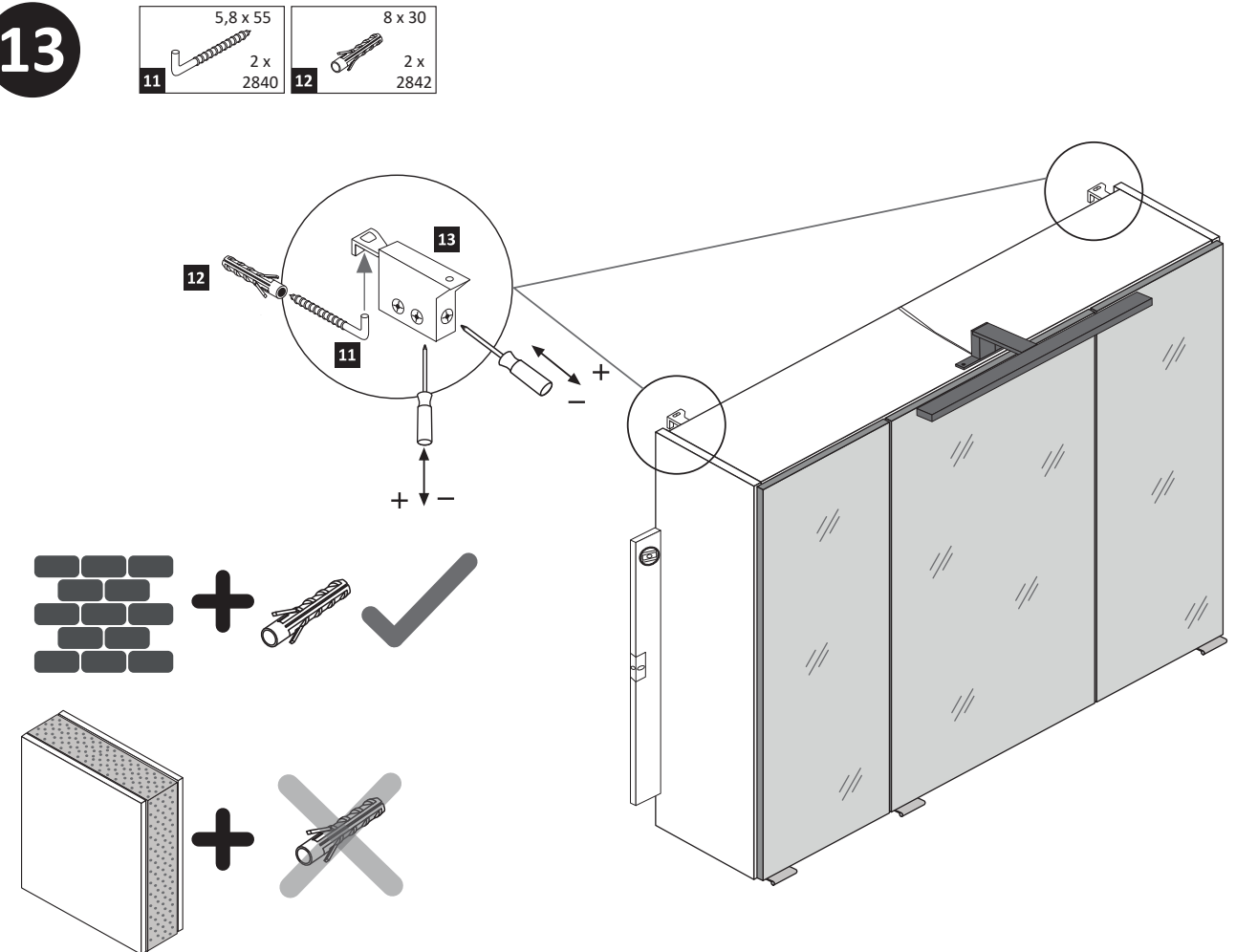

14

3,5 x 15
12 x 2804
17

1. Türen einstellen.

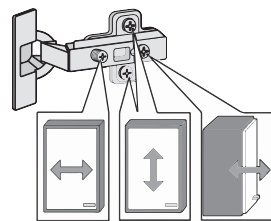

Achtung !!
Aus Sicherheitsgründen ist die Montage der Sicherungsschrauben zwingend notwendig. Nachdem montieren der Sicherungsschrauben ist die Höheneinstellung der Türen nicht mehr möglich!



2. Sicherungsschrauben montieren.

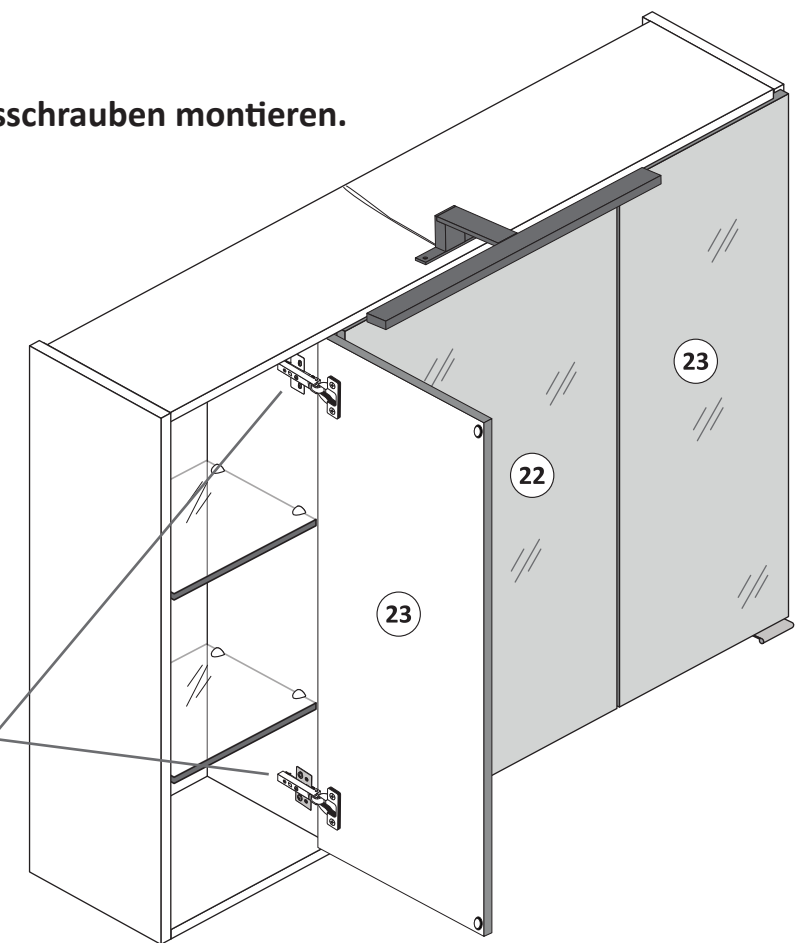
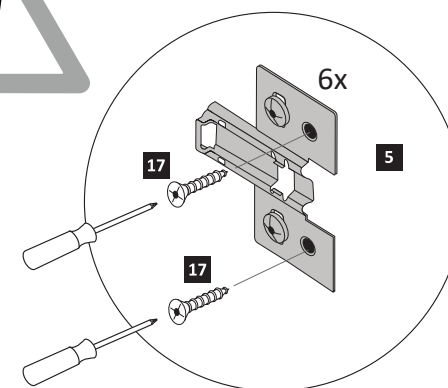
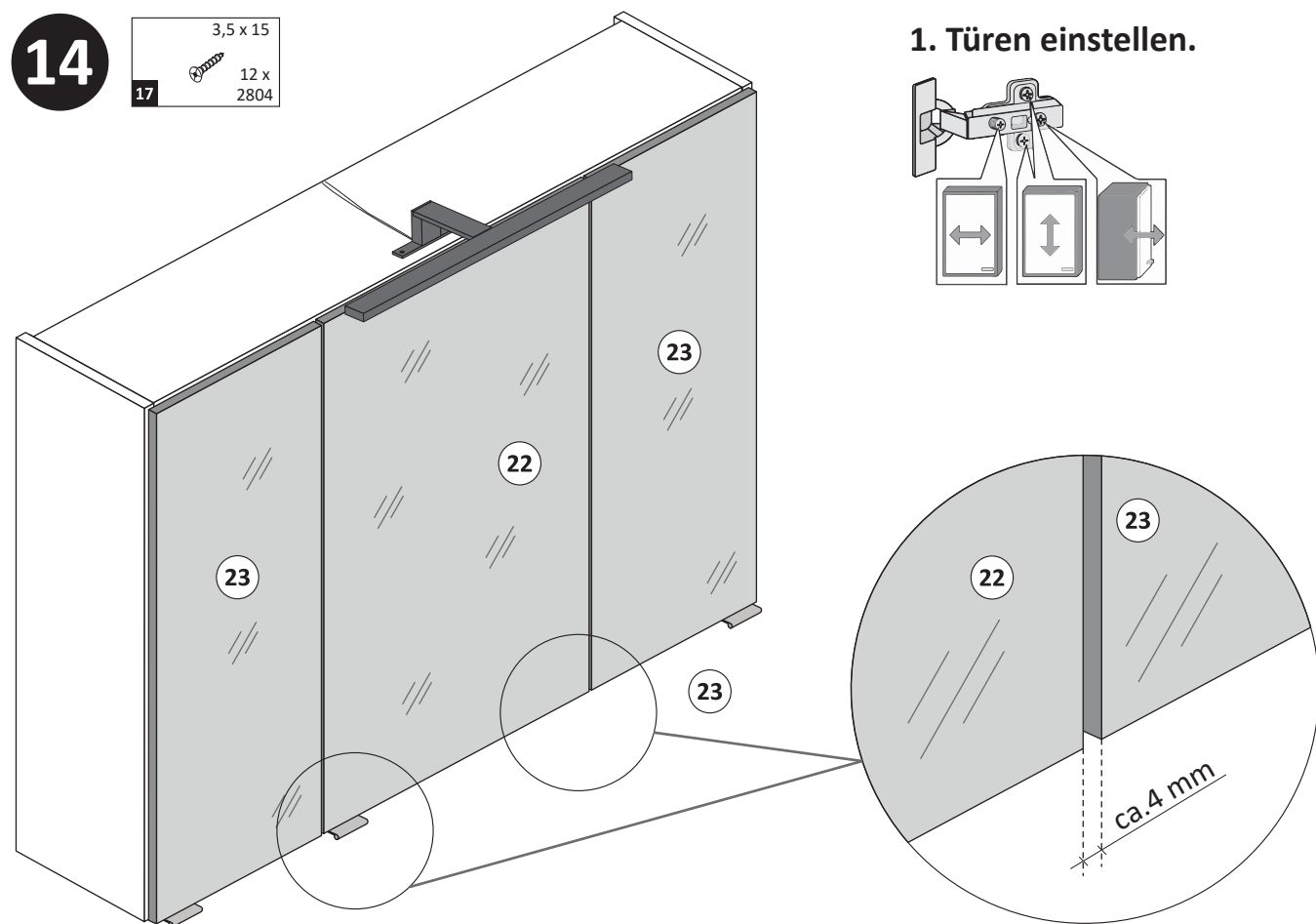



D

Wichtige Sicherheitshinweise

Die Installation Ihrer neuen Leuchte darf ausschließlich von autorisierten Fachpersonen durchgeführt werden.



www.till-hilft.de

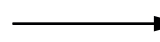

Montagehilfen



PL

Ważne wskazówki dotyczące bezpieczeństwa

Ta instalację nowej lampy mogą przeprowadzać wyłącznie autoryzowani instalatorzy



www.till-hilft.de

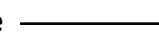

Montagehilfen



GB

Important safety instructions

The installation of your new luminaire may only be carried out by authorized specialists.



www.till-hilft.de

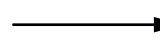

Montagehilfen



SK

Dôležité bezpečnostné upozornenia

Inštaláciu lampy smú vykonať výhradne autorizovani



www.till-hilft.de

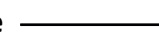

Montagehilfen



FR

signes de sécurité importantes

La L'installation votre nouveau luminaire doit uniquement être réalisée par des spécialistes autorisés



www.till-hilft.de

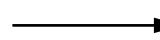

Montagehilfen



HU

Fontos biztonsági utmutatások

Az On Új lámpájának beszerelését kizárólag hivatalos szakember végezheti el



www.till-hilft.de

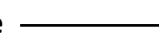

Montagehilfen



IT

Important disposizioni di sicurezza

L'installazione della il loro nuovo lampada può essere eseguita solo ed esclusivamente da personale tecnico autorizzato.



www.till-hilft.de

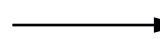

Montagehilfen



RO

Instrucțiuni de siguranță importante

Instalarea noii dumneavoastră lămpi este permisă exclusiv specialișilor autorizați



www.till-hilft.de

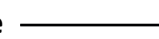

Montagehilfen



NL

Belangrijke veiligheidsaanwijzingen

De installatie van de nieuwe lamp moet worden uitgevoerd door vakbekwame personen worden uitgevoerd.



www.till-hilft.de



Montagehilfen



TR

Önemli güvenlik uyarıları

Yeni lamba montajı yetkin kişiler tarafından yapılmalıdır



www.till-hilft.de



Montagehilfen



CZ

Důležité bezpečnostní pokyny

Instalaci nových svídel smí provádět pouze kvalifikovaný elektrikář



www.till-hilft.de

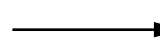

Montagehilfen



RU

важная информация по технике безопасности

Установка вашей новой лампы должна выполняться квалифицированным персоналом



www.till-hilft.de

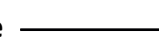

Montagehilfen



89904.330



D

Wichtige Sicherheitshinweise

Die Installation Ihrer neuen Leuchte darf ausschließlich von autorisierten Fachpersonen durchgeführt werden.



www.till-hilft.de

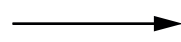

Montagehilfen



PL

Ważne wskazówki dotyczące bezpieczeństwa

Ta instalację nowej lampy mogą przeprowadzać wyłącznie autoryzowani instalatorzy



www.till-hilft.de

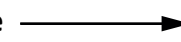

Montagehilfen



GB

Important safety instructions

The installation of your new luminaire may only be carried out by authorized specialists.



www.till-hilft.de

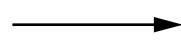

Montagehilfen



SK

Dôležité bezpečnostné upozornenia

Inštaláciu lampy smú vykonať výhradne autorizovaní



www.till-hilft.de

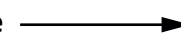

Montagehilfen



FR

signes de sécurité importantes

La L'installation votre nouveau luminaire doit uniquement être réalisée par des spécialistes autorisés



www.till-hilft.de

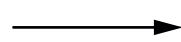

Montagehilfen



HU

Fontos biztonsági utmutatások

Az On Új lámpájának beszerelését kizárólag hivatalos szakember végezheti el



www.till-hilft.de

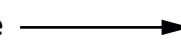

Montagehilfen



IT

Important disposizioni di sicurezza

L'installazione della il loro nuovo lampada può essere eseguita solo ed esclusivamente da personale tecnico autorizzato.



www.till-hilft.de

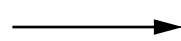

Montagehilfen



RO

Instrucțiuni de siguranță importante

Instalarea noii dumneavoastră lămpi este permisă exclusiv specialișilor autorizați



www.till-hilft.de

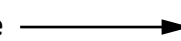

Montagehilfen



NL

Belangrijke veiligheidsaanwijzingen

De installatie van de nieuwe lamp moet worden uitgevoerd door vakkbekwame personen worden uitgevoerd.



www.till-hilft.de

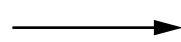

Montagehilfen



TR

Önemli güvenlik uyarıları

Yeni lamba montajı yetkin kişiler tarafından yapılmalıdır



www.till-hilft.de

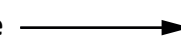

Montagehilfen



CZ

Důležitá bezpečnostní pokyny

Instalaci nových svídel smí provádět pouze kvalifikovaný elektrikář



www.till-hilft.de



Montagehilfen



RU

важная информация по технике безопасности

Установка вашей новой лампы должна выполняться квалифицированным персоналом



www.till-hilft.de



Montagehilfen



89904.330



D

Wichtige Sicherheitshinweise

Die Installation Ihrer neuen Leuchte darf ausschließlich von autorisierten Fachpersonen durchgeführt werden.



www.till-hilft.de

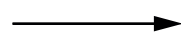

Montagehilfen



PL

Ważne wskazówki dotyczące bezpieczeństwa

Ta instalację nowej lampy mogą przeprowadzać wyłącznie autoryzowani instalatorzy



www.till-hilft.de

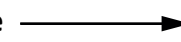

Montagehilfen



GB

Important safety instructions

The installation of your new luminaire may only be carried out by authorized specialists.



www.till-hilft.de

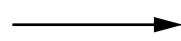

Montagehilfen



SK

Dôležité bezpečnostné upozornenia

Inštaláciu lampy smú vykonať výhradne autorizovaní



www.till-hilft.de

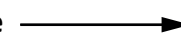

Montagehilfen



FR

signes de sécurité importantes

La L'installation votre nouveau luminaire doit uniquement être réalisée par des spécialistes autorisés



www.till-hilft.de

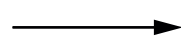

Montagehilfen



HU

Fontos biztonsági utmutatások

Az On Új lámpájának beszerelését kizárólag hivatalos szakember végezheti el



www.till-hilft.de

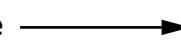

Montagehilfen



IT

Important disposizioni di sicurezza

L'installazione della il loro nuovo lampada può essere eseguita solo ed esclusivamente da personale tecnico autorizzato.



www.till-hilft.de

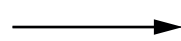

Montagehilfen



RO

Instrucțiuni de siguranță importante

Instalarea noii dumneavoastră lămpi este permisă exclusiv specialișilor autorizați



www.till-hilft.de

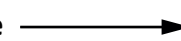

Montagehilfen



NL

Belangrijke veiligheidsaanwijzingen

De installatie van de nieuwe lamp moet worden uitgevoerd door vakbekwame personen worden uitgevoerd.



www.till-hilft.de

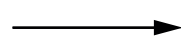

Montagehilfen



TR

Önemli güvenlik uyarıları

Yeni lamba montajı yetkin kişiler tarafından yapılmalıdır



www.till-hilft.de

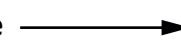

Montagehilfen



CZ

Důležité bezpečnostní pokyny

Instalaci nových svídel smí provádět pouze kvalifikovaný elektrikář



www.till-hilft.de



Montagehilfen



RU

важная информация по технике безопасности

Установка вашей новой лампы должна выполняться квалифицированным персоналом



www.till-hilft.de



Montagehilfen



89904.330

**D****Wichtige Pflegehinweise**

Bitte beachten Sie die wichtigen Pflegehinweise auf unserer Internetseite

www.till-hilft.de

Pflegehinweise

**PL****Ważne instrukcje dotyczące pielęgnacji**

Zwróć uwagę na ważną instrukcję dotyczącą pielęgnacji na naszej stronie internetowej

www.till-hilft.de

Pflegehinweise

**GB****Important care instructions**

Please note the important care instructions on our website

www.till-hilft.de

Pflegehinweise

**SK****Dôležité pokyny na starostlivosť**

Dbajte na dôležité pokyny týkajúce sa starostlivosti na našich webových stránkach

www.till-hilft.de

Pflegehinweise

**FR****Instructions d'entretien importantes**

S'il vous plaît noter les instructions de soins importants sur notre site Web

www.till-hilft.de

Pflegehinweise

**HU****Fontos kezelési utasítások**

Kérjük, vegye figyelembe a honlapunkon található fontos kezelési útmutatót

www.till-hilft.de

Pflegehinweise

**IT****Importanti istruzioni per la cura**

Si prega di notare le importanti istruzioni per la cura sul nostro sito web

www.till-hilft.de

Pflegehinweise

**RO****Instrucțiunile importante de îngrijire**

Rețineți instrucțiunile importante de îngrijire de pe site-ul nostru

www.till-hilft.de

Pflegehinweise

**NL****Belangrijke zorginstructies**

Let op de belangrijke zorginstructies op onze website

www.till-hilft.de

Pflegehinweise

**TR****Önemli bakım talimatları**

Lütfen web sitemizdeki önemli bakım talimatlarını dikkate alınız

www.till-hilft.de

Pflegehinweise

**CZ****Důležité pokyny pro péči**

Vezměte prosím na vědomí důležité pokyny pro péči na našich webových stránkách

www.till-hilft.de

Pflegehinweise

**RU****Важные инструкции по уходу**

Обратите внимание на важные инструкции по уходу на нашем веб-сайте

www.till-hilft.de

Pflegehinweise



**D****Wichtige Pflegehinweise**

Bitte beachten Sie die wichtigen Pflegehinweise auf unserer Internetseite

www.till-hilft.de

Pflegehinweise

**PL****Ważne instrukcje dotyczące pielęgnacji**

Zwróć uwagę na ważną instrukcję dotyczącą pielęgnacji na naszej stronie internetowej

www.till-hilft.de

Pflegehinweise

**GB****Important care instructions**

Please note the important care instructions on our website

www.till-hilft.de

Pflegehinweise

**SK****Dôležité pokyny na starostlivosť**

Dbajte na dôležité pokyny týkajúce sa starostlivosti na našich webových stránkach

www.till-hilft.de

Pflegehinweise

**FR****Instructions d'entretien importantes**

S'il vous plaît noter les instructions de soins importants sur notre site Web

www.till-hilft.de

Pflegehinweise

**HU****Fontos kezelési utasítások**

Kérjük, vegye figyelembe a honlapunkon található fontos kezelési útmutatót

www.till-hilft.de

Pflegehinweise

**IT****Importanti istruzioni per la cura**

Si prega di notare le importanti istruzioni per la cura sul nostro sito web

www.till-hilft.de

Pflegehinweise

**RO****Instrucțiunile importante de îngrijire**

Rețineți instrucțiunile importante de îngrijire de pe site-ul nostru

www.till-hilft.de

Pflegehinweise

**NL****Belangrijke zorginstructies**

Let op de belangrijke zorginstructies op onze website

www.till-hilft.de

Pflegehinweise

**TR****Önemli bakım talimatları**

Lütfen web sitemizdeki önemli bakım talimatlarını dikkate alınız

www.till-hilft.de

Pflegehinweise

**CZ****Důležité pokyny pro péči**

Vezměte prosím na vědomí důležité pokyny pro péči na našich webových stránkách

www.till-hilft.de

Pflegehinweise

**RU****Важные инструкции по уходу**

Обратите внимание на важные инструкции по уходу на нашем веб-сайте

www.till-hilft.de

Pflegehinweise

