

Artikelnummer:
70966

EAN-Nummer:
4000870709665



Name
Function MaxLED Flow Basisset 3m RGB Funk Control 2.4GHz _W 230/24V _VA weiß

Hersteller
Paulmann

Kaufmännische Daten

Garantie	5 Jahre
SB Artikel	SB-Verpackung

Technische Daten

Anzahl Brennstellen	nv
aufgenommene Leistung	30 W
Batterietyp	1xCR 2025/3V
Bestückung	incl. 1x27 W
Dimmbar	Ja
Farbe	Weiß
Gewicht brutto	906 g
Gewicht netto	797 g
Lebensdauer	20.000 h
Inklusive Leuchtmittel	✓
Material	Kunststoff
Scheinleistung	30 VA
Spannung	230/24 V
Trafoleistung	36 VA



Leuchtmitteldaten

Nennlichtstrom	810 lm
Lichtstrom LED-Modul	1200 lm
Lichtstrom LED-Modul 360°	1200 lm
Scheinleistung	30 VA
Entspricht Glühlampe	83 W
Zündzeit <	0,0 s

Abmessungen

Abmessung (Höhe x Breite x Tiefe)	10 x x 10 mm
Länge	3 m
Höhe	10 mm
Tiefe	10 mm

Texte

Katalogname	MaxLED Flow RGB Basic Set 3m
-------------	------------------------------

Kaufmännische Daten II

Zolltarifnummer	94054039900
Ursprungsland	CN
Verpackungseinheit SAP	1
Verpackungsmaße BxHxL	20 x 22 x 8.3 cm

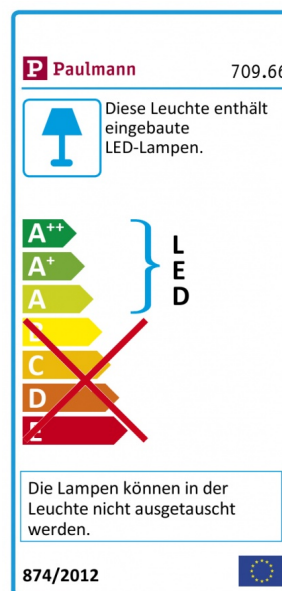

Safety Instructions

1, 2, 3, 4, 7, 9, 11, 12, 13, 14, 16, 17, 18, 19, 21, 33, 34



Info

www.paulmann.com

Paulmann Licht GmbH
Quezinger Feld 2
31832 Springe
Germany

www.paulmann.com

Art.-Nr. : 709.66
709.67

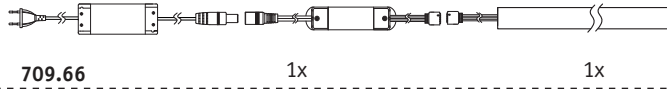

709.66

1x

1x

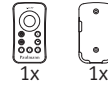

1x

1x



1x



1x



11x



13x



13x



(+326)PPN 01/19

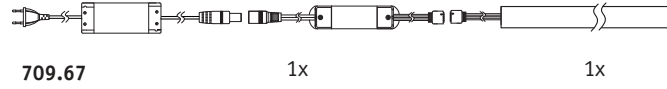

709.67

1x

1x

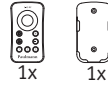

1x

1x



1x



1x



21x



23x



23x

A1 A2



Safety Instructions
Nr. 7, 10

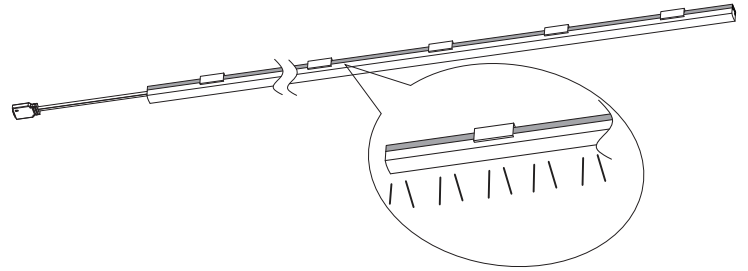
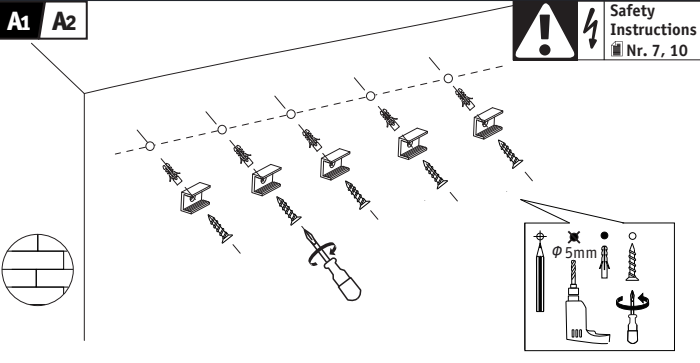

A1 A2



Safety Instructions
Nr. 7, 10

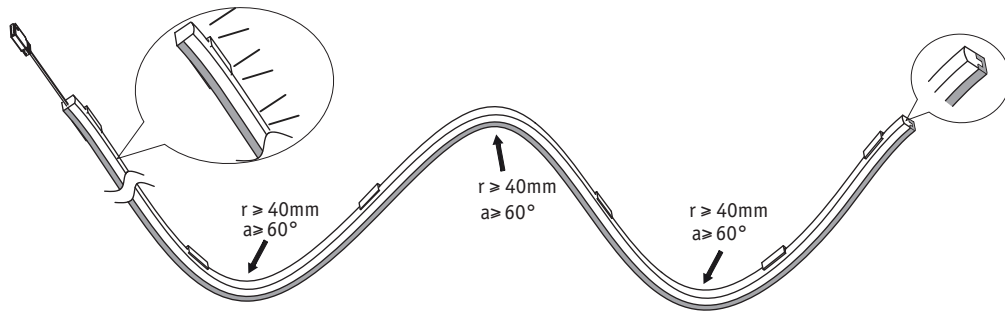
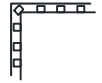
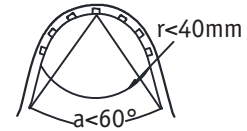
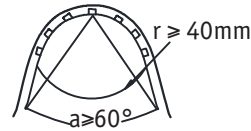
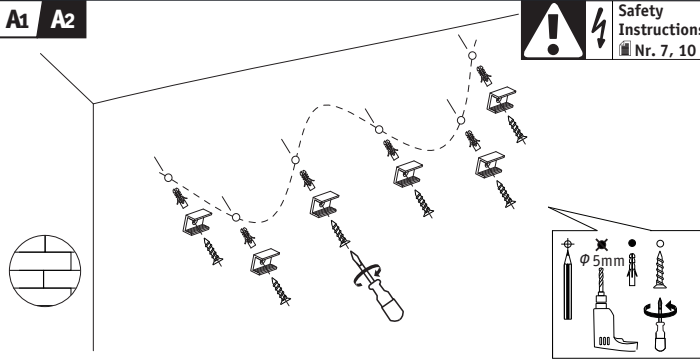

B

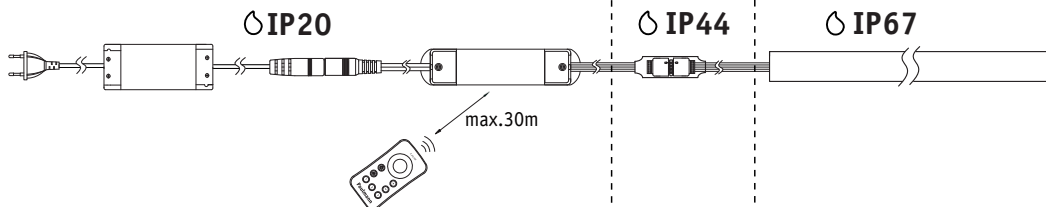
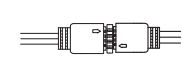
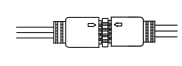
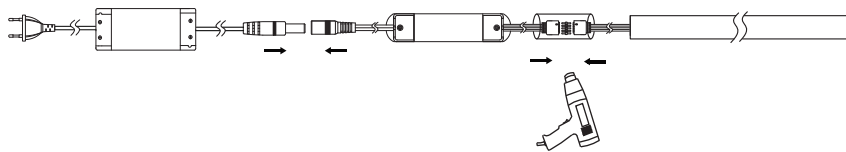

IP20

IP44

IP67

max. 30m

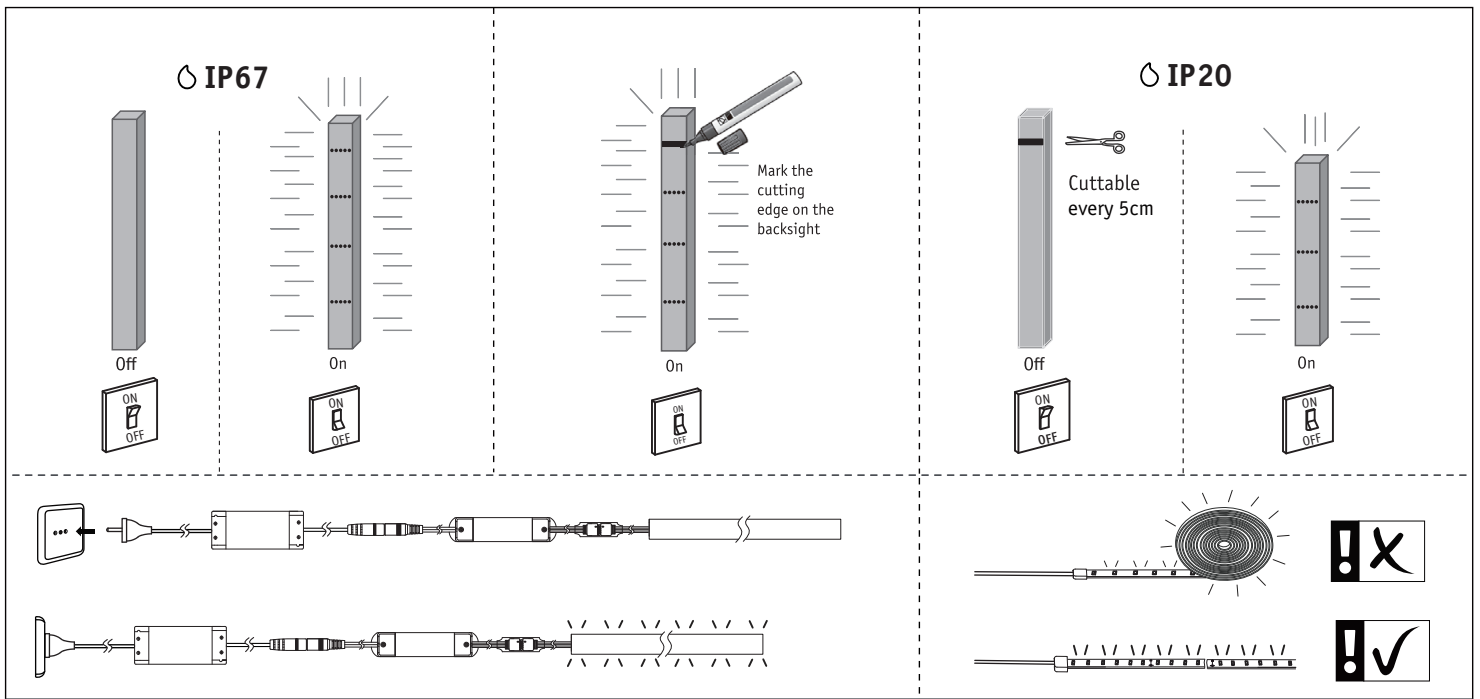

Function of keys

2.4G RF

Color ring

ON/OFF

Mode

Channel

Brightness/Speed +

Brightness/Speed -

Paulmann

Mode

Number	Mode	Adjustable state
1	Red Static	Brightness is adjustable, speed is not adjustable
2	Green Static	
3	Blue Static	
4	Yellow Static	
5	Purple Static	
6	Cyan Static	
7	White Static	
8	3-Colors Jumps	Brightness is not adjustable, speed is adjustable
9	7-Colors Jumps	
10	3-Colors Breath	
11	7-Colors Breath	
12	3-Colors Gradient	
13	Full Colors Gradient	
14	3-Colors Strobe	
15	7-Colors Strobe	
16	Red&Green Gradient	
17	Red&Blue Gradient	
18	Green&Blue Gradient	

Code Matching

(Press the Channel key more than 2S within 5S of connecting to the power supply)

Channel 1

Channel 2

Channel 3

Channel 1

Channel 2

Channel 3

Code Clearing

(Press the Channel key more than 2S within 5S of connecting to the power supply)

Channel 1

Channel 2

Channel 3

Zugelassen für den Betrieb in allen Ländern der EU / Approved for operating in all European countries

CE: Konform mit / in accordance with /conformement a 2014/30/EU, 2014/53/EU <http://www.paulmann.com/de/de/b2b-haendler-log-in.html>

2,4 GHz - 2,4835 GHz

NO

doesn't apply for the geographical area within a radius of 20km from the centre on "Ny Alesund"

Hiermit erklärt Paulmann Licht, dass der Funkanlagentyp Art.-Nr.: 709.66/709.67 der Richtlinie 2014/53/EU entspricht. Der vollständige Text der EU-Konformitätserklärung ist unter der folgenden Internetadresse verfügbar: www.paulmann.com/ce

Funk-Frequenz :2.4GHz-2.4835GHz Abgestrahlte Energie :10mW