

MONTAGEANLEITUNG

Artikelnummer: WF310477AAA

Doppelbett 200x140cm

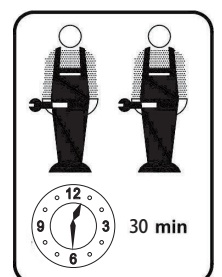
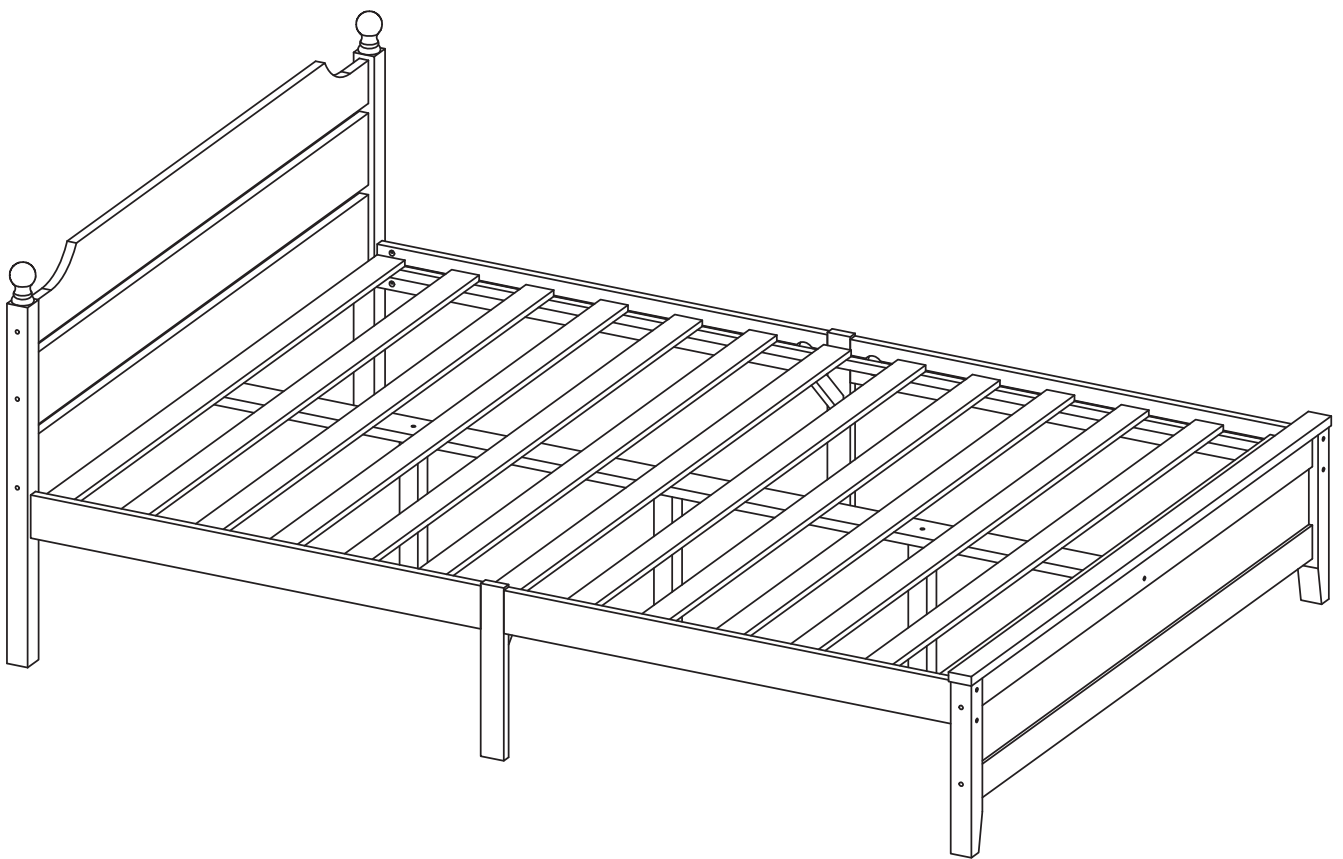

ANLEITUNGEN

WICHTIG - SORGFÄLTIG LESEN - FÜR SPÄTERE VERWENDUNG

AUFBEWAHREN

- a) WARNUNG - Kinder können zwischen dem Bett und der Wand, den angrenzenden Möbelstücken (z. B. Schränken) und der Lücke eingeklemmt werden. Um die Gefahr schwerer Verletzungen zu vermeiden, darf der Abstand zwischen der Sicherheitsbarriere und der angrenzenden Struktur nicht mehr als 75 mm oder mehr als 230 mm betragen.
- b) WARNUNG- Das Bett darf nicht benutzt werden, wenn ein Bauteil gebrochen ist oder fehlt; Ersatzteile sind beim Hersteller oder im Geschäft anzufordern.
- c) WARNUNG - Klettern oder wackeln Sie nicht auf nicht dafür vorgesehenen Strukturen.
- d) Befolgen Sie unbedingt die Installationsanweisungen und die Gebrauchsanweisungen des Herstellers.
- e) Die empfohlene Größe der Matratze für das Bett beträgt **140x200cm**, maximale Dicke der Matratze: **13cm**.
- f) Es ist notwendig, den Raum zu lüften, um die Feuchtigkeit niedrig zu halten und Schimmelbildung im Bett und seiner Umgebung zu verhindern.
- g) Die Verbindungselemente sollten immer richtig angezogen sein und regelmäßig überprüft werden. Ziehen Sie sie gegebenenfalls nach.

INSTRUCTIONS





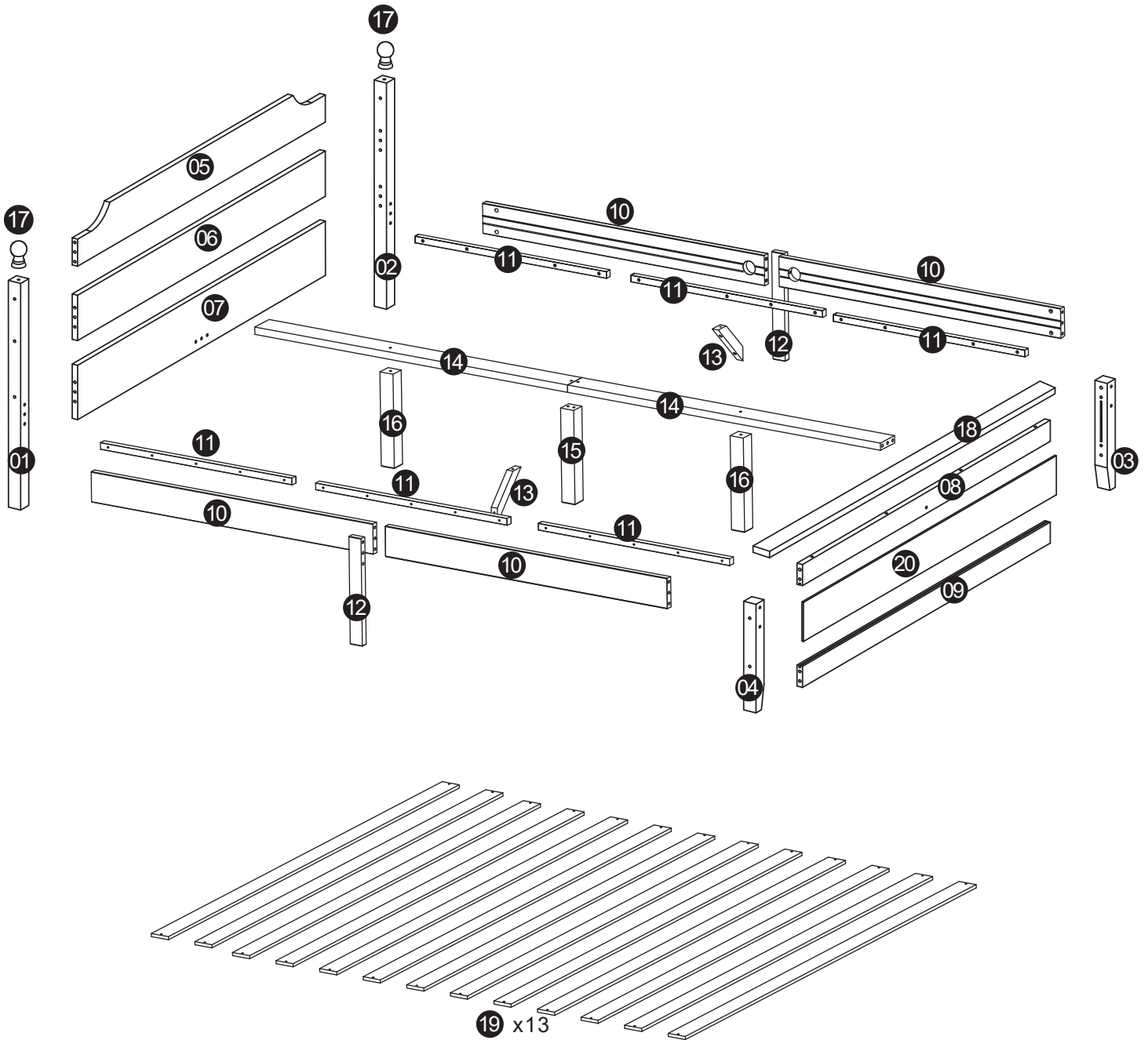

IMPORTANT-READ CAREFULLY-RETAIN FOR FUTURE REFERENCE

- a) WARNING -Children can become trapped between the bed and the wall, the adjoining pieces of furniture (e.g. cupboards) and the like. To avoid risk of serious injury the distance between the safety barrier and the adjoining structure shall not exceed 75 mm or shall be more than 230 mm.
- b) WARNING-Do not use the bed if any structural part is broken or missing; Replacement parts are between requested from the manufacturer or the store.
- c) WARNING-Do not climb or wiggle on any non-designated structures.
- d) it is imperative to always follow the installation instructions and manufacturer's use.
- e) The recommended size of the mattress to be used with the bed is **140x200cm** ,maximum thickness mattress:**13cm**.
- f) It is necessary to ventilate the room in order to maintain a low level moisture and prevent mold growth in the bed and its periphery.
- g) Joining devices should always be tightened properly and regularly verified. Tighten if necessary.

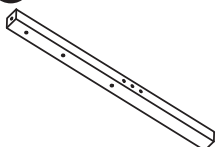
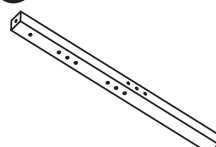
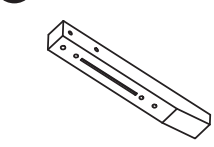
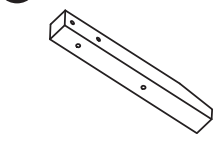
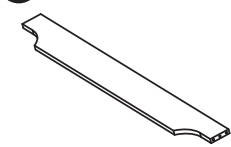
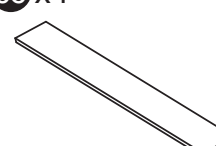
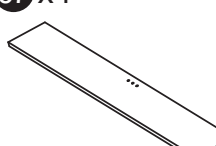
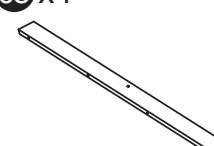
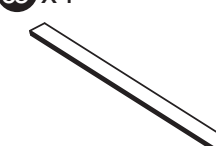

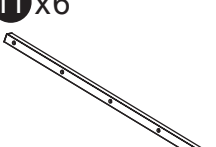
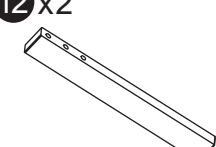
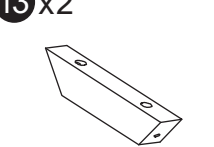

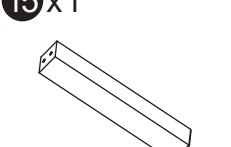
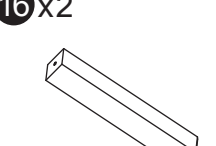

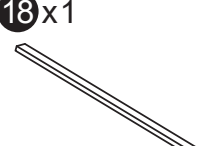
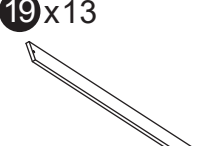
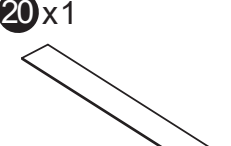



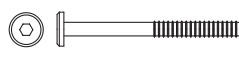

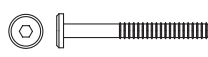
Stückliste

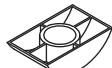

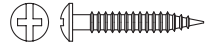
WF310477AAA

01 x1 	02 x1 	03 x1 	04 x1 	05 x1 
06 x1 	07 x1 	08 x1 	09 x1 	10 x4 
11 x6 	12 x2 	13 x2 	14 x2 	15 x1 
16 x2 	17 x2 	18 x1 	19 x13 	20 x1 

WF310477AAA

A x32  Φ8x30	B x18  M6x90	C x20 	D x2  M6x60	E x2 
F x4 	G x4 	H x4 	J x2 	K x34  Φ4x30
L x39  Φ3.5x25	M x1 	N x4  Φ7x50	O x4  Φ6x44	P x4  Φ15x10

Wichtiger Hinweis:

Bestätigen Sie bitte alle Komponenten und Schrauben vor der Montage. Bitte wenden Sie sich an uns, falls einige Teile oder Schrauben im Paket fehlt sind.

Schritt 1

A

 Ø8x30

32

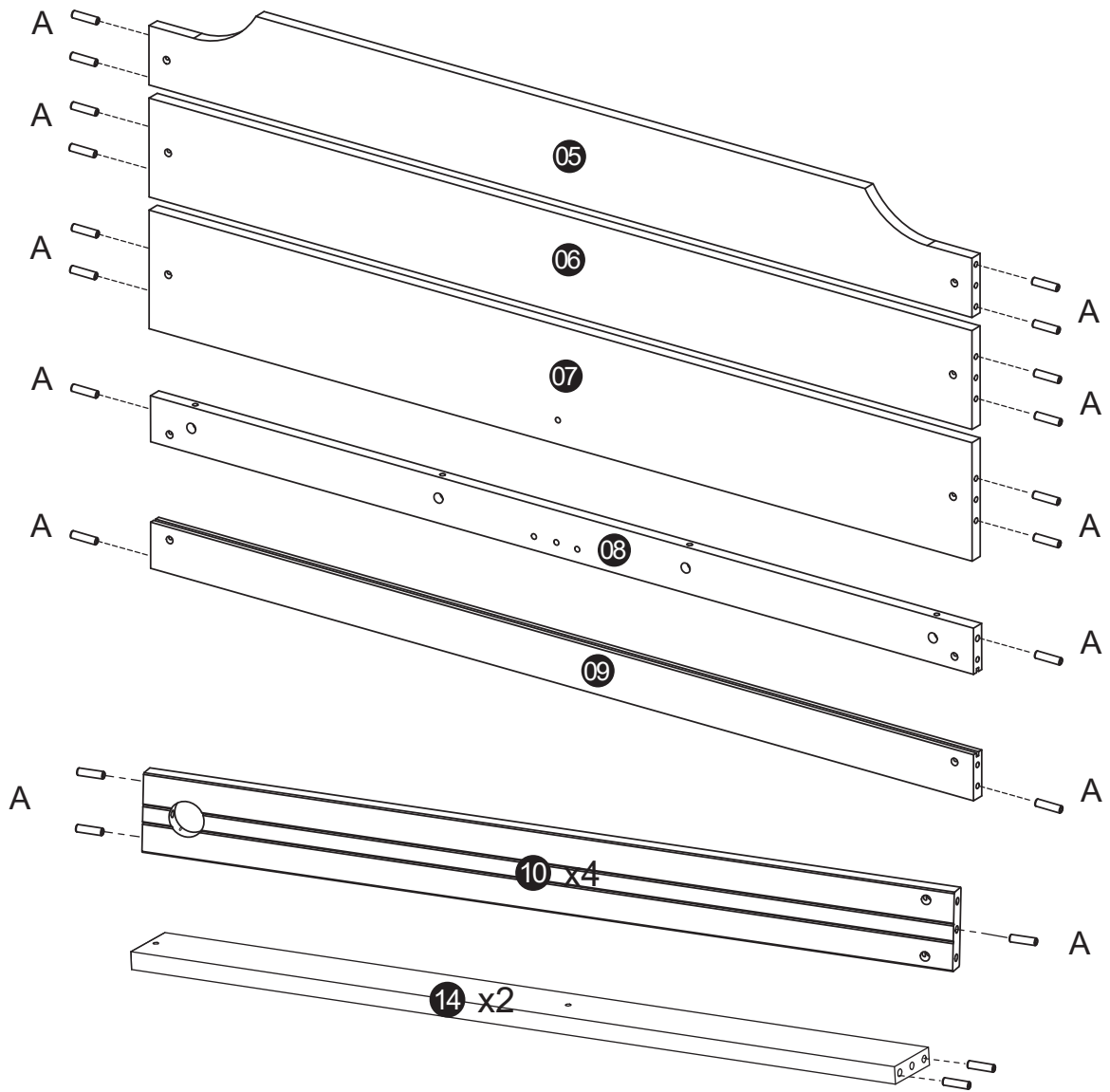

Schritt 3

B

 M6x90

2



C

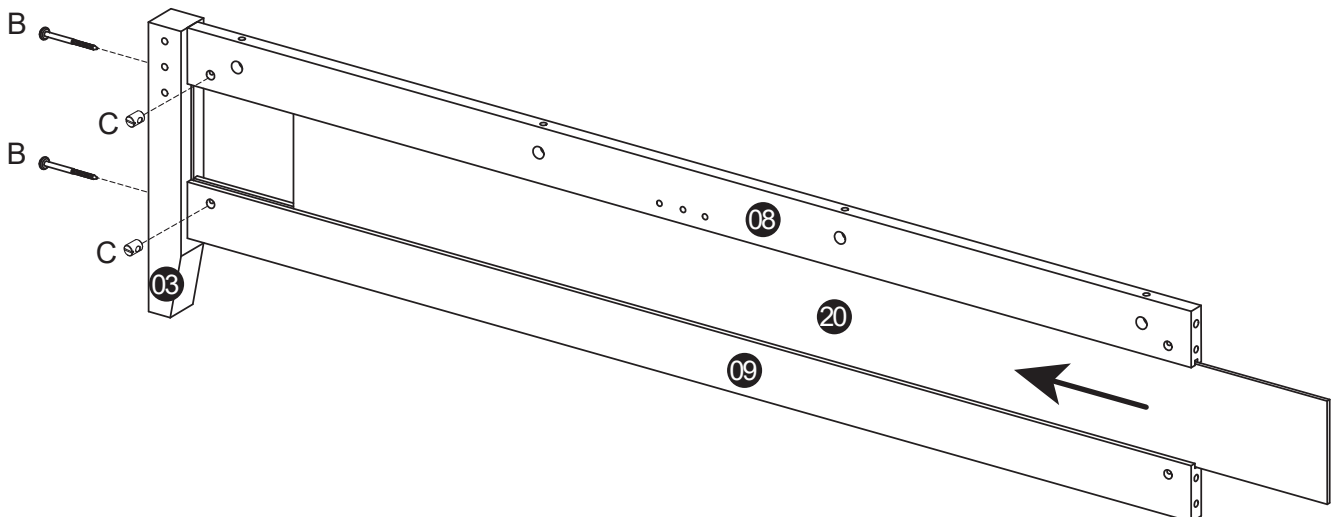

2

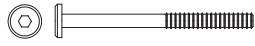

Schritt 2

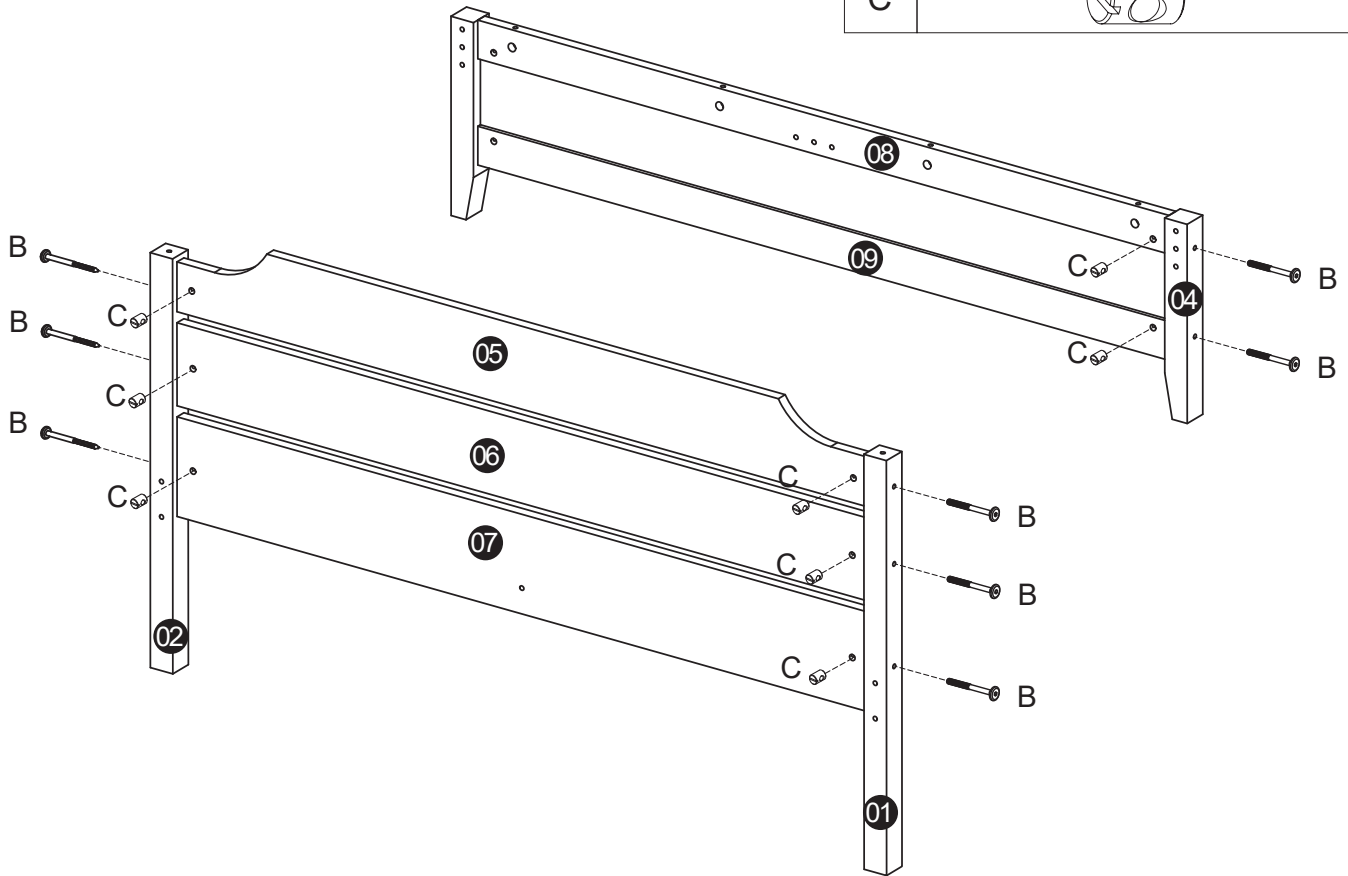

B		M6x90	8
C			8

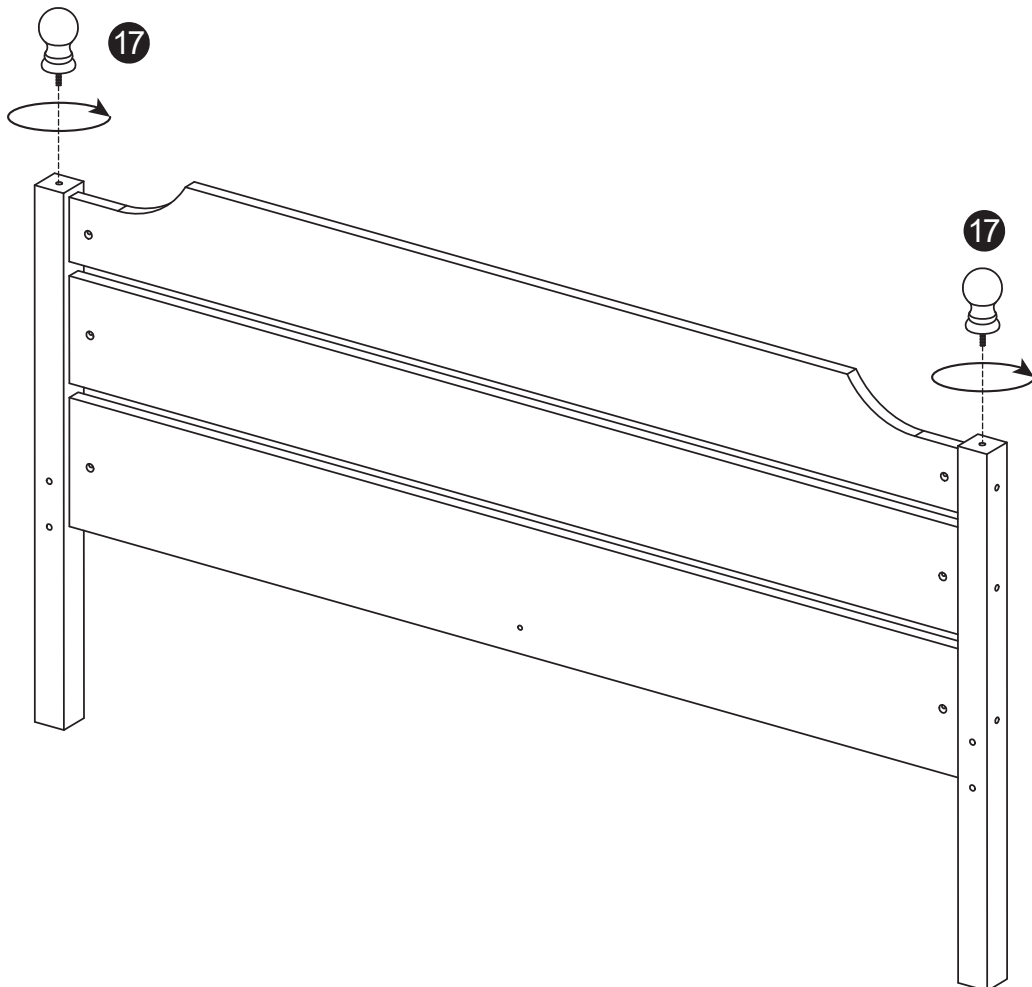

Schritt 3



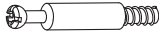

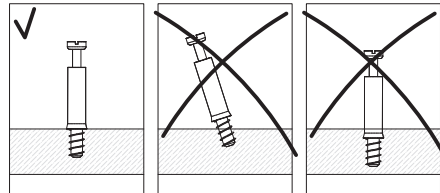
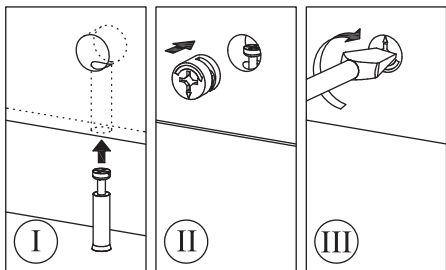
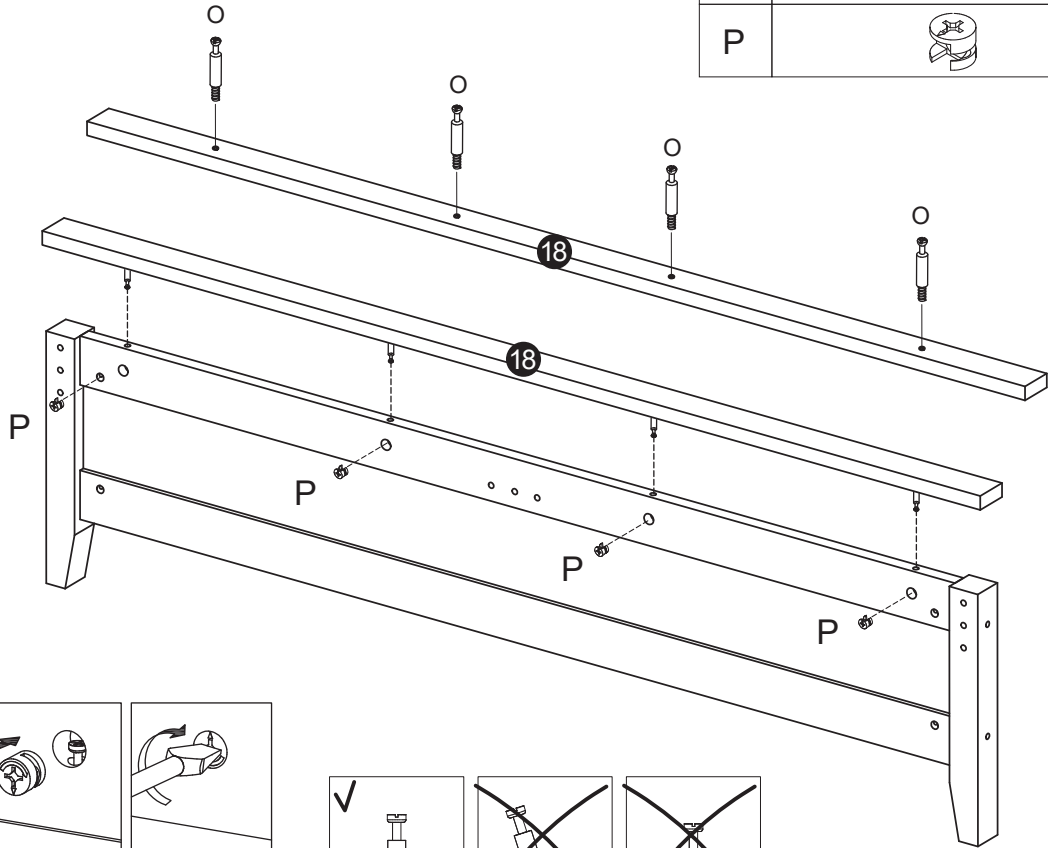

Schritt 4

O		Ø6x44	4
P		Ø15x10	4



Schritt 5

E		2
F		4
G		4
H		4
J		2

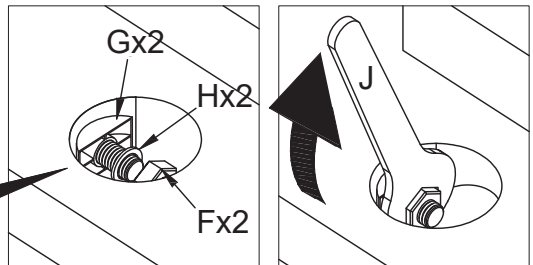
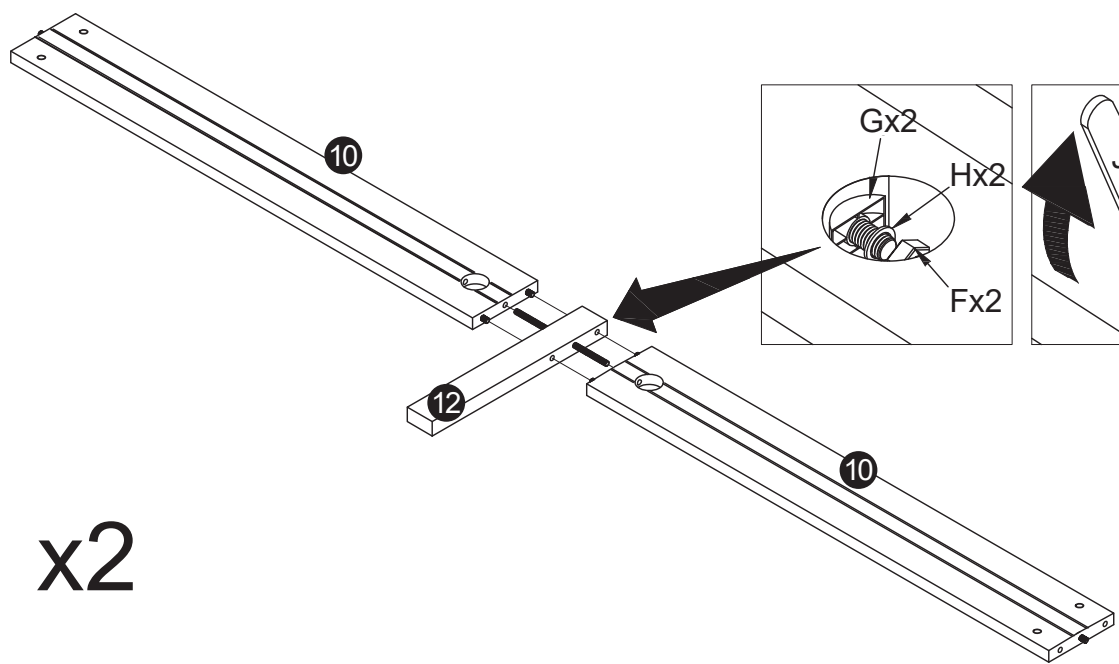
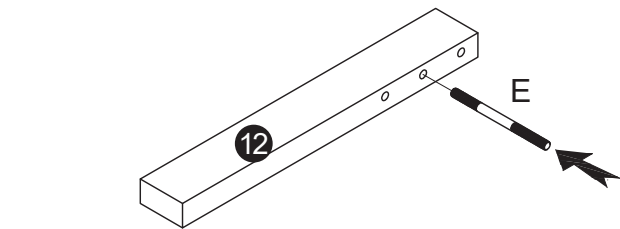

x2

Schritt 6

K



30

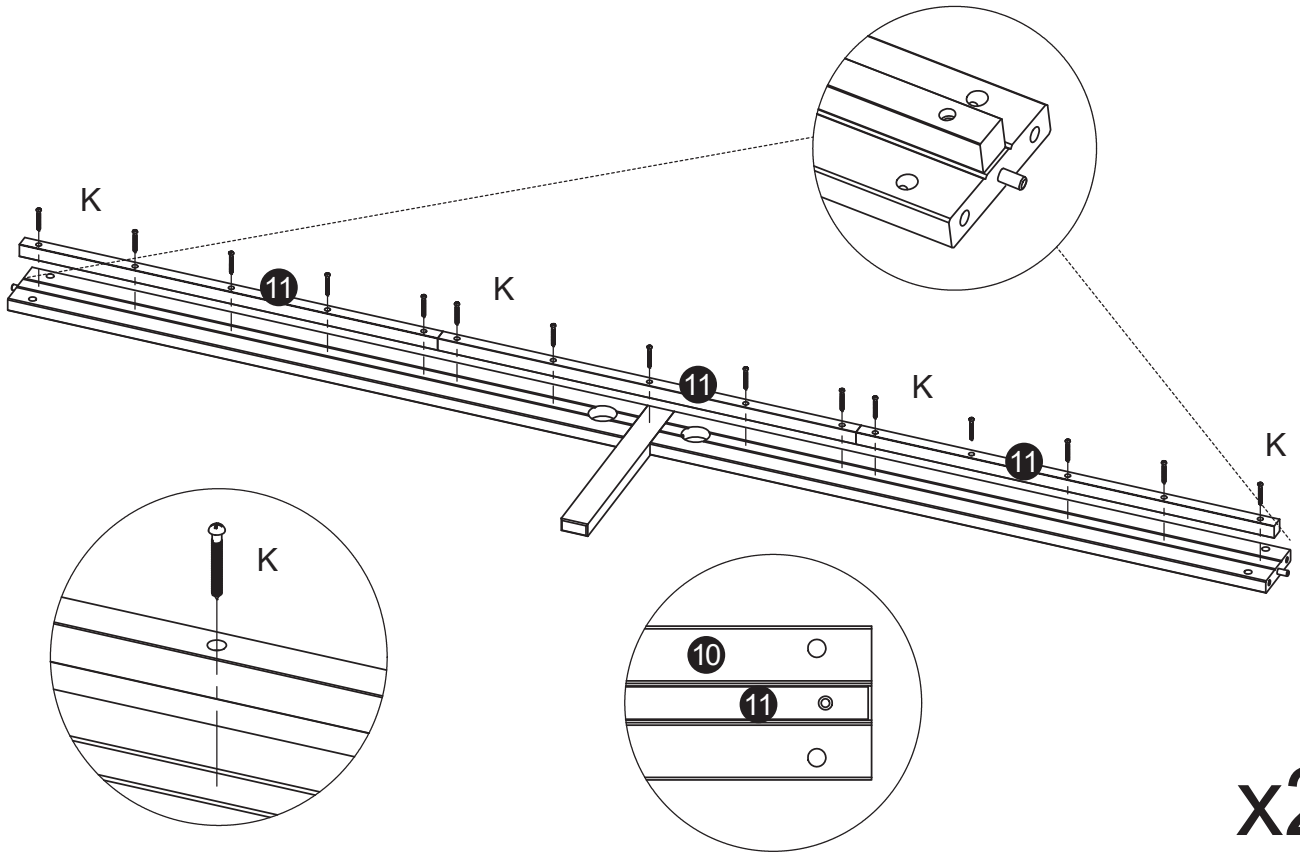

Schritt 7



N

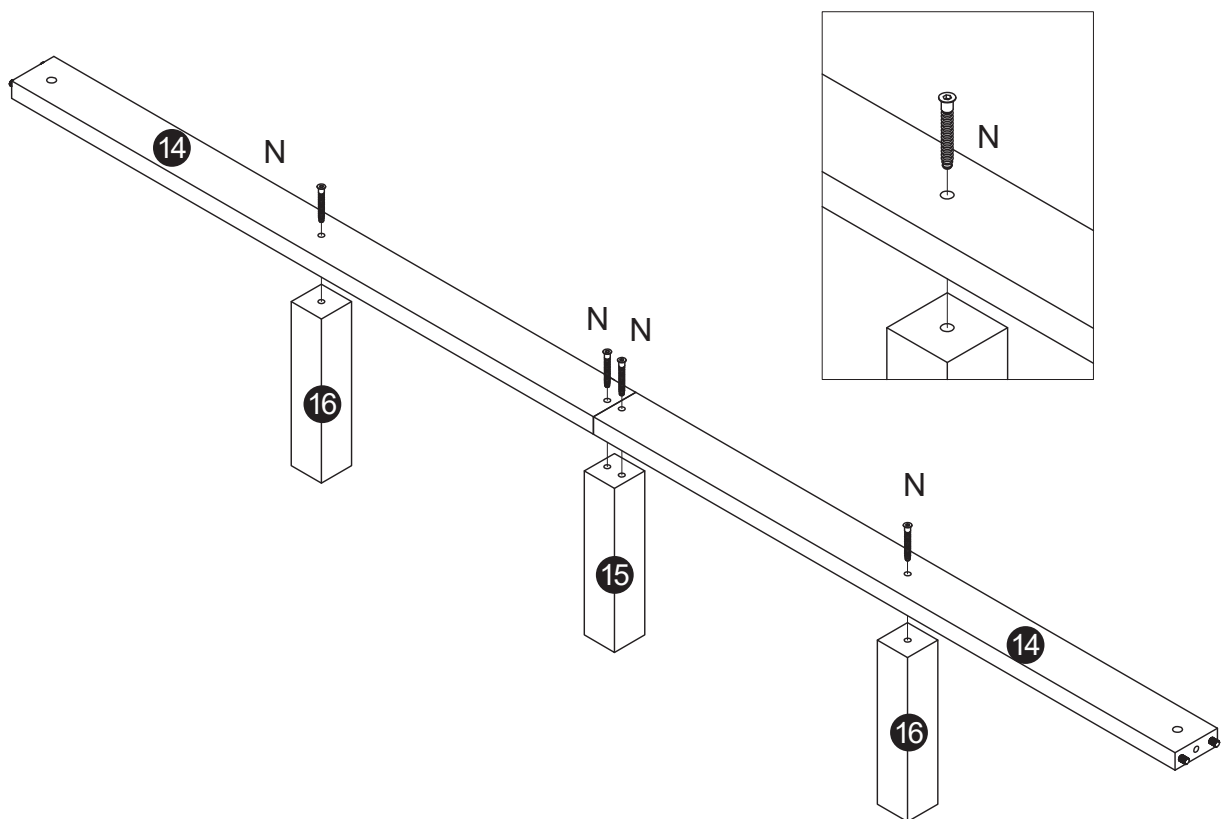

4



Schritt 8

B		M6x90	8
C			10
D		M6x60	2

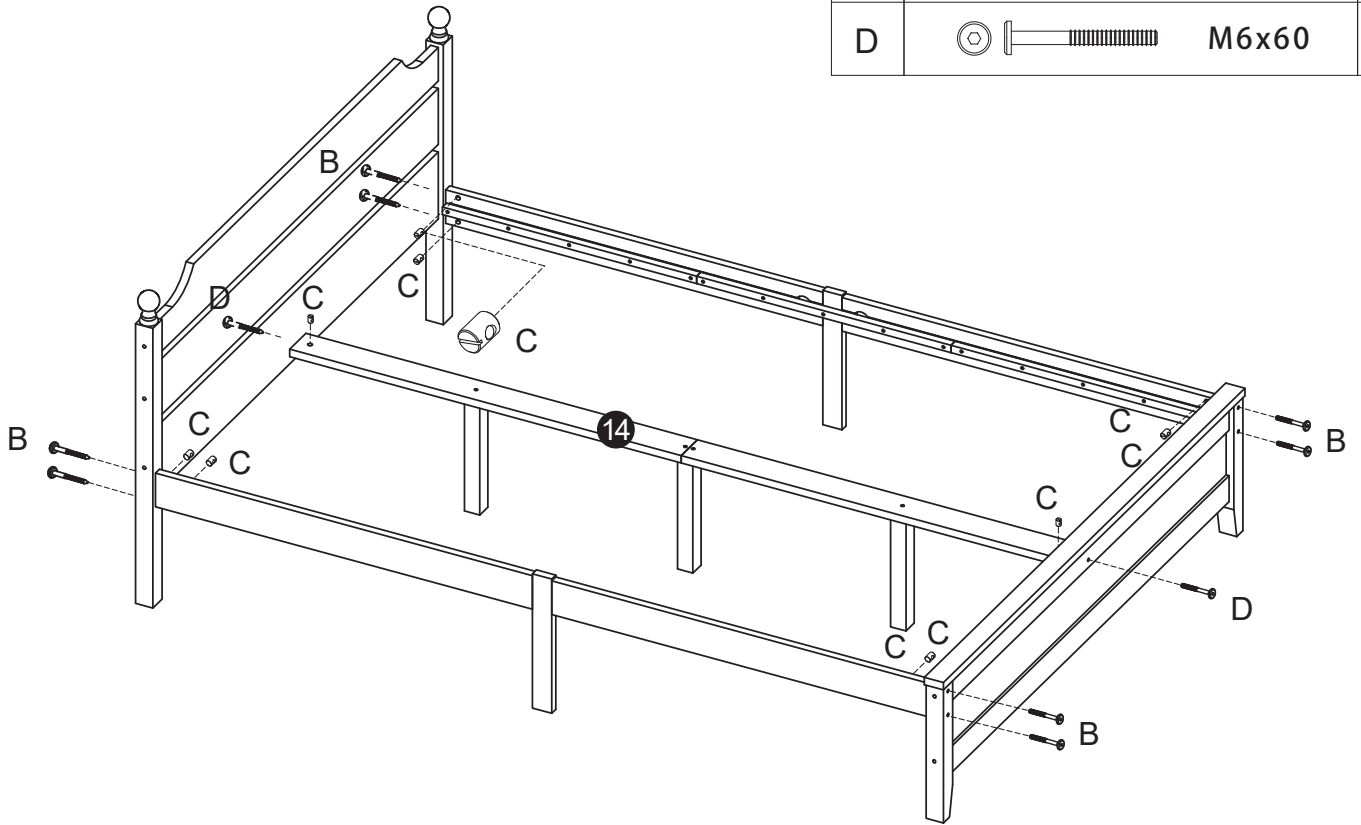

Schritt 9

L		Φ3.5x25	39
---	---	---------	----

