

PERCY V
2501-0037/8300
8100/2503-0037

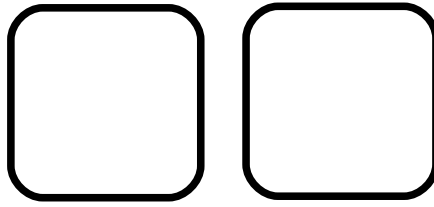

201117

- | | | | |
|-----------|--|-----------|---|
| D | MONTAGEANLEITUNG
BEDIENUNGSANLEITUNG | GB | ASSEMBLY INSTRUCTIONS
INSTRUCTION MANUAL |
| NL | HANDLEIDING VOOR DE MONTAGE
GEBRUIKSAANWIJZING | PL | INSTRUKCJA MONTAŻU
INSTRUKCJA OBSŁUGI |
| TR | MONTAJ TALIMATI
KULLANIM KLAVUZU | RU | ИНСТРУКЦИЯ ПО МОНТАЖУ
ИНСТРУКЦИЯ ПО ЭКСПЛУАТАЦИИ |
| RO | INSTRUCȚIUNI DE INSTALARE
INSTRUCȚIUNI DE UTILIZARE | IT | ISTRUZIONI DI MONTAGGIO
MANUALE DI ISTRUZIONI |
| FR | NOTICE DE MONTAGE
MANUEL INSTRUCTIONS | SK | MONTÁŽNY NÁVOD
NÁVOD NA POUŽITIE |
| HU | KÖZGYŰLÉS UTASÍTÁSOK
KEZELÉSI UTASÍTÁS | CZ | MONTÁŽNÍ NÁVOD
NÁVOD K POUŽITÍ |
| SI | NAVODILA ZA MONTAŽO
NAVODILA ZA UPORABO | PT | INSTRUÇÕES DE MONTAGEM
MANUAL DO USUÁRIO |
| ES | INSTRUCCIONES DE MONTAJE
MANUAL DEL USUARIO | HR | UPUTE ZA MONTAŽU
UPUTE ZA UPOTREBU |



0064

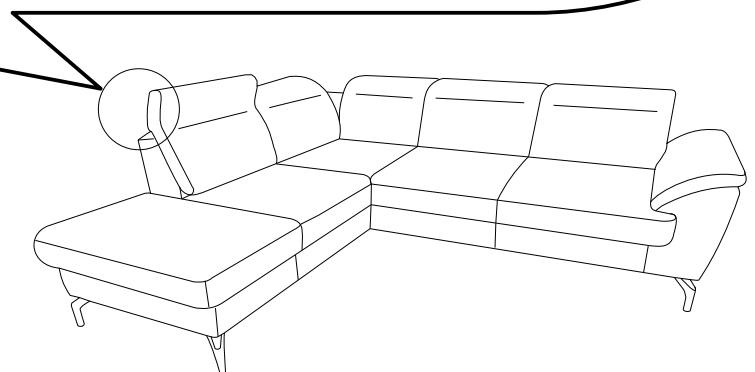
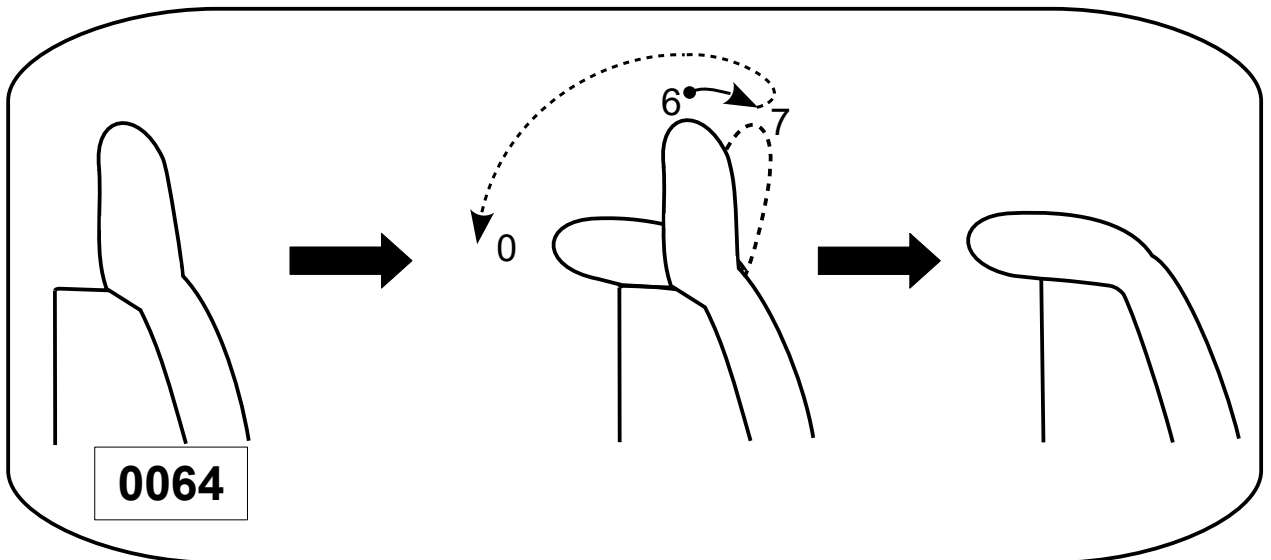
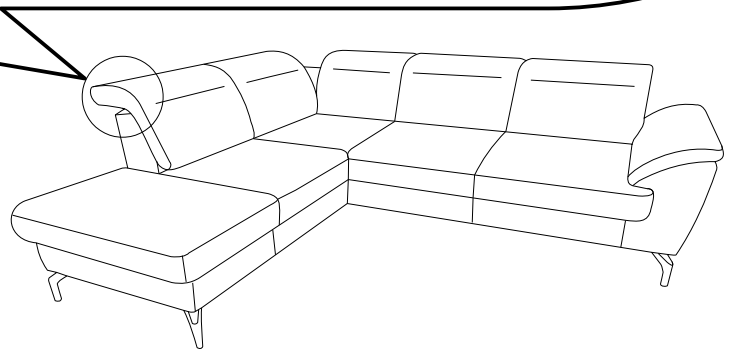
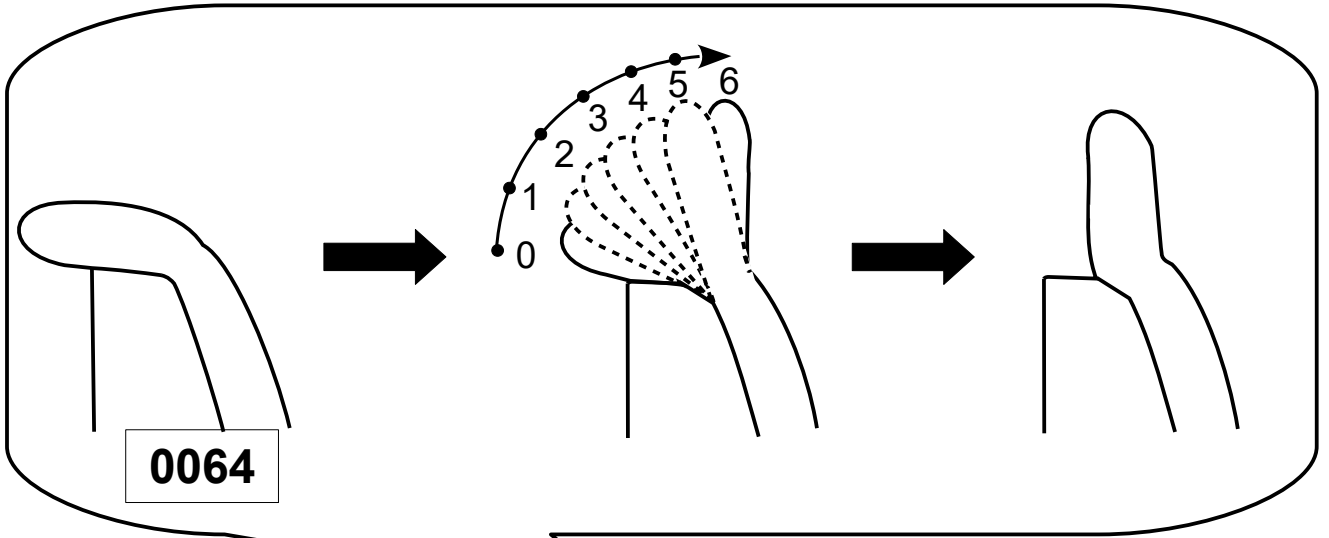

L

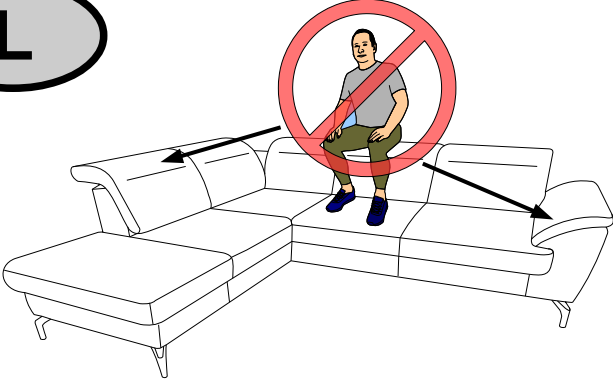

R

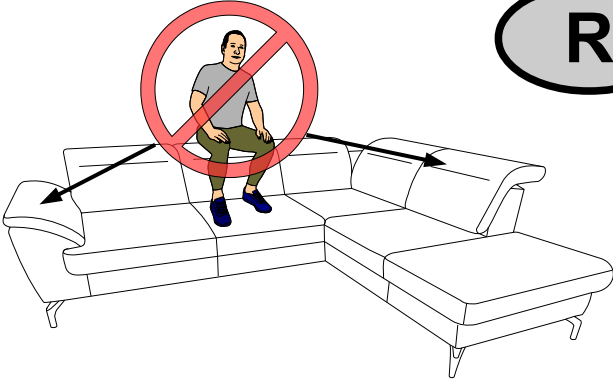



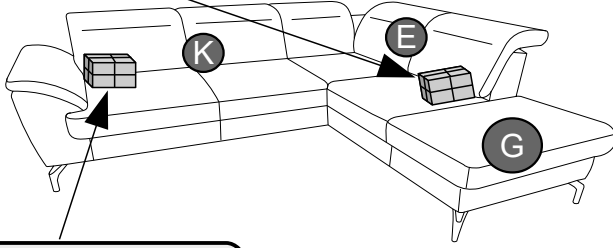
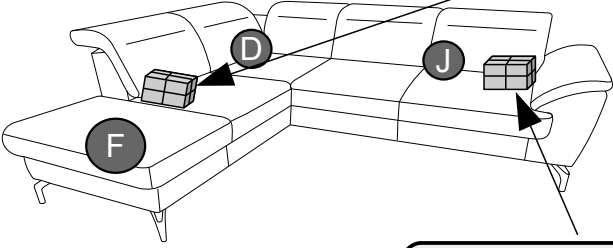

y _{H-120/150} X1	Z _{H-120/150} X3	X _{H-120/150} X3	q M6*25 X12	i L-4 X1	[mm]
---	---	---	---------------------------	------------------------	------

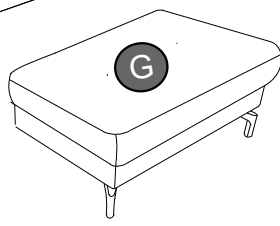
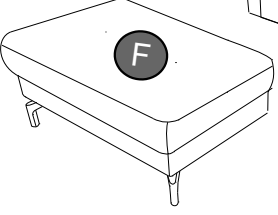
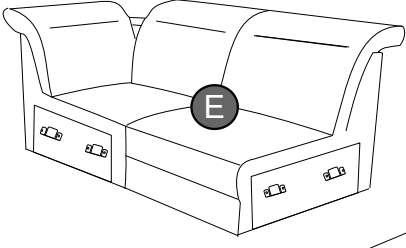
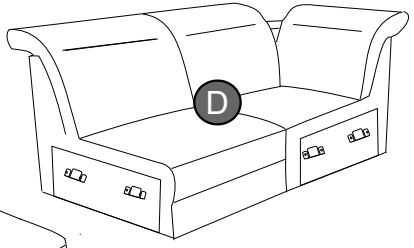
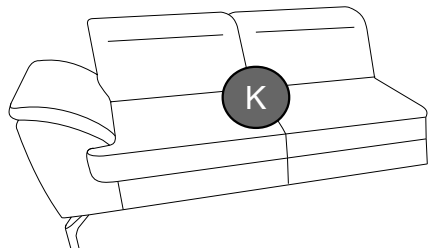
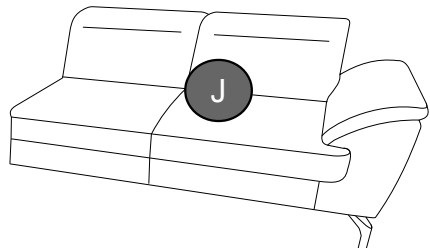

Z _{H-120/150} X2	X _{H-120/150} X2	q M6*25 X8	i L-4 X1
---	---	--------------------------	------------------------



y ^{H-120/150} 	Z ^{H-120/150} 	X ^{H-120/150} 	q M6*25 	i L-4 
X1	X5	X5	X20	X1

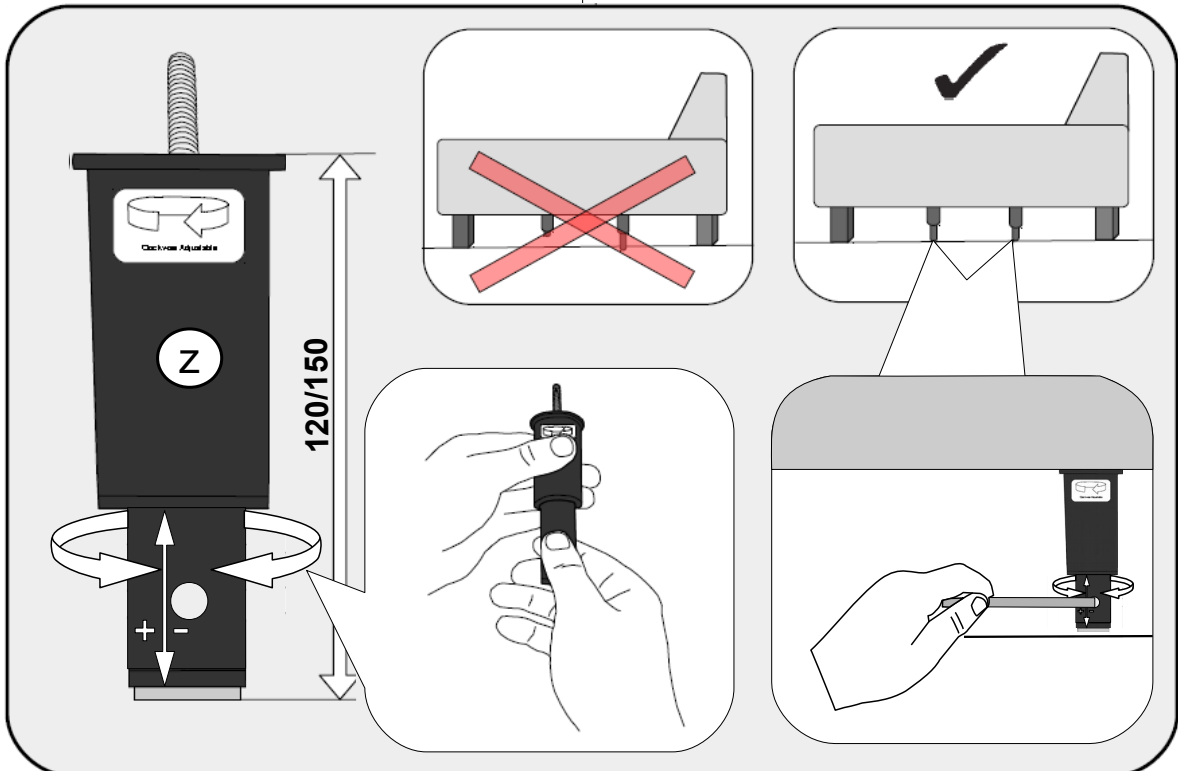
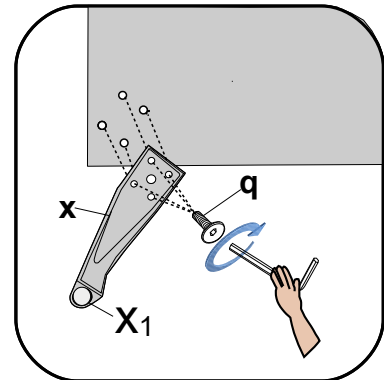
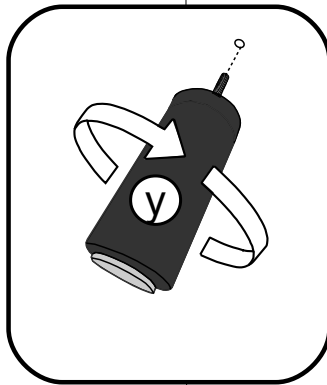
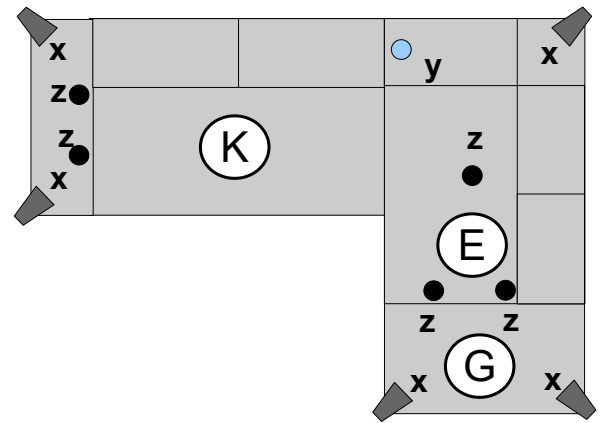
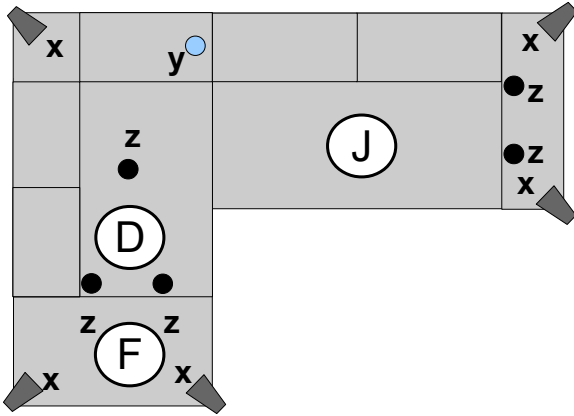
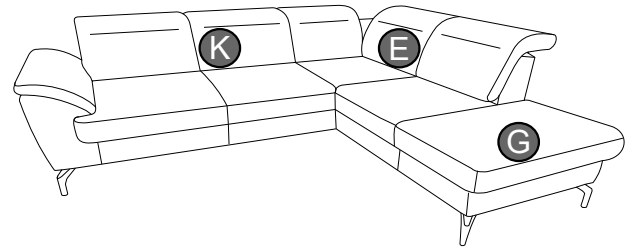
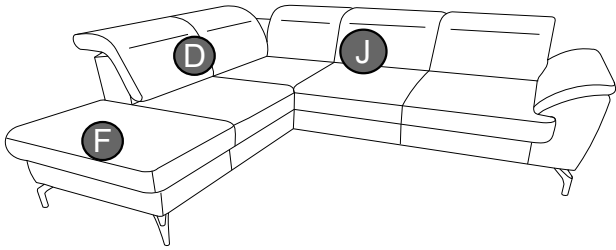

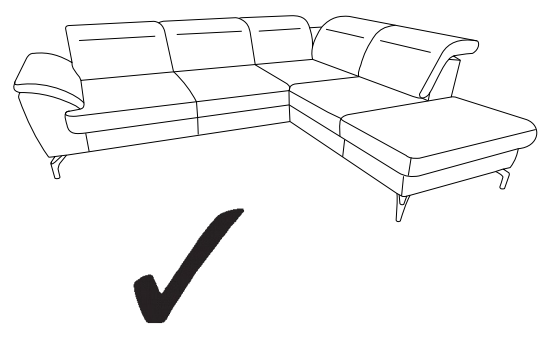
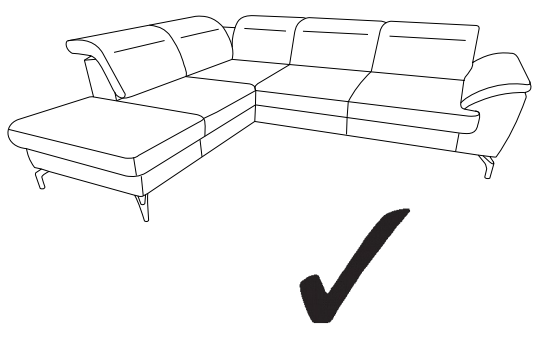
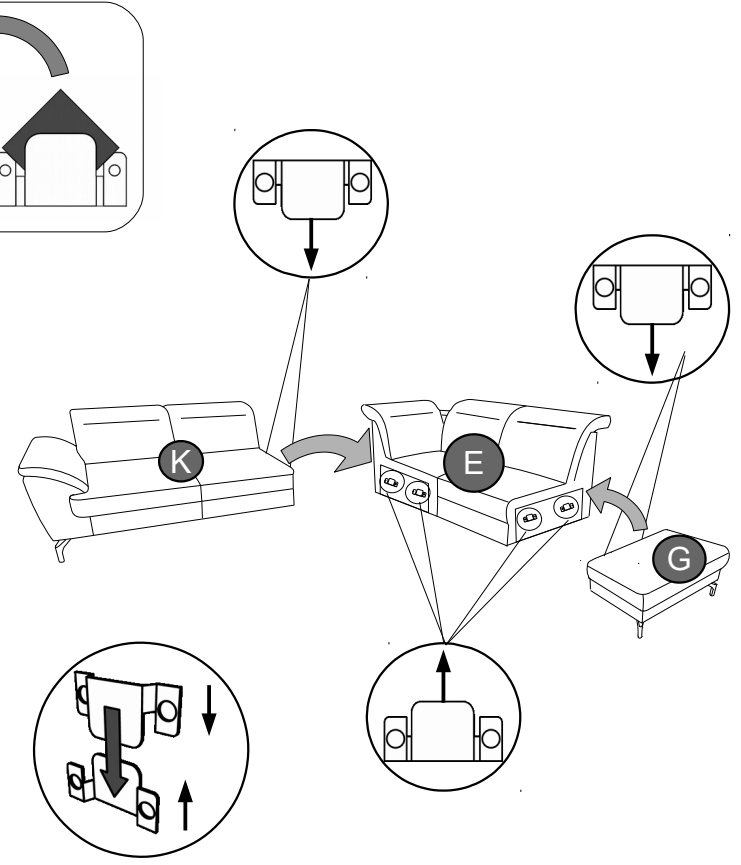
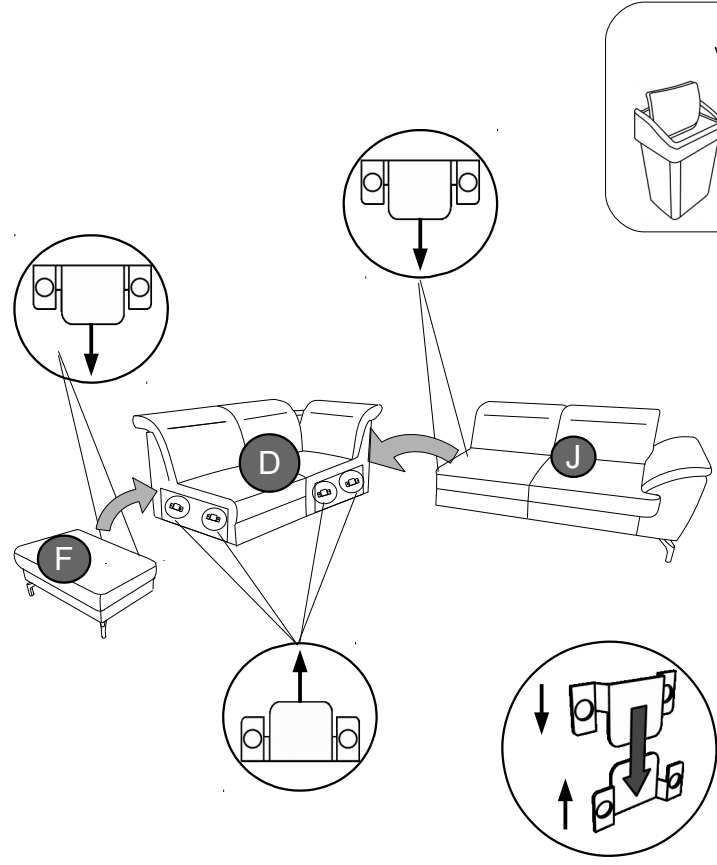

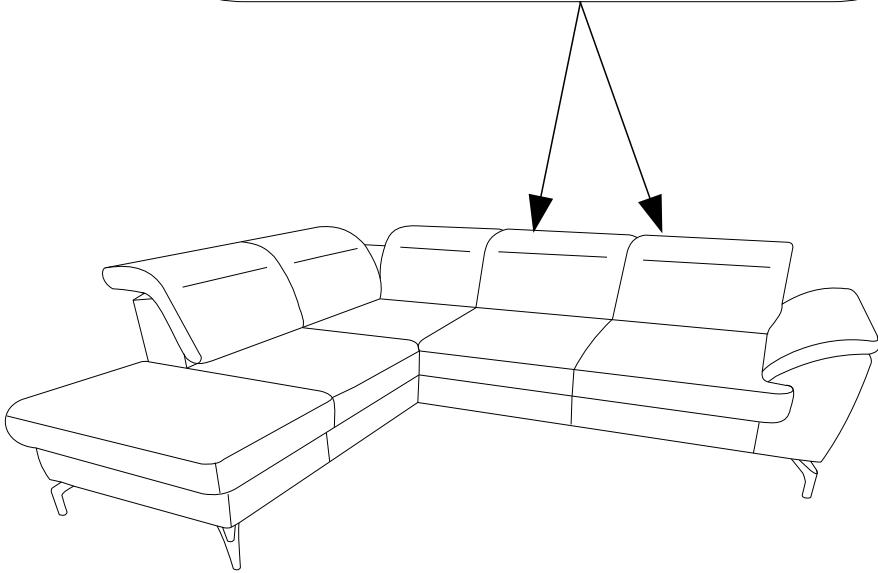
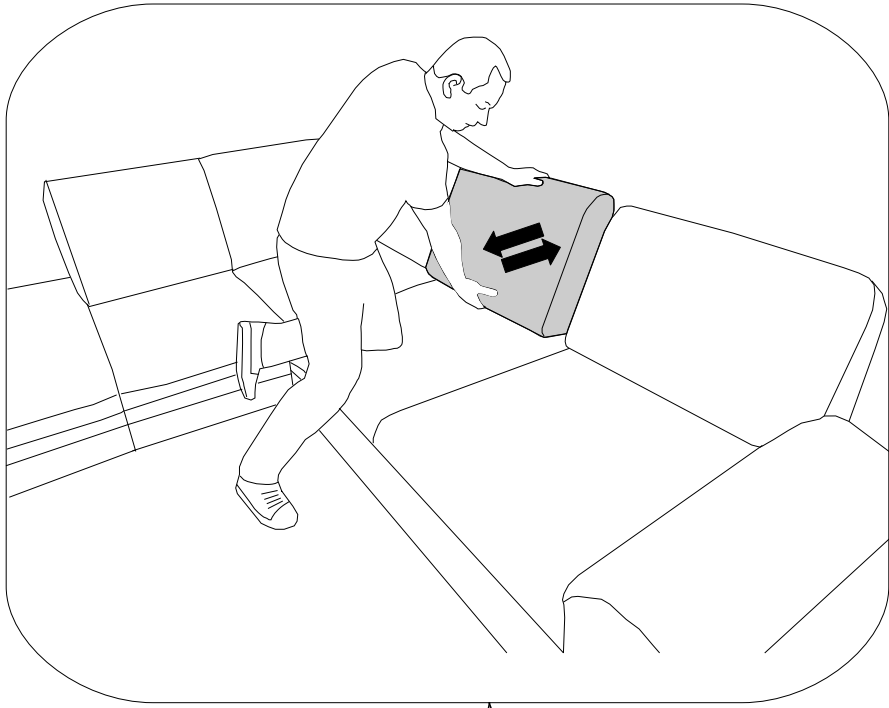

Name · Naam · Nazwa · İsim · Название · Nume · Nome · Názov · Názov ·
 Název · Neve

PERCY V

Typ · Type · Tip · Тип · Tipo · Típus

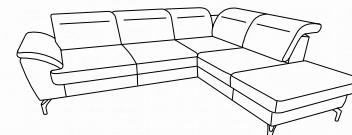
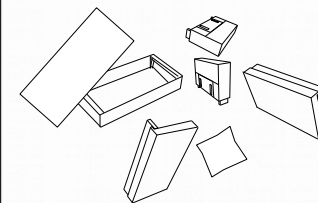
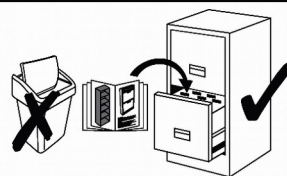

L

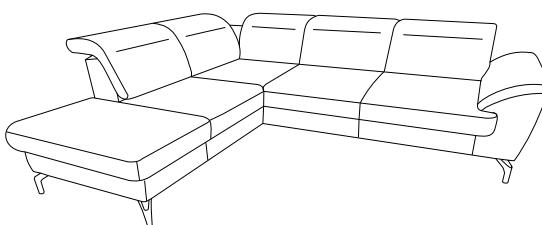

R

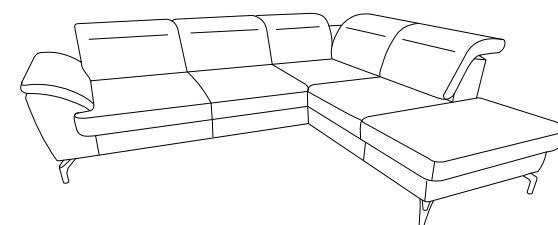

y _{H-120/150} 	Z _{H-120/150} 	X _{H-120/150} 	q M6*25 	i L-4 [mm]
-----------------------------------	-----------------------------------	-----------------------------------	--------------------	-----------------------

