

8

MAX 10 Kg

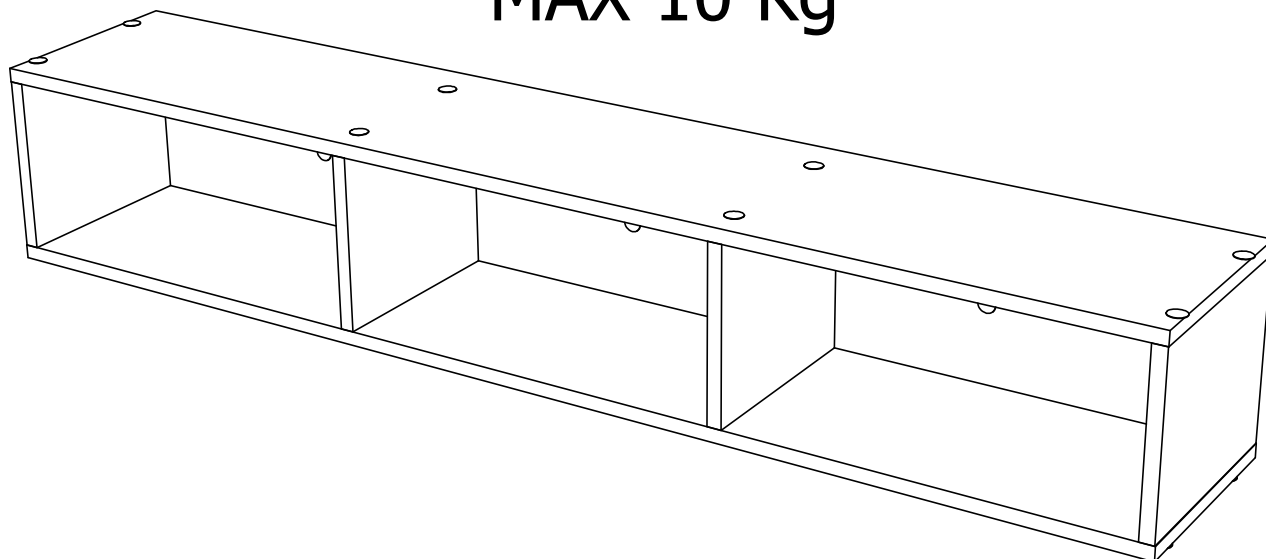

DE

Montageanleitung

GB USA

Assembly instructions

FR

Notice de montage

IT

Istruzione di montaggio

NL

Handleiding voor de montage

PL

Instrukcja montażu

CZ

Montážní návod

SK

Návod na montáž

HU

Szerelési útmutató

RO

Instrucțiuni de montaj

TR

Montaj talimatı

RU

Инструкция по монтажу

PT

Instruções de montagem

ES

Instrucciones de montaje

AR

تعليمات التجميع

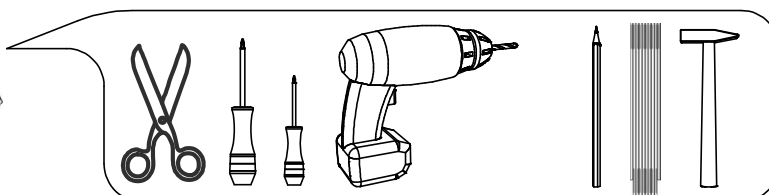
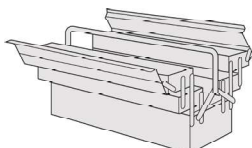
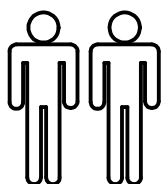

# Service • Dienstverlening • Serwis • Servis • Сервисная служба • Servizio

Name • Naam • Nazwa • İsim • Название • Nom • Nome

Nr. • No. • Номер • Nu.

Тур • Туре • Тір • Тип • Тіро

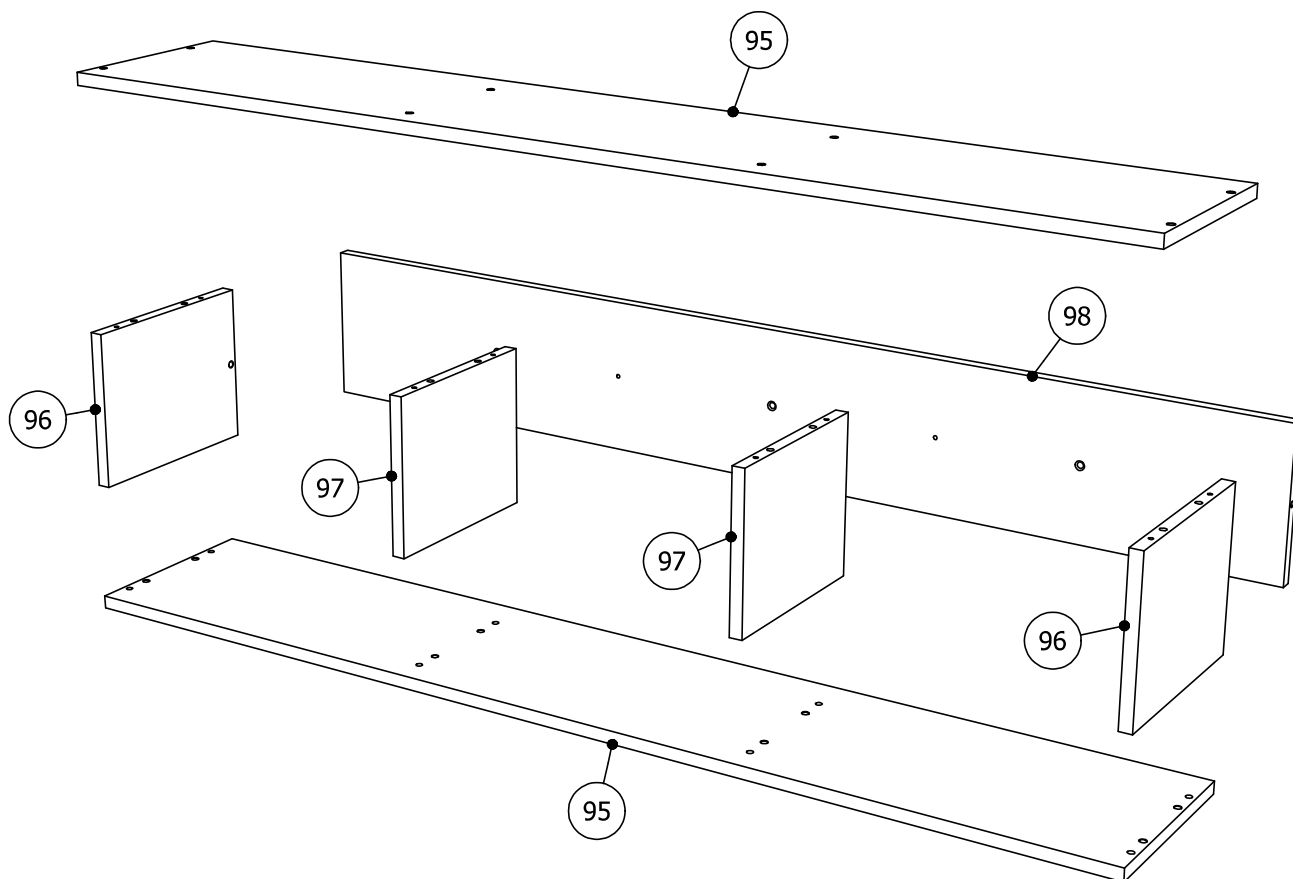
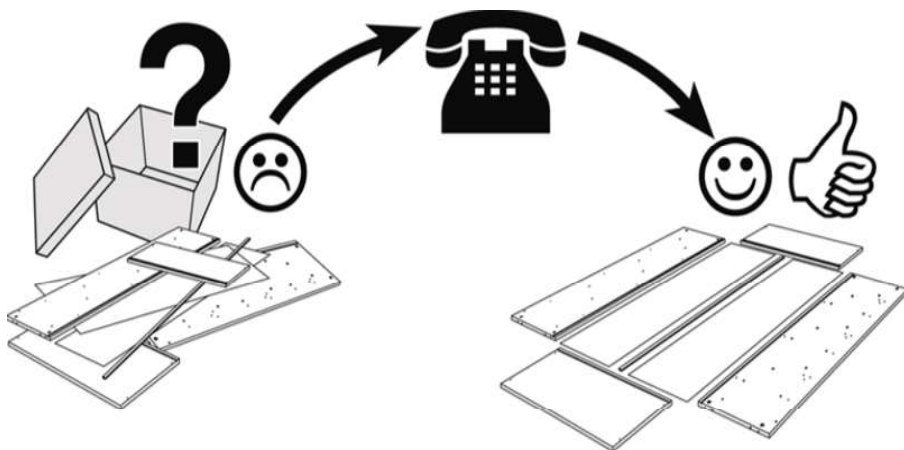

Code	Qt.	Dimensions	Box
95	2	1400x250x16	1-1
96	2	200x250x16	1-1
97	2	200x234x16	1-1
98	1	1367x200x16	1-1

12

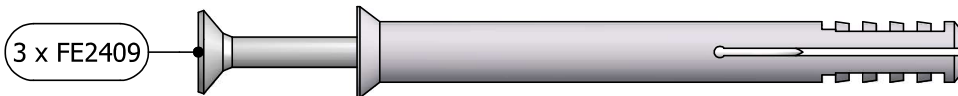
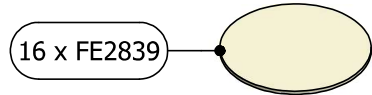
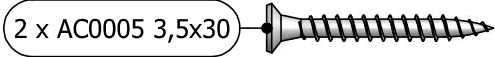
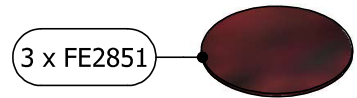
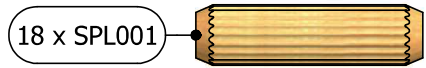
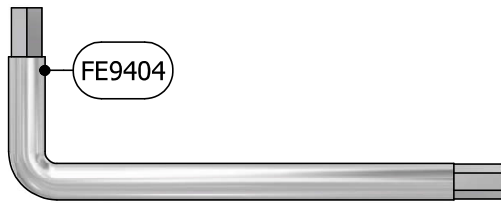

13

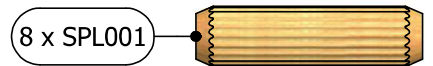
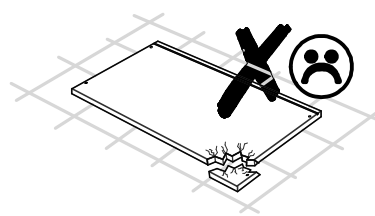
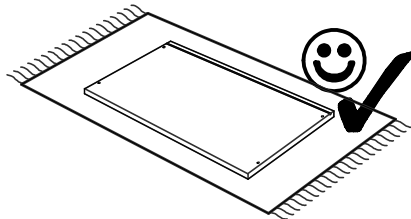

2x

