



 Befestigung der Kabel

 fixing the cable

 la fijación del cable

 fixation du cable

 bevestiging van de kabel

 fissaggio del cavo

 Ofen • Innen

 Oven • inside

 Horno • interior

 Four • a l'intérieur

 Oven • binnen

 Forno • interno

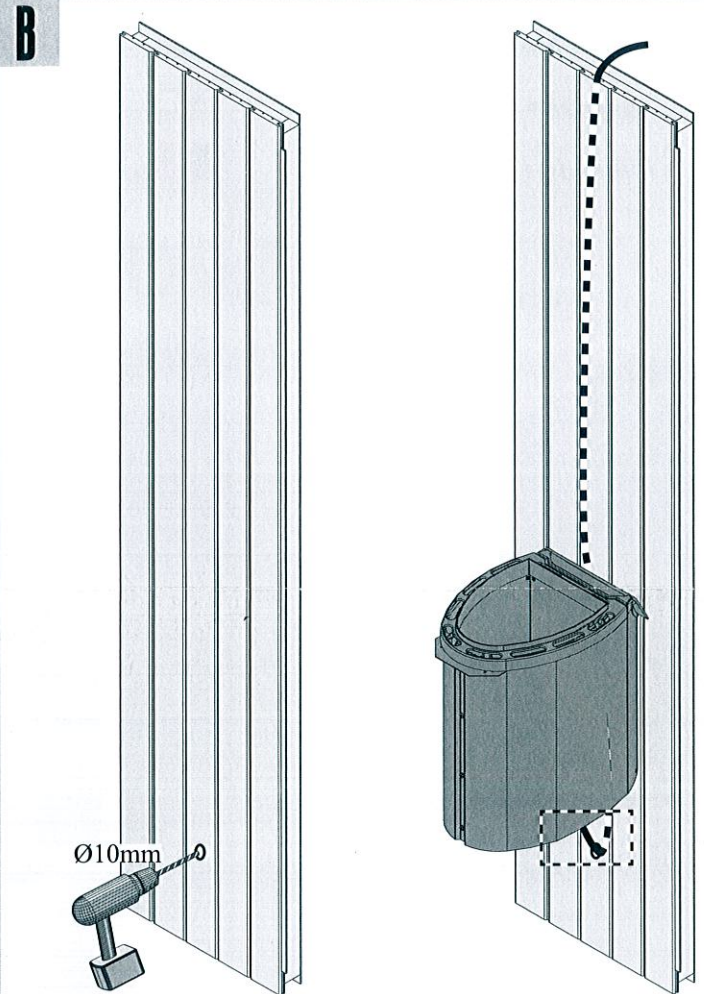
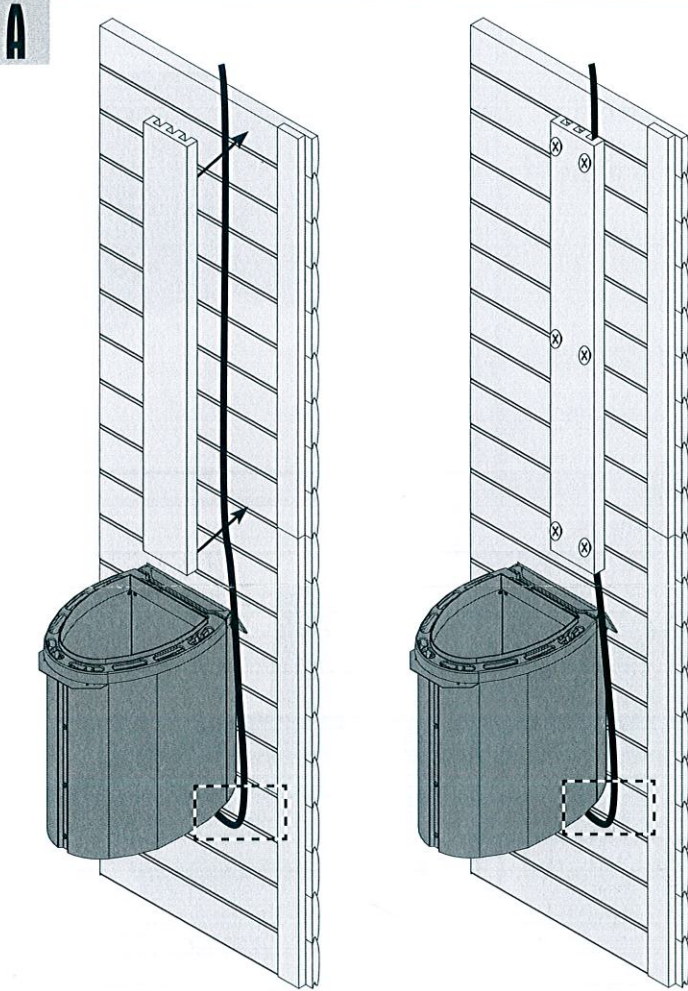

 Befestigung der Kabel

 fixation du cable

 fixing the cable

 bevestiging van de kabel

 la fijación del cable

 fissaggio del cavo

 Lampe • Innen

 lampe • a l'intérieur

 lamp • inside

 lamp • binnen

 lámpara • interior

 lampada • interno

 Steuergerät • Außen

 unité de controle • en dehors

 control unit • outside

 controle-eenheid • buiten

 unidad de control • fuera

 unità de controllo • al di fuori

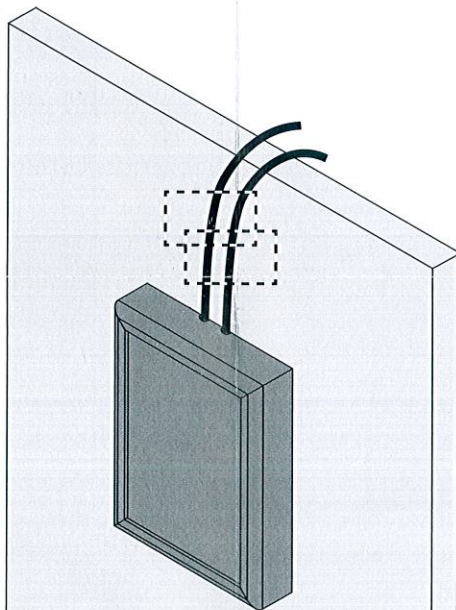
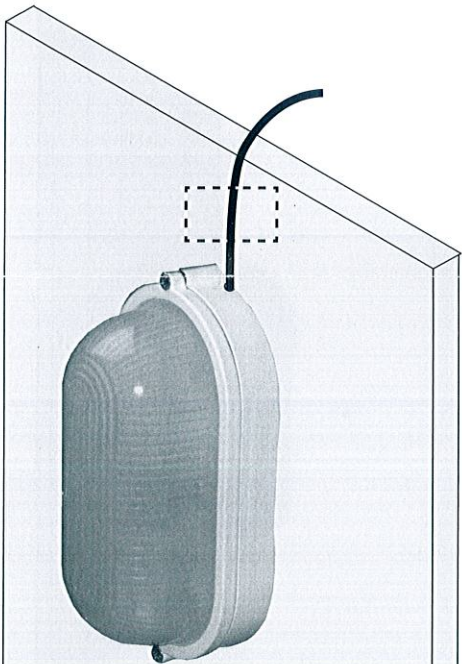

1



2

