

TRADE POINT Germany GmbH
Am Bahnhof 14
D-26655 Westerstede

D- Montageanleitung

GB- Assembly instructions

F- Instructions de montage

PL- Instrukcja montażu

RU- Инструкция по монтажу

NL- Montagehandleiding

TR- Montaj talimatı

RO- Instrucțiuni de montaj

IT- Istruzioni per il montaggio

SK- Návod na montáž

CZ- Návod k montáži

HU- Szerelési útmutató

BG- Ръководство за монтаж

P- Instruções de montagem

ES- Instrucciones de montaje

SRB- Uputstvo za montažu

SLO- Navodila za vgradnjo

HR- Upute za montažu

LT- Montavimo instrukcija

LV- Montāžas instrukcija

EST- Montaažijuhend





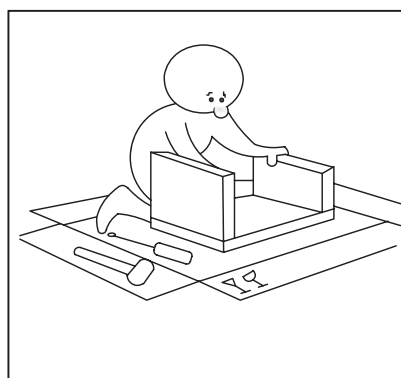
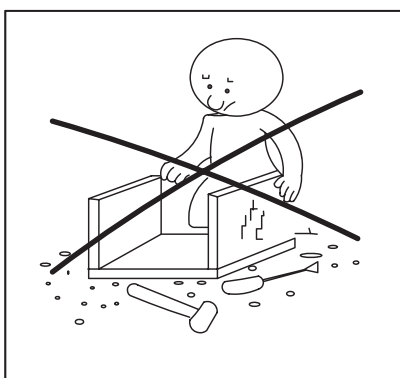
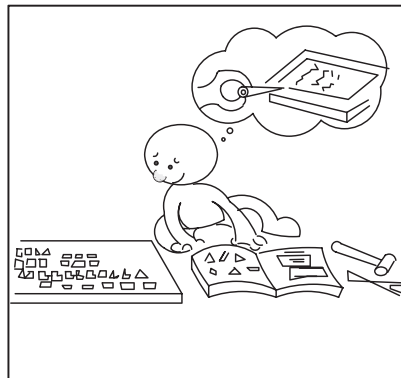
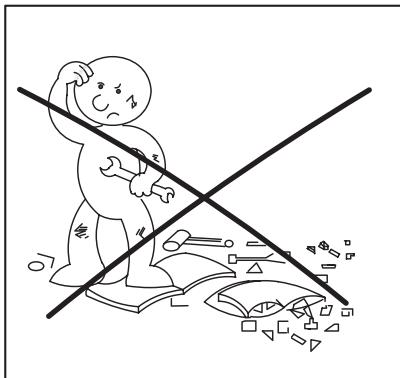
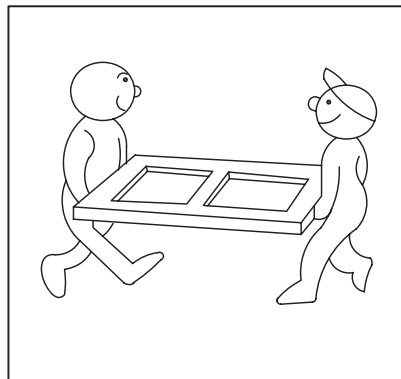
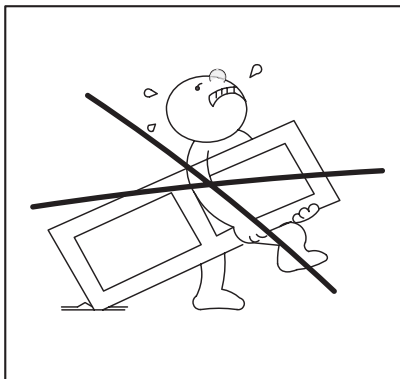
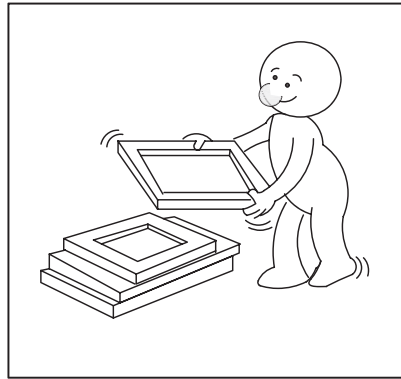
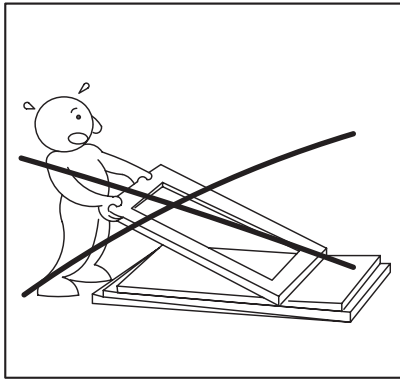
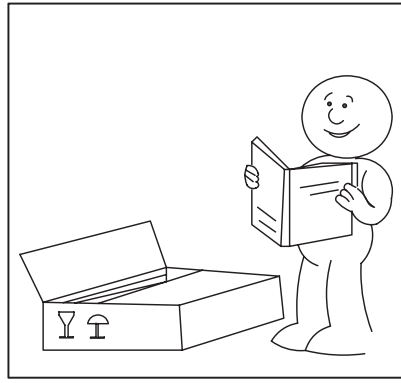
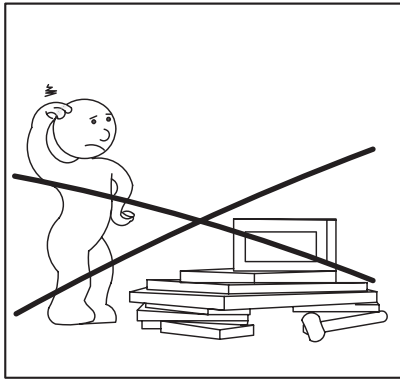





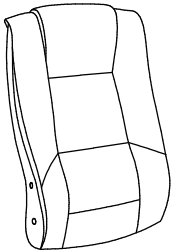

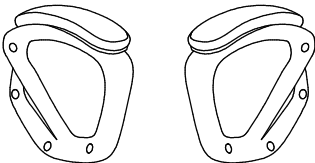
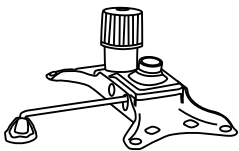
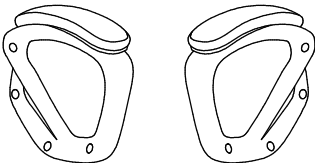
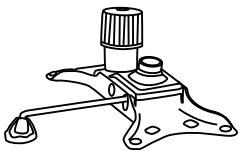
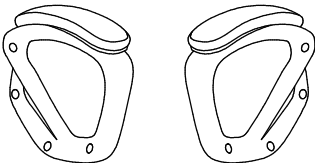
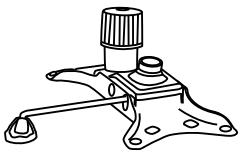
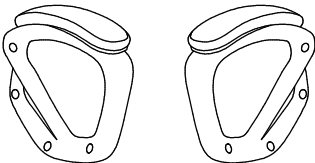
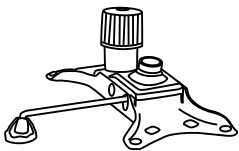
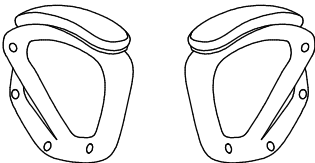
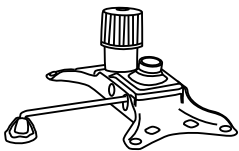
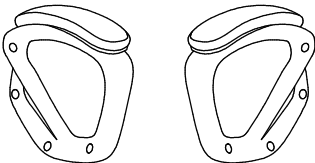
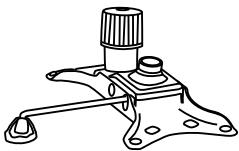

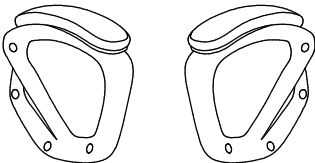
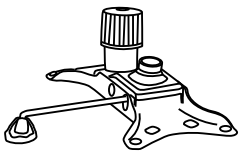
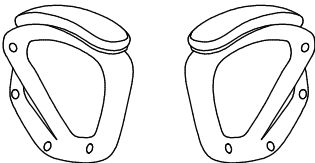
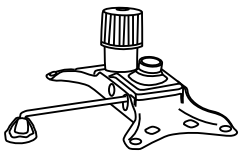
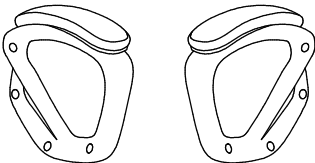
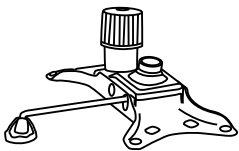
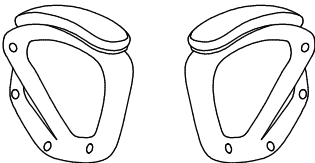
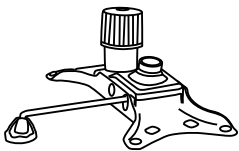
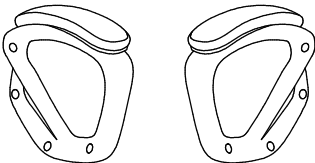
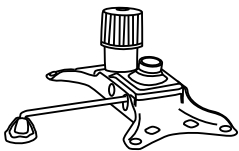
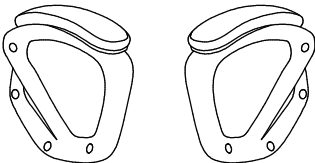
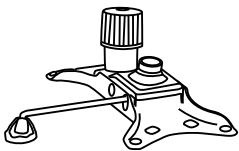

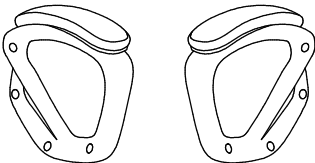
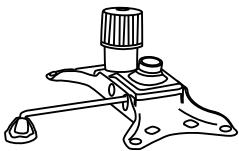
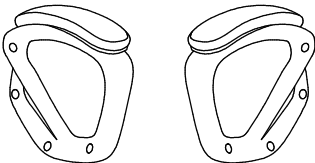
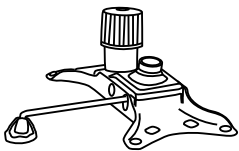
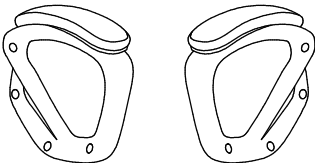
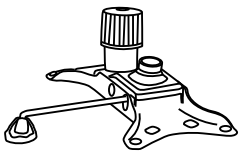
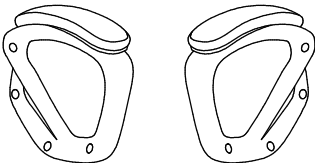
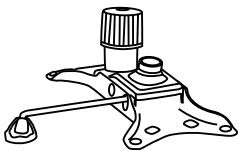
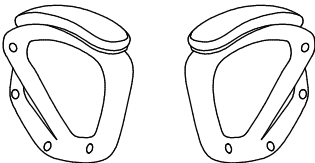
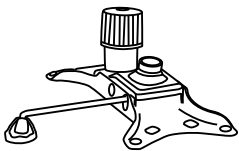
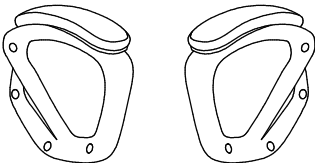
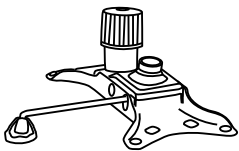

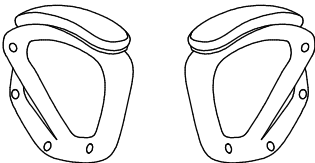
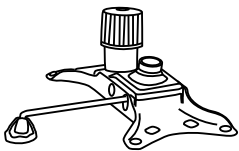
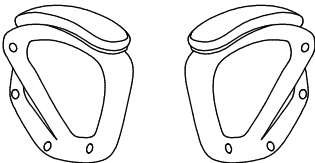
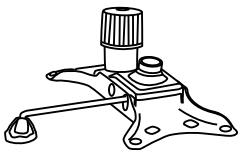
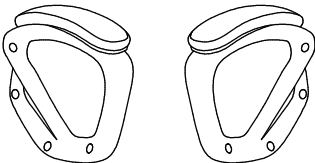
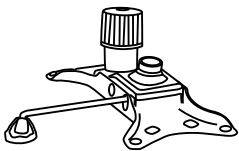
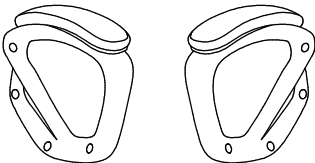
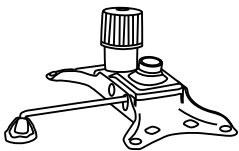
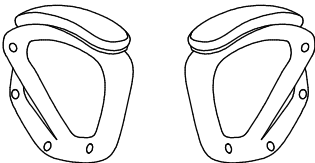
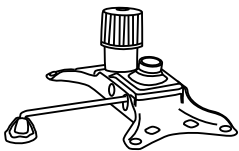
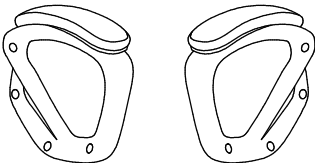
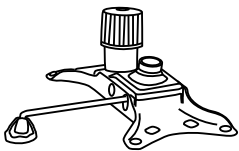

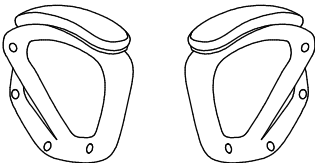
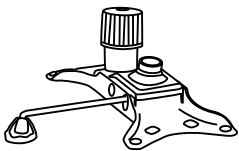
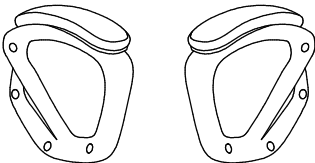
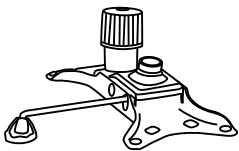
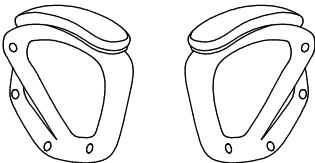
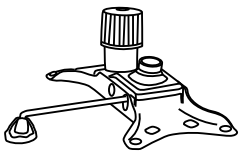
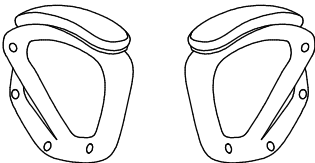
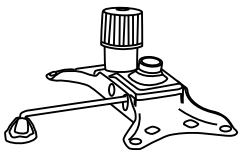
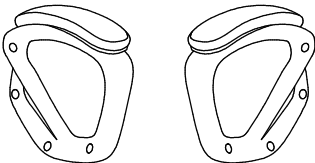
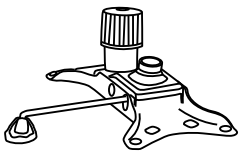
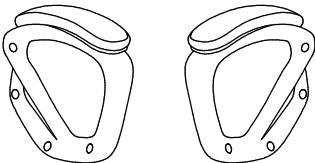
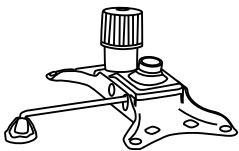

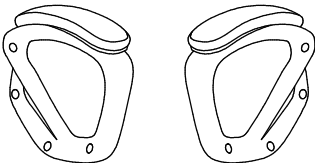
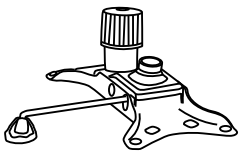
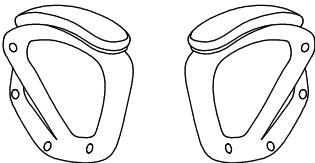
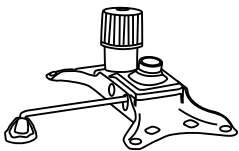
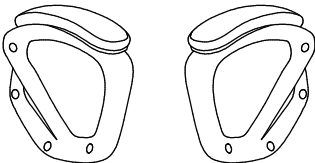
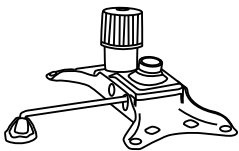
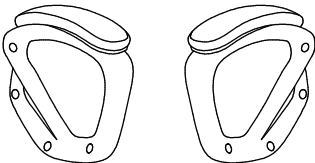
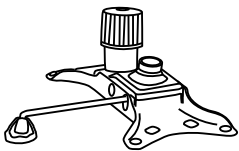
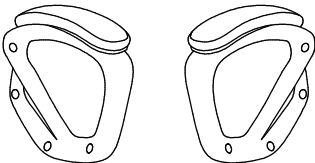
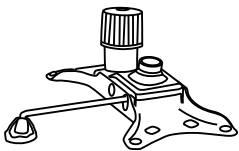
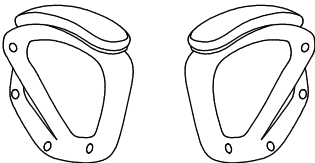
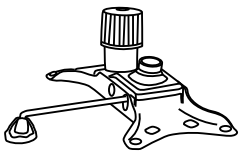

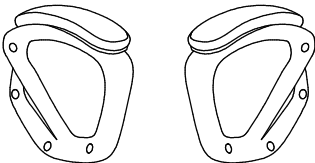
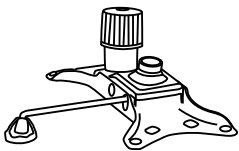
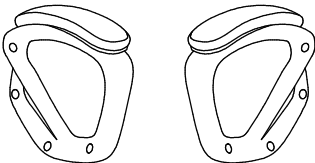
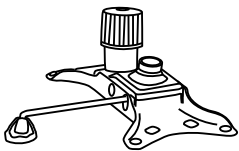
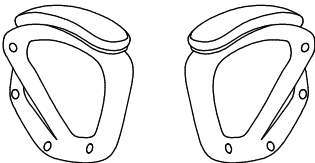
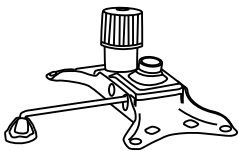
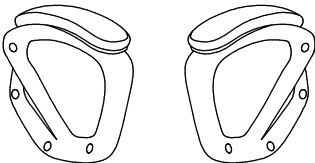
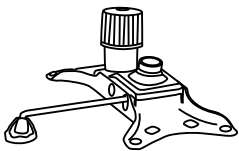
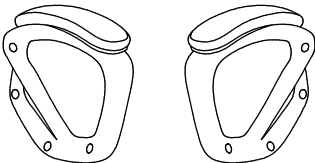
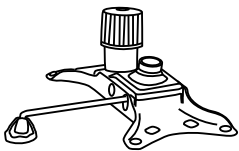
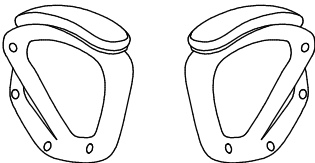
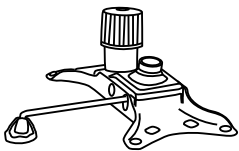

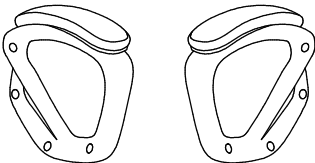
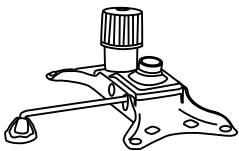
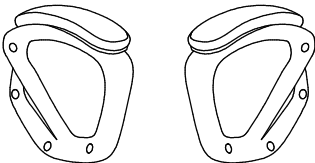
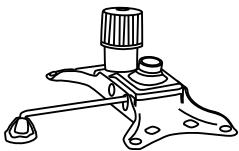
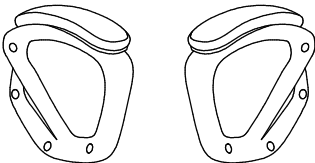
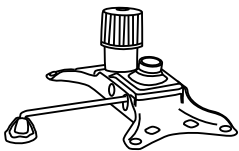
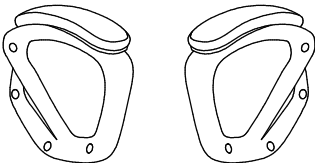
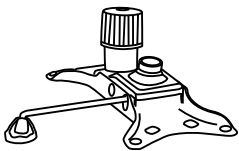
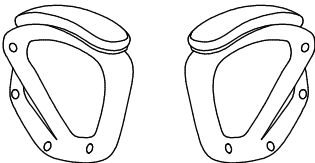
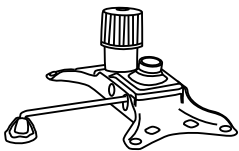
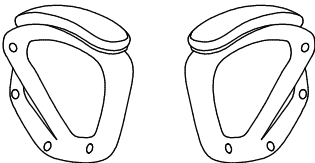
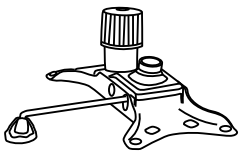

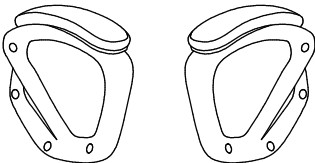
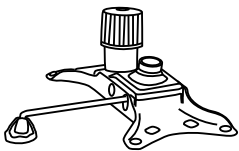
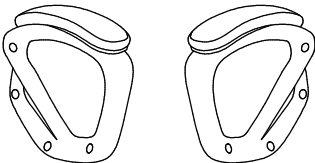
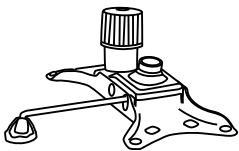
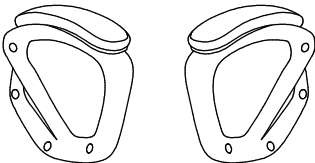
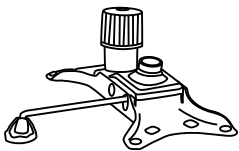
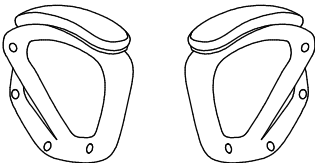
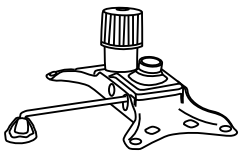
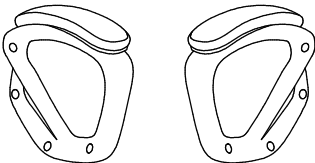
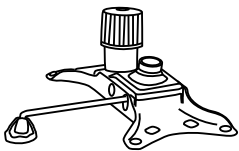
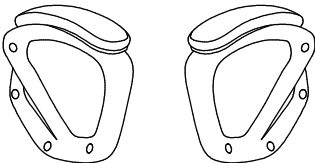
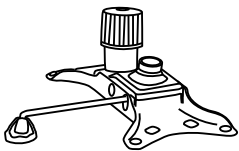

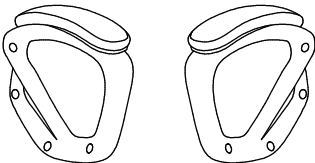
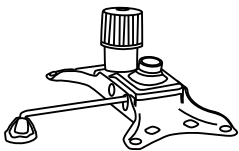
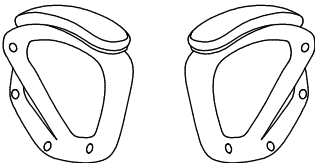
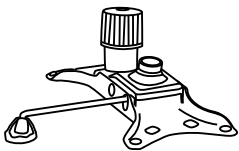
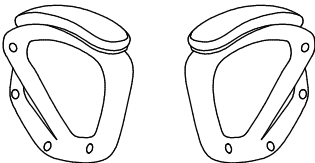
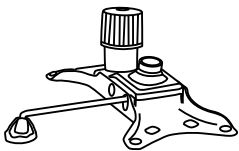
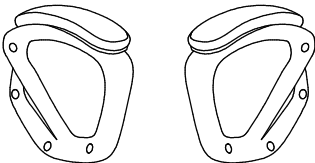
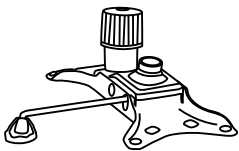
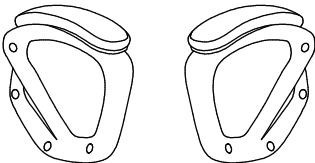
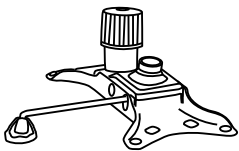
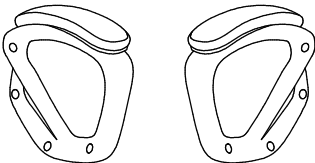
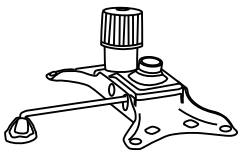

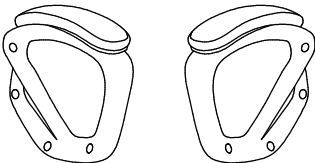
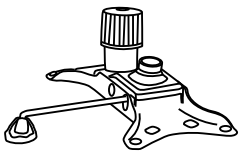
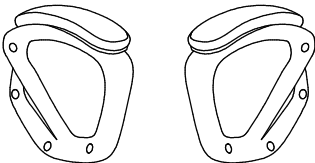
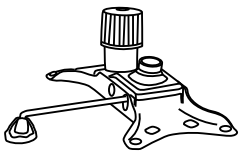
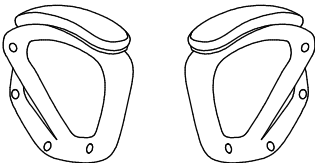
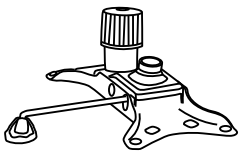
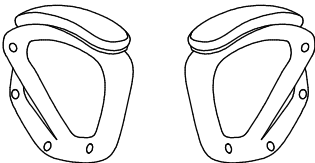
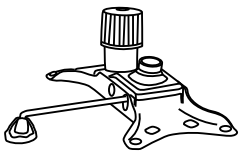
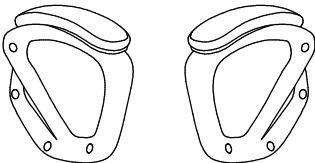
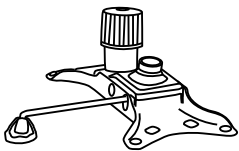
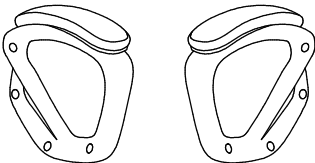
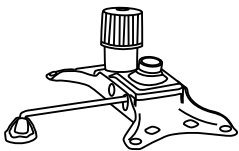

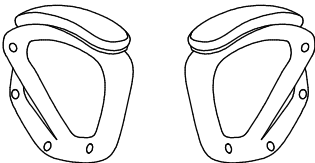
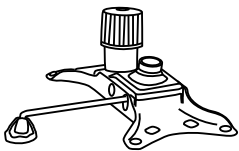
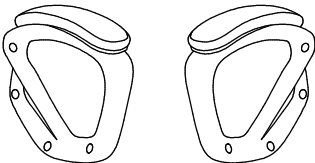
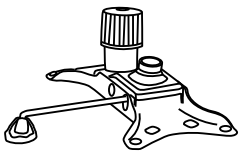
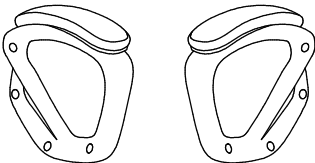
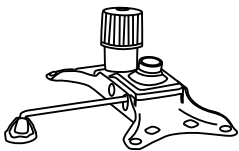
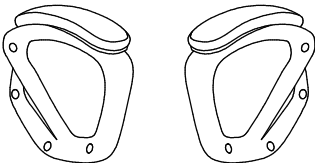
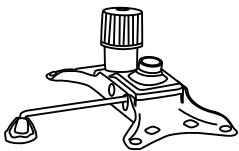
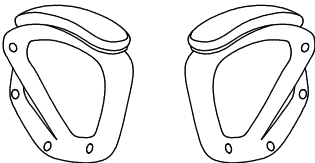
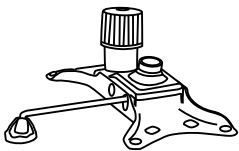
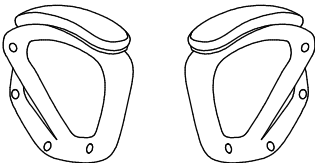
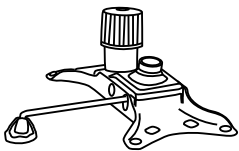

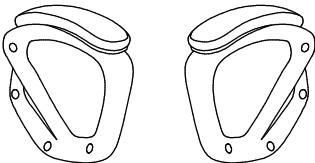
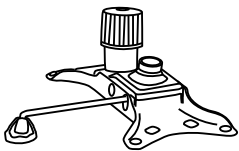
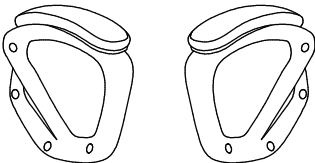
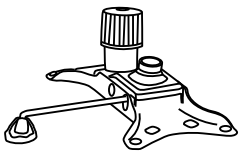
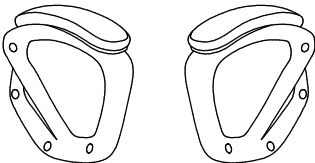
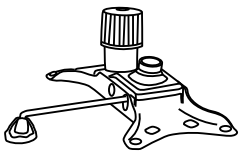
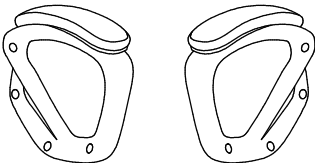
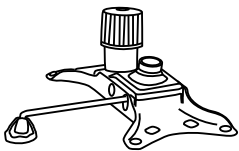
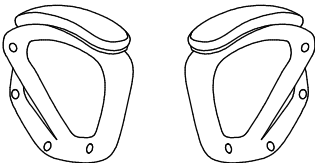
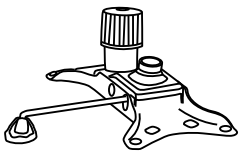
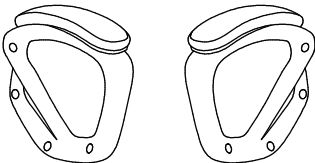
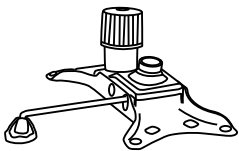

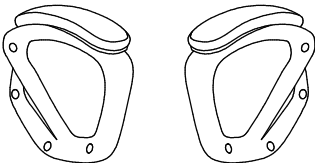
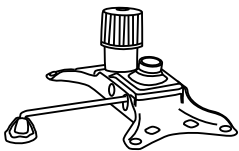
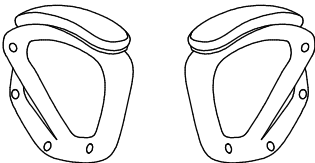
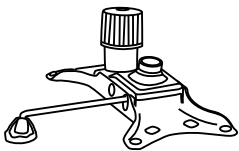
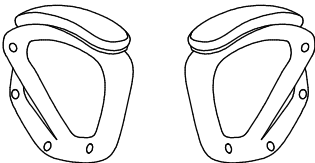
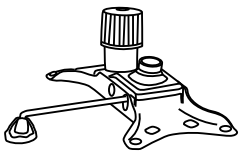
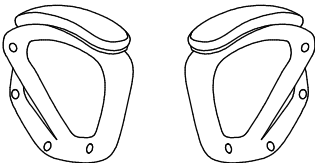
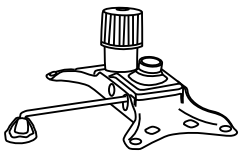
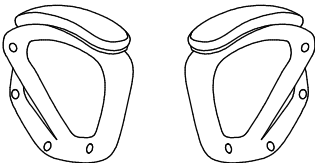
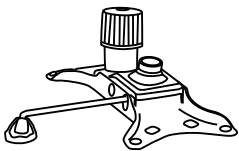
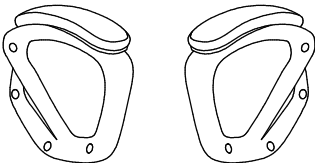
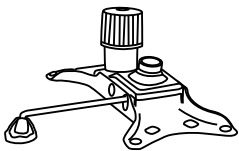

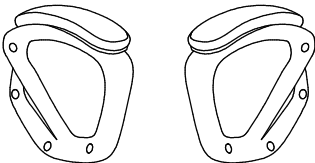
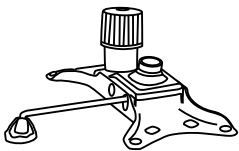
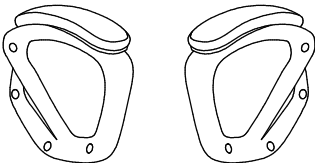
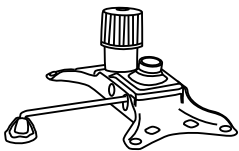
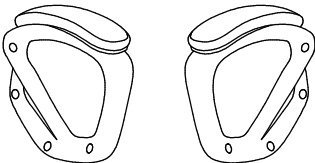
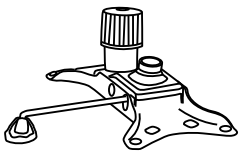
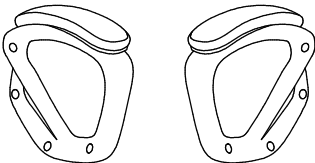
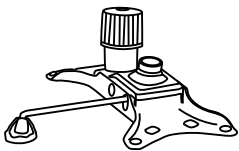
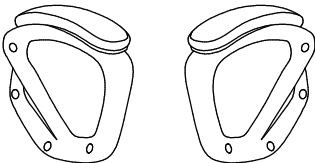
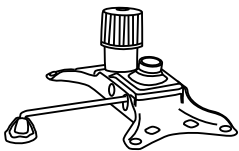
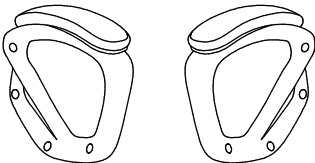
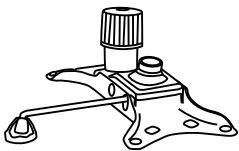

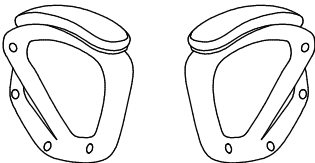
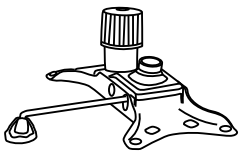
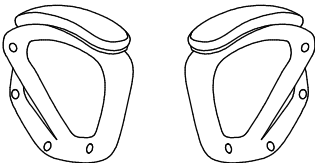
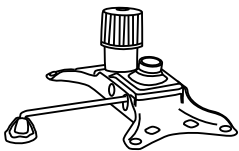
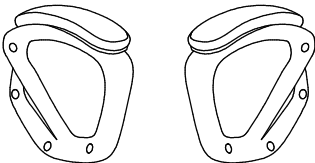
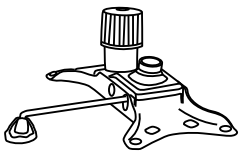
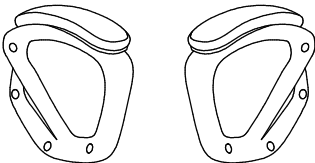
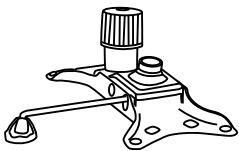
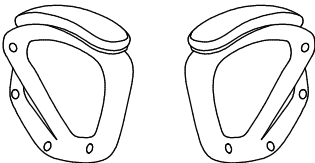
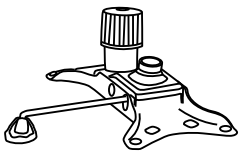
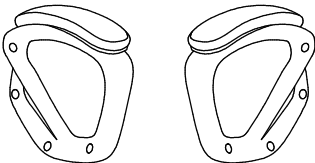
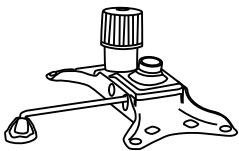

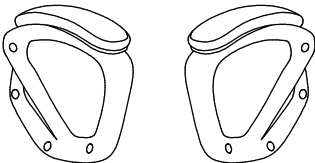
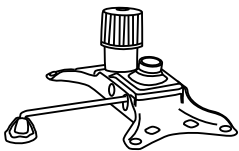
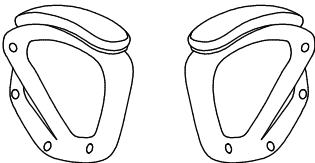
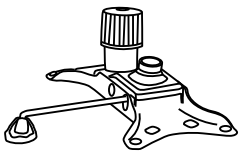
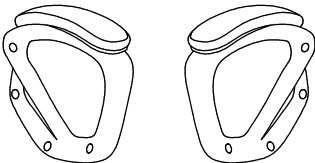
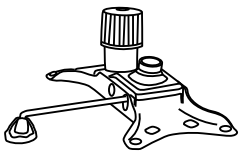
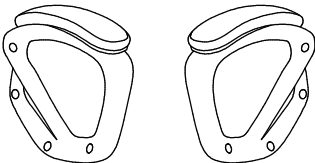
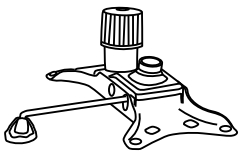
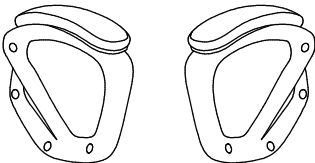
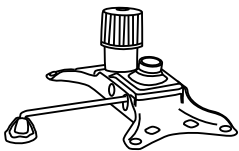
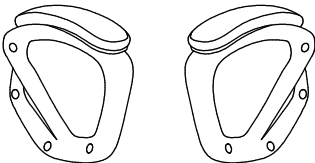
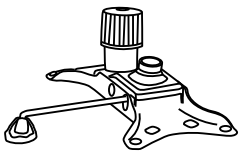
S- Monteringsanvisning

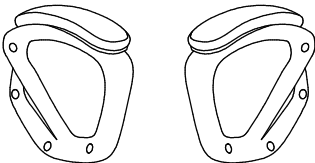
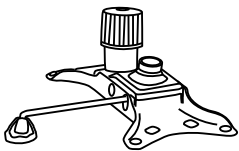
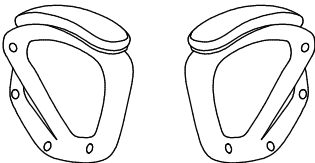
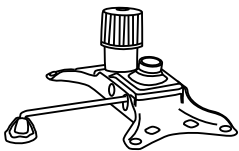
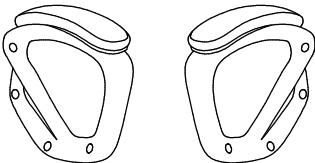
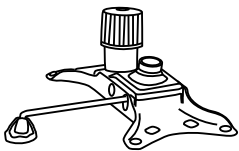
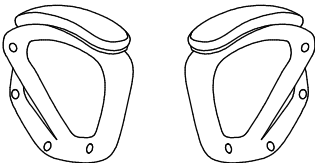
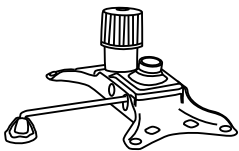
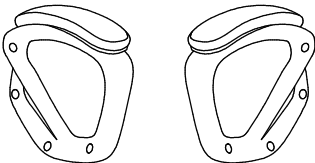
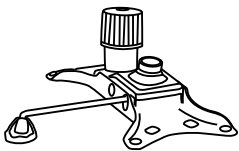
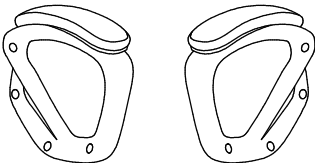
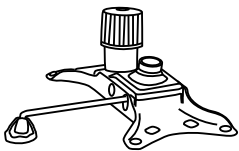

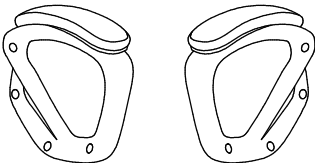
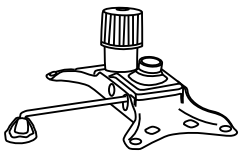
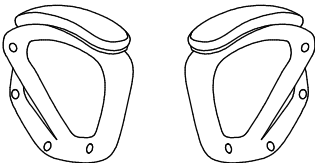
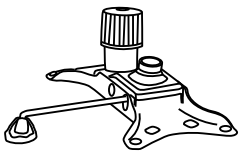
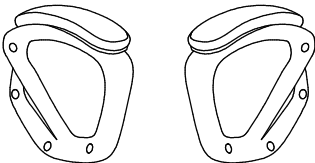
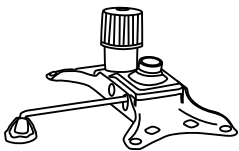
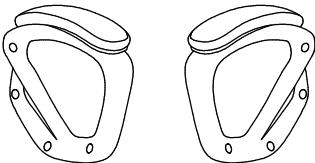
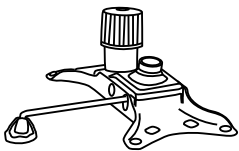
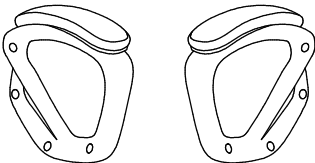
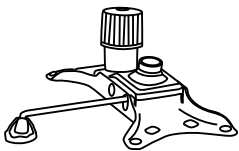
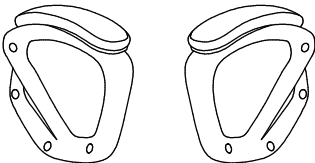
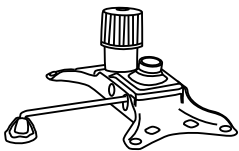

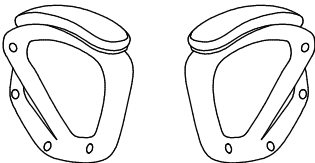
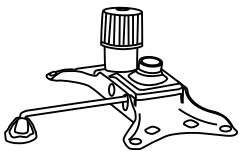
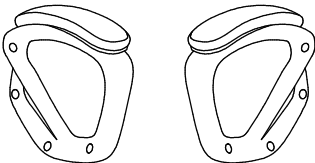
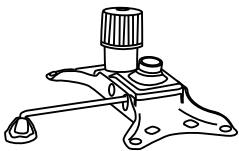
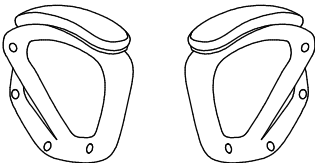
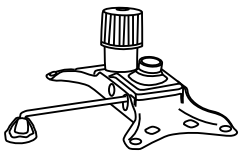
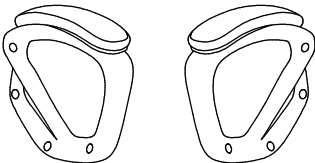
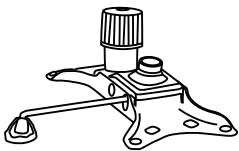
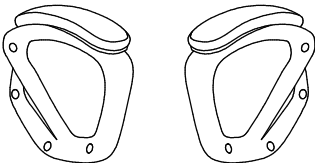
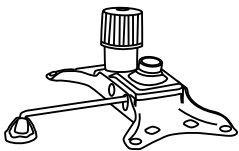
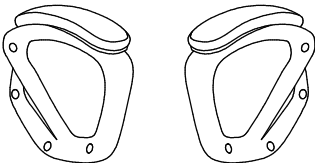
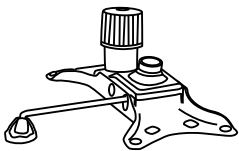
Servicekarte/ Сервизна карта/ Carte service/ Servisní karta/ Service card/ Tarjeta de servicio/ Servisna kartica/ Teeninduskaart/ Szervizlevél/ Servis karti/ Scheda di servizio/ Techninés priežiūros kortelė/ Servisa karte/ Servicekaart/ Servisna kartica/ Cartão de serviços/ Karta serwisowa/ Carte de service/ Сервис-карта/ Servicekort/ Servisna kartica/ Servisná karta

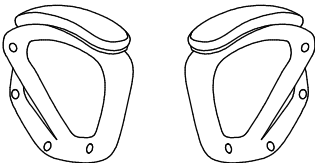
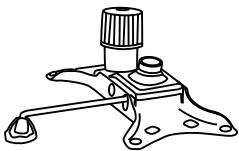
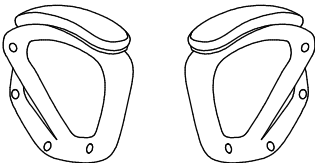
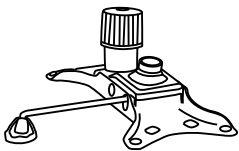
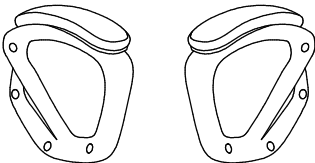
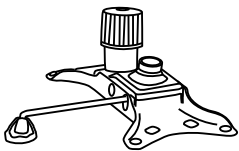
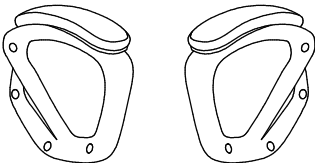
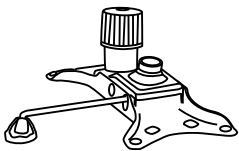
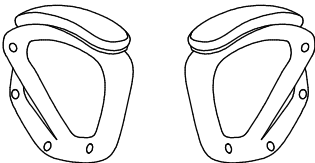
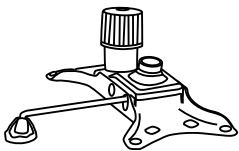
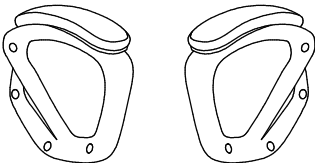
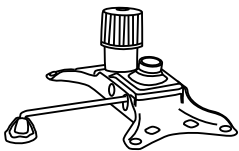
DARYL XXL

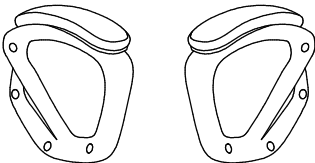
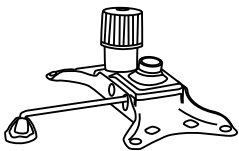
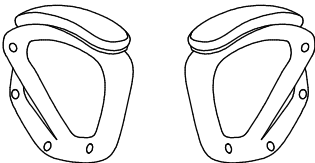
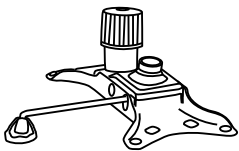
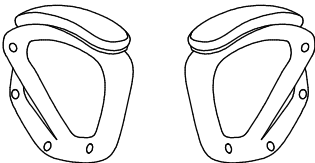
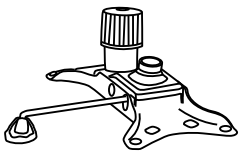
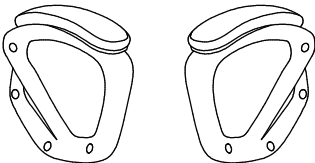
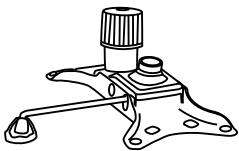

				
				
				
				
				
				
				
				
				
				
				
				
				
				
				
				
				
				
				
				
				
				
				
				
				
				
				
				
				
				
				
				
				
				
				
				
				
				
				
				
				
				
				
				
				
				
				
				
				
				
				
				
				
				
				
				
				
				
				
				
				
				
				
				
				
				
				
				
				
				
				
				
				
				
				
				
				
				
				
				
				
				
				
				
				
				
				
				
				
				
				
				
				
				
				
				
				
				
				
				
				
				
				
				
				
				
				
				
				
				
				
				
				
				
				
				
				
				
				
				
				
				
				
				
				
				
				
				
				
				
				

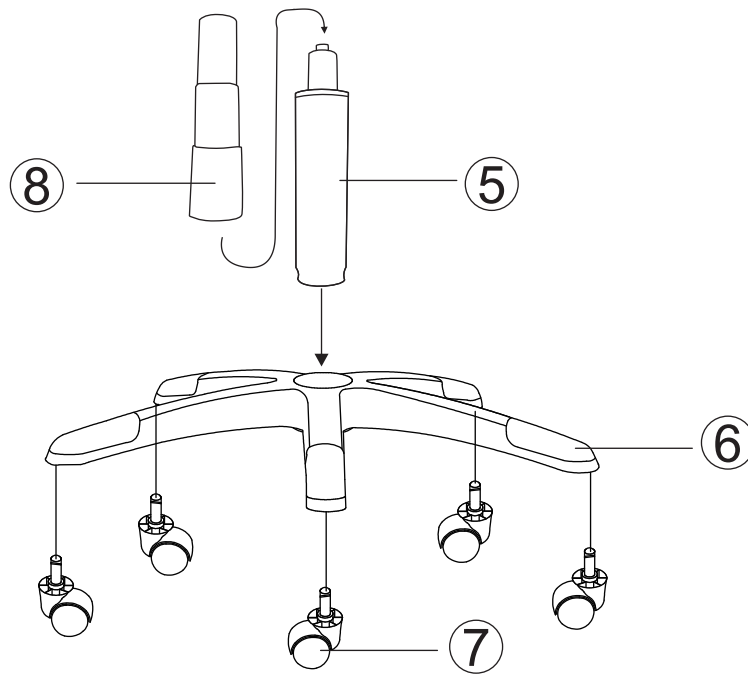

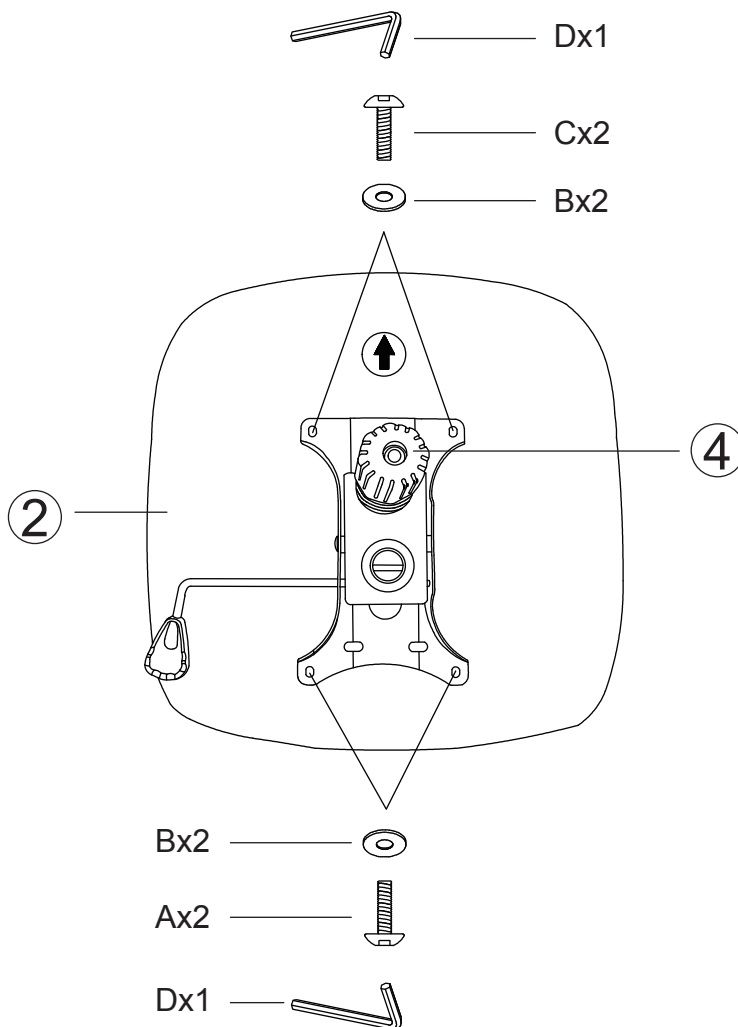

1



2

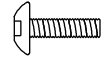

- Bx2 — 
- Ax2 — 
- Dx1 — 

M6X20MM		Ax2
Φ6XΦ18MM		Bx4
M6X30MM		Cx2
M6		Dx1

3

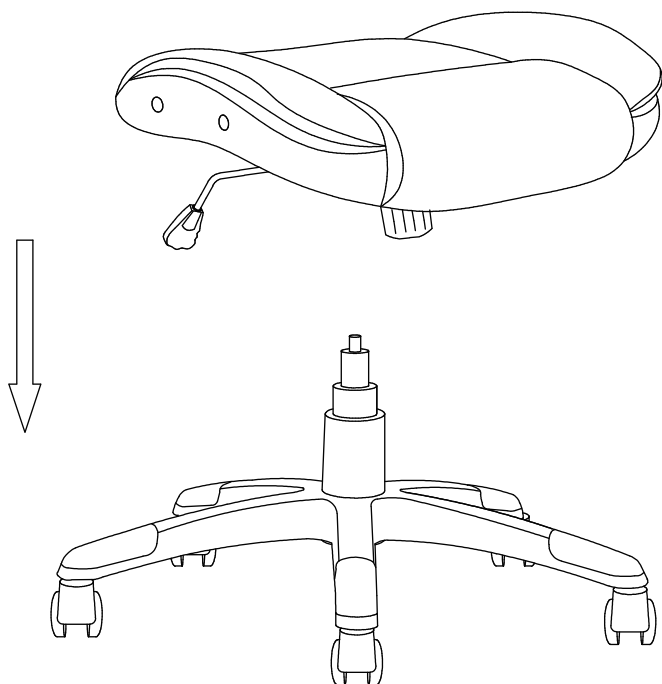

4

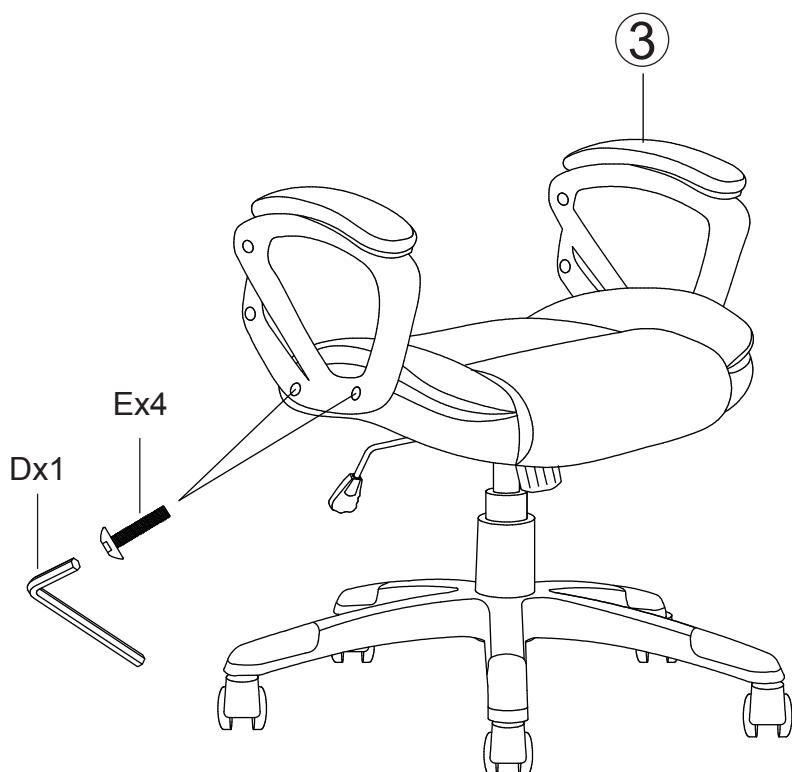

M6



Dx1

M6X25MM



Ex4

5

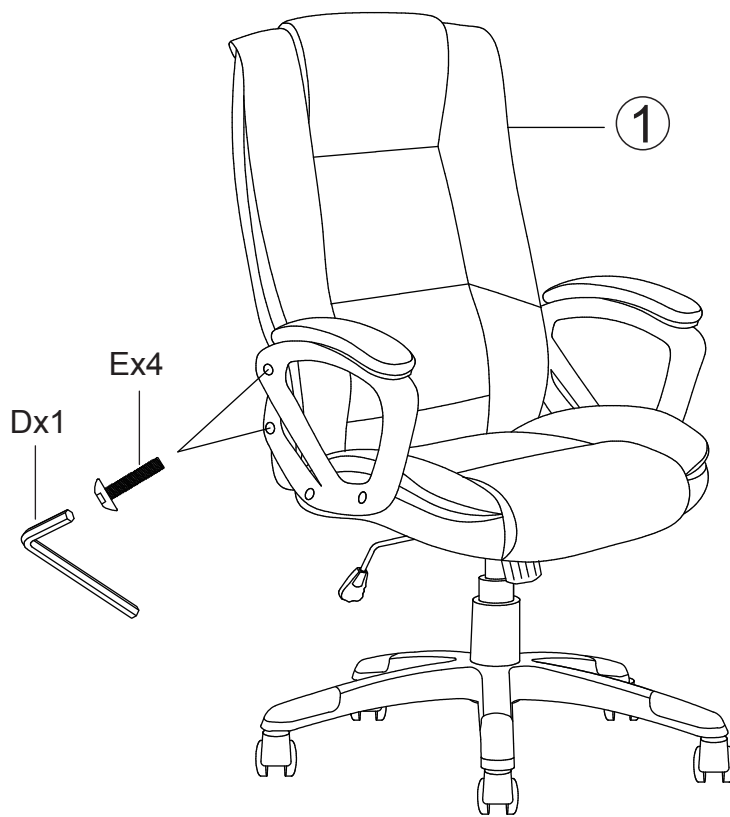

M6



Dx1

M6X25MM

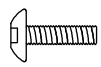

Ex4

6

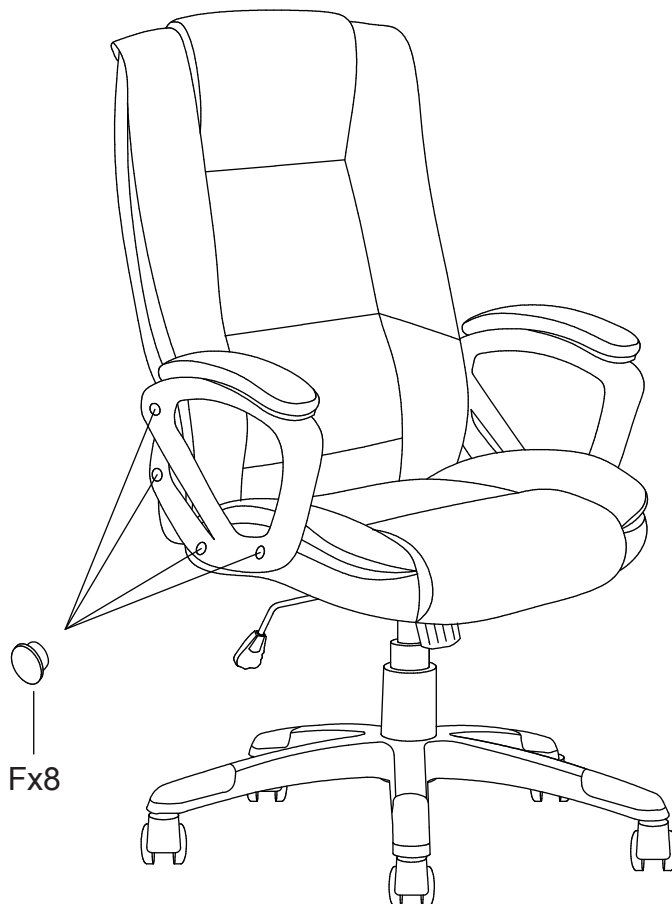

Fx8

Fx8

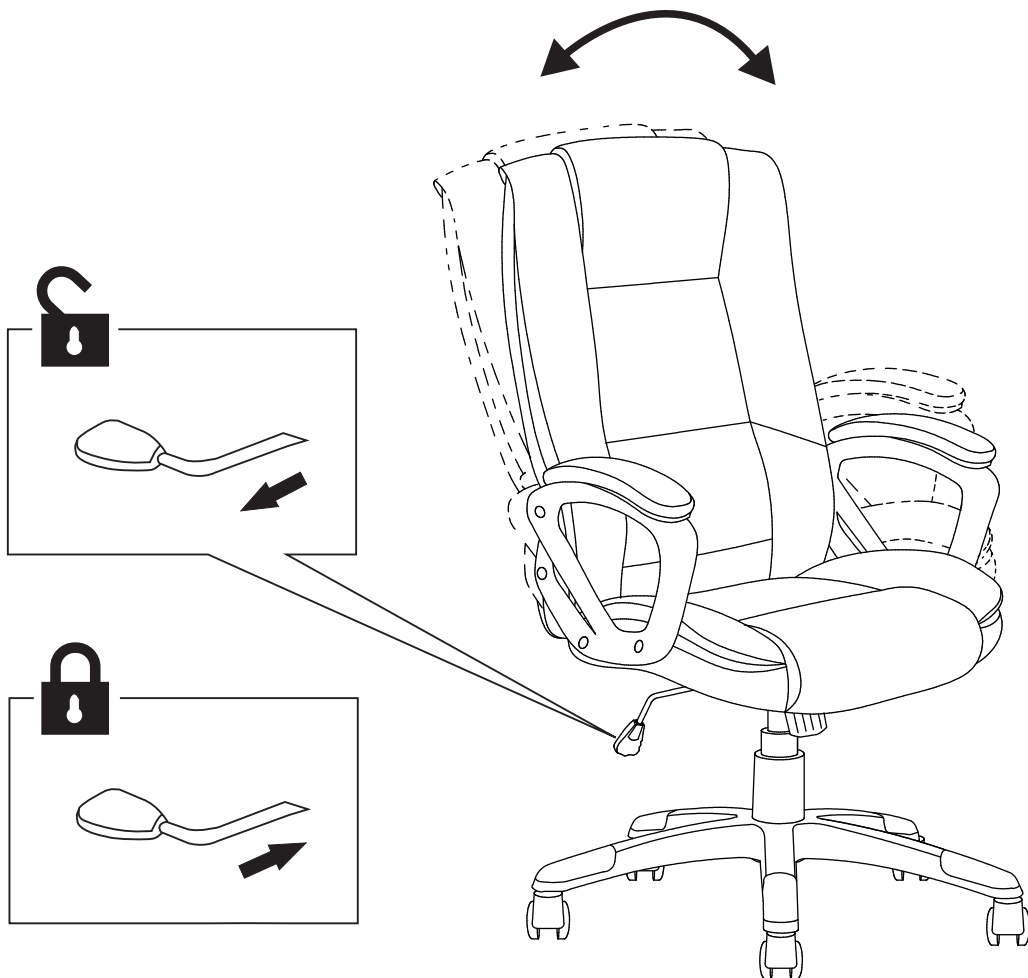
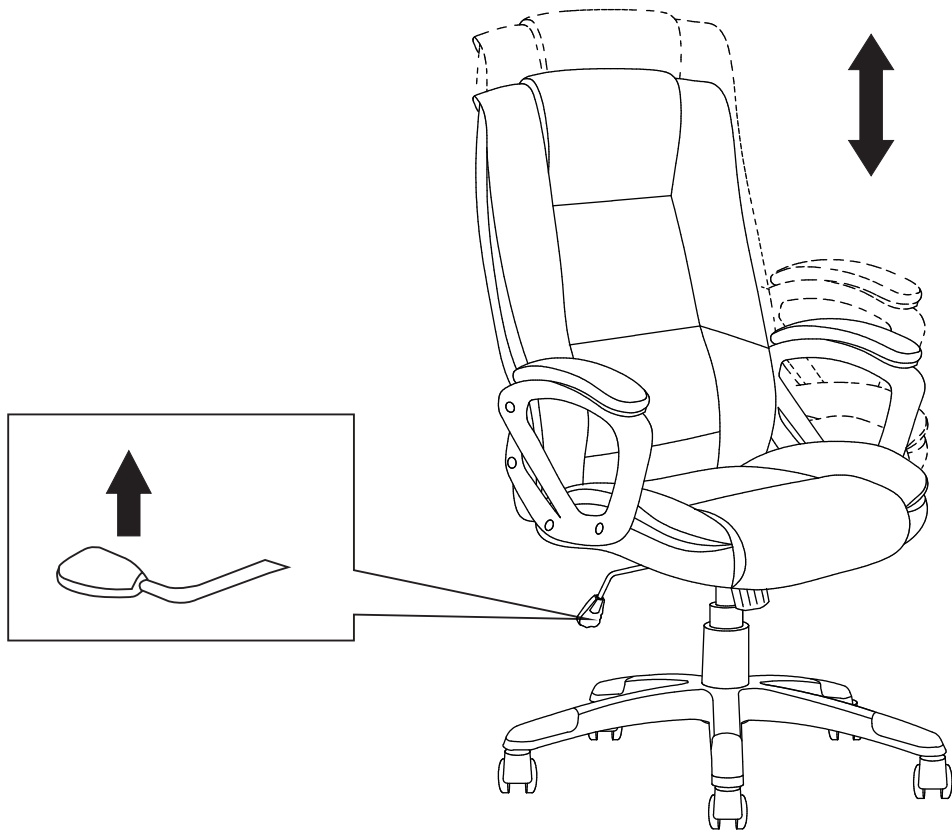

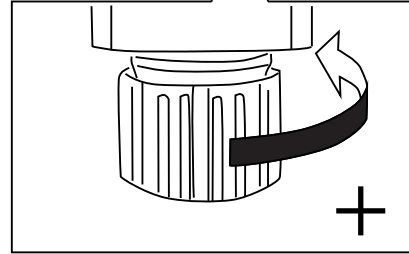
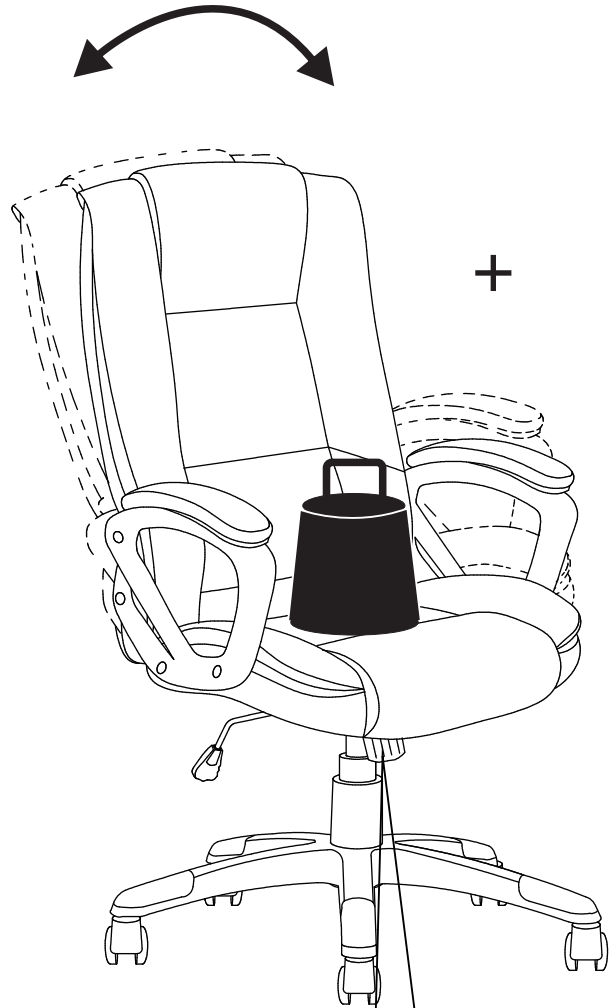
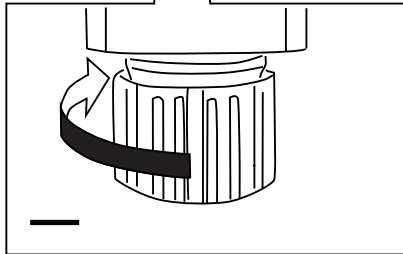
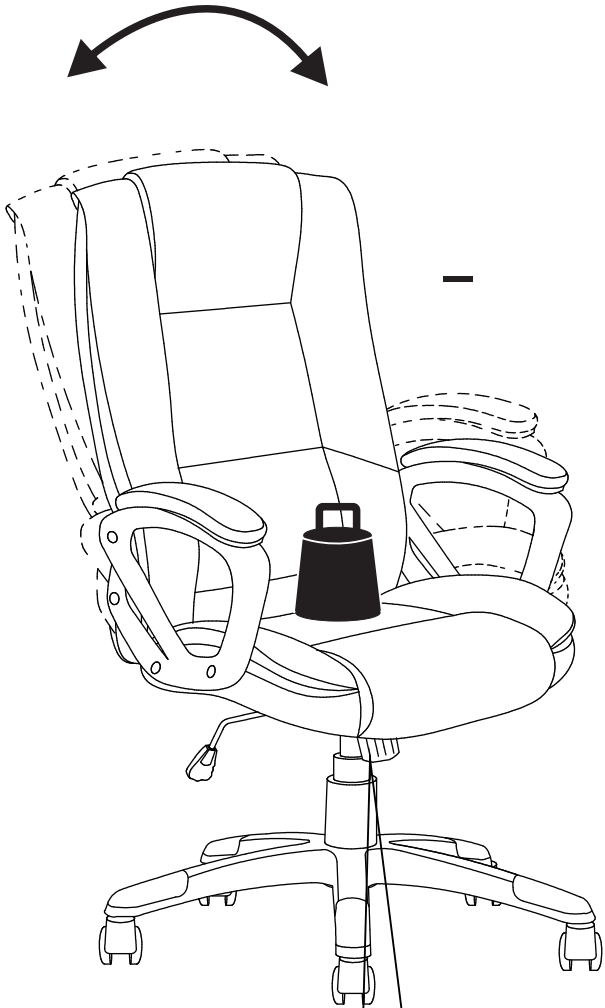

Pflegehinweise, Uказание за поддръжка, Pokyny k péči, Indicaciones de cuidado, Hooldusnóuanne, Consignes pour l'entretien, Ápolási útmutatás, Prležiúros nurodymas: Onderhoudsvorschriften, Conselhos de manutenção, Skótselrád, Norádjums par apkopi, Care instructions, Instrukcie ohradne starostlivosti, Wskazówka dotycząca czyszczenia, Istruzioni di manutenzione, Navodila za vzdrževanje, Napomene u održavanju, Indicații de întreținere, Советы по уходу, Napomena za održavanje, Bakım uyarısı

D - Allgemeln

Alle Oberflächen bitte nicht mit scharfen oder splzen Gegenständen beschädigen. Oberflächen bitte nicht mit scharfen Putz- oder Reinigungsmitteln behandeln. Zur Reinigung der Oberflächen verwenden Sie bitte lediglich ein angefeuchtetes Tuch. Dieses Produkt ist nur für den Einsatz im Privathaushalt konzipiert!

Massivholz

Feine Äste, Verwachsungen und kleine Risse sind naturbedingt und kein Reklamationsgrund. Farbdifferenzen zeugen von der Echtheit des Holzes und sind kein qualitativer Mangel.

Lackierte Oberflächen

Gegenstände bitte nicht ohne geeigneten Unterseizer auf den Oberflächen abstellen. Eventuell sichtbare Polier und Schleifspuren sind produktionsbedingt und stellen keinen qualitativen Mangel dar.

Glasoberflächen

Bitte keine heißen oder sehr kalten Gegenstände ohne geeignete Unterseizer auf die Glasfläche stellen.

Bitte die Glasfläche nicht als Arbeitsfläche zum Schneiden oder ähnliches benutzen.

Polster und Klissen

Nicht farbechte Bekleidung kann auf den hellen Bezugsstoffen abfärben. Ein Abfärben von Bekleidungstextilien kann nicht als Reklamationsgrund der Bezugsstoffe von uns anerkannt werden.

Metalloberflächen

Leicht sichtbare Spuren vom Schleifen unter der Beschichtung sind produktionsbedingt und kein qualitativer Mangel.

RU - Общее

Для любого вида поверхности - избегать повреждения острыми или колющими предметами.

Не обрабатывайте поверхности абразивными чистящими или моющими средствами. Для очистки поверхности используйте исключительно влажную салфетку. Этот продукт предусмотрен для применения только в домашних условиях!

Цельная древесина

Маленькие сучки, искривления и короткие трещины являются природными и не могут быть признаны поводом для рекламации.

Различие цвета свидетельствует о подлинности древесины и не является дефектом.

Лакированные поверхности

Не ставьте предметы на поверхность без соответствующей подставки.

Возможные видимые следы полирования и шлифования обусловлены процессом производства и не являются дефектами.

Стеклопные поверхности

Не ставьте горячие или слишком холодные предметы на стеклянную поверхность без подставки.

Не используйте стеклянную поверхность в качестве рабочей поверхности для резки или похожих действий.

Диваны и подушки

Линяющая одежда может окрашивать светлый обивочный материал.

Окрашивание от ткани одежды не может быть признано нами причиной претензии к обивочной ткани.

Металлические поверхности

Слегка видимые следы шлифования под покрытием обусловлены производством и не являются дефектом.

GB - General

Do not damage the surfaces with sharp or pointed objects.

Do not treat the surfaces with aggressive cleaning agents.

Only use a damp cloth to clean the surface.

This product is designed only for use within private homes!

Solid wood

Fine gnarls, knots and small cracks are natural occurrences and quite normal.

Differences in colour are evidence of the genuineness of the wood and do not represent a quality defect.

Painted surfaces

Do not stand objects on the surfaces without placing a coaster underneath.

Any visible signs of polishing and grinding marks are caused during manufacture and do not represent a quality defect.

Glass surfaces

Do not stand hot or very cold items on the glass surface without placing a coaster underneath.

Never use the glass surface as a surface for cutting or similar work.

Cushions and pillows

Non-colour-fast clothing can rub off on the bright upholstery fabrics.

We cannot accept the staining of upholstery fabrics by clothing fabrics rubbing off on them as a reason for complaint.

Metal surfaces

Slightly visible grinding marks under the coating are caused during manufacture and do not represent a quality defect.

NL - Algemeen

Scherpe of puntige materialen dienen te worden vermeden, aangezien deze de oppervlakken kunnen beschadigen.

Oppervlakken mogen niet worden behandeld met scherpe reinigingsmiddelen.

Om de oppervlakken te reinigen, kunt u een vochtige doek gebruiken.

Dit product is uitsluitend ontwikkeld voor particulier gebruik!

Massief hout

Fijne knoesten, vergroeiingen en kleine spleten zijn eigen aan het product en vormen geen reden tot reclamatie. Kleurverschillen getuigen van de echtheid van het hout en zijn geen kwaliteitsprobleem.

Gelakte oppervlakken

Gebruik altijd een geschikte onderzetter als u voorwerpen op het oppervlak plaatst.

Eventuele zichtbare polijst- en slijpsporen zijn eigen aan het productieproces en zijn geen kwaliteitsprobleem.

Glazen oppervlakken

Gefelieve geen hete of zeer koude voorwerpen op het glas te plaatsen zonder een geschikte onderzetter. Gefelieve het glazen oppervlak niet te gebruiken als werkblad voor snijden of soortgelijke activiteiten.

Zittingen en kussens

Niet-kleurechte kleding kan afgeven op lichte bekledingsstoffen.

Klachten op grond van het afgeven van kledingstukken op de bekleding kunnen niet door ons in behandeling worden genomen.

Metalen oppervlakken

Licht zichtbare slijpsporen onder de coating zijn eigen aan het productieproces en geen kwaliteitsprobleem.

F - Généralités

Veillez ne pas utiliser d'objets pointus ou tranchants pouvant endommager les surfaces.

Ne pas traiter les surfaces à l'aide d'un produit de nettoyage ou d'entretien.

Pour le nettoyage des surfaces, veuillez utiliser uniquement un chiffon humide.

Ce produit est conçu uniquement pour un usage privé!

Bois massif

De petits nœuds, légères difformités et fentes sont liés à la nature du bois et ne présentent pas un motif de réclamation.

Les différences de couleur témoignent de l'authenticité du bois et ne sont pas considérées comme un défaut de qualité.

Surfaces peintes

Ne pas poser d'objet sur les surfaces sans l'utilisation d'un dessous adapté.

Les éventuels polissages et éraflures visibles sont liés à la fabrication et ne présentent pas un défaut de qualité.

Surfaces en verre

Ne pas poser d'objets chauds ou très froids sur les surfaces en verre sans l'utilisation d'un dessous adapté.

Ne pas utiliser la surface vitrée comme plan de travail pour découper etc.

Rembourrages et coussins

Les vêtements qui ne sont pas grand teint peuvent décolorer les revêtements en tissu de couleur claire.

Toute décoloration des textiles d'habillement ne pourra pas être prise en compte par nous comme motif de réclamation au niveau des revêtements en tissu.

Surfaces en métal

Les légères traces de polissage visibles sous le revêtement sont liées à la fabrication et ne sont pas considérées comme un défaut de qualité.

TR - Genel

Yüzeylerin hiçbirine keskin veya sivri nesnelere zarar vermeyin.

Yüzeyleri keskin temizlik malzemeleriyle temizlemeyin.

Yüzeyleri, sadece nemli bir bezle temizleyin.

Bu ürün sadece evde kullanım için tasarlanmıştır!

Masif ahsap

İnce dallar, dolamalar ve ufak çatlaklar doğaldır ve şikayet nedeni değildir.

Renk farklılıkları ahşabın hakikiğini gösterir ve kalitesizliği göstermez.

Çilalı yüzeyler

Yüzeylere altlık kullanmadan nesne koymayın.

Olası gözle görülen çila ve zımpara izleri ürüne özeldir ve kalitesizliği göstermezler.

Cam yüzeyler

Cam yüzeye, altlık kullanmadan sıcak veya çok soğuk nesnelere koymayın.

Cam yüzeyi kesmek veya benzeri işler için çalışma yüzeyi olarak kullanmayın.

Döşeme ve yastıklar

Solmayan kumaştan yapılan kaplamalar açık renkli döşeme kumaşlarını boyayabilir.

Kaplama tekstillerinin boyaması, döşeme kumaşlarıyla ilgili olarak tarafımızdan şikayet nedeni olarak kabul edilmez.

Metal yüzeyler

Kaplamaların altında zımparalamadan kaynaklı hafif gözle görülebilir izler ürüne özeldir ve kalitesizliği göstermezler.

PL Informacje ogólne

Chronić wszystkie powierzchnie przed uszkodzeniem ostrymi lub spiczastymi przedmiotami.

Nie czyścić powierzchni szorstkimi środkami czyszczącymi.

Do czyszczenia powierzchni stosować jedynie nawilżoną ścierekę.

Ten produkt został skonstruowany wyłącznie do użytku prywatnego!

Drewno lite

Delikatne sęki, przerosty i drobne pęknięcia są cechą naturalną i nie stanowią podstawy do reklamacji.

Różnice w kolorach świadczą o prawdziwości drewna, a nie o gorszej jakości.

Powierzchnie lakierowane

Nie stawiać na powierzchniach żadnych przedmiotów bez podkładek.

Eventualnie widoczne ślady polerowania i szlifowania są uwarunkowane sposobem produkcji i nie świadczą o gorszej jakości.

Powierzchnie szklane

Nie stawiać na szklanych powierzchniach żadnych gorących lub bardzo zimnych przedmiotów bez odpowiednich podkładek.

Nie stosować powierzchni szklanej jako blatu roboczego do krojenia lub podobnych czynności.

Tapicerka i poduszki

Farbowana odzież może przebarwiać jasne materiały poszycia.

Przebarwienie przez materiały odzieżowe nie może być powodem do uznania przez nas reklamacji materiału poszycia.

Powierzchnie metalowe

Łatwo widoczne ślady szlifowania pod powłoką są uwarunkowane sposobem produkcji i nie świadczą o gorszej jakości.

RO - Generalităţi

Nu deterioraţi suprafeţele cu obiecte tăioase sau ascuţite.

Nu trataţi suprafeţele cu detergenţi sau alte substanţe de curăţare agresive.

Pentru curăţarea suprafeţelor folosiţi doar o cârpă umezită cu apă.

Acest produs este destinat exclusiv utilizării în mediul casnic!

Lemn masiv

Nodurile fine, protuberanţele şi crăpăturile de mici dimensiuni sunt caracteristice naturale şi nu constituie motive de reclamaţie.

Diferenţele cromatice atestă autenticitatea lemnului şi nu sunt considerate defecte calitative.

Suprafeţe lacuite

Nu aşezaţi pe aceste suprafeţe obiecte fără un suport de protecţie adecvat.

Eventualele urme vizibile de şlefuire sau lustruire sunt cauzate de procesul de producţie şi nu sunt considerate defecte calitative.

Suprafeţe din sticlă

Nu aşezaţi pe suprafaţa din sticlă obiecte foarte fierbinţi sau reci, fără un suport de protecţie adecvat. Nu folosiţi suprafaţa din sticlă ca suprafaţă de lucru pentru tăierea alimentelor sau pentru alte operaţiuni similare.

Mobilier tapitat şi perne

Culoarea nerezistentă la transfer a hainelor se poate impregna pe materialul de culoare deschisă al huselor. Transferul culorilor de pe obiectele de îmbrăcăminte nu este considerat motiv de reclamaţie.

Suprafeţe din metal

Urmele de şlefuire uşor vizibile sub stratul aplicat pe suprafaţa metalică sunt cauzate de procesul de producţie şi nu reprezintă

defecte calitative.

HU - Általános tudnivaló

Kérjük, ne használjon éles vagy hegyes tárgyakat, nehogy megrongálja a felületeket. Kérjük, ne kezelje a felületeket erős pucoló- vagy tisztítószerekkel. Kérjük, csupán megnevelésített kendőt használjon a felületek megtisztításához. Ez a termék lakótérben történő használatra készült!

Tömörfa

Az apró csomók, a kinövések és a finom repedések a természet keze munkájának a gyümölcsei, ezért nem képezhetik kifogás tárgyát.

A színbeli eltérések nem a gyengébb minőségre, hanem a fa eredeti voltára utalnak.

Lakkozott felületek

Kérjük, alkalmas alátét nélkül ne tegyen rá tárgyakat a felületekre.

A felületeken esetleg látható polirozási- és csiszolási nyomok a gyártás során keletkeztek, és nem a silány minőség voltának a jele.

Üveg felületek

Kérjük, alkalmas alátét nélkül ne tegyen forró, vagy nagyon hideg tárgyakat az üvegfelületekre.

Kérjük, ne használja az üveg felületet munkaasztalként, például vágásra, vagy hasonlóra.

Kárpit és párna

A nem színtartó bevonat elszínezheti a világos huzatanyagot.

Ha a textil bútorbevonatok elszíneztek a huzatanyagot, az ennek okán emelt kifogásoknak nem tudunk helyt adni.

Fém felületek

A rétegbevonat alatt felsejő csiszolási nyomok a gyártás során keletkeztek, és nem a silány minőség voltának a jele.

SRB - Opšte

Molimo Vas da kod svih površina pazite da ih ne oštete sa oštrim ili šiljatim predmetima.

Molimo Vas da površine ne obrađujete sa agresivnim sredstvima za čišćenje.

Za čišćenje površina molimo koristite samo navlaženu krpu.

Ovaj proizvod je predviđen samo za upotrebu u okviru privatnog domaćinstva!

Masivno drvo

Fine grane, zarusla mesta i sitne pukotine su prirodno prouzrokovane i ne predstavljaju razlog za reklamaciju.

Odstupanja boje su pokazatelj za pravo drvo i ne predstavljaju kvalitativan nedostatak.

Lakirane površine

Molimo Vas da ne postavljate predmete na površine bez podobnog podmetača.

Eventualno vidljivi tragovi poliranja i struganja su nastali u okviru postupka proizvodnje i ne predstavljaju kvalitativan nedostatak.

Staklene površine

Molimo Vas da ne postavljate vrlo vruće ili vrlo hladne predmete na staklenu površinu bez upotrebe odgovarajućeg podmetača.

Molimo Vas da staklenu površinu ne koristite kao radnu površinu za rezanje ili slično.

Sunder i jastuci

Veštački bojena odeća može puštati boju na svetlim tkaninama presvlake.

Puštanje boje tekstila odeće ne možemo da priznajemo kao razlog za reklamaciju tkanine presvlake.

Metalne površine

Blago vidljivi tragovi brušenja ispod površinskog sloja predstavljaju posledicu postupka proizvodnje i nisu kvalitativni nedostatak.

BG - Обща информация

Моля не повреждайте повърхностите с режещи или остри предмети.

Не обработвайте повърхностите със силни почистващи препарати.

За почистване на повърхностите използвайте единствено навлажнена кърпа. Този продукт е предназначен само за битова употреба!

Масивна дървесина

Малки чепове, грапавини и пукнатини са природно обусловени и не представляват основание за reclamaция.

Разлики в цвета свидетелстват, че дървесината е естествена, и не са дефект в качеството.

Лакирани повърхности

Моля не оставяйте върху повърхността предмети без подходящи подложки.

Евентуално забелязващи се следи от полиране и шлифование са производствено обусловени и не представляват дефект в качеството.

Състекли повърхности

Моля не оставяйте върху състеклената повърхност горещи или много студени предмети без подходящи подложки. Не използвайте състеклената повърхност като работна повърхност за рязане или други подобни.

Тапицерия и възглавници

Облекло с неустойчиви цветове може да оцвети светлите дамаски.

Причиненото от текстил на облекло оцветяване не се признава като причина за reclamaция за дамаските.

Метални повърхности

Слабо забележими следи от шлифование под покритието са производствено обусловени и не са дефект в качеството.

SLO Splošno

Površin ne poškodujte z ostrimi ali koničastimi predmeti.

Površin ne obdelujte z abrazivnimi čistili.

Za čiščenje površin uporabite samo vlažno krpo.

Ta izdelek je zasnovan samo za uporabo v gospodinjstvih.

Masivni les

Drobne grče, nepravilna rast in majhne razpoke so naravne ter jih ni mogoče uporabiti kot utemeljitev za reklamacijo.

Razlike v barvnih odtenkih izhajajo iz uporabe pravega lesa in ne predstavljajo pomanjkljive kakovosti.

Lakirane površine

Na površine ne odlagajte predmetov brez ustreznih podstavkov.

Morebitne vidne sledi poliranja in brušenja so proizvodno pogojene ter ne predstavljajo pomanjkljive kakovosti.

Steklene površine

Na stekleno površino ne postavljajte zelo vročih ali zelo hladnih predmetov brez primerne podstavka.

Steklene površine ne uporabljajte kot delovne podlage za rezanje ali kaj podobnega.

Blazine in odeje

Oblačila, ki nimajo trpežne barve, se lahko razbarvajo na svetlih prevlekeh.

Razbarvanje tekstila oblačil ne bo priznано kot vzrok za reklamacijo tkanin prevlek.

Kovinske površine

Rahle sledi brušenja pod premazom so proizvodno pogojene in ne predstavljajo pomanjkljive kakovosti.

P - Geral

Não danificar as superfícies com objetos afiados ou pontiagudos.

Não tratar as superfícies com detergentes agressivos.

Para a limpeza das superfícies, utilize apenas um pano húmido.

Este produto não foi concebido para uso doméstico!

Madeira macia

Pequenos nós, deformações e fissuras são naturais e não servem de base para reclamações. As diferenças de cor advêm da autenticidade da madeira e não representam qualquer falha qualitativa.

Superfícies pintadas

Não colocar objetos em cima das superfícies, sem uma base adequada.

Eventuais marcas visíveis de polimento e lixagem são resultado do processo de produção e não representam qualquer falha qualitativa.

Superfícies de vidro

Não colocar objetos muito quentes ou muito frios em cima das superfícies de vidro, sem uma base adequada.

Não utilizar as superfícies de vidro como área de trabalho para trabalhos de corte ou afins.

Almofadas e travesseiros

As peças de vestuário com cores que desbotam podem tingir os tecidos claros dos revestimentos.

Não aceitamos quaisquer reclamações com base no desbotamento de peças de vestuário e tingimento dos tecidos dos revestimentos.

Superfícies de metal

Eventuais marcas visíveis de lixagem por baixo do revestimento são resultado do processo de produção e não representam qualquer falha qualitativa.

HR - Općenito

Površine nemojte oštetiti oštrim ili šiljatim predmetima.

Površine nemojte tretirati agresivnim sredstvima za čišćenje.

Za čišćenje površine koristite samo vlažnu krpicu.

Uređaj je predviđen samo za korištenje u privatnim kućanstvima!

Masivno drvo

Fini čvorovi, priraslice i male pukotine prirodni su i ne mogu biti razlog za reklamaciju. Razlike u boji dokazu su da se radi o pravom drvu i nisu kvalitativni nedostatak.

Lakirane površine

Nemojte ništa postavljati izravno na površinu, koristite odgovarajuće podmetače.

Eventualni vidljivi znaci poliranja nastali su tijekom proizvodnje i ne predstavljaju kvalitativan nedostatak.

Staklene površine

Nemojte postavljati vruće ili hladne predmete izravno na površinu, koristite odgovarajuće podmetače.

Nemojte koristiti staklenu površinu kao radnu podlogu prilikom rezanja ili sličnih aktivnosti.

Jastuci i jastučici

Boja s odejce nepostojanih boja može preći i na svijetlo obojene tkanine na namještaju.

Tako obojena tkanina ne može se smatrati valjanim razlogom za reklamaciju oštećene tapacirane tkanine.

Metalne površine

Jedva vidljivi tragovi oegrebotina od blanjanja nastaju tijekom proizvodnog postupka i ne predstavljaju kvalitativni nedostatak.

ES - Generalidades

No dañar las superficies con objetos afilados o puntiagudos.

No tratar las superficies con agentes de limpieza agresivos.

Para limpiar las superficies utilizar únicamente un paño humedecido.

¡Este producto solo está concebido para ser utilizado en el hogar privado!

Madera maciza

Los nudos diminutos, los entrecrecimientos y las pequeñas grietas son naturales y no constituyen motivos de reclamación. Las diferencias cromáticas derivan de la autenticidad de la madera y no son defectos cualitativos.

Superfícies lacadas

No posar objetos sobre las superficies sin protecciones adecuadas.

Las posibles marcas de pulido y lijado visibles vienen condicionadas por la producción y no son defectos cualitativos.

Superfícies de cristal

No posar objetos calientes ni muy fríos sobre la superficie de cristal sin protecciones adecuadas. No utilizar la superficie de cristal como superficie de trabajo para cortar o tareas similares.

Acolchados y cojines

La ropa cuyos tintes no sean sólidos puede teñir los tejidos de colores claros de los tapizados. No podemos aceptar las manchas por desteñimiento de la ropa como motivo de reclamación de los tejidos de tapizado.

Superfícies de metal

Las ligeras marcas de lijado por debajo del recubrimiento vienen condicionadas por la producción y no suponen defectos cualitativos.

LT Bendroji informacija

Nepažeiskite paviršių aštriais arba smailiais daiktais.

Neapdorokite paviršių agresyviomis valymo priemonėmis.

Paviršiams valyti naudokite tik sudrekiną šluostę.

Šis gaminyš skirtas tik naudoti butyje!

Masvivioli mediena

Smulkios šakelės, sąaugos ir nedideli įtrūkimai yra natūralūs reiškinys bei nėra pagrindas pateikti reklamaciją.

Spalvų skirtumai rodo, kad mediena yra natūrali, ir tai nėra kokybės trūkumas.

Lakuoti paviršiai

Nestatykite daiktų ant paviršiaus be tinkamo padėkliuko.

Galimai matomos poliravimo ir šlifavimo žymės atsirado gamybos metu ir nėra kokybės trūkumas.

Stikliniai paviršiai

Nestatykite karštų arba šaltų daiktų ant stiklinio paviršiaus be tinkamo padėkliuko.

Nenaudokite stiklinio paviršiaus kaip darbinio paviršiaus pjovimo arba pan, darbams.

Apmušalai ir pagalvės

Blunkantys drabužiai gali nudažyti šviesius apvalkalus.

Nepriimame reklamacijų, jei užvalkalus nudažė drabužiai.

Metaliniai paviršiai

Šiek tiek matomos šlifavimo žymės po dangos atsirado gamybos metu ir nėra kokybės trūkumas.

CZ - Všeobecné pokyny

Žádné povrchy nepoškozujte ostrými nebo špičatými předměty.

Na povrchy nepoužívejte ostré čisticí prostředky.

Kčištění povrchů používejte pouze navlhčený hadřík.

Tento výrobek je koncipován pro použití vsoukromé domácnosti!

Masivní dřevo

Drobné suky, srůsty amalé trhliny jsou dány přírodním materiálem a nejsou důvodem kreklamaci.

Barevné odlišnosti svědčí opravěm přírodním dřevě a nejsou kvalitativním nedostatkem.

Lakované povrchy

Nestavějte na povrchy předměty bez vhodných podložek.

Případné viditelné stopy po leštění abroušení jsou dány výrobou a nepředstavují kvalitativní nedostatek.

Skleněné povrchy

Nestavte na skleněné plochy horké nebo velmi studené předměty bez vhodných podložek.

Nepoužívejte skleněnou plochu jako pracovní plochu ke krájení apodobně.

Polstrování apolštáře

Nestálobarevné oděvy mohou zabarvovat světlé potahové látky.

Zabarvení od textilního oblečení nemůžeme uznat jako důvod kreklamaci potahových látek.

Kovové povrchy

Snadno viditelné stopy od broušení pod povrchovou vrstvou jsou dány výrobou a nejsou kvalitativním nedostatkem.

EST Üldine informatsioon

Ärge kahjustage pindu teravate või teravaotsaliste esemetega.

Ärge töödelge pindu kangete küürimis- või puhastusvahenditega.

Palune kasutage pindade puhastamiseks ainult kergelt niisutatud lappi.

See toode on mõeldud ainult koduses majapidamises kasutamiseks!

Täispuut

Peened oksad, sõlmekohad ja praod on loodusliku materjali omadusest tingitud ja ei anna reklamatsiooni esitamiseks põhjust.

Erinevused värvuse osas annavad tunnistust puidu ehtsusest ning need ei kujuta endast kvaliteedi defekti.

Lakitud pinnad

Ärge asetage pindadele esemeid, mille all ei ole sobivat alust.

Kui pindadel on näha poleerimis- ja lihvimisjälgi, siis need on tootmisprotsessist tingitud ja ei kujuta endast kvaliteedi defekti.

Klaaspinnad

Palun ärge asetage klaaspinnale kuumi või väga külmi esemeid ilma sobiva aluseta.

Palun ärge kasutage klaaspinda tööpinna, kui teete lõiketõid või mingit muud sarnast tööd.

Polster ja padjad

Kate, mis ei ole värvikindel, võib heledatel mööbliriietel värvi anda.

Värviammist kattetekstilidele me ei pea mööbliriiete osas reklamatsiooni esitamise põhjust.

Metallpinnad

Kattekihil all nähtavad kerged lihvimisjäljed on tootmisprotsessist tingitud ja ei kujuta endast kvaliteedi defekti.

IT - Generali

Non danneggiare le superfici con oggetti appuntiti o affilati.

Non trattare le superfici con detersivi o prodotti per le pulizie aggressivi.

Per la pulizia delle superfici, utilizzare esclusivamente un panno umido.

Tale prodotto è stato concepito per l'uso in un ambiente privato!

Legno massiccio

Rametti, protuberanze e piccole fenditure sono naturali e non costituiscono un motivo di reclamo. Le variazioni cromatiche indicano l'autenticità del legno e non rappresentano un difetto di qualità.

Superfici laccate

Non appoggiare oggetti sulle superfici senza una protezione adeguata.

Eventuali tracce visibili di levigatura e rettifica sono legati alla produzione e non costituiscono un difetto qualitativo.

Superfici di vetro

Non appoggiare oggetti caldi o molto freddi sulle superfici in vetro senza una protezione adeguata.

Non utilizzare le superfici in vetro come superfici da lavoro per operazioni di taglio o attività simili.

Imbottitura e cuscini

Un rivestimento soggetto a scolorimento può perdere colore sui materiali di rivestimento chiari.

Uno scolorimento dei tessuti di rivestimento non può essere considerato un motivo di reclamo per i materiali di rivestimento utilizzati.

Superfici in metallo

Eventuali leggere tracce visibili di levigatura al di sotto del rivestimento sono legate al processo di produzione e non costituiscono un difetto qualitativo.

LV - Vispārīgi

Nebojāt visas virsmas ar asiem vai smailiem priekšmetiem.

Neapstrādāt virsmas ar abrazīviem tīrīšanas līdzekļiem.

Virsmu tīrīšanai izmantojiet tikai samitrinātu audumu.

Šis produkts paredzēts tikai lietošanai privātā mājāsaimniecībā!

Masīvā koksne

Sīki zari, saaugumi un mazas plaisas ir dabas parādības un nav pamats reklamācijām.

Krāsas atšķirības liecina par koksnes dabīgumu un nav kvalitātes trūkums.

Lakotas virsmas

Nelikt priekšmetus uz virsmām bez piemērota paliktņa.

Iespējami redzamas pulēšanas vai slīpēšanas pēdas ir ražošanas sekas un nav kvalitātes trūkums.

Stikla virsmas

Nelikt uz stikla virsmām ļoti aukstus vai karstus priekšmetus bez piemērota paliktņa.

Neizmantojot stikla virsmas kā darba virsmas šūšanai vai līdzīgam.

Polsterējums un spilvens

Izbalējošs apvalks var nokrāsoties uz gaišiem audumiem.

Apvalka tekstila izbālēšana nevar būt par apvalka audumu reklamācijas pamatu pie mums.

Metāla virsmas

Nedaudz redzamas pulēšanas vai slīpēšanas pēdas ir ražošanas sekas un nav kvalitātes trūkums.

S - Allmänt

Skada inte några ytor med skarpa eller spetsiga föremål.

Behandla inte ytor med starka puts- eller rengöringsmedel.

För rengöring av ytor, använd endast en fuktad duk.

Denna produkt är endast avsedd för användning i privata hushåll!

Massivt trä

Fina kvistar, utväxter och små sprickor är naturlaterade och utgör ingen reklamationsgrund.

Färgskillnader kommer från trämateriallets åkthet, och är inget kvalitetsfel.

Lackerade ytor

Ställ inte av föremål på ytor utan lämpligt underlägg.

Eventuella synliga polerings- eller slipspår är produktionsrelaterade och utgör inga kvalitetsfel.

Glasytor

Ställ inga varma eller kalla föremål utan lämpligt underlägg på glasytan.

Använd inte glasytor för arbetsyta för tillskärning eller liknande.

Madrasser och kuddar

Inte färgakta beklädnad kan färga av sig på ljusa överdragstygger.

En avfärgning på beklädnadstextilier godtas inte av oss som reklamationsgrund på överdragstyg

Metallytor

Lätt synliga spår från slipning under beläggningen är produktrelaterade och är inget kvalitetsfel.

SK - Všeobecné

Nepoškozujte žiadne povrchy ostrými alebo špičatými predmetmi.

Povrchy neošetrujte agresívnymi čistiacimi prostriedkami.

Na čistenie povrchu používajte iba vlhkú handričku.

Tento produkt je určený iba pre použitie v domácnosti!

Masívne drevo

Jemné uzly, zrasty a malé trhliny sú prirodzené a nie sú žiadnym dôvodom k reklamácii.

Farebné rozdiely sú dôkazom pravosti dreva a nie sú známkou žiadnej nízkej kvality.

Lakované povrchy

Na povrchy nekladte objekty bez príslušných podložiek.

Akékoľvek viditeľné známky leštenia a brúsenia sú spôsobené výrobou a nepredstavujú žiadnu chybu v kvalite.

Sklenené povrchy

Na sklenené povrchy nekladte žiadne horúce alebo veľmi studené predmety bez príslušných podložiek.

Nepoužívajte sklenený povrch ako pracovnú plochu na krájanie alebo podobné činnosti.

Podušky avankúše

Nestále farebné oblečenie môže pofarbiť svetlú potahovú látku.

Zafarbenie oblečením nemožno znašej strany považovať za dôvod k reklamácii potahových látok.

Kovové povrchy

Lahko viditeľné stopy po brúsení náteru sú spôsobené výrobou a nie sú kvalitativným nedostatkom.



- D** Achtung: Arbeiten an- und Austausch der Gasdruckfeder nur durch eingewiesenes Fachpersonal
- GB** Caution: work on and exchange of the gas spring shall be done only by trained personnel
- HU** Figyelem, munka a gázteleszkópon és annak cseréje csak betanított szakszemélyzet által végezhető
- S** OBS! Arbete vid och utbyte av gasfjädern endast genom utbildad personal
- NL** Waarschuwing, werk aan- en vervangen van de gasdrukveer alleen door deskundig vakpersoneel te verrichten.
- LT** Dėmesio, atlikti darbus su dujinėmis spyruoklėmis bei jas pakeisti gali tik kvalifikuoti darbuotojai.
- RO** Atenție: lucrările la și înlocuirea arcului pe gaz se va face doar de către personal instruit.
- RU** Внимание: Работы и смена газонаполненного амортизатора могут быть выполнены только проинструктированным,
- PL** Uwaga, prace przy podnośniku pneumatycznym lub jego wymiana mogą być przeprowadzane wyłącznie przez przeszkolony personel.
- SRB** Pažnja: radove na ugradnji i zamjeni plinske pritiske opruge izvoditi samo sa stručnim osobljem
- HR** Pozor: radnje na ugradnji i zamjeni plinske tlačne opruge smije se izvoditi samo preko stručnog osoblja
- LV** "Uzmanību! Darbu ar gāzes piespiedējatsperi un tāas nomaiņu drīkst veikt tikai instruēts, kvalificēts personāls."
- EST** Tähelepanu, gaasrõhuvedrude kallal tohib töötada ja neid vahetada ainult instrueeritud erialapersonal.
- SLK** Pozor, práce na plynovej vzpere a výmena plynovej vzpery iba prostredníctvom poučeného odborného personálu
- CZ** Pozor, práce na plynové pružině a její výměnu smí provádět pouze vyškolený odborný personál.
- BG** Внимание! Смяната на газовия амортизатор се извършва само от обучени специалисти.
- SLO** Pozor, kakršnakoli dela na plinskih vzmeteh in menjave lahko izvajajo samo izšolani strokovnjaki.
- IT** Attenzione: Lavori sulla molla a gas o la sua sostituzione solo da personale specializzato
- F** Attention : Travaux au ressort à gaz ou son échange seulement par personnel spécialisé
- ES** Cuidado: Trabajos en el amortiguador de gas o su cambio únicamente por personal especializado
- P** Atenção: Trabalhos na mola de pressão a gás ou sua substituição exclusivamente por pessoal Especializad
- TR** Dikkat: Gaz basıncı yayı değiştirilmesi ve üzerinde çalışmaları sadece bilgilendirilmiş uzman personel tarafından yapılabilir.

- D** nur für den privaten Gebrauch
- GB** Only for domestic use
- HU** csak magánhasználatra
- S** endast för privat bruk
- NL** uitsluitend voor privégebruik
- LT** tik asmeniniam naudojimui
- RO** doar pentru uz privat
- PL** wyłącznie do użytku prywatnego
- SRB** Samo za privatnu upotrebu
- HR** Samo za privatnu uporabu
- LV** tikai privātai lietošanai
- EST** ainult erakasutuseks
- SLK** iba na súkromné použitie
- CZ** pouze pro soukromé používání
- BG** само за лично ползване
- SLO** samo za zasebno uporabo
- IT** Solo per l'uso privato
- F** Seulement pour l'utilisation domestique
- ES** únicamente a uso personal
- P** Apenas para uso privado/incluídos na entrega
- TR** sadece özel kullanım için
- D** gebremste Rollen/ Teppichrollen
- GB** pressure casters/ carpet casters
- S** fékezett hengerek/ szőnyegtekercek
- NL** bromsade hjul/ hjul för mjuka golv
- LT** geremde wielen/ tapijtrullen
- RO** stabdantys ratukai/ kiliminei dangai skirti ratukai
- RU** role-roți cu frână/ Role pentru pardoseală moale
- PL** рулон коврового напольного покрытия
- SRB** kółka z hamulcem/ kółka twarde do nawierzchni miękkich (dywan)
- HR** Valjci na kočenju/ Rolne za tepihe
- LV** Kočni valjci/ Svitci za tepihe
- EST** nofiksētie ritenīši/ paklāju rullji
- SLK** pidurdatud rullid/ Vaibarattadx
- CZ** brzděné kolieska/ Kolieska na měkké podlahy
- BG** brzděná kolečka/ Kolečka na koberce
- SLO** колелца със спирачки/ Колелца за килими
- IT** kolesa z zavorami/ Kolesa za preproge
- F** Rulli frenati/ Rotoli di tappeto
- ES** Roulettes freinées/ Rouleaux de moquette
- P** Ruedas frenadas/ Rollos de tapiz
- TR** Rodas travadas/ Rolos de carpete
- TR** frenli makaralar/ Hali Taban Rulosu

