

980728

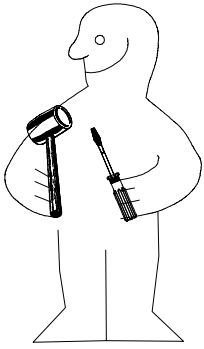

1.

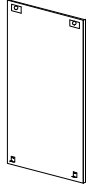

2.

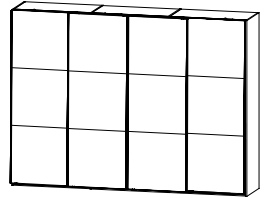
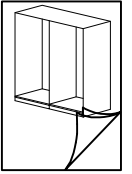
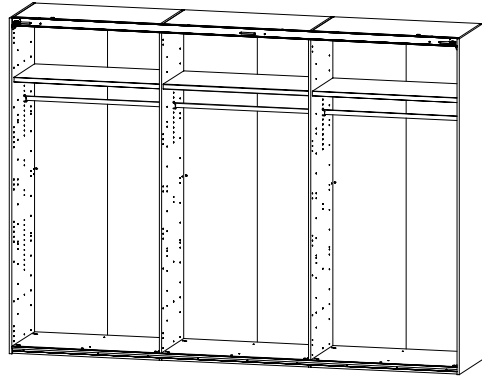
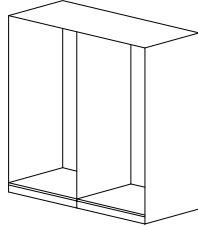

HSP 300 4trg NG

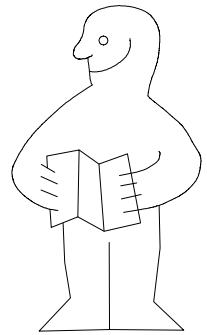
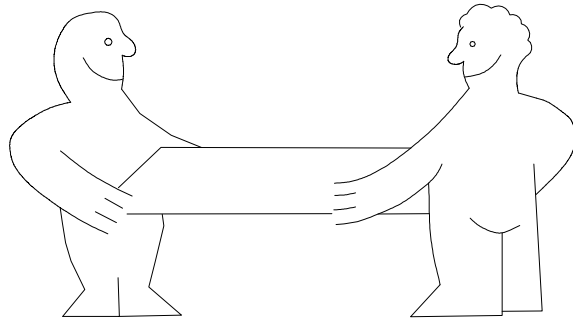
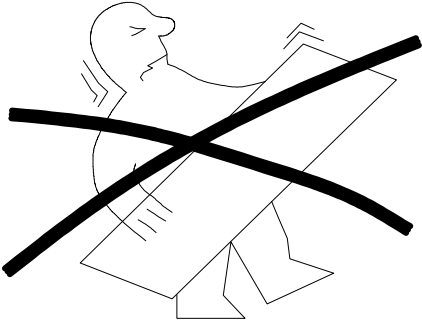

1-2-3-4... ○

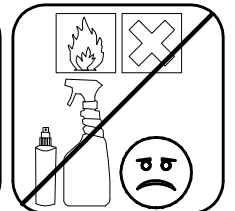
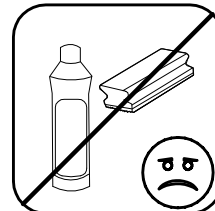
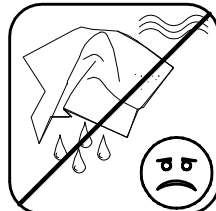
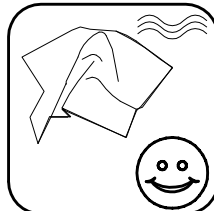
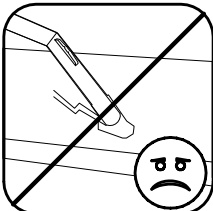
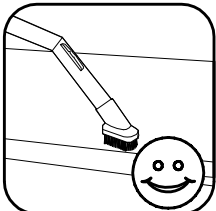
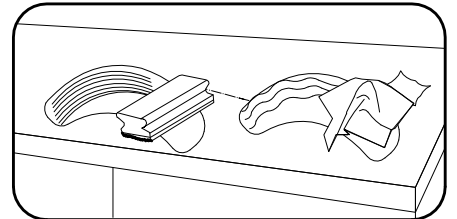
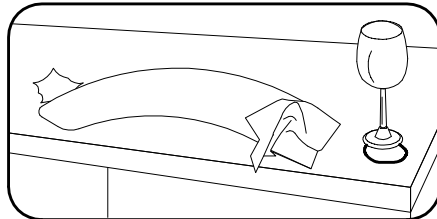
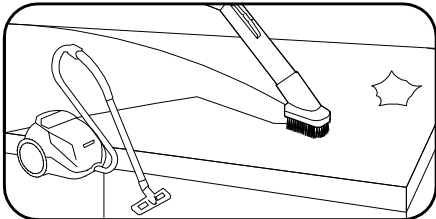
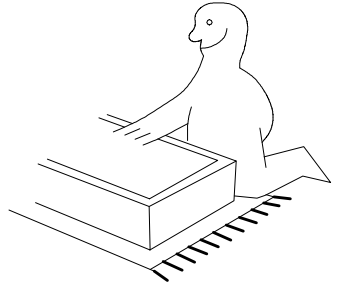
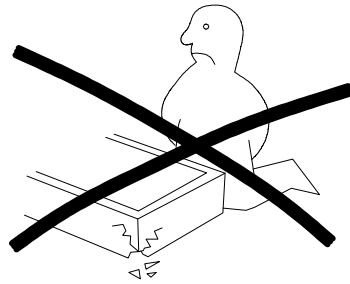
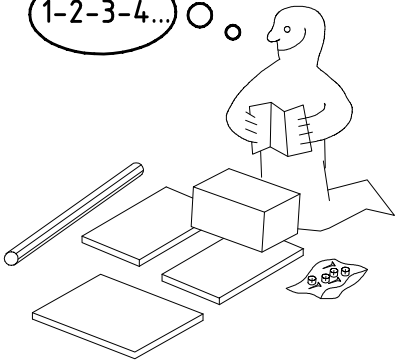





980728

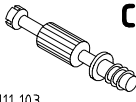

20.12.16 / -



12 16

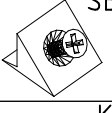

1/11

 111 xxx	A1	24x
 111 103	C	8x
	F3	8x

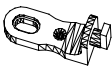
 111 xxx	S0	15x
 111 xxx ø12	V12	15x
 121 370 3,5 x 15 mm	G1	42x

 117 002	K2	6x
	SBV	24x
 100cm 121 400	K10	3x

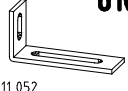

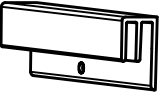

 111 611	J2	9x
 112 055 6,3 x 10,5 mm	T1	36x
 111 607	L8	12x

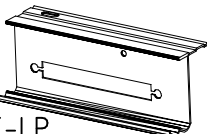

 111 052	o10	1x
 121 120 4 x 15mm	SP15	4x

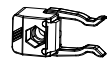
1x 
FPK
14.53/19.40/24.30/29.20/34.08

1x 
SWT-LP
14.53/19.40/24.30/29.20SY
/34.10 SY

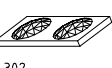

 121 xxx	SWT-ST	2x
 121 xxx M4 x 13 mm	SWT-SM5 GH13	2x
 121 xxx M4 x 10 mm	G43	6x
 121 xxx 3,5 x 35 mm	G14	6x
 121 375	G14	2x

 121 004	SWH-SKL	1x
 121 004 3,5 x 22 mm	SWH-SKR G24	1x
 352 302	KP8	10x
	KP8	4x

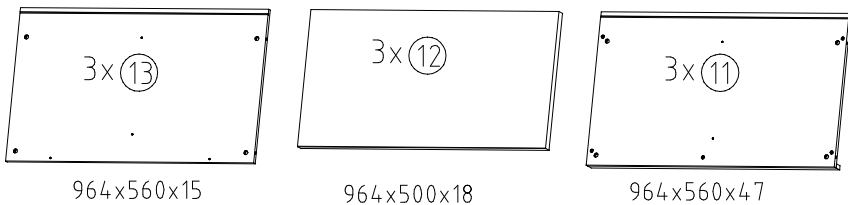
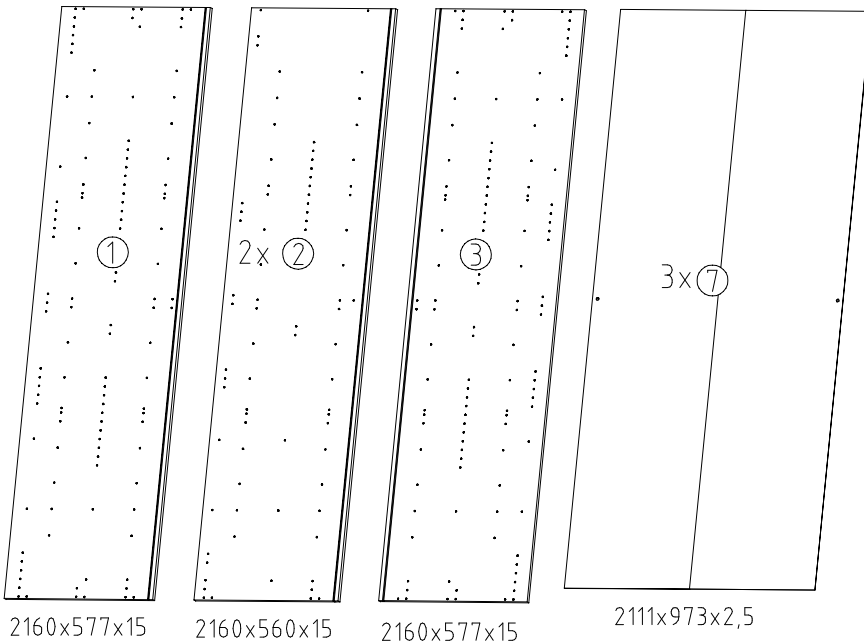
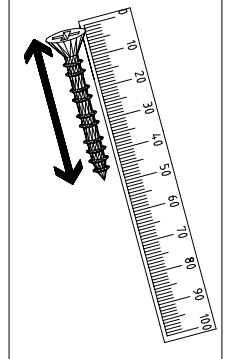
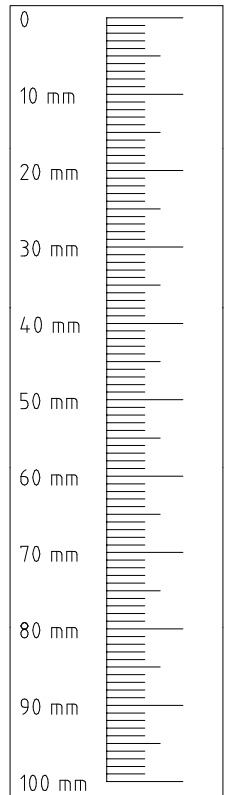
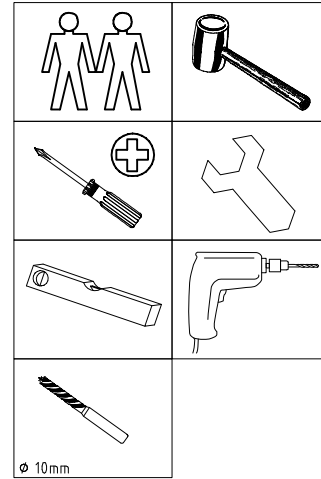

1

3,5 x 15 mm

G1

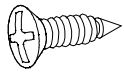

121 370

S0

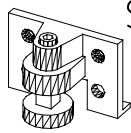

111 xxx

A1



111 xxx

3

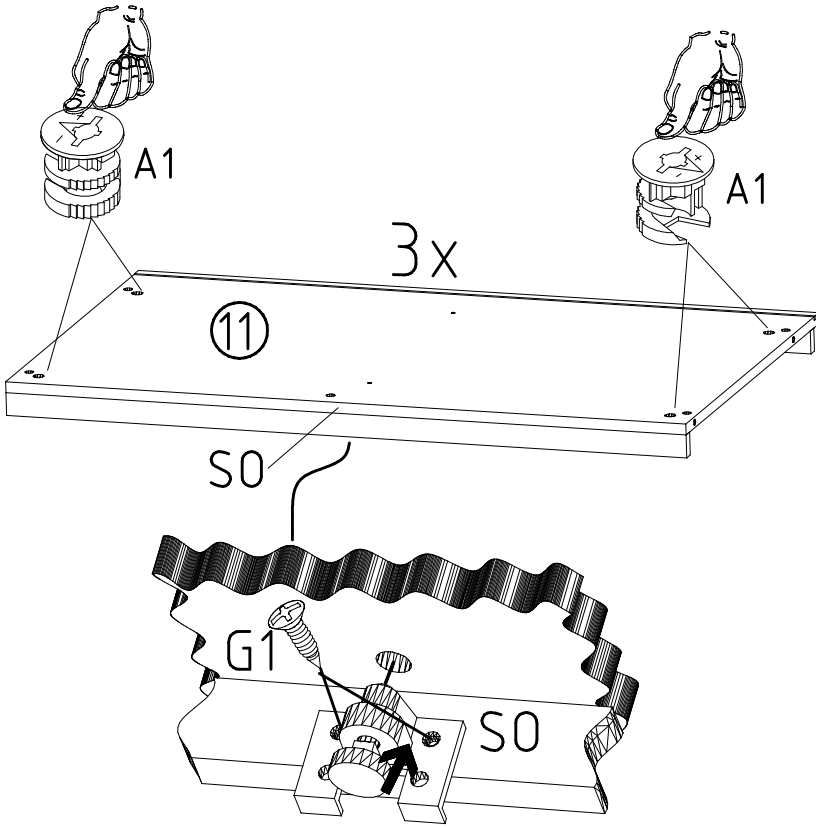

2

A1

111 xxx

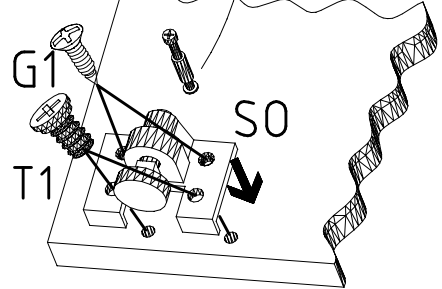
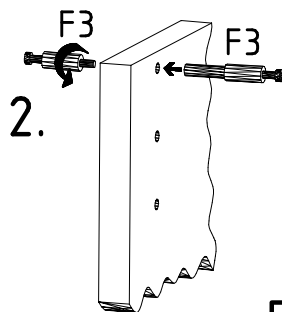
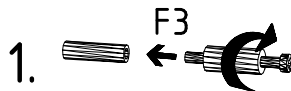
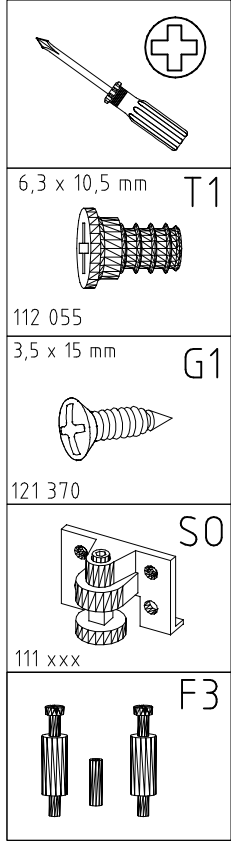
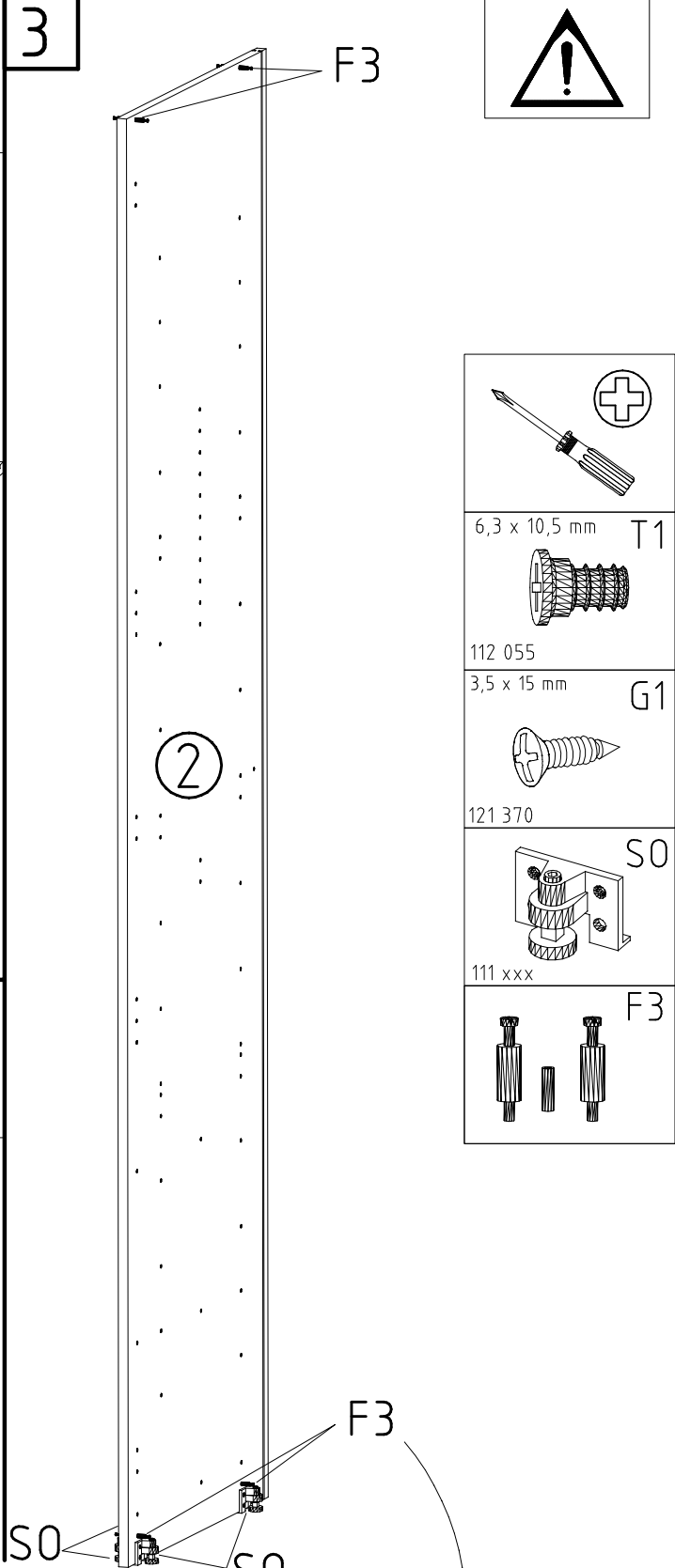
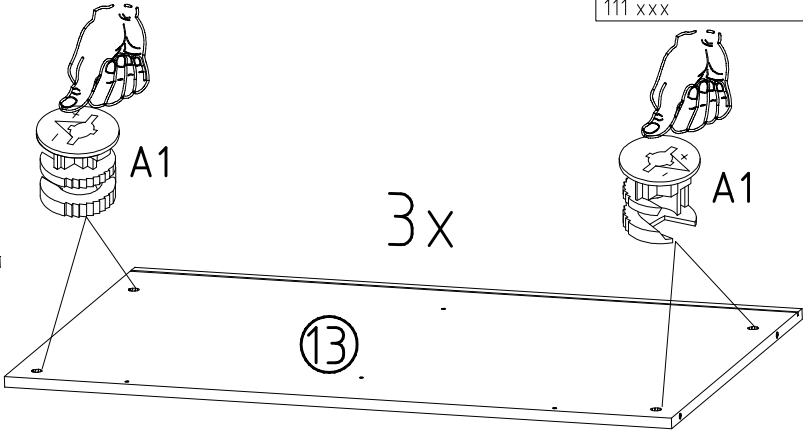

4

SWH-SKL

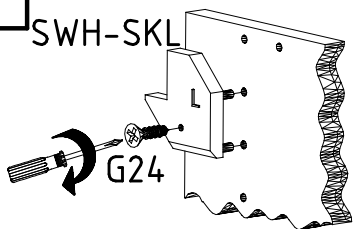

SWH-SKR

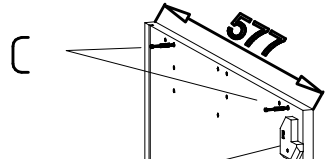
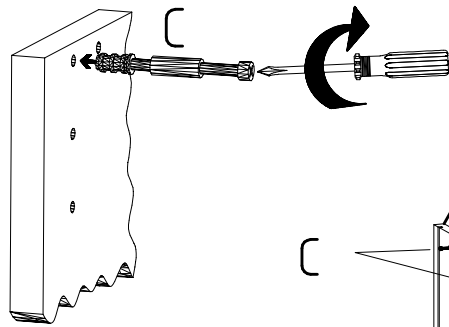
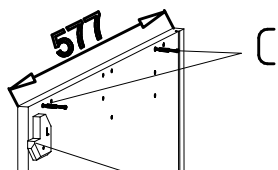
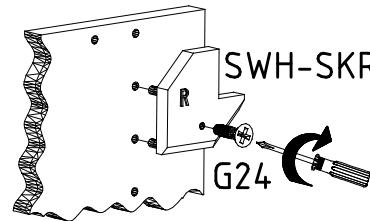

SWH-SKL + G24

SWH-SKR + G24

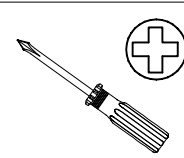

SWH-SKL

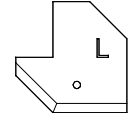

SWH-SKR

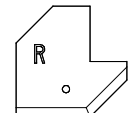

3,5 x 22 mm G24

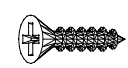

121 004

6,3 x 10,5 mm T1

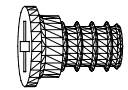

112 055

3,5 x 15 mm G1

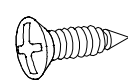

121 370

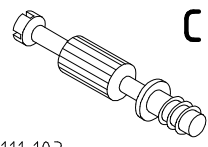

111 103

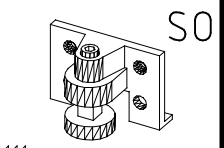

111 xxx

1

3

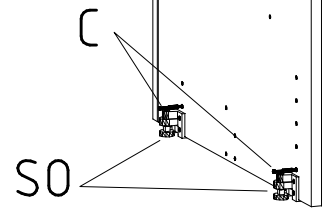
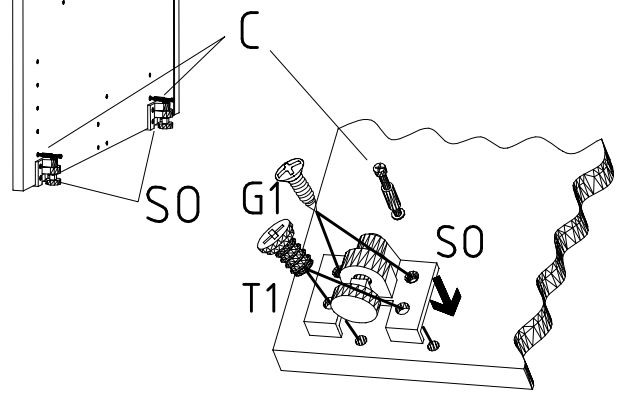

980728

20.12.16 / -

12 16

4 / 11

5

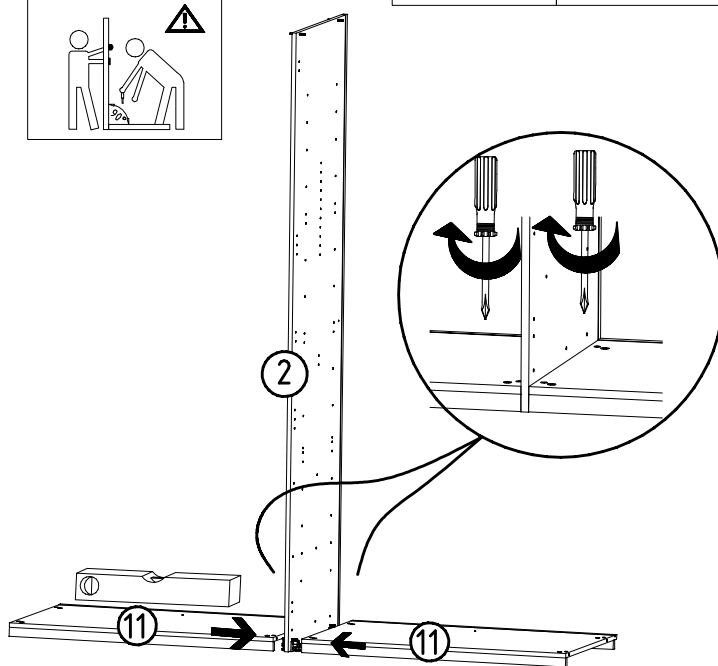
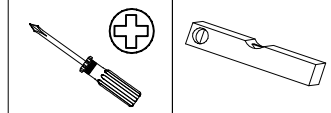

6

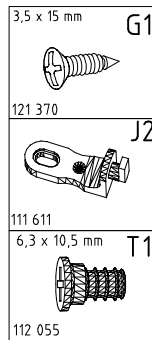
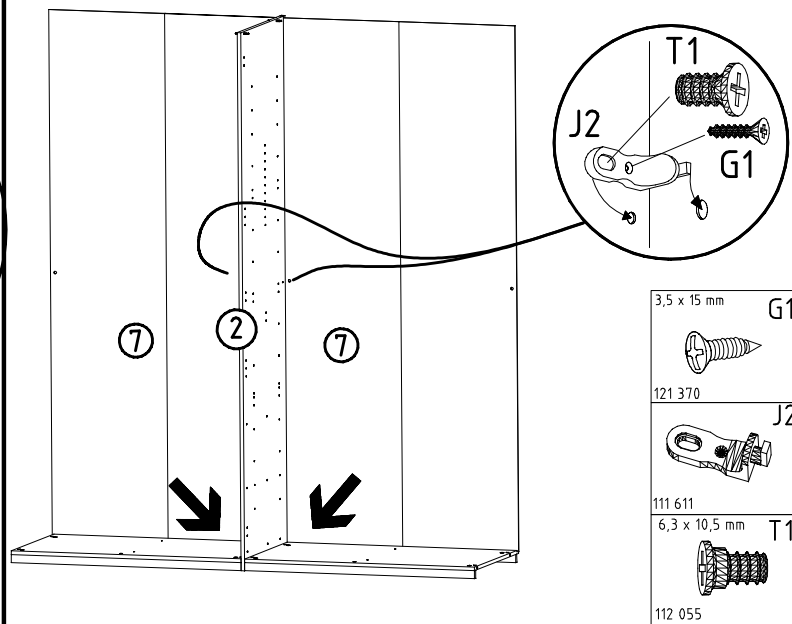
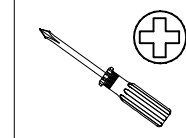

7

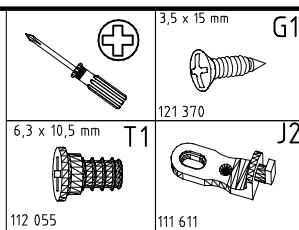

8

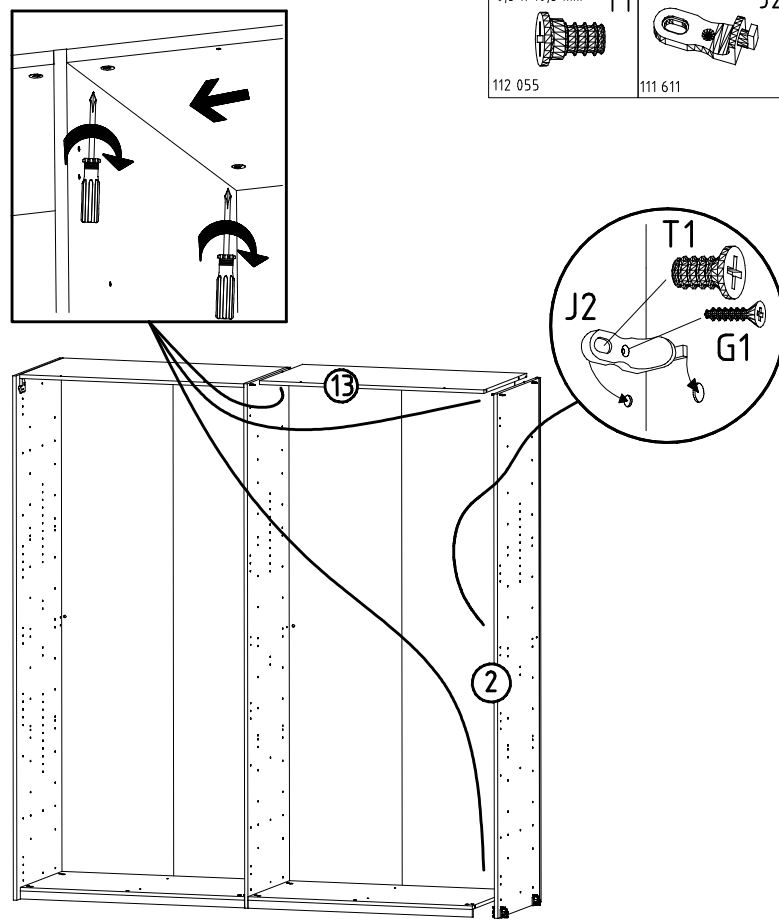
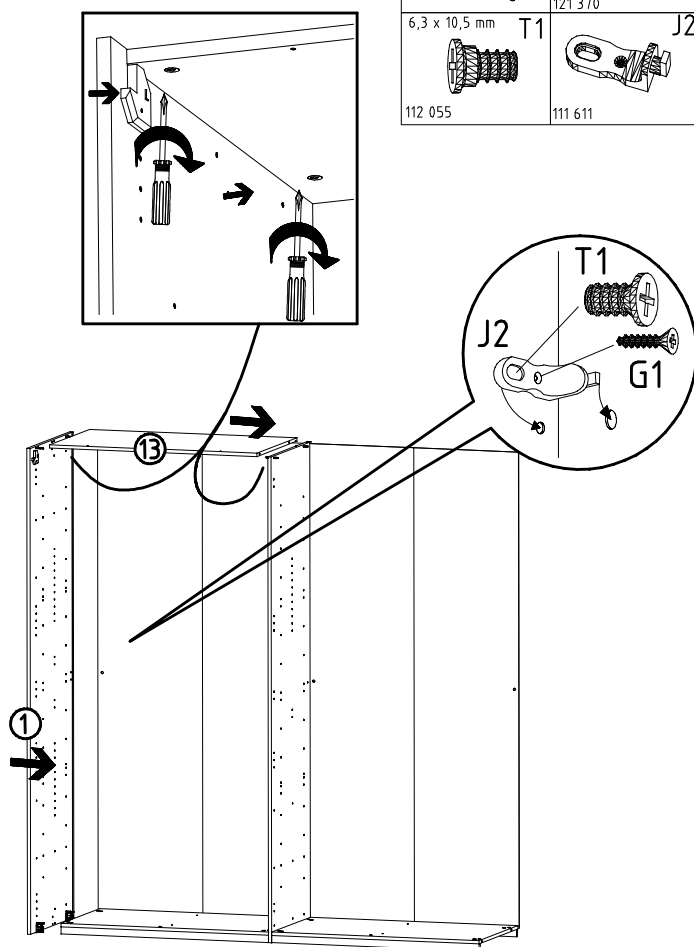
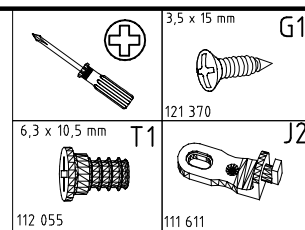

9

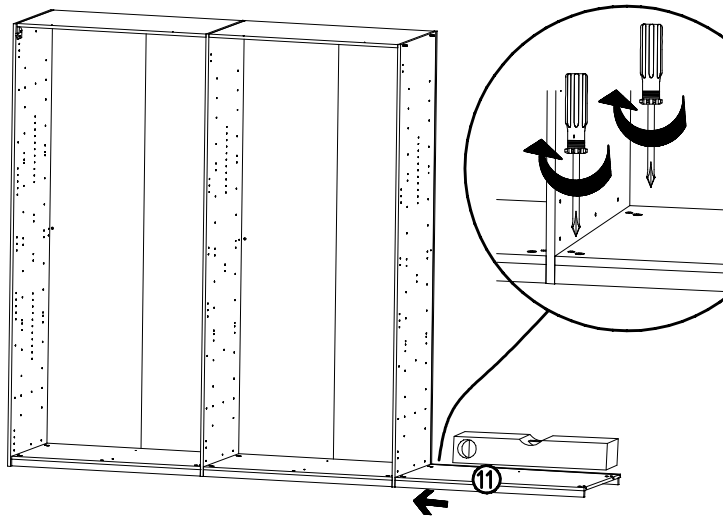
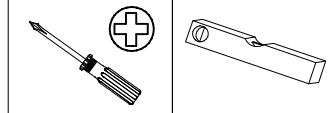
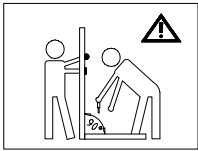

10

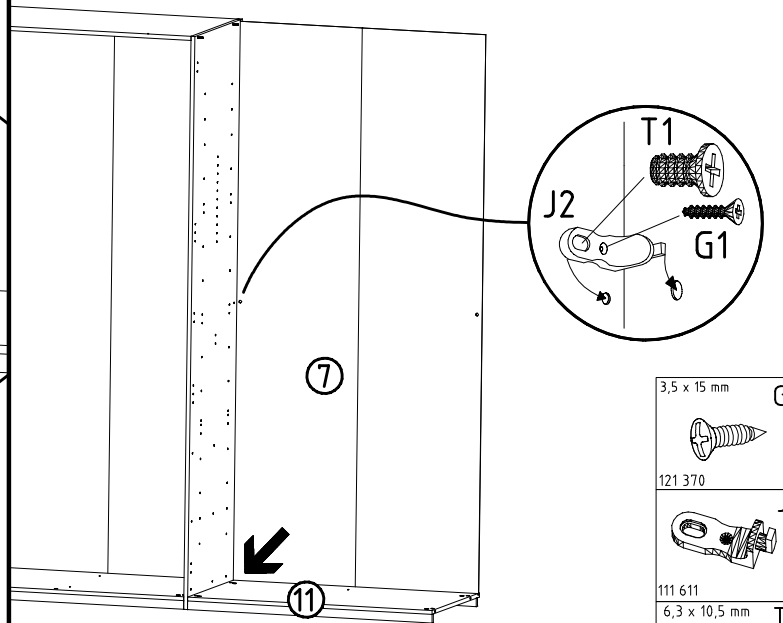
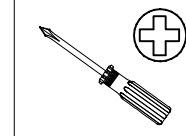

- 3,5 x 15 mm G1
- 121 370
- 111 611
- 6,3 x 10,5 mm T1
- 112 055

11

- 3,5 x 15 mm G1
- 121 370
- 111 611
- 6,3 x 10,5 mm T1
- 112 055

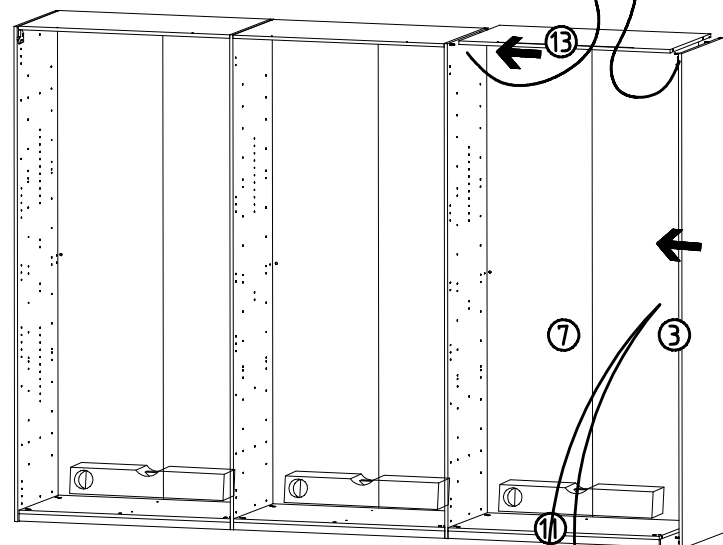
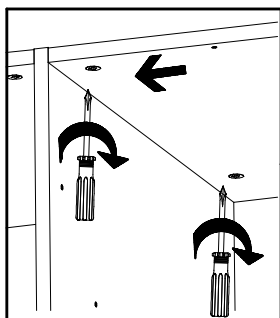

12

- L8
- 111 607
- K2
- 117 002
- 3,5 x 15 mm G1
- 121 370
- 100cm
- 112 400

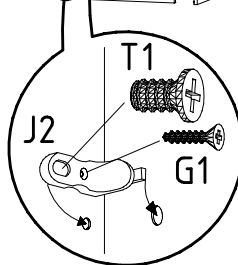
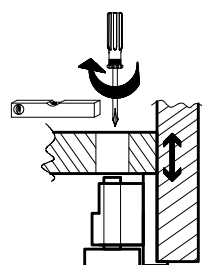
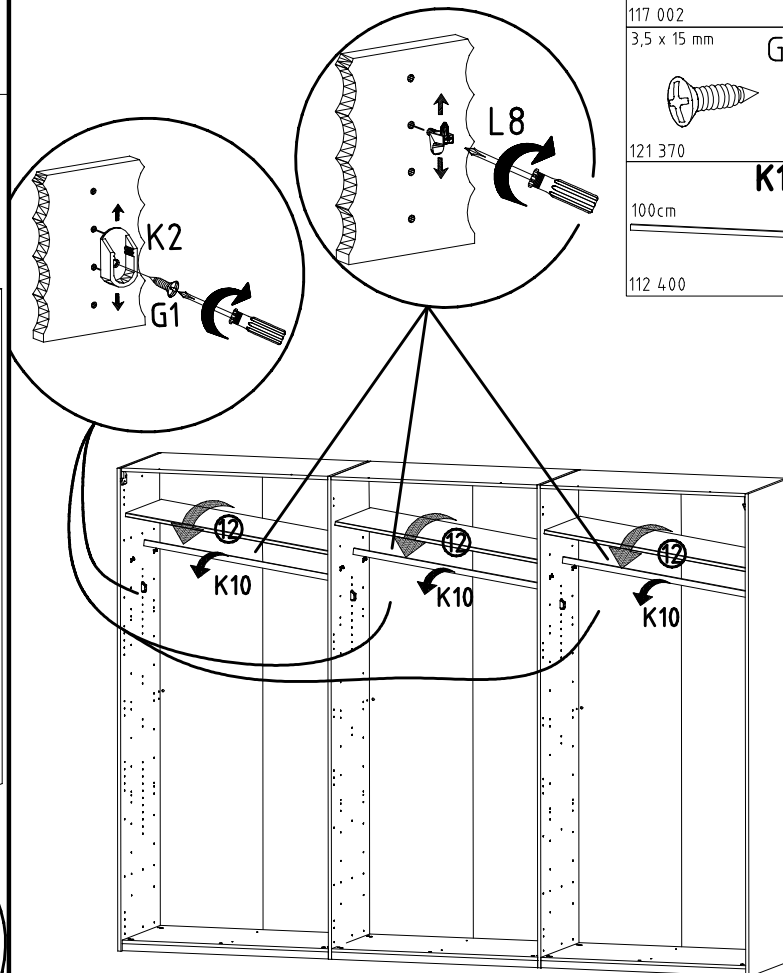

980728

20.12.16 / -

12 16

6/11

13

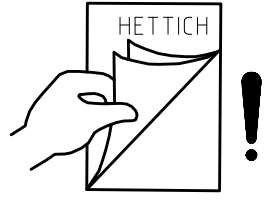
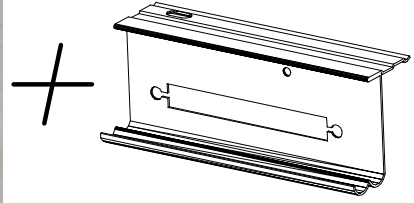
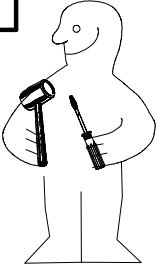

14

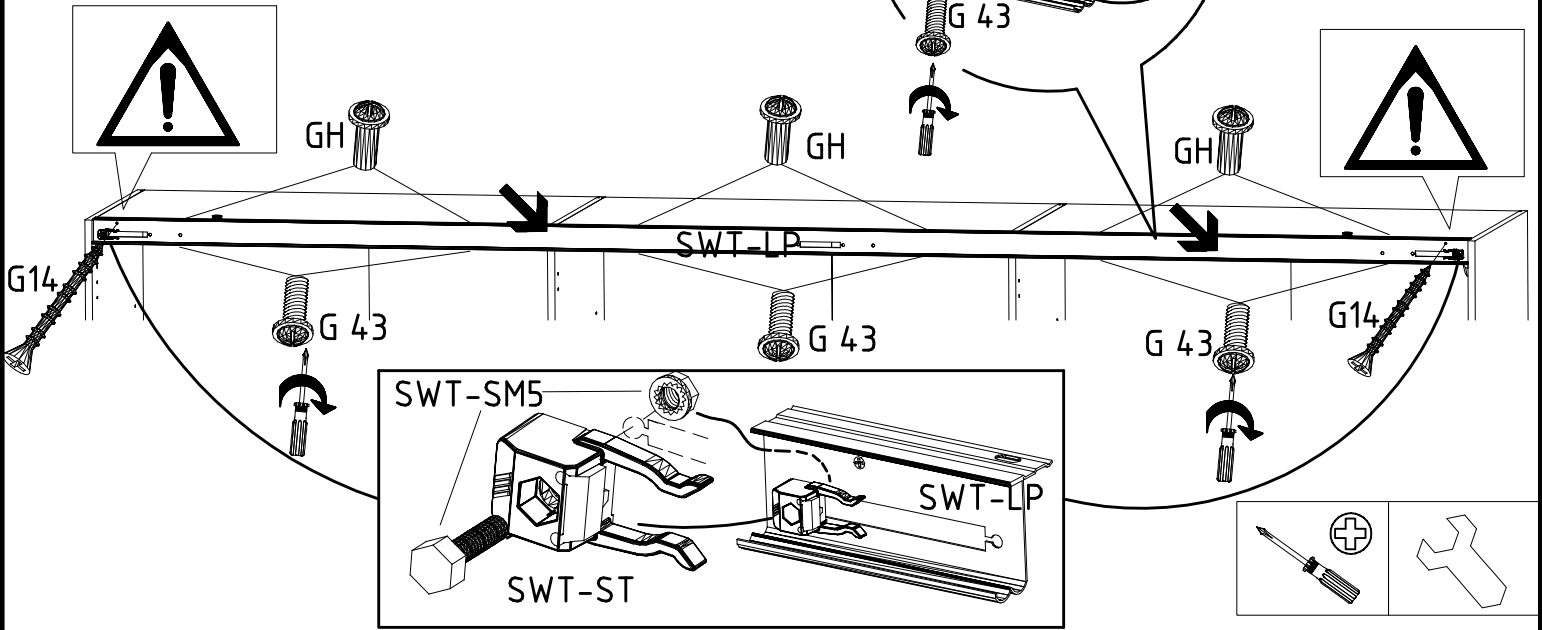
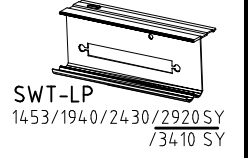
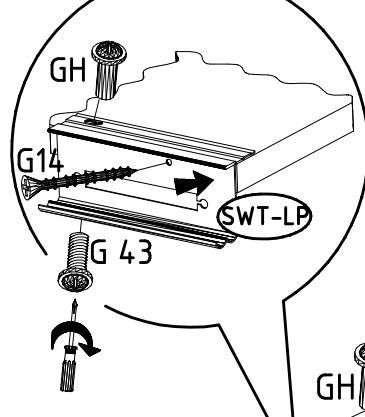
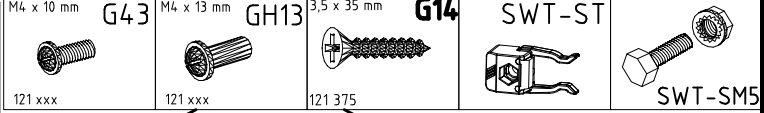
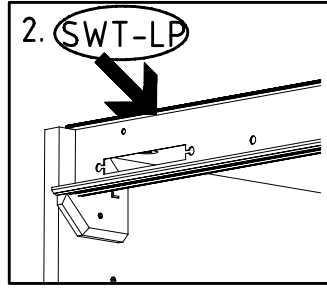
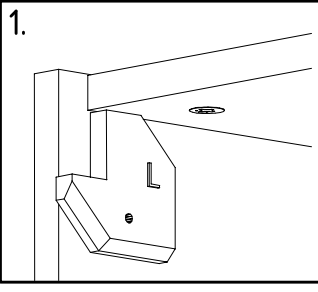

15

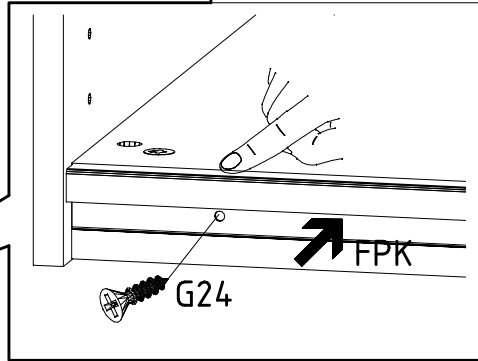
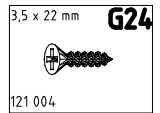
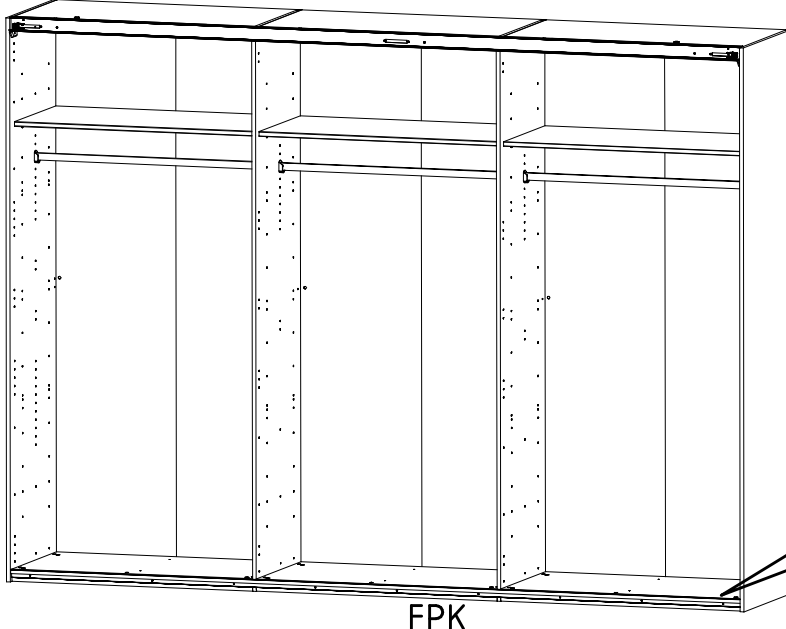

16

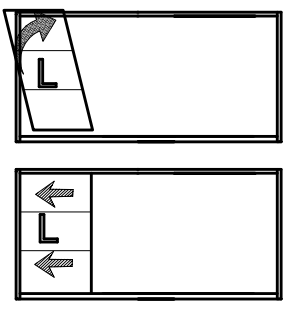

17

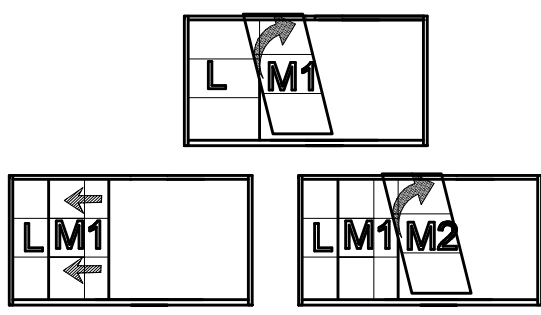

18

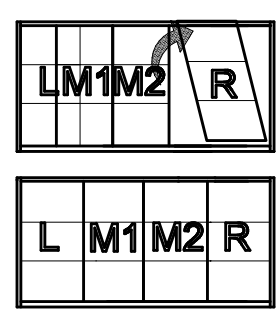

16 + 18

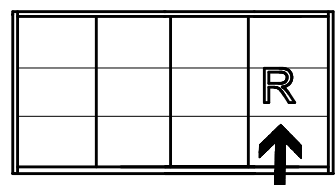
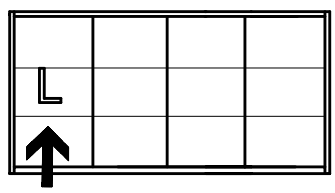

17

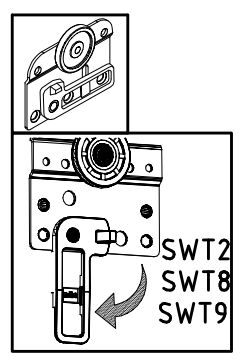
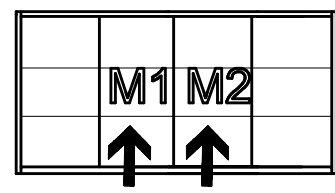

I.

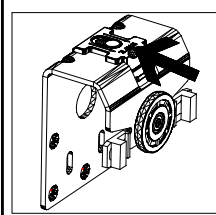
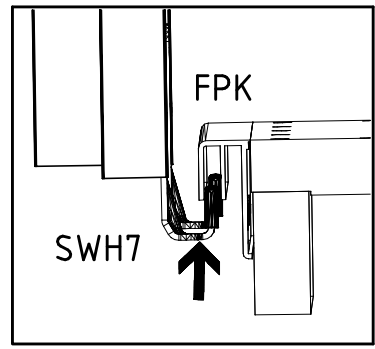

I.

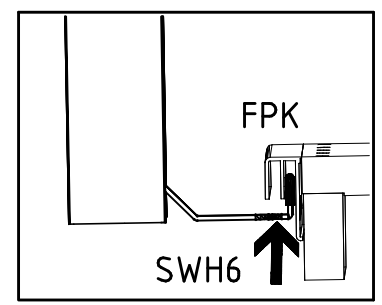

II.

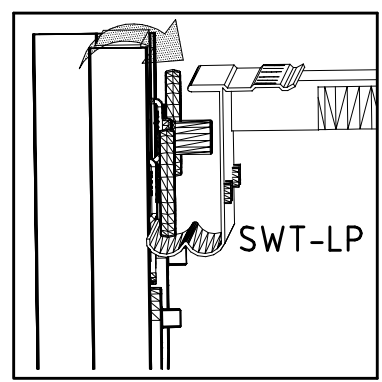

II.

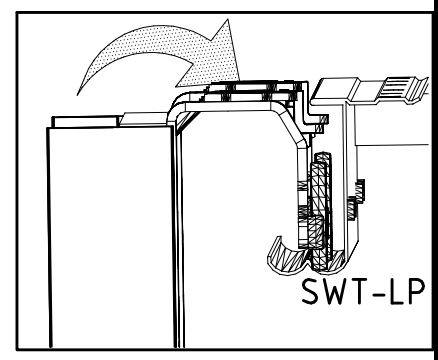

III.

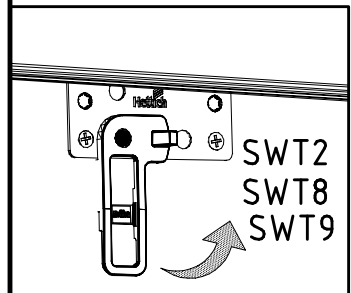

III.

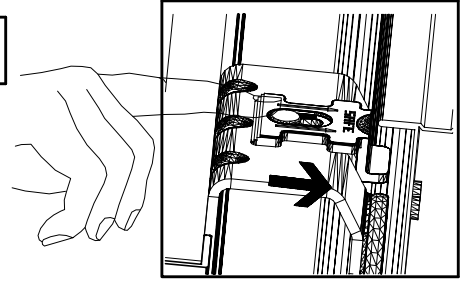
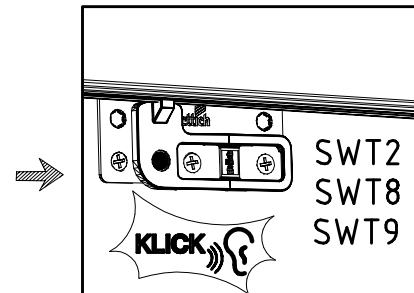

19

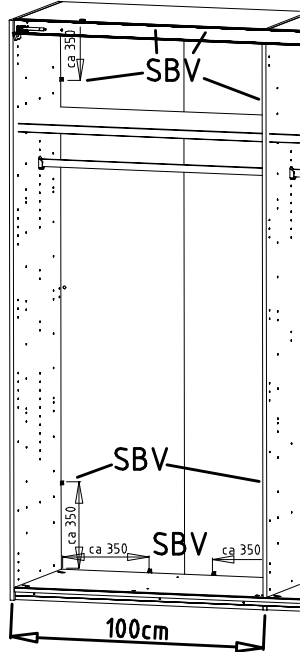
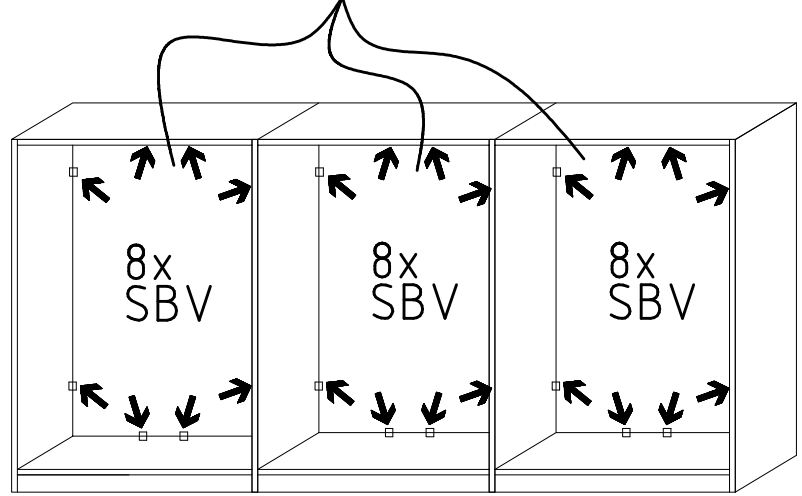
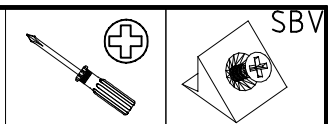
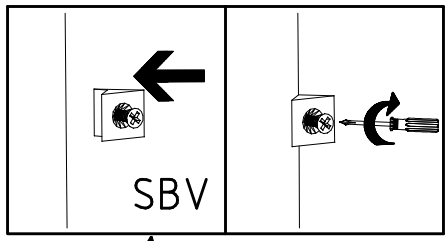

20

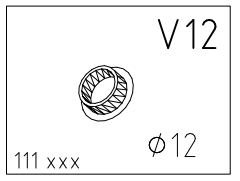
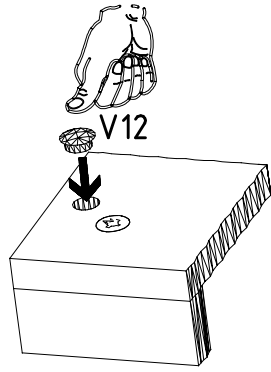
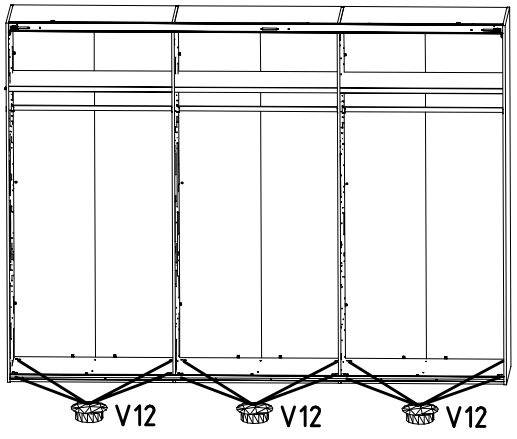

21

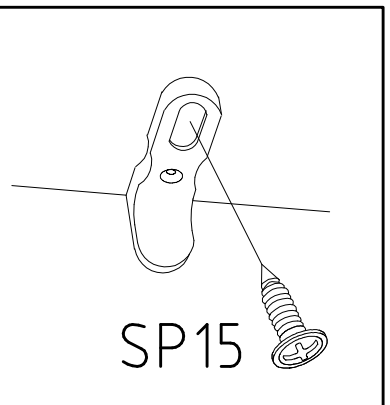
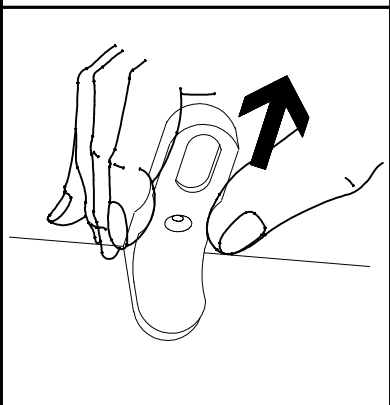
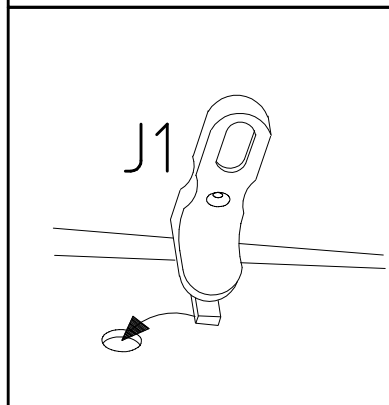
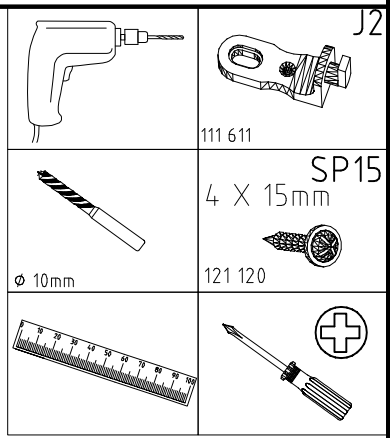
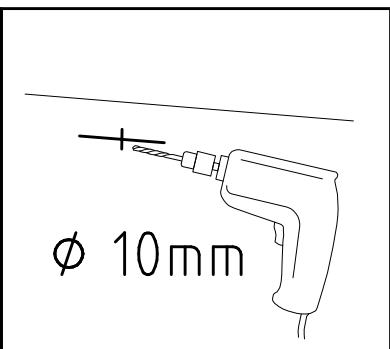
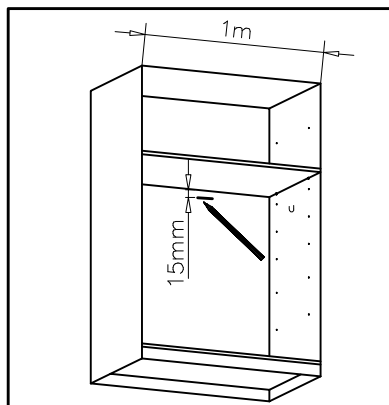

22

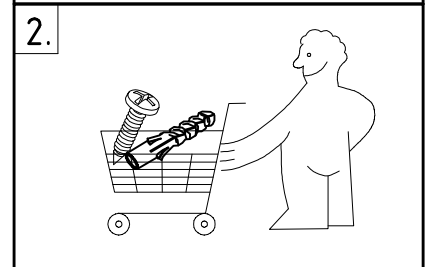
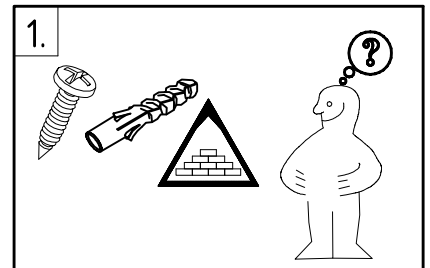
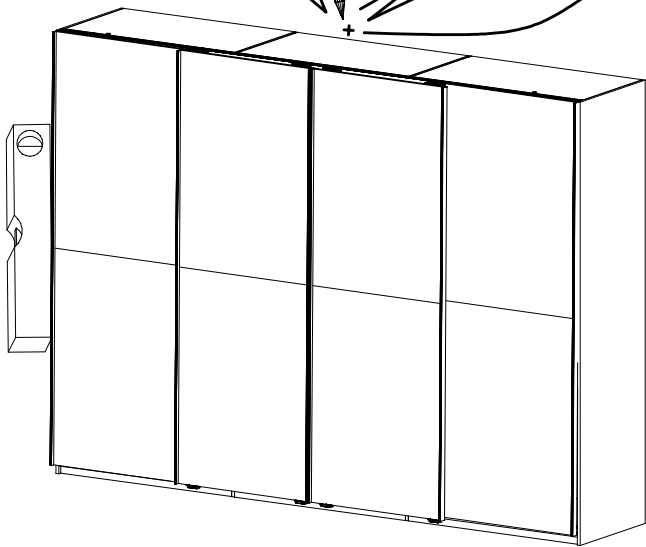
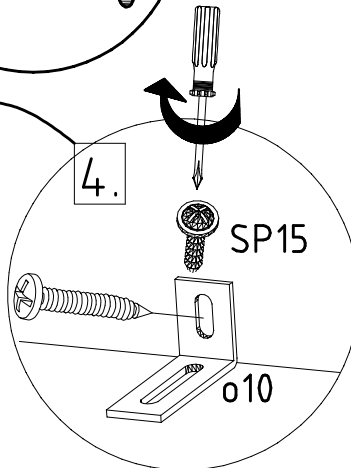
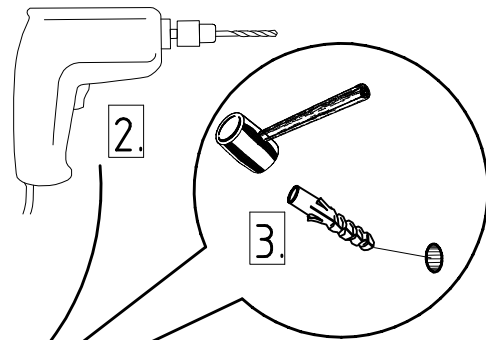
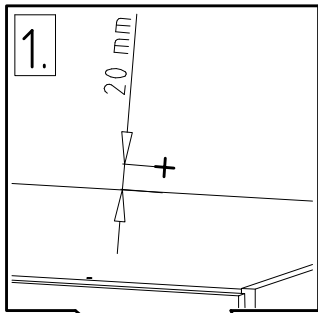
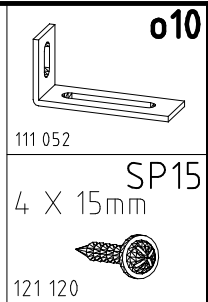
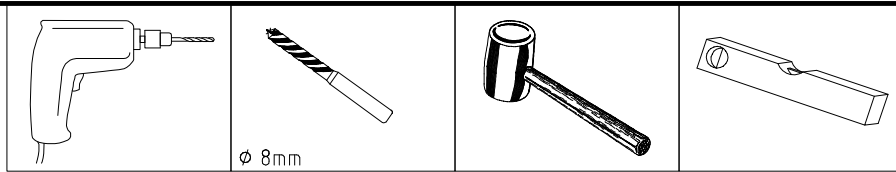

23

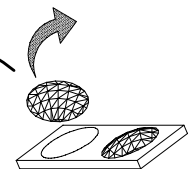
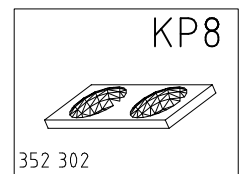
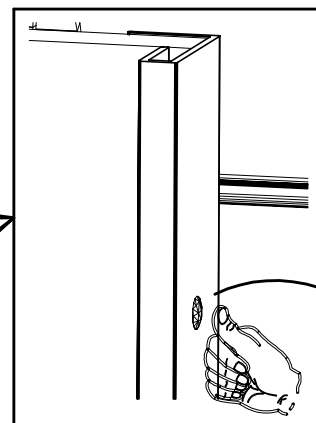
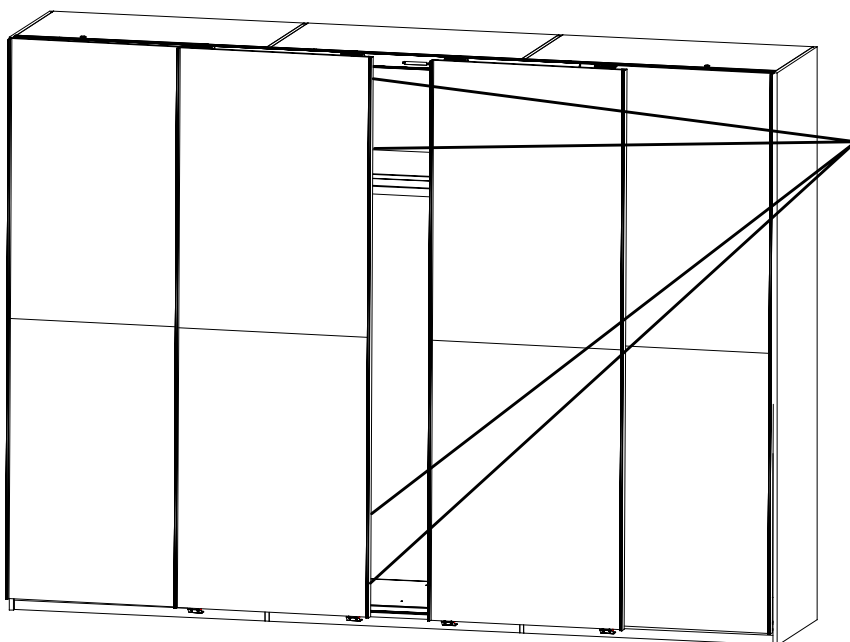

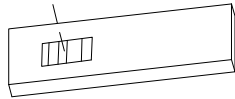
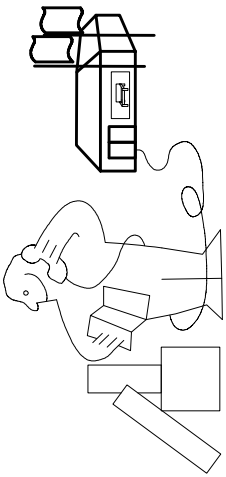
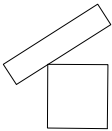
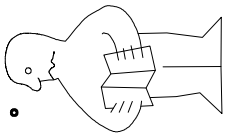

Modell/Model/Modèle



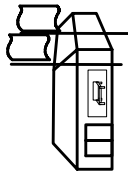

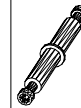
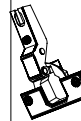
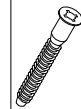

{121 370}

{ G 1 }

{4x}

Änderungen die dem technischen Fortschritt geschuldet sind, behalten wir uns vor!
Bei nicht vorschriftsmäßiger und/ oder nicht fachmännischer Montage wird bei Personen- und/ oder Sachschäden keinerlei Haftung übernommen.

WIMEX Wohnbedarf/ Import Export Handels GmbH/ Postfach 1407/ 49112 Georgsmarienhütte/ Germany
Tel.:(+49) 05401 8598 72 Fax.:(+49) 05401 8598 33 Mail: service_H@wimex-online.com

980828



1.

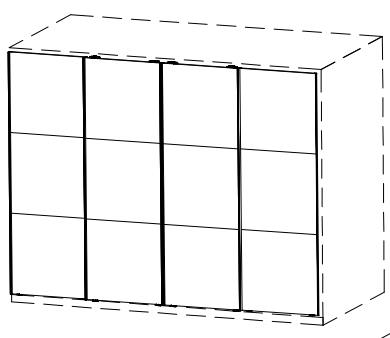
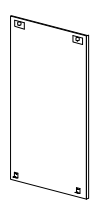

2.

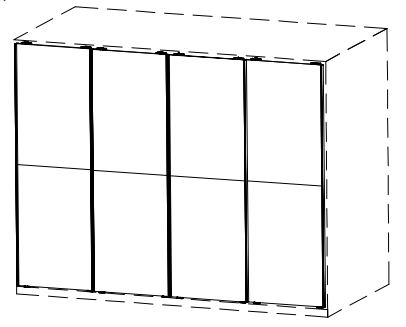
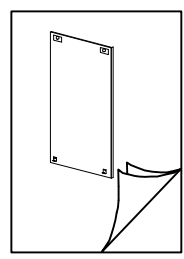
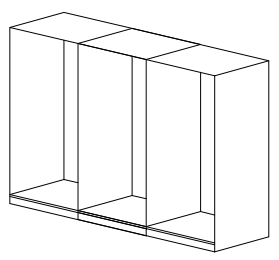
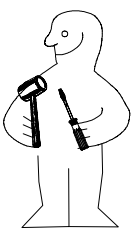

300 HSP Syncro

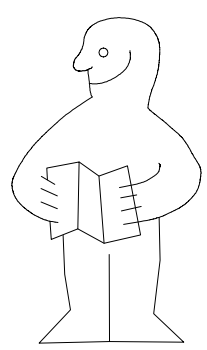
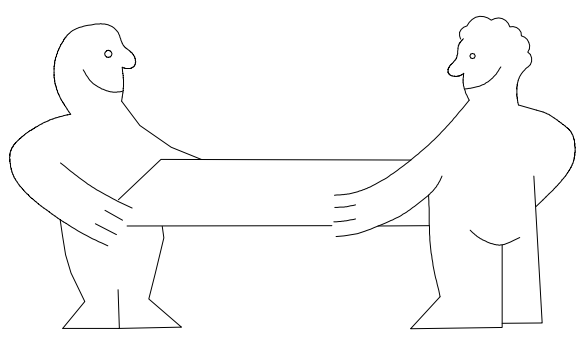
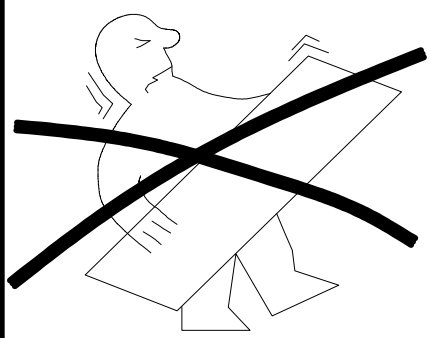

1-2-3-4... ○

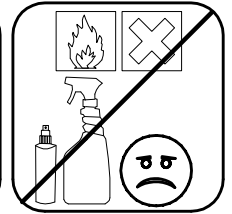
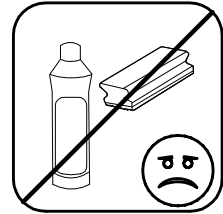
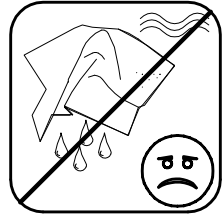
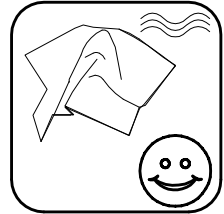
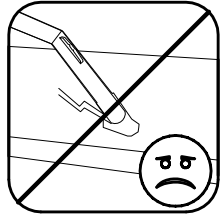
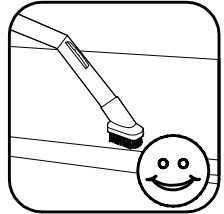
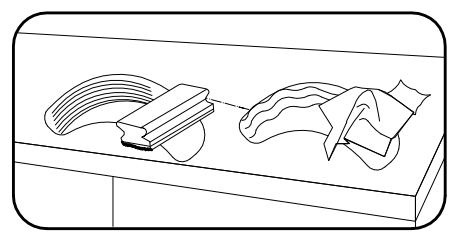
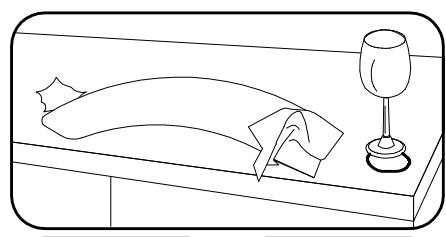
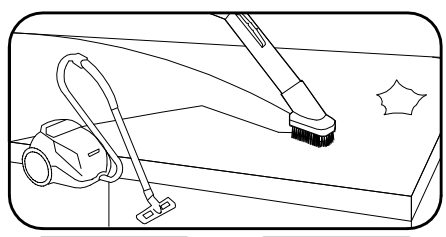
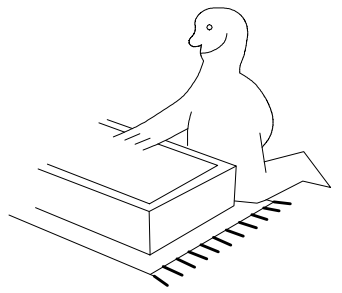
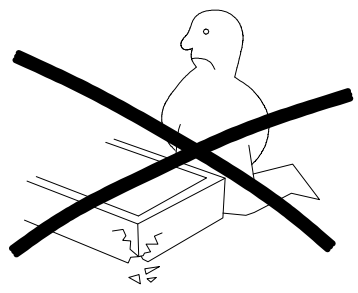
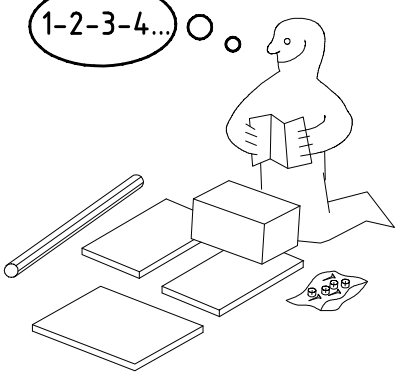

980828

03.12.16 / -

12 16

1/8

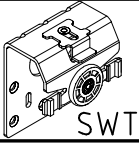
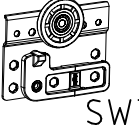
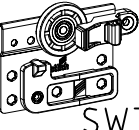
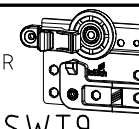
 SWT 1	4x
 SWT 2	2x
 SWT 8 L	1x
 SWT 9 R	1x

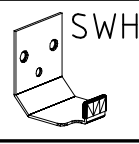
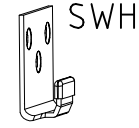
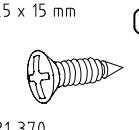
 SWH 6	4x
 SWH 7	4x
 3,5 x 15 mm G1 121 370	2x

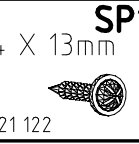
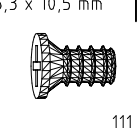
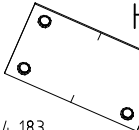
 4 X 13mm SP13 121 122	120x 136x
 6,3 x 10,5 mm T2 111 030	48x
 H5 114 183	4x 8x

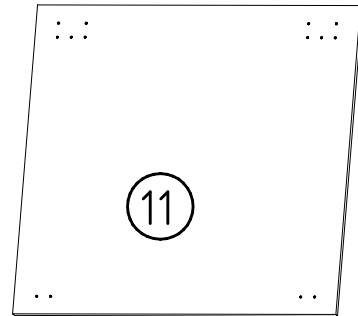
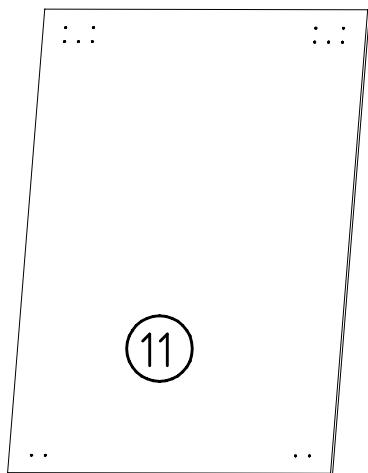
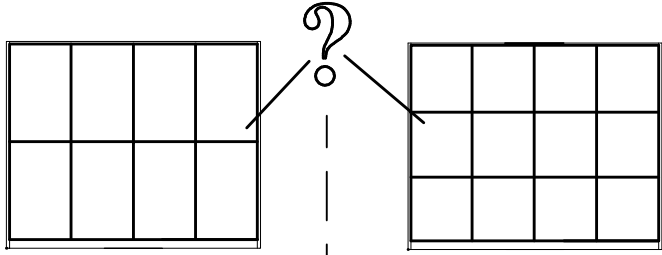
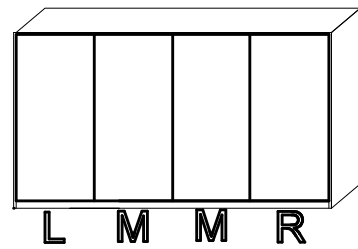
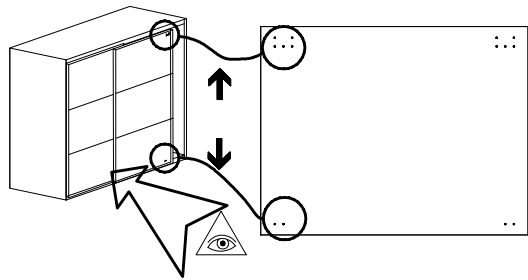
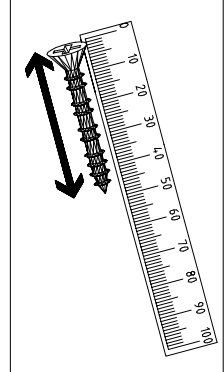
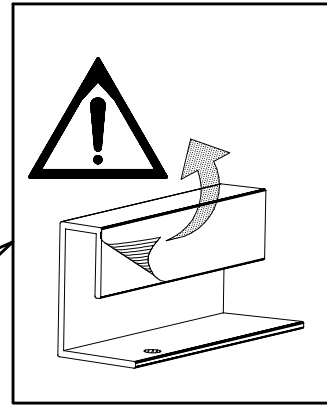
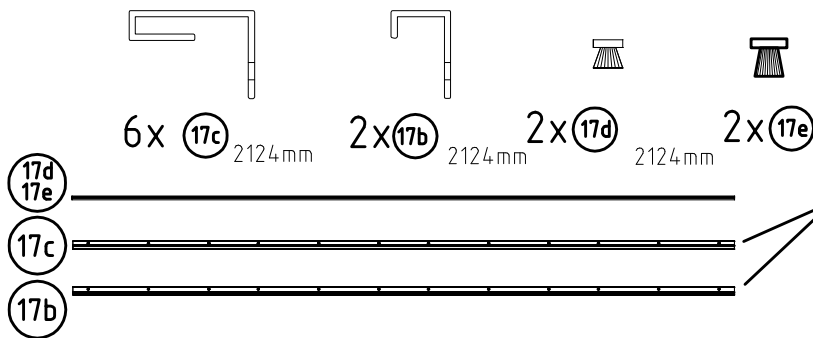
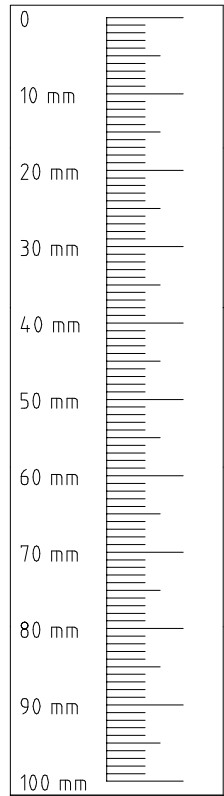
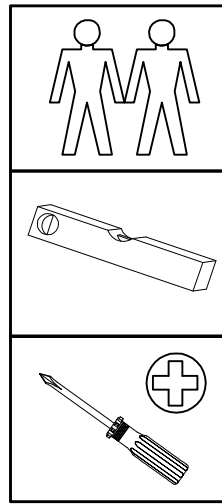

1

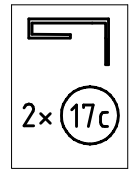
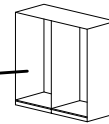
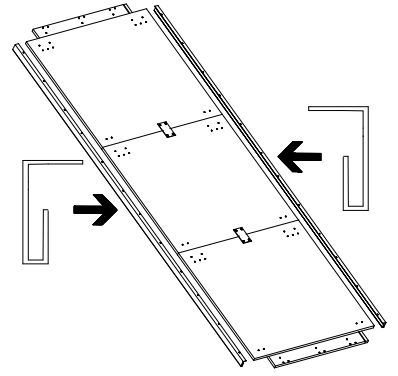
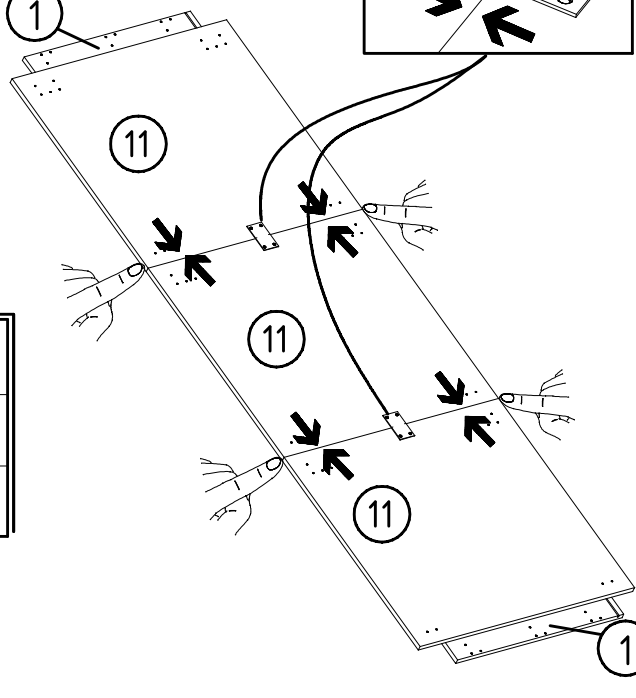
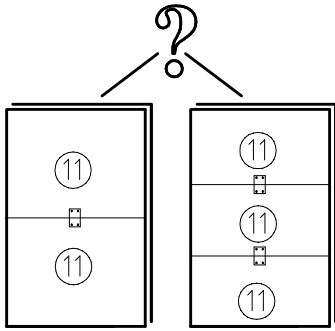
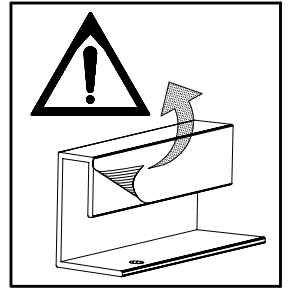
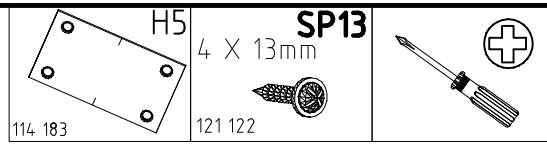
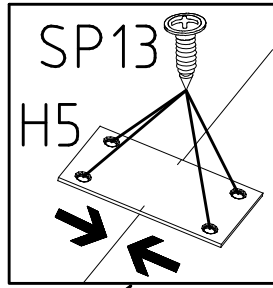
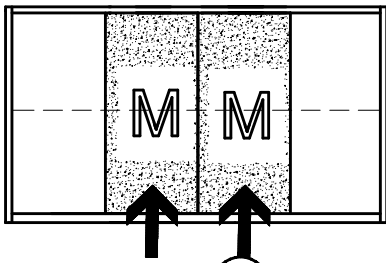

2

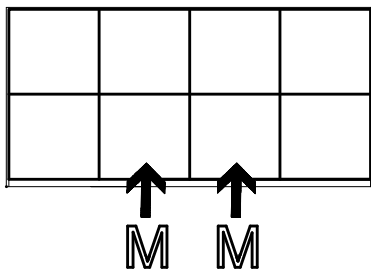
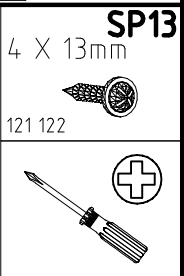
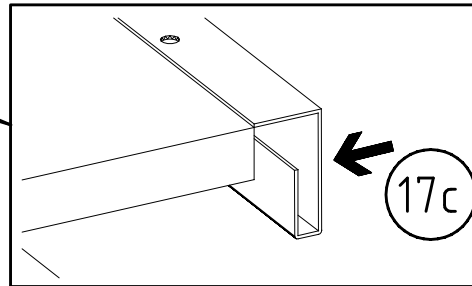
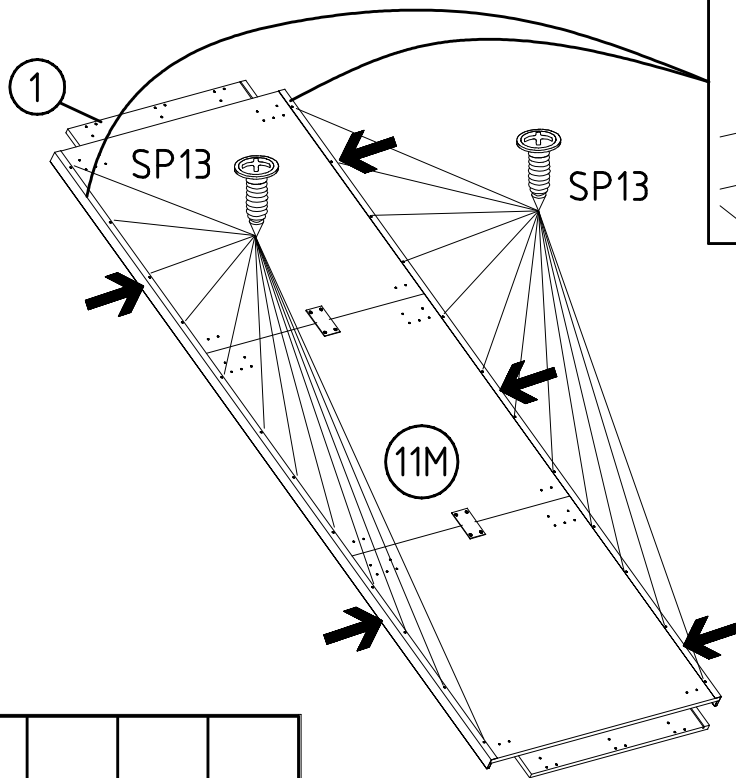

3

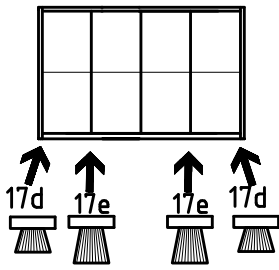
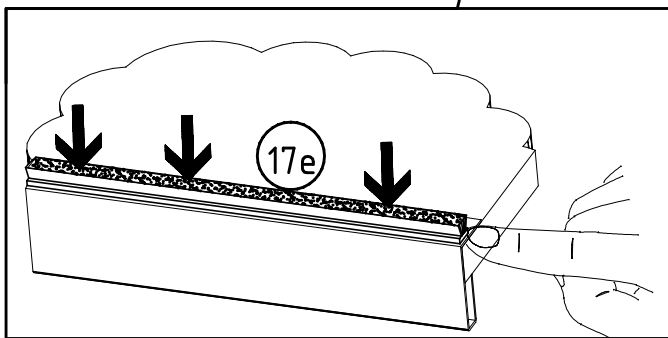
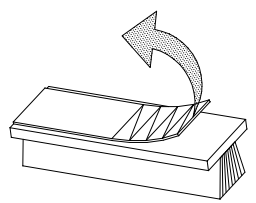
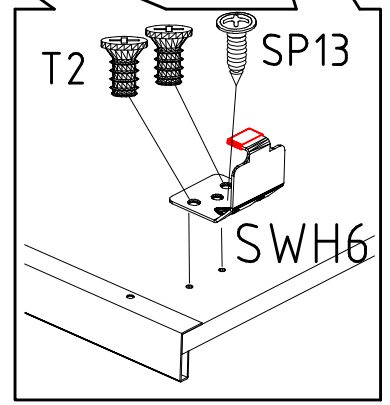
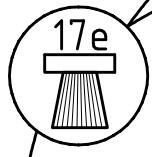
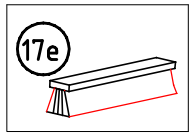
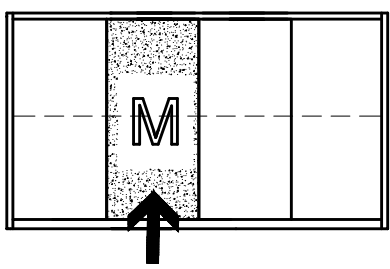
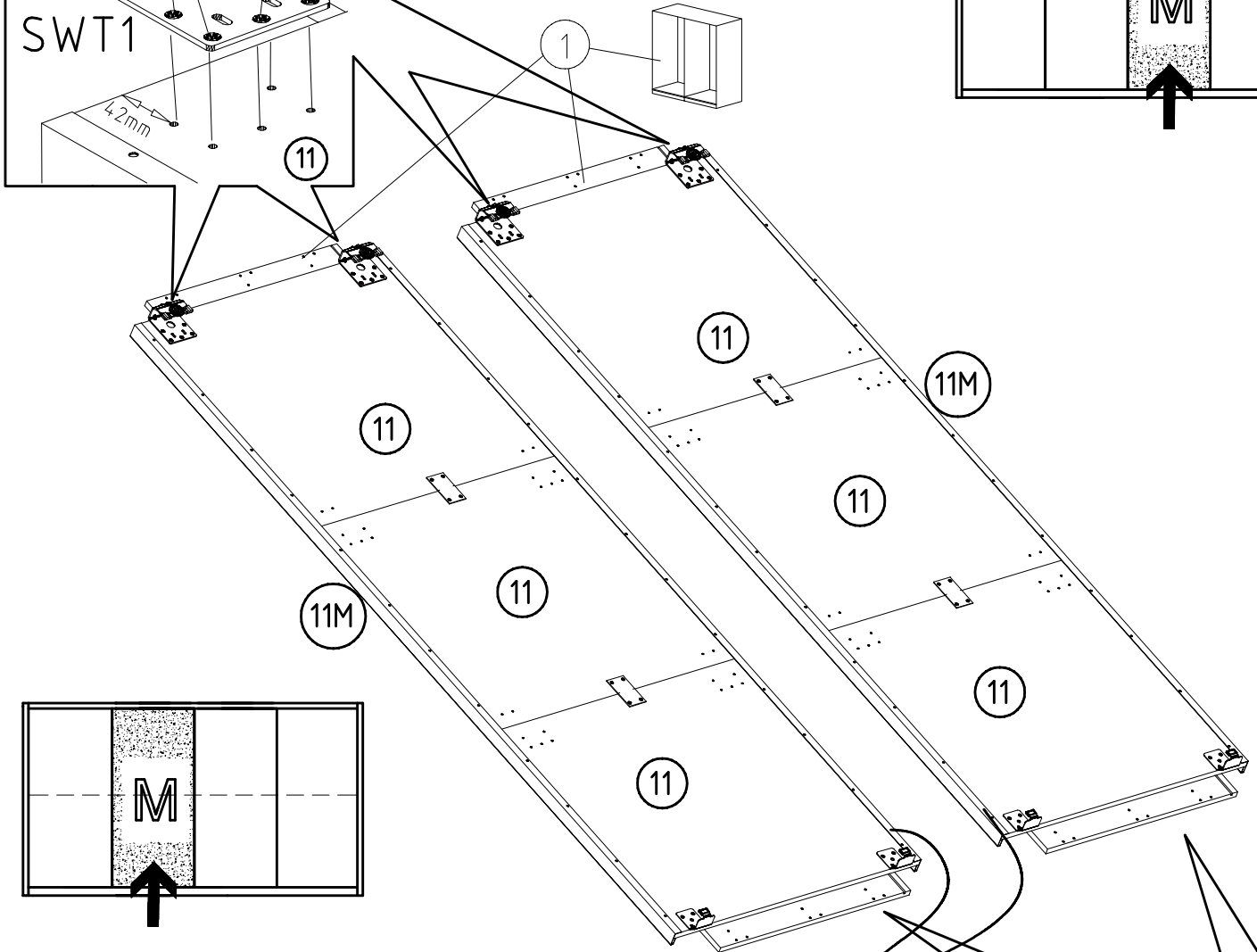
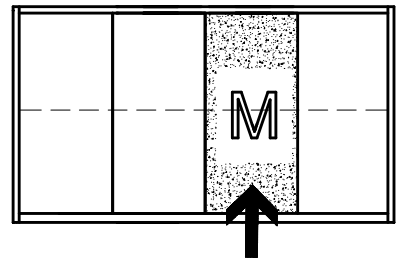
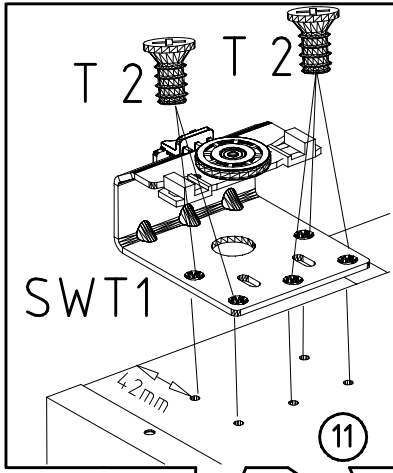
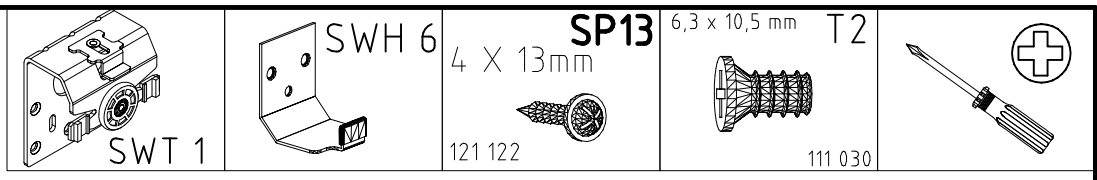

4

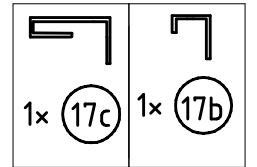
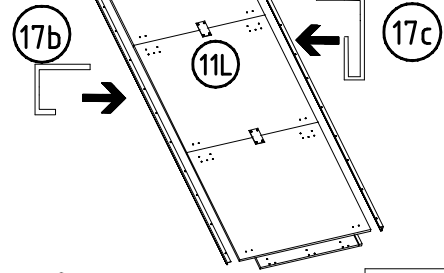
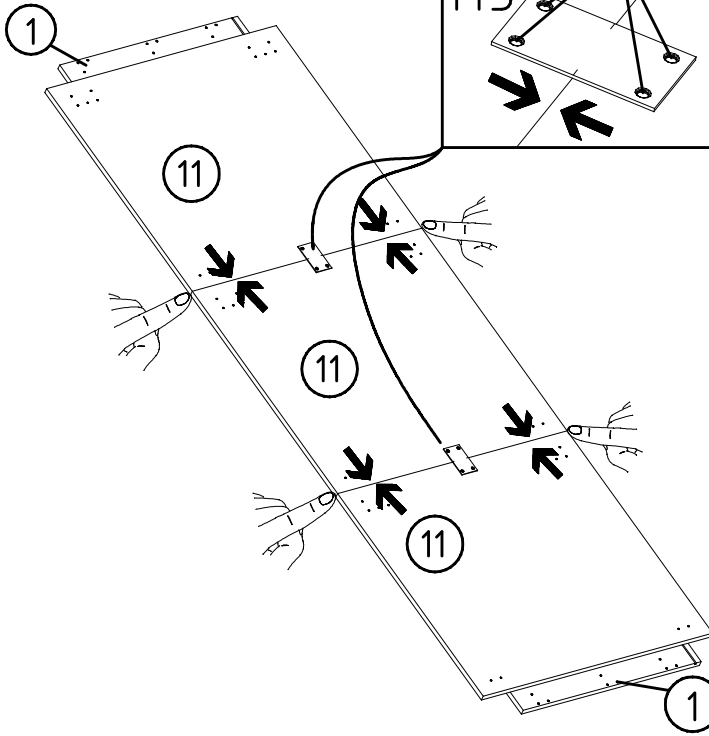
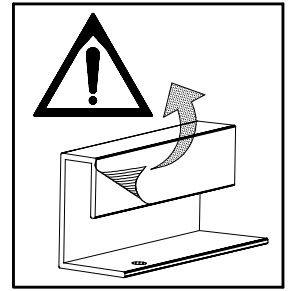
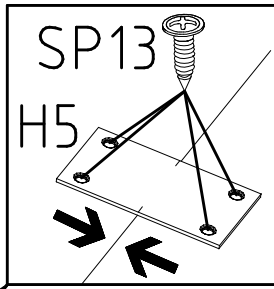
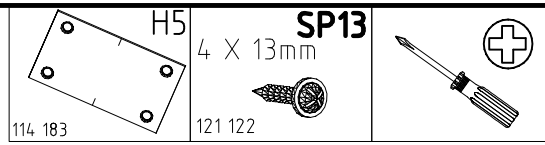
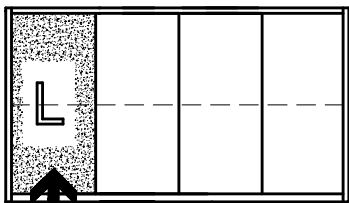

5

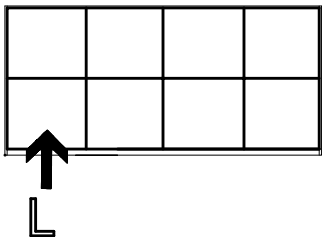
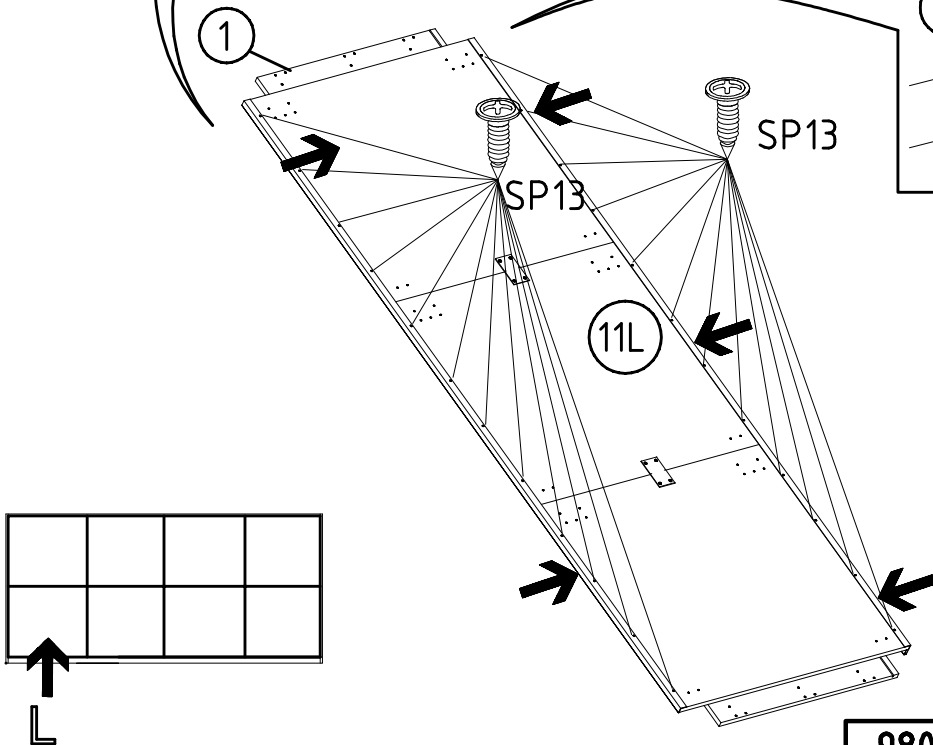
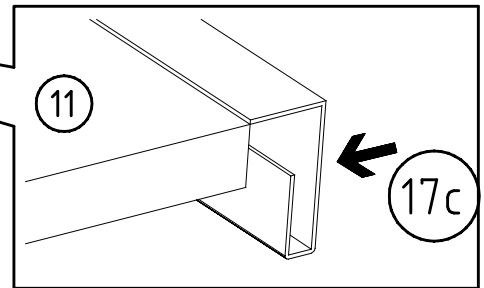
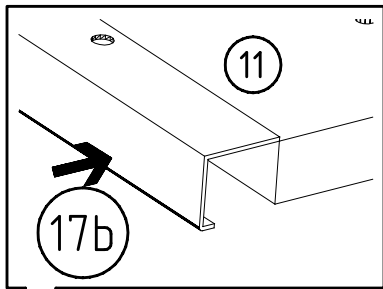
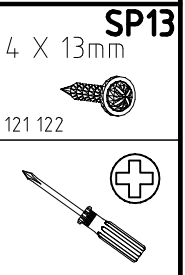

6

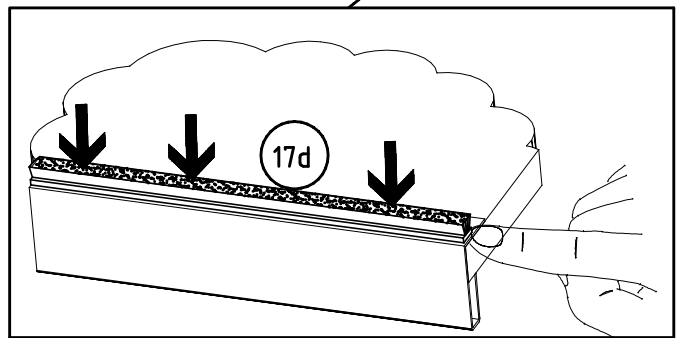
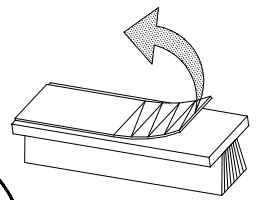
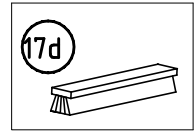
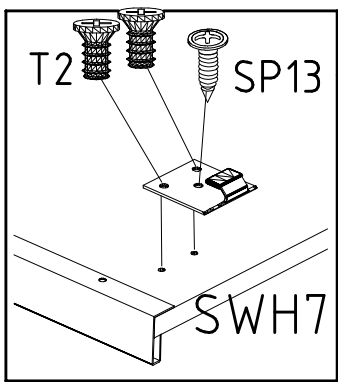
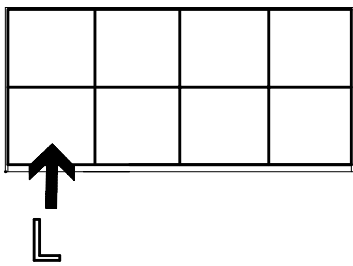
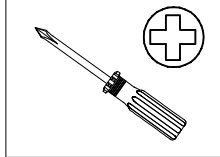
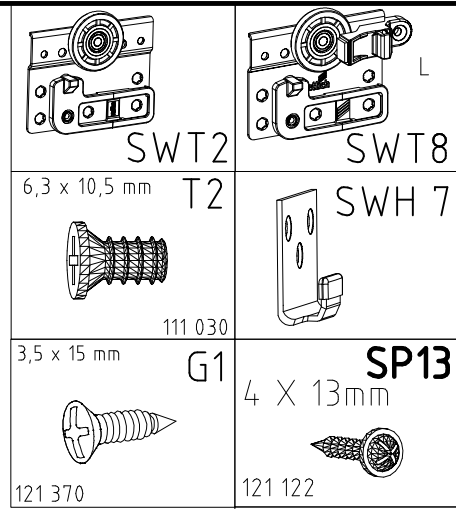
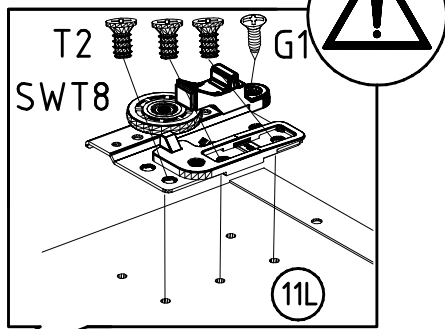
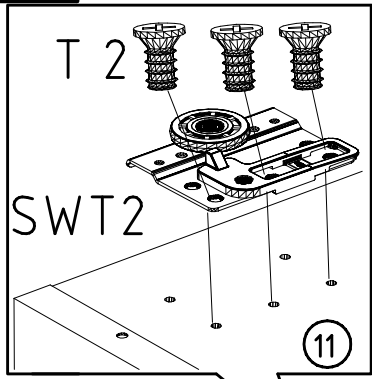

7

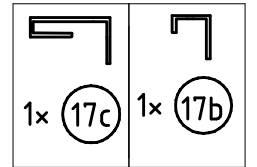
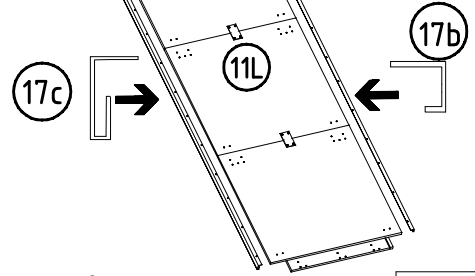
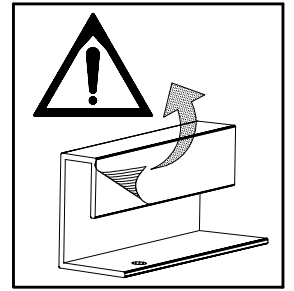
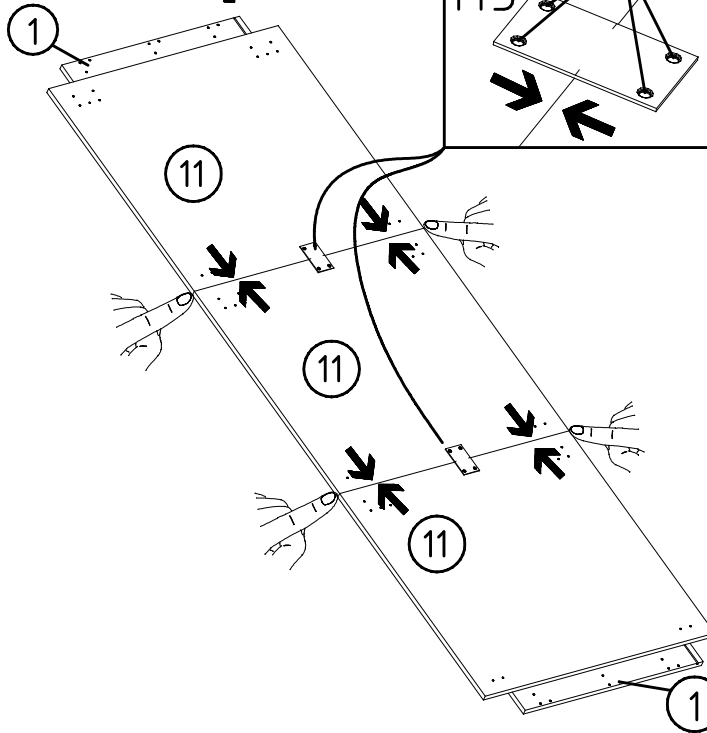
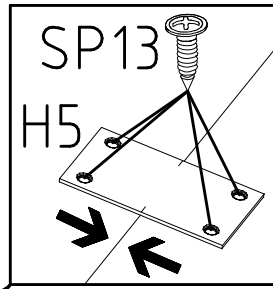
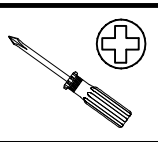
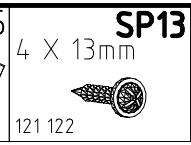
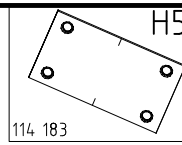
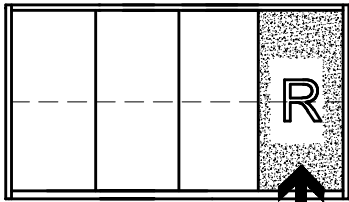

8

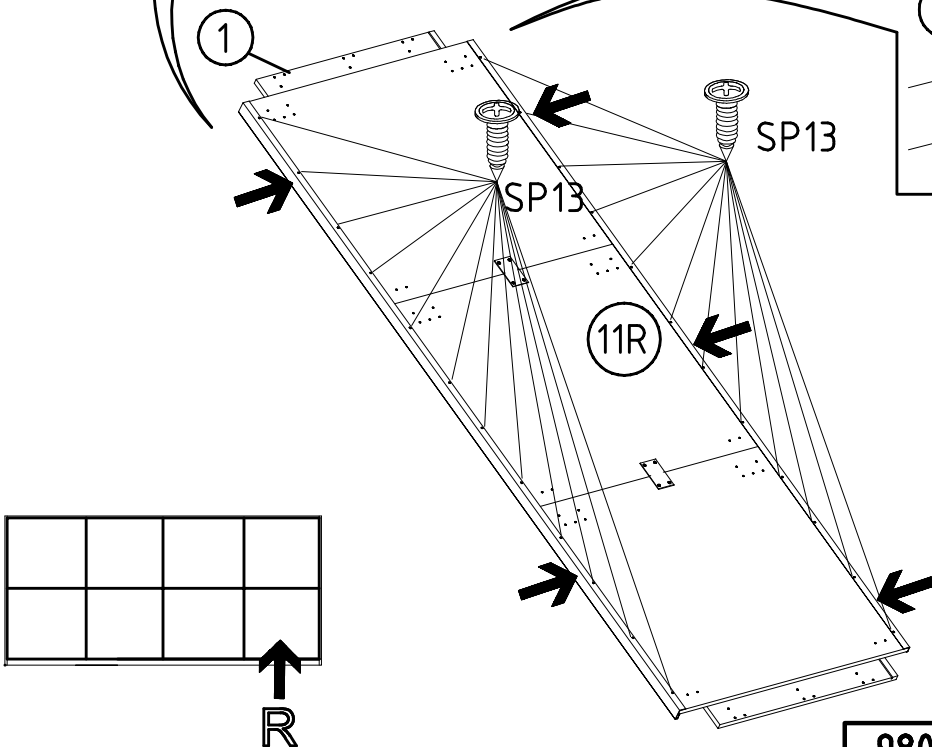
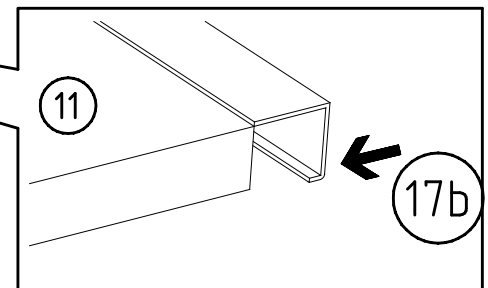
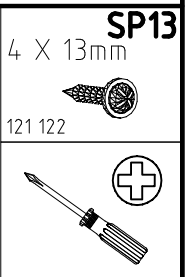
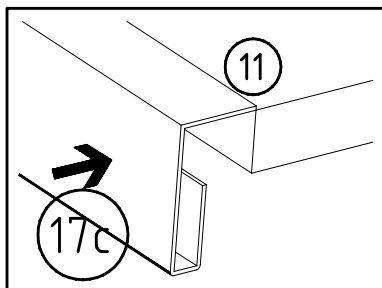

9

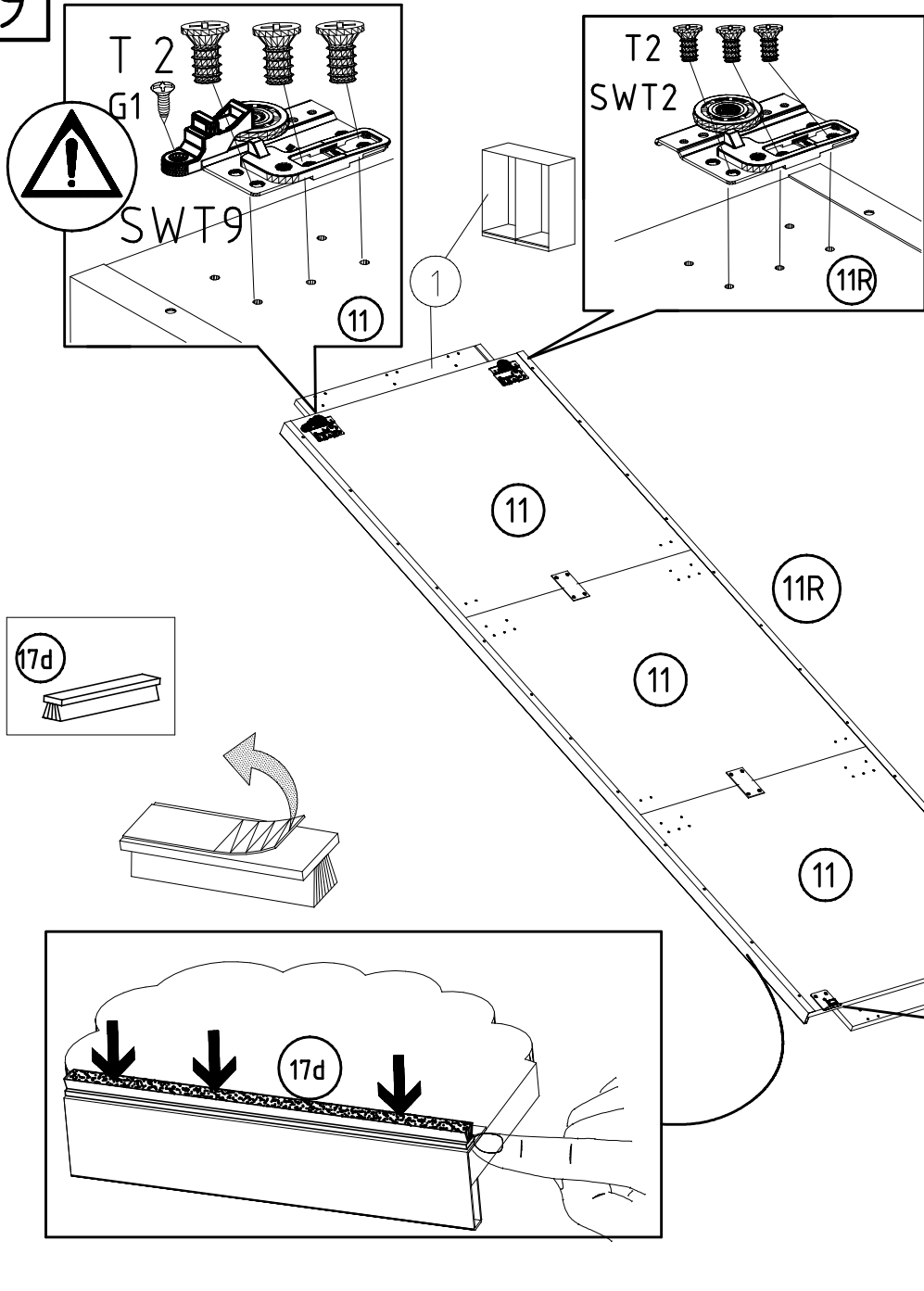

SWT2	SWT9
6,3 x 10,5 mm T2	SWH 7
111 030	
3,5 x 15 mm G1	4 X 13mm SP13
121 370	121 122

