

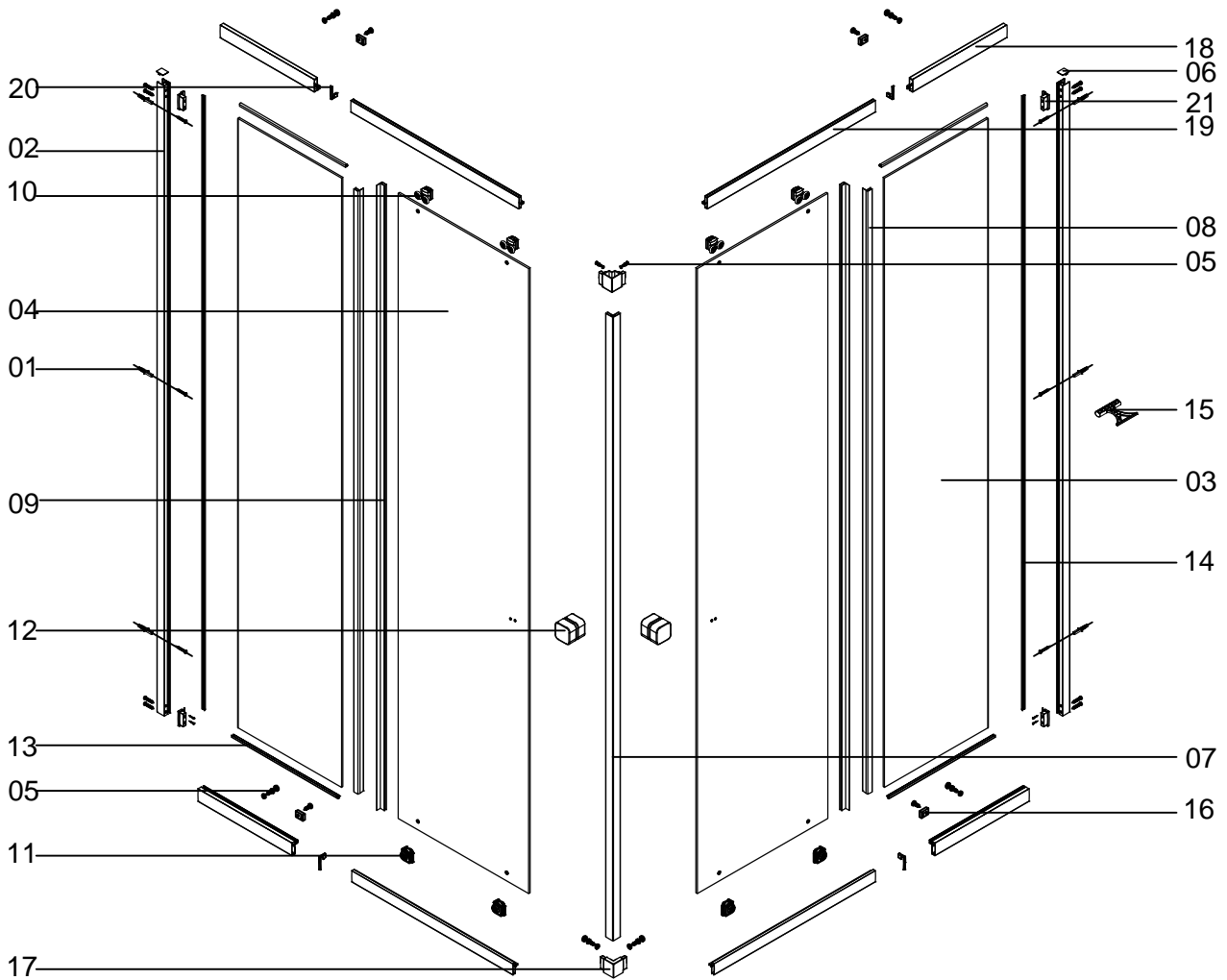











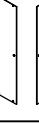



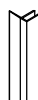
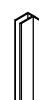

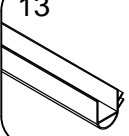

FAC800  
(770-900)X(770-900)X1900m  
FAC801  
(770-900)X(770-900)X1900mm

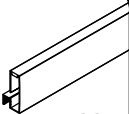

- |  |   |   |   |   |  |
|--|---|---|---|---|--|
| 01<br><br>ST4X25 X6 | 02<br><br>X2 | 03<br><br>X1         | 04<br><br>X1       | 05<br><br>ST4X8 X8 | 06<br><br>X2        |
| 07<br><br>X1        | 08<br><br>X2 | 09<br><br>X2         | 10<br><br>X4       | 11<br><br>X4       | 12<br><br>ST4X40 X2 |
| 13<br><br>X4        | 14<br><br>X2 | 15<br><br>X1         | 16<br><br>ST4X8 X4 | 17<br><br>X2       | 18<br><br>X4        |
| 19<br><br>X4        | 20<br><br>X2 | 21<br><br>ST3.5X16X2 |   |   |  |



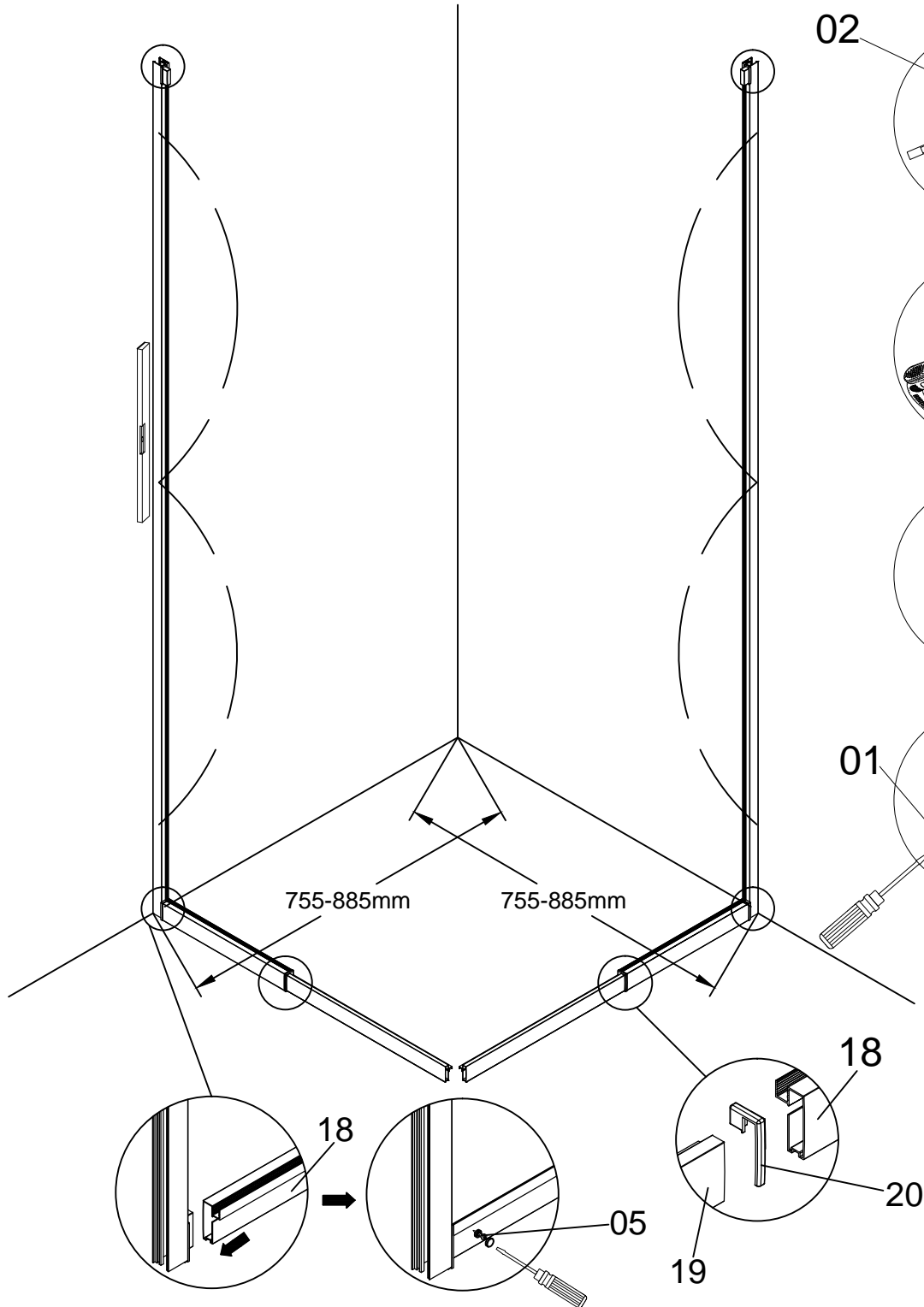
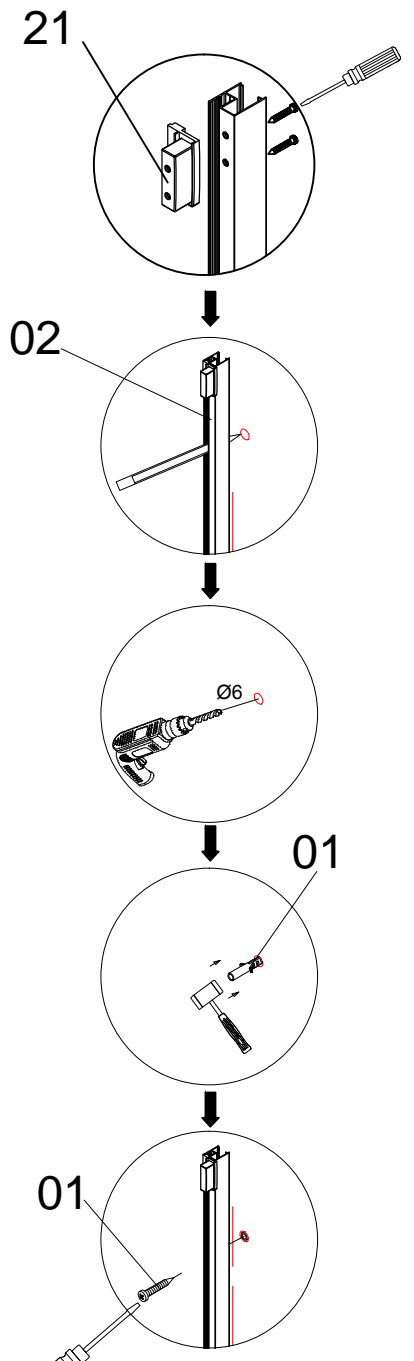
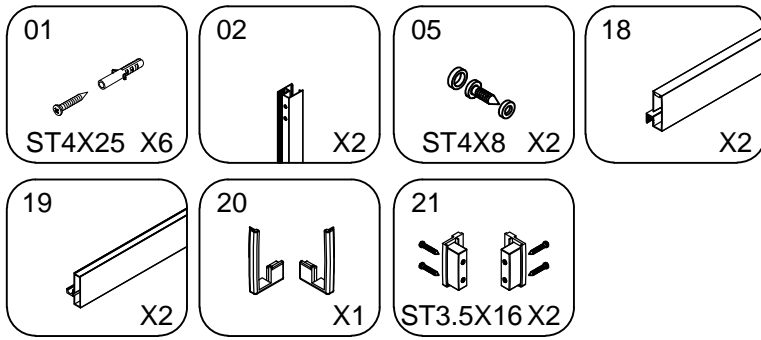
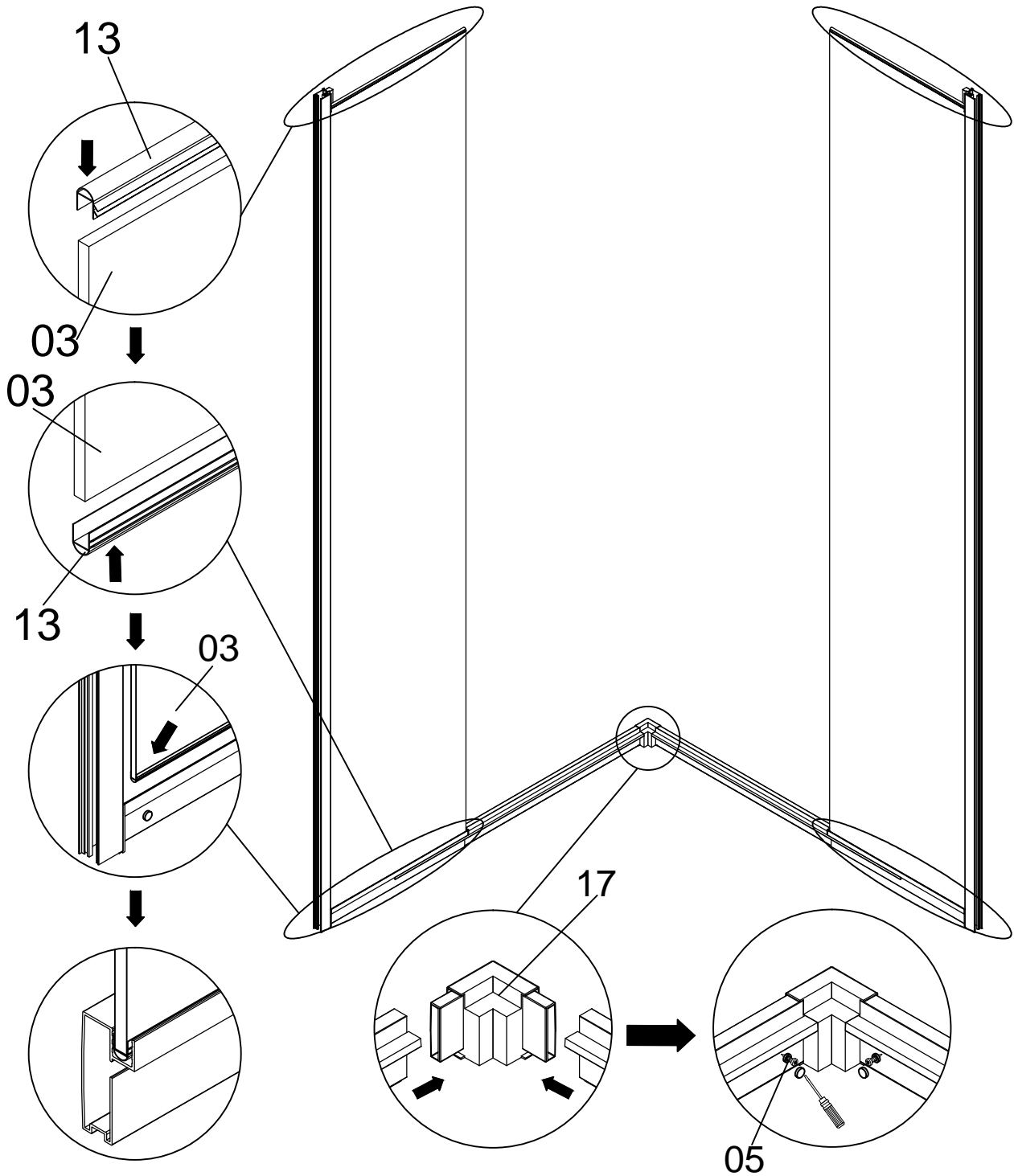
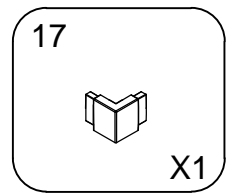
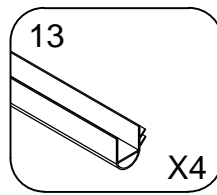
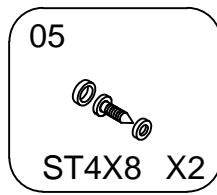
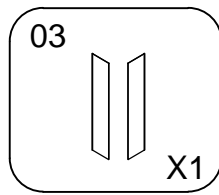

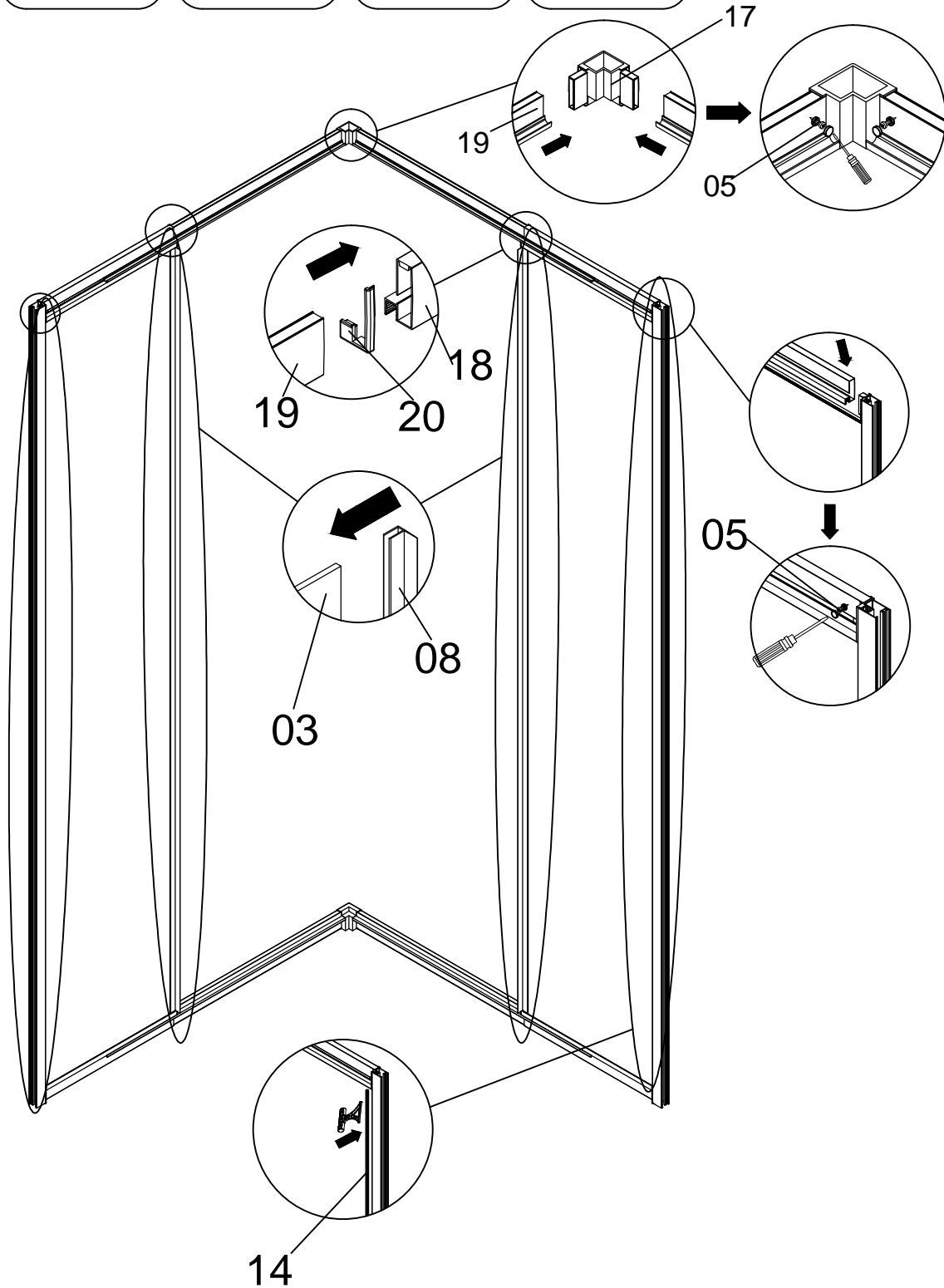
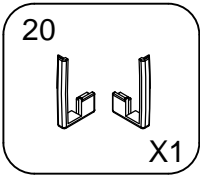
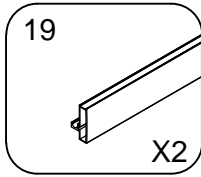
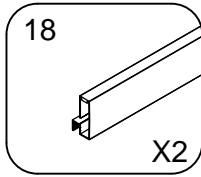
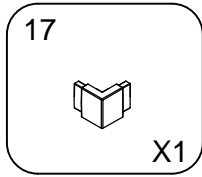
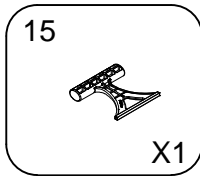
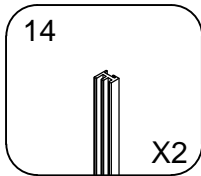
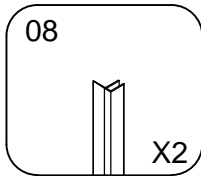
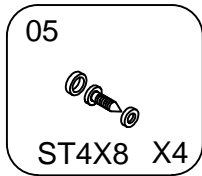

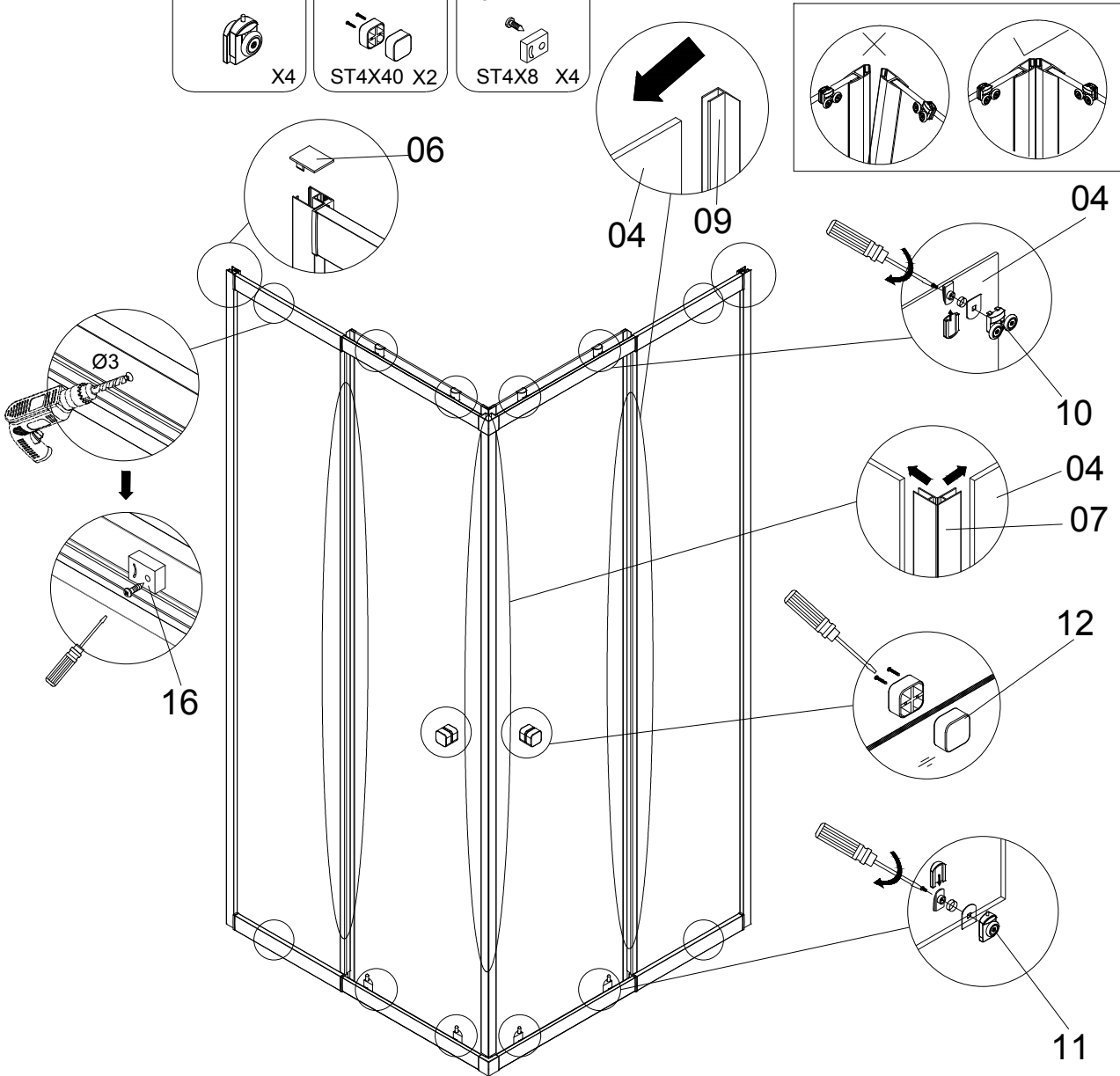
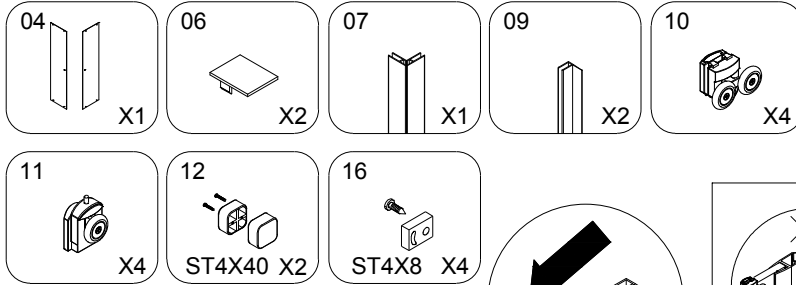

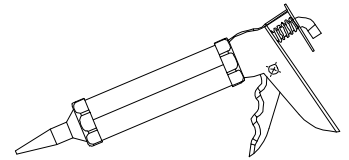
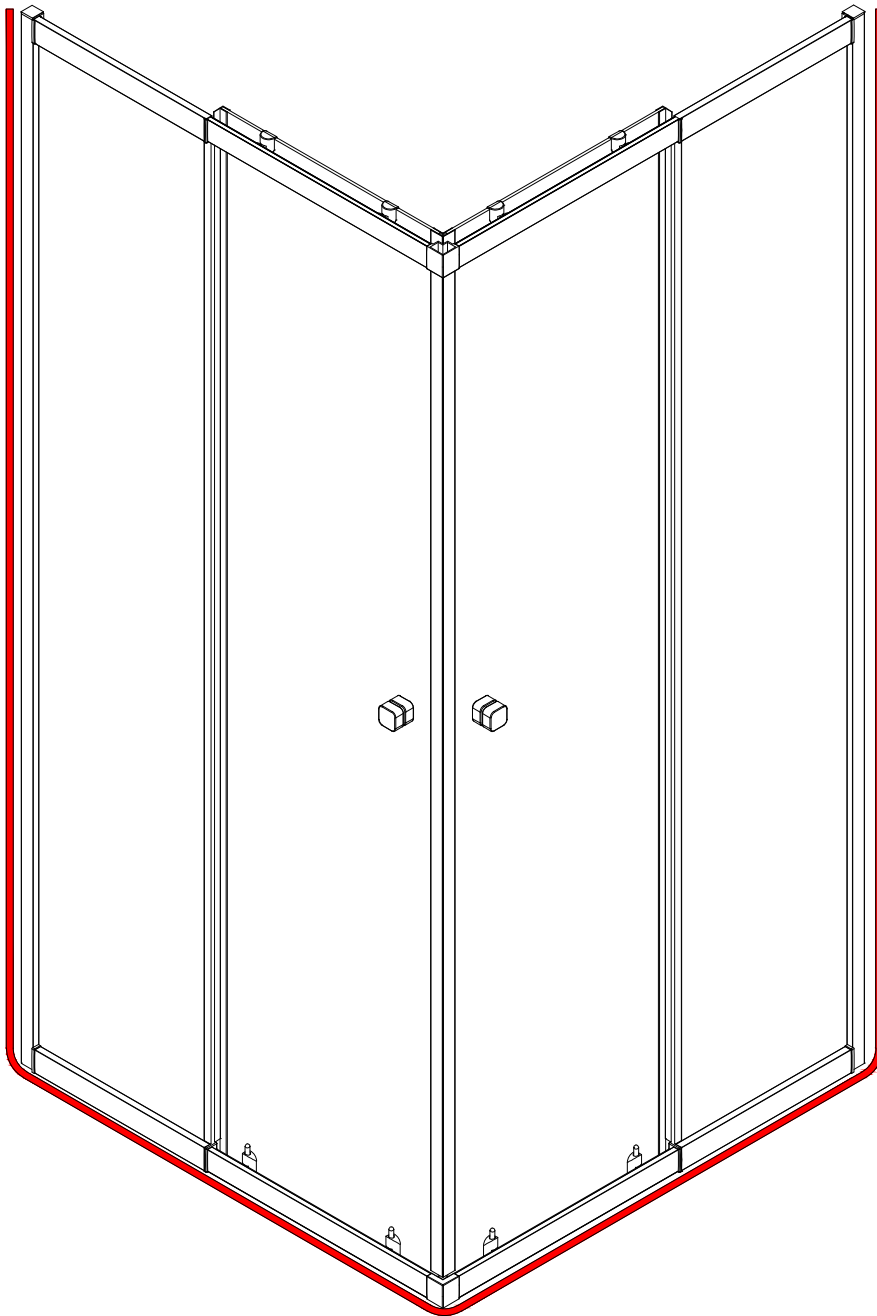
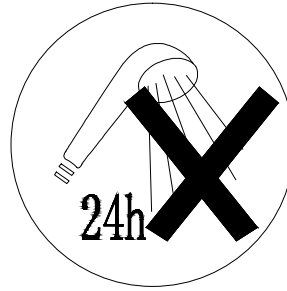
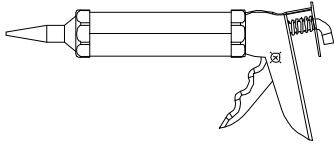

## DE

### Vor dem Einbau unbedingt lesen

1/ Für die Produkte von Aurlane gewähren wir eine **2-jährige Garantie auf Ersatzteile**. Da wir nicht für den Einbau zuständig sind, gewährt Aurlane keine Garantie auf die Arbeitsleistung. Bei festgestellten Herstellungsfehlern oder Schäden können die betroffenen Komponenten bei dem Händler bestellt werden, der das Produkt verkauft hat. Jedoch übernimmt Aurlane in keinem Fall die Arbeitsleistung für den Austausch der Komponente.

2/ Der Zustand jeder Komponente muss beim Auspacken kontrolliert werden. Nach einem Zeitraum von 7 Tagen ab dem Kauf des Produkts werden keine Reklamationen zur Produktqualität mehr angenommen.

### Montage

Wir möchten Sie darauf aufmerksam machen, dass der Aufbau von mindestens zwei Personen durchgeführt werden muss, damit die Elemente zugleich festgehalten und befestigt werden können.

- Die Glasteile bestehen auf Grund der Sicherheitsnormen aus Sekuritglas. Das Sekuritglas wird so hergestellt, dass es beim Aufprall in unzählige (nicht schneidende) Einzelteile explodiert, darum müssen diese Teile sehr vorsichtig gehandhabt werden. Aus dem gleichen Grund ist es zwingend notwendig, bei der Befestigung der Accessoires an den Glaselementen (Türgriffe, Tablett, Duschhalterung, Handtuchhalter usw.) Vorsicht walten zu lassen.

### Benutzung

- Um jeder bakteriellen Infektion vorzubeugen, ist es wichtig, die Duschkabine regelmäßig zu reinigen. Bitte beachten Sie dafür die Reinigungsempfehlungen und verwenden Sie nicht jede Art von Reinigungsprodukten.
- Achtung: Verwenden Sie keine Reinigungsmittel, die Azeton, Chlor oder Ammoniak enthalten. Die Verwendung solcher Produkte führt automatisch zu einer rapiden Abnutzung der Chromteile (Bsp.: Massagedüsen, Armaturen, Duschkopf usw.) und einer Vergilbung der Acrylteile (Bsp.: Wanne und Dach).
- Achtung bei der Nutzung der Kabine durch Kinder: Gestatten Sie die Nutzung ohne Überwachung nur verantwortungsbewussten Kindern, die von ihren Eltern Anweisungen erhalten und verstanden haben, wie eine solche Duschkabine funktioniert. Es ist dennoch nicht empfohlen, die Nutzung der Kabine durch Kinder ohne Beaufsichtigung der Eltern zu gestatten. Letztere müssen sicherstellen, dass das Kind nicht mit der Duschkabine spielt.
- Diese Kabine darf nicht von Personen (Kinder eingeschlossen) benutzt werden, die über eine eingeschränkte Mobilität oder eingeschränkte sensorische oder mentale Fähigkeiten verfügen, es sei denn, sie befinden sich unter Aufsicht oder haben Anweisungen durch die für ihre Sicherheit zuständigen Personen erhalten.

## DE

- Verwenden Sie keine anderen elektrischen Geräte im Inneren der Kabine, insbesondere keine Geräte, die Dampf erzeugen oder Luftbefeuchter.

## EN

### Be sure to read before installing

1 / We grant a 2-year warranty on spare parts for AURLANE products. Since we are not responsible for the installation, AURLANE does not guarantee work performance. If manufacturing defects or damage are found, the affected components can be ordered from the dealer who sold the product. However, AURLANE will never undertake the work for replacing the component.

2 / The condition of each component must be checked when unpacking. No complaints about product quality will be accepted after a period of 7 days from the purchase of the product.

### Installation

- We would like to call attention to the fact that the installation must be performed by at least two persons, ensuring that the elements can be held secure and mounted at the same time.
- Due to the safety standards, the glass parts are made of tempered safety glass. The tempered safety glass has been produced in such a manner that it explodes into numerous (non-cutting) pieces; therefore, these parts must be handled with particular care. For the same reason, it is absolutely necessary to act with great care during the mounting of the accessories to the glass elements (door handles, trays, shower head holder, towel rack, etc.).

### Usage

- In order to prevent any bacterial infection, it is important to clean the shower cubicle regularly. For this, please observe the cleaning recommendations and note that not all types of cleaning products are suitable.
- Caution: Do not use cleaning agents that contain acetone, chlorine or ammonia. The use of such products will automatically cause rapid wear of the chrome parts (e.g. massage nozzles, fittings, shower head, etc.) and lead to the yellowing of the acrylic parts (e.g. tub and roof).
- Caution during the use of the cubicle by children: Only allow the unsupervised use to responsible children, who have received instructions from their parents and have understood how such a shower cubicle works. Nevertheless, it is not recommended to permit children to use the cubicle without parental supervision. The latter must prevent that the child does not play with the shower cubicle.
- This cubicle may not be used by persons (including children) that have limited mobility or limited sensory or mental capabilities, except when they are supervised or have received instructions from the persons responsible for their safety.
- Do not use any other electrical devices inside the cubicle, in particular no air humidifiers or devices that generate steam.

Essential characteristics	Performance	Harmonised Technical Specification
Cleanability	PASS	BS EN 14428: 2018
Impact resistance/shatter properties	PASS	
Durability	PASS	



Aurlane Deutschland GmbH  
Rögen 52, DE-23843 Bad Oldesloe  
EN 14428: 2018  
DoP\_FAC-800-801