

(D) Montageanleitung  
 (FR) Notice de montage  
 (NL) Handleiding voor de montage

(GB) Assembly instructions  
 (IT) Istruzioni di montaggio  
 (PL) Instrukcja montażu

(CZ) Montážní návod  
 (HU) Szerelési útmutató  
 (TR) Montaj talimatı

(SK) Návod na montáž  
 (RU) Instrucțiuni de montaj  
 (RU) Инструкция по монтажу

Name \* Nom \* Nome \* Naaz \* Nazwa \* Jméno  
 Názov \* Név \* Denumire \* İsim \* Название

# BARCELONA

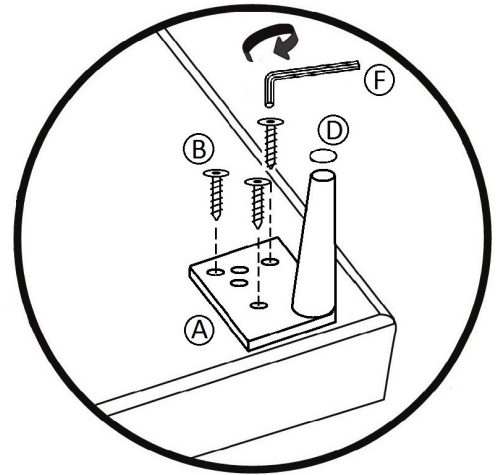
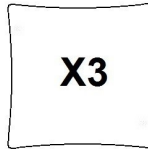
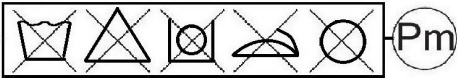
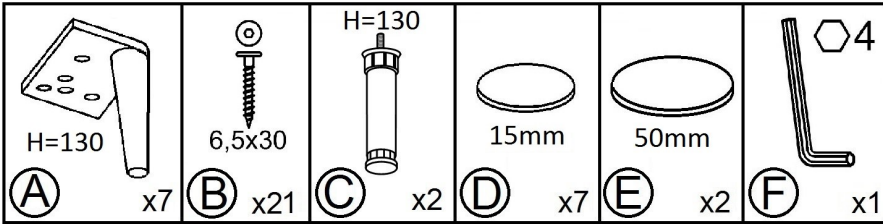
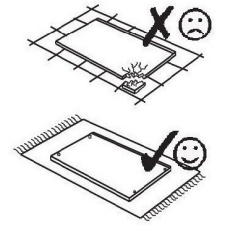
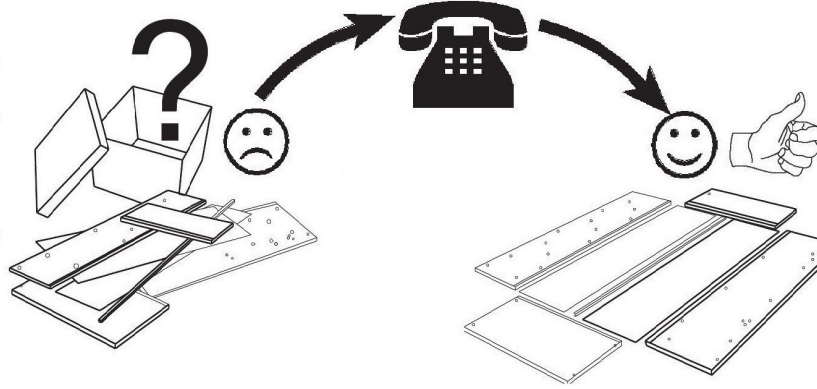
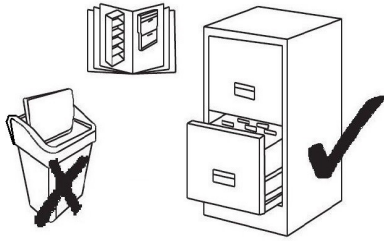

3S(1600)+OTM

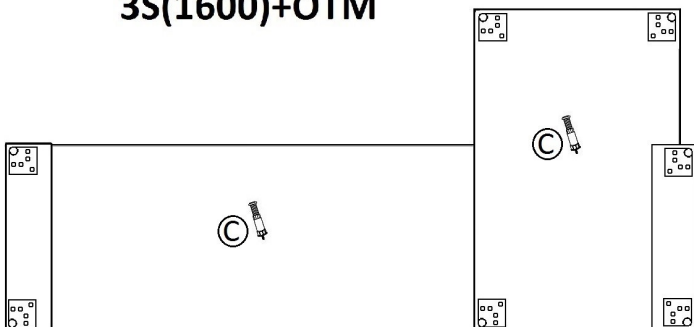

OTM+3S(1600)

