

# Simone

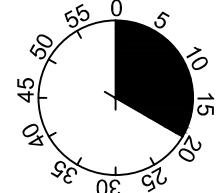

1

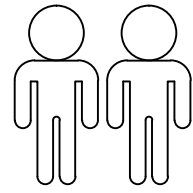
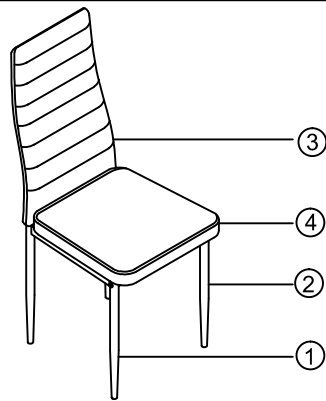
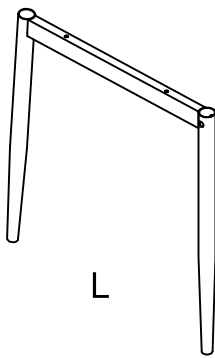

2

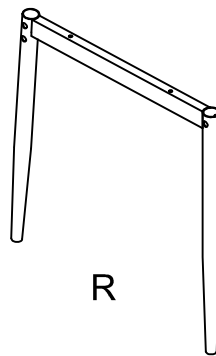

3

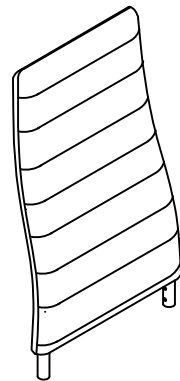

4

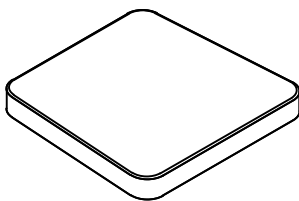

5

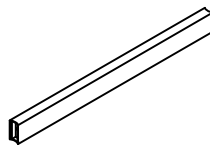

1	1X
2	1X
3	1X
4	1X
5	1X

**A**

M6x15

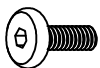

4x

**B**

M6x40



2x

**C**

M4x45



4x

**D**

4MM

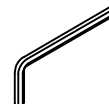



1x

I.

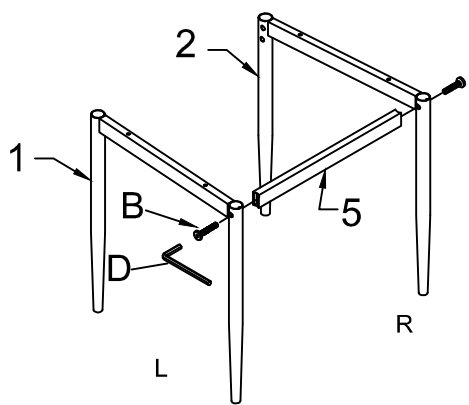

1



B		M6x40
		2x
D		4MM
		1x
		

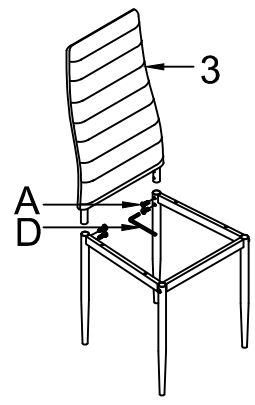

2

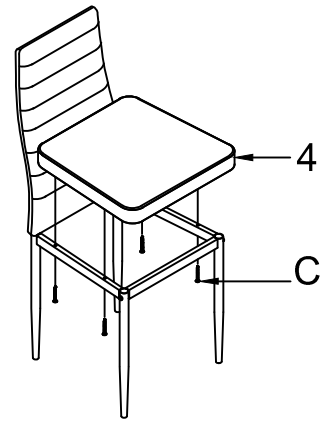

A		M6x15
		4x
D		4MM
		1x
		

3



C		M4X45
		4x
		

4

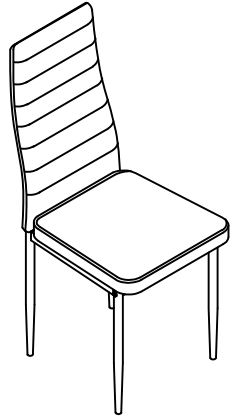

D		4MM
		1x
