

# MAL 110UH

**Achtung!** Gläser niemals ungeschützt auf den Boden stellen.  
Verletzung der Glaskante führt zu Glasbruch.

**Caution!** Never put glass walls on the floor without protection.  
Damaging the glass edges results in breaking of the glass.

**Attention!** Jamais placer des parois de douche en verre au sol sans protection. Des verres endommagés casseront.

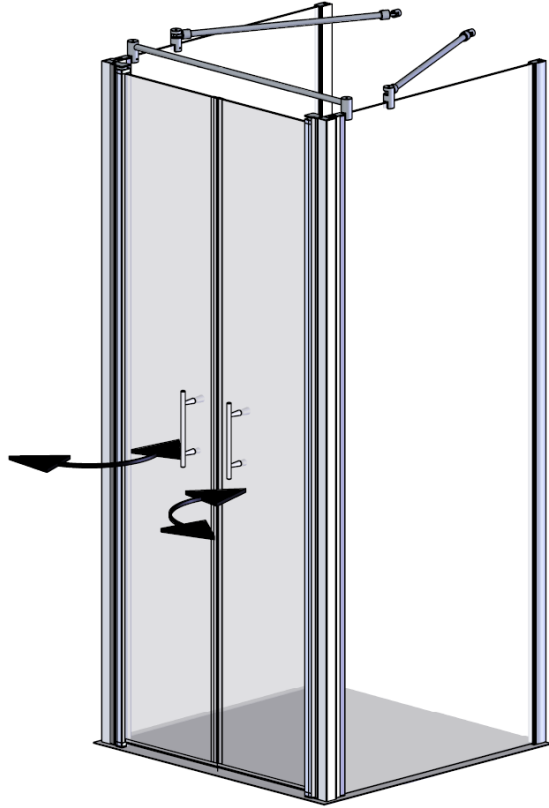

Die abgebildeten Formen der Profile und Griffe dienen der schematischen Darstellung und entsprechen nicht dem tatsächlichen Lieferumfang!



Mitgeliefertes Montagematerial  
supplied assembly material  
matériaux pour assemblage

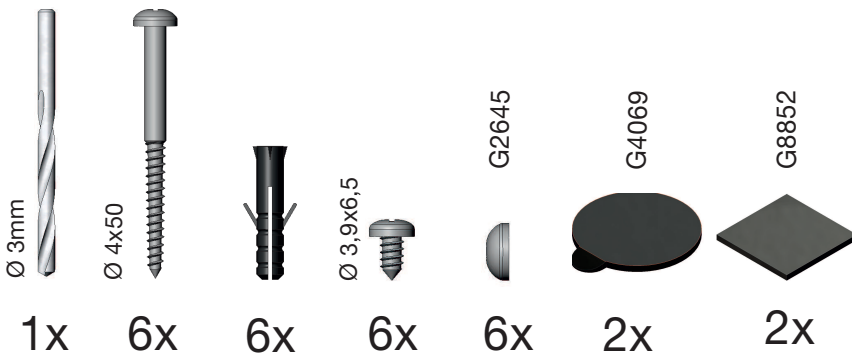

Zum Aufbau benötigen Sie  
for mounting you need  
pour l'installation il vous faut



5 Jahre  
Garantie

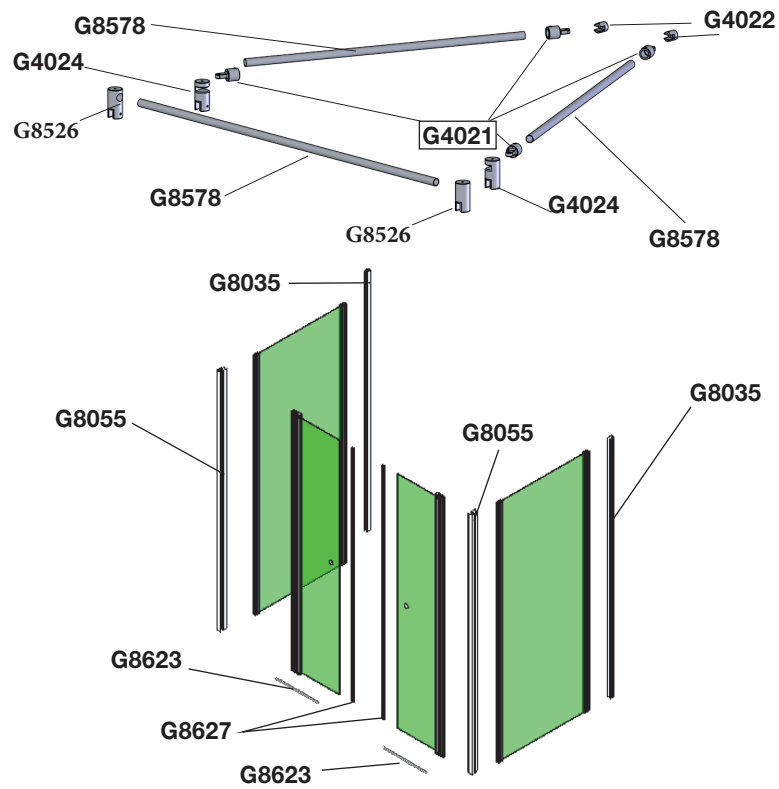

1

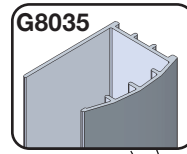
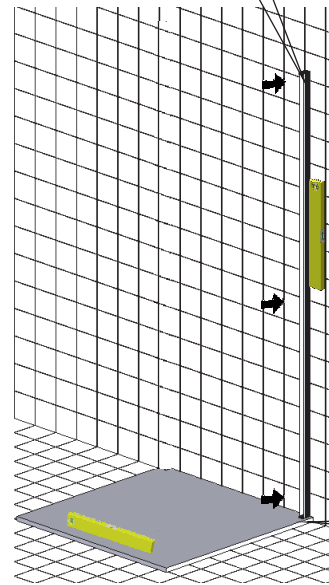

G8035

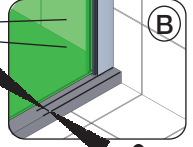
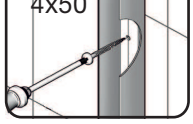
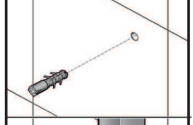
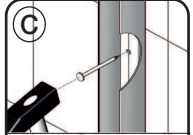
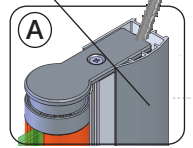

2

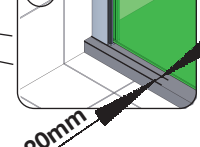
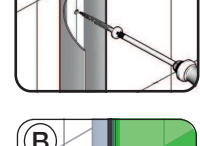
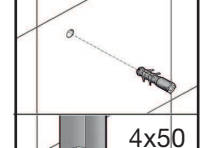
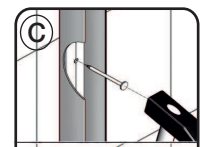
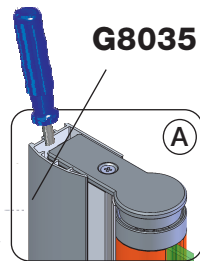
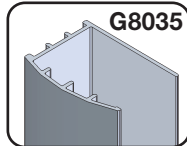
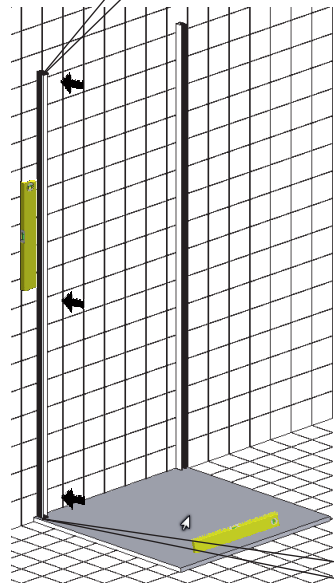

3

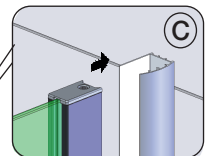
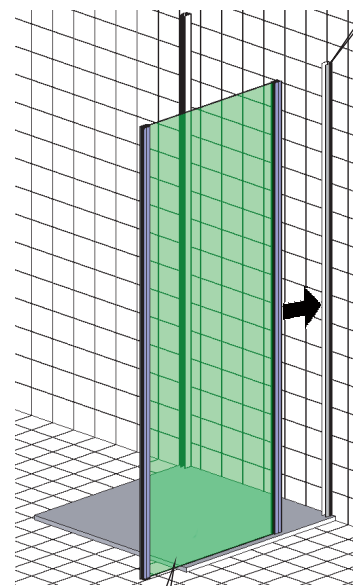

max. 20mm

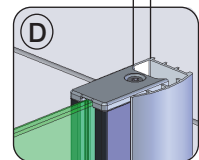

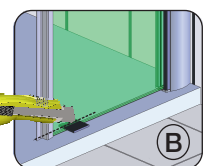
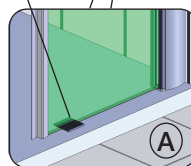

G8852

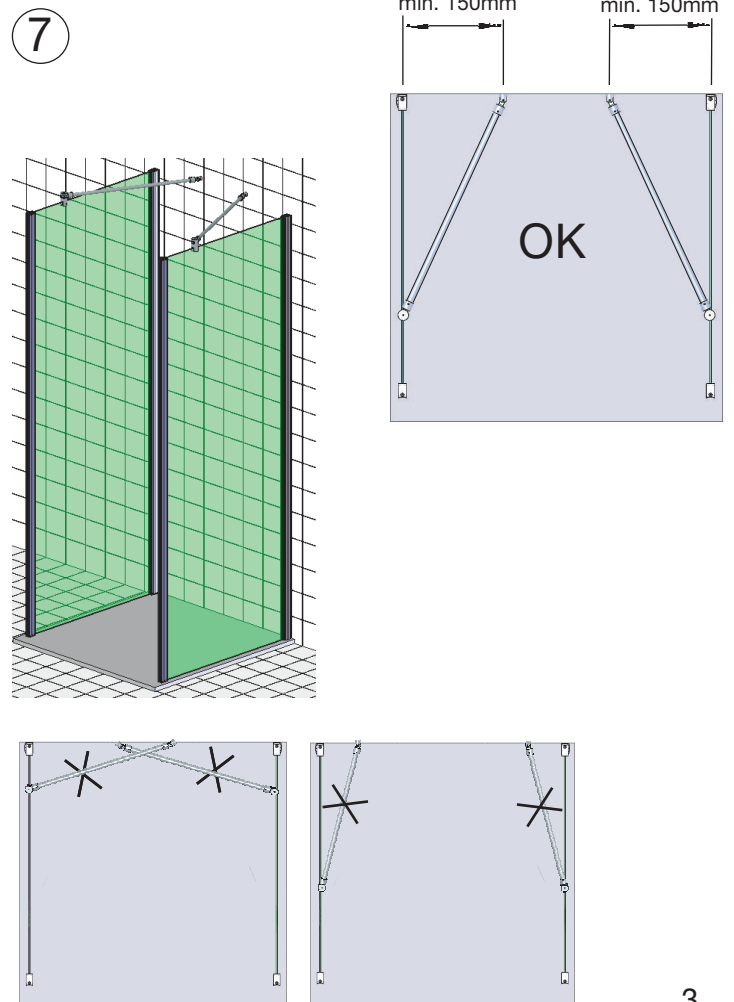
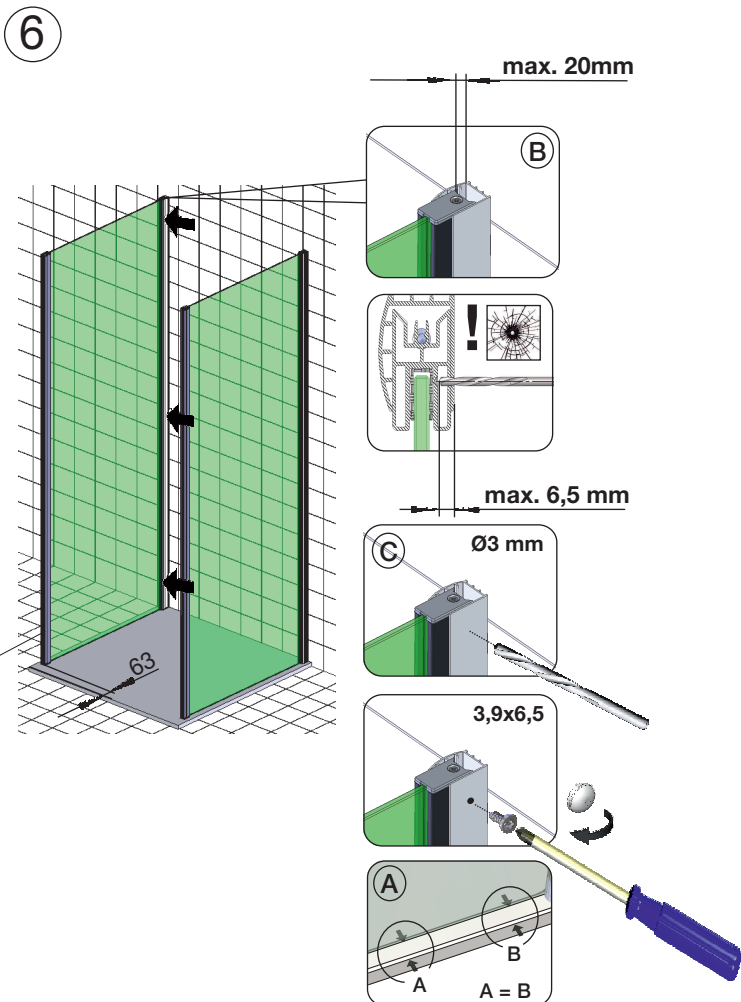
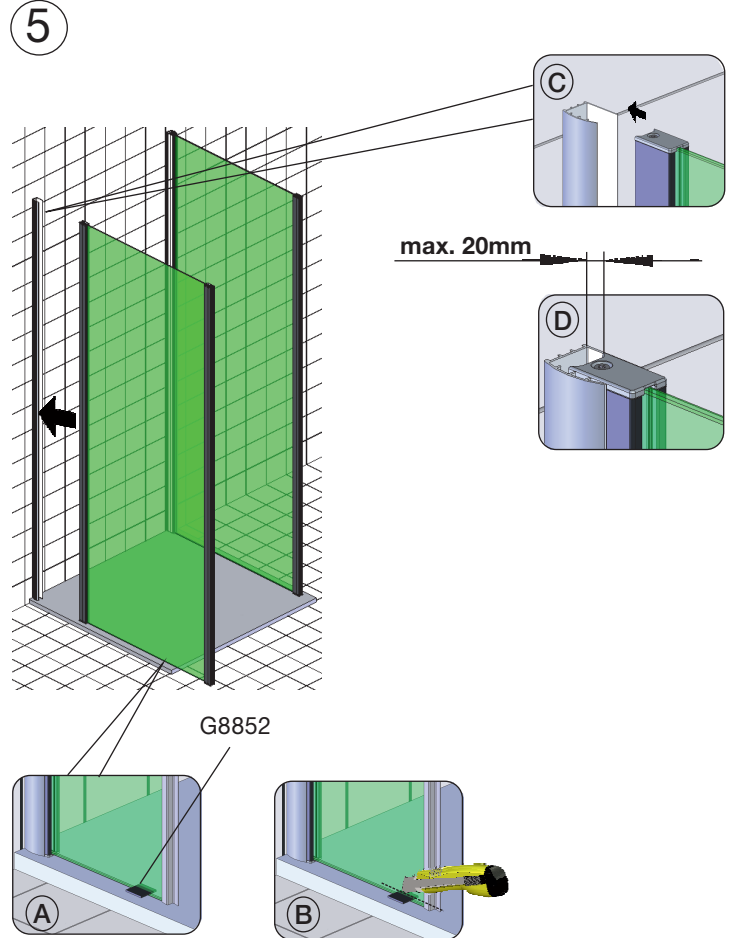
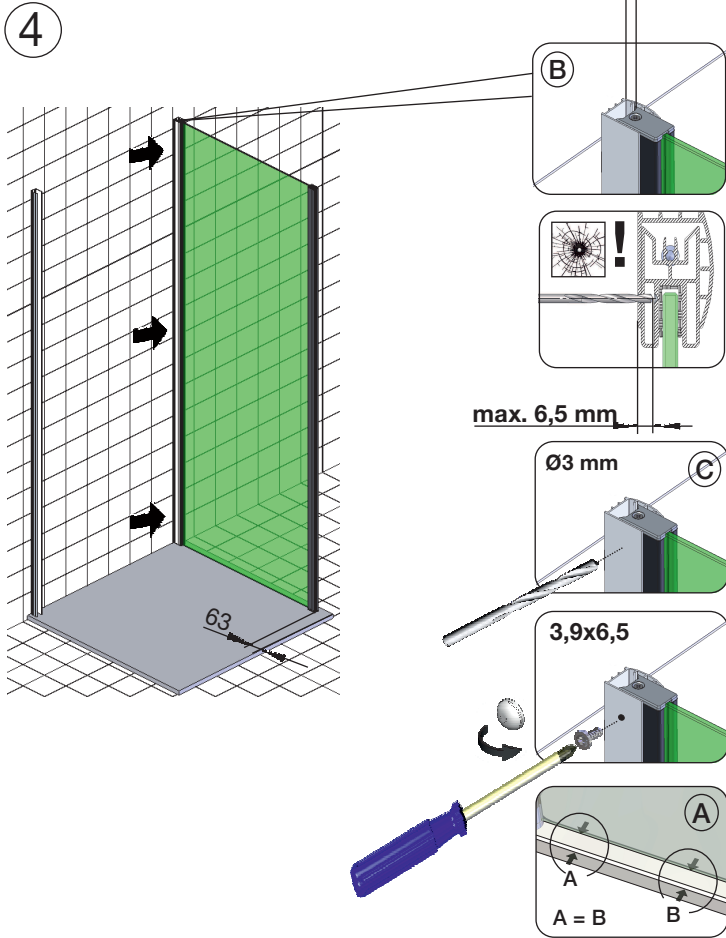

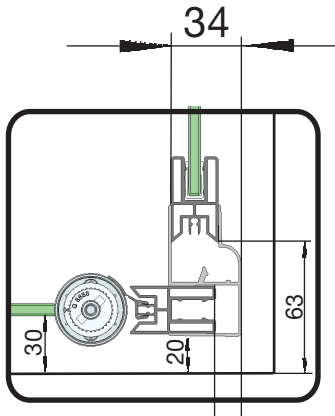
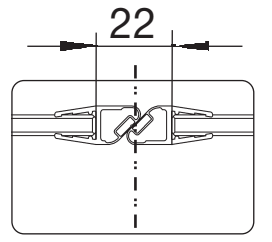
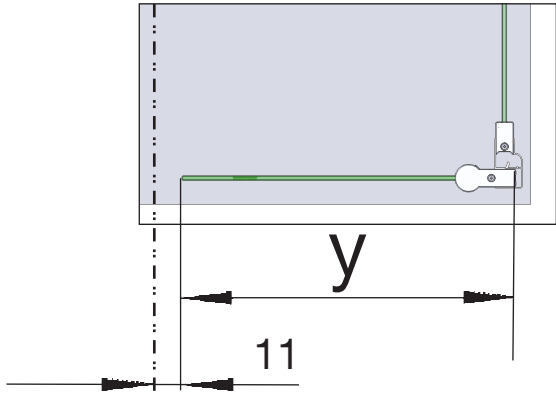
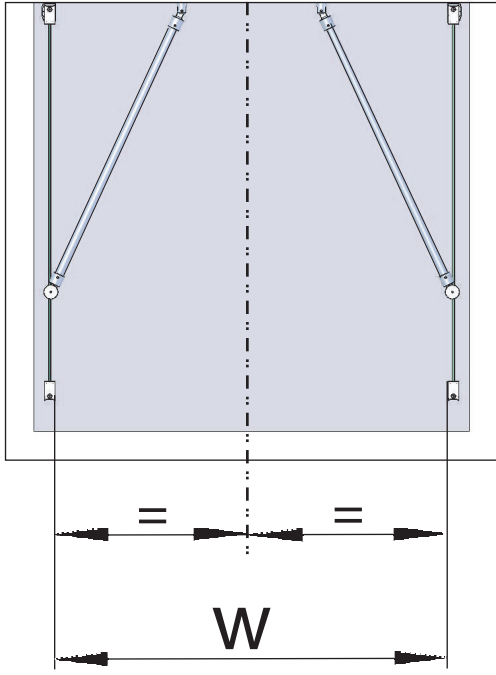

8



	
$y =$	
$\frac{W}{2} =$	

$X =$	
-------	--

$$X = \frac{W}{2} + 34 - 11 - y$$

$X$  Standard = 5,5 mm  
 $X$  max. = 20,0 mm

9

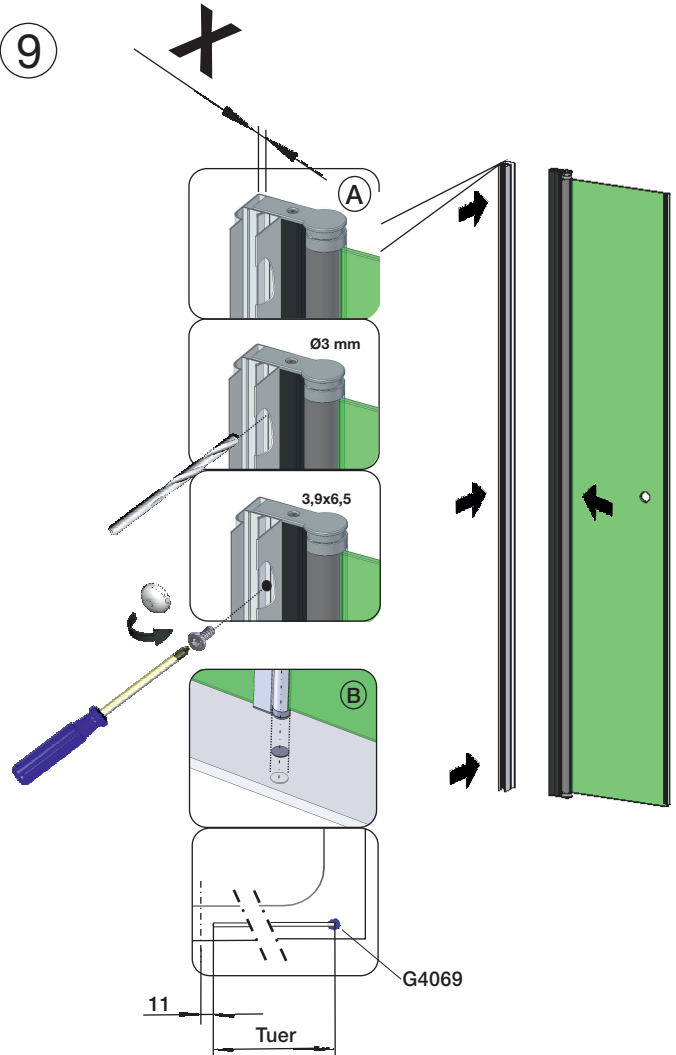

10

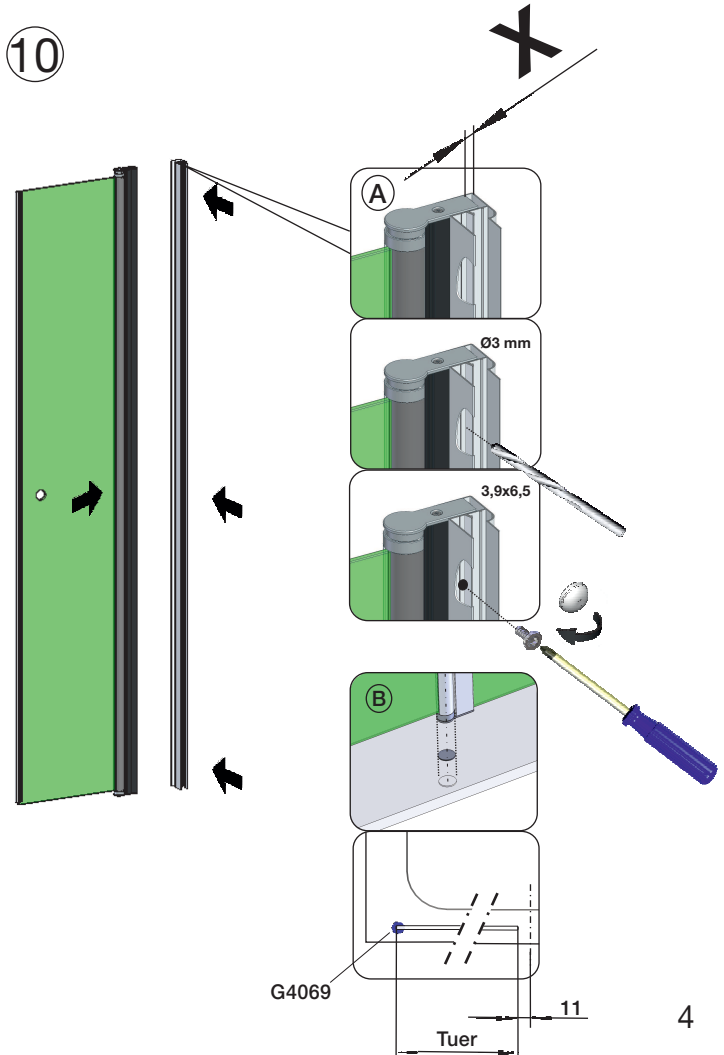

11

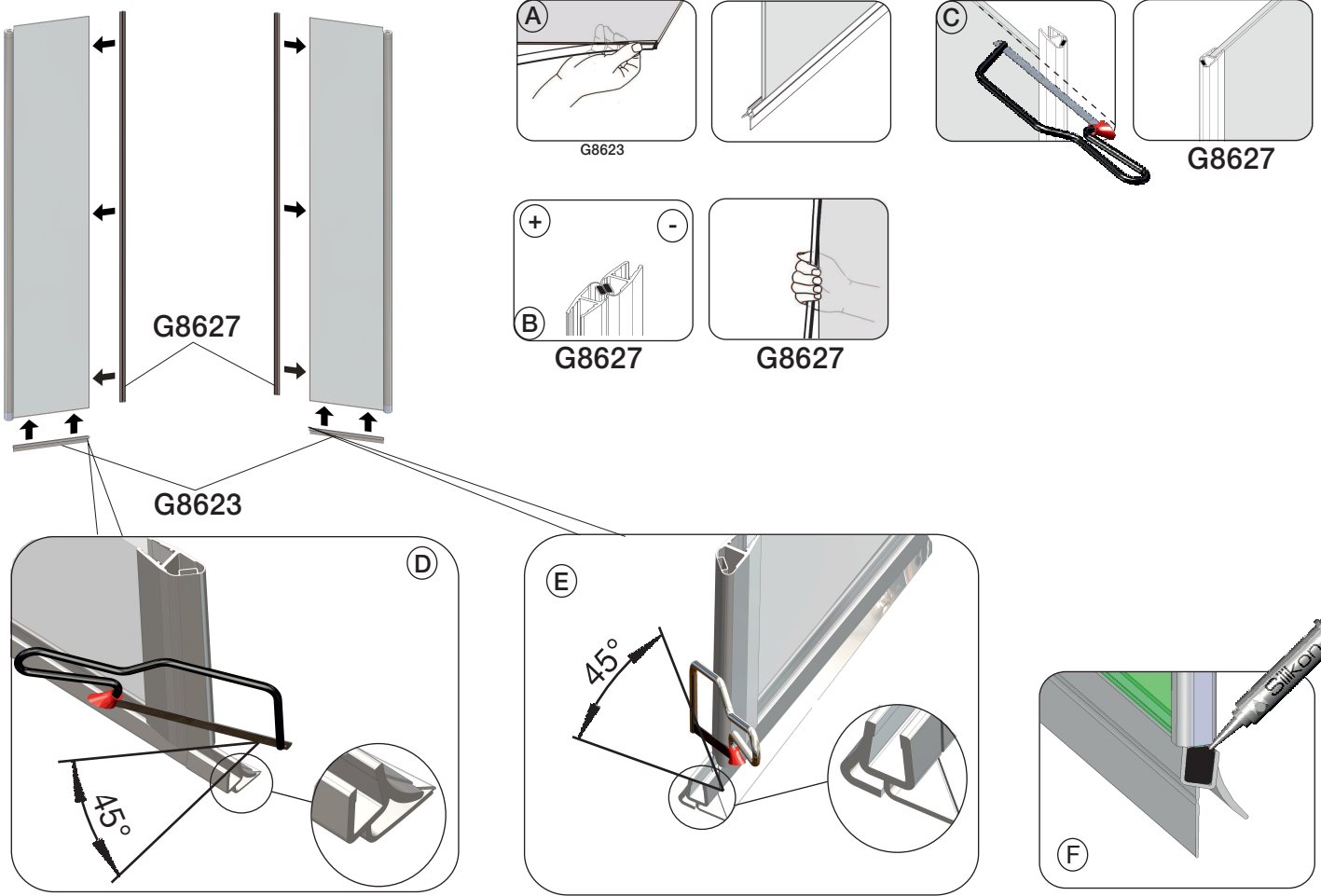

12

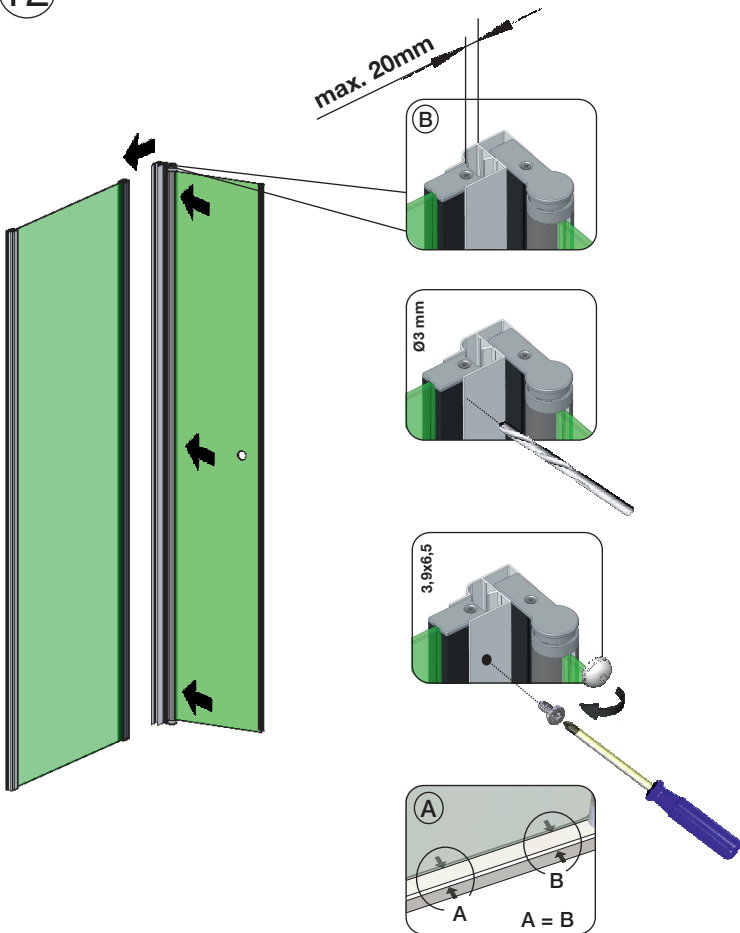

13

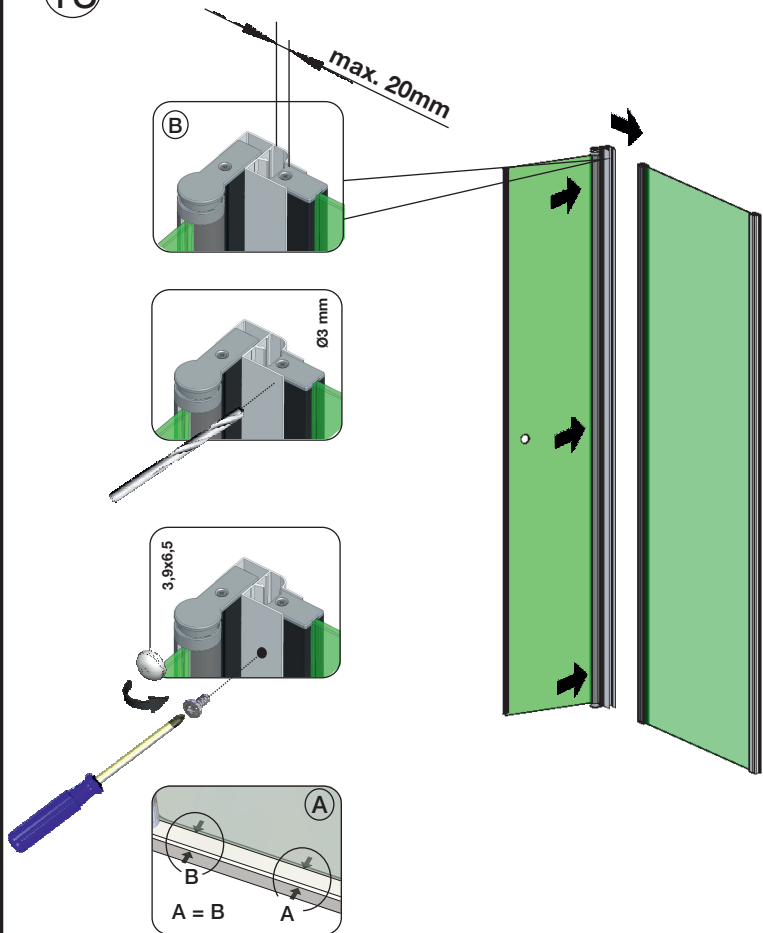

14

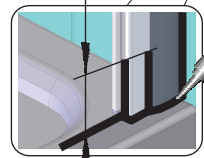
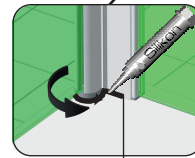
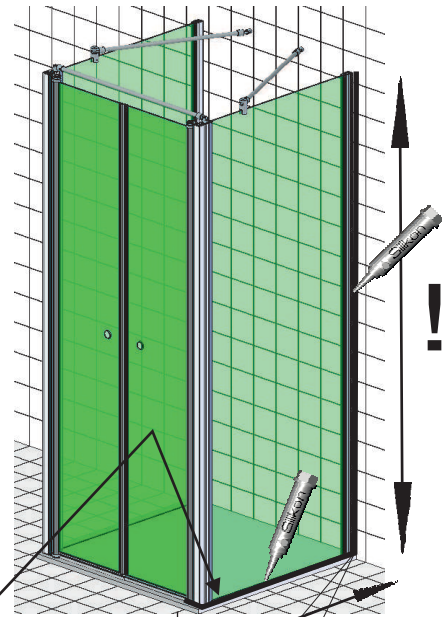

STOP !

15

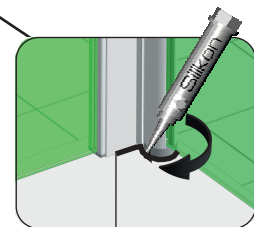
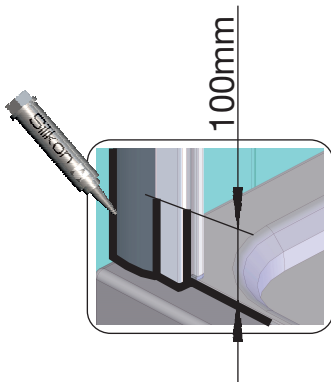
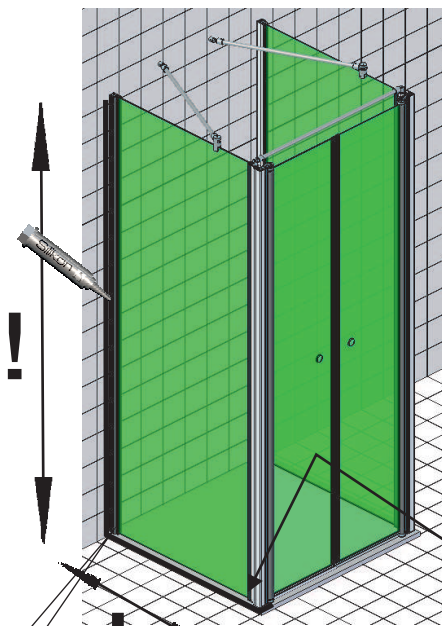

STOP !

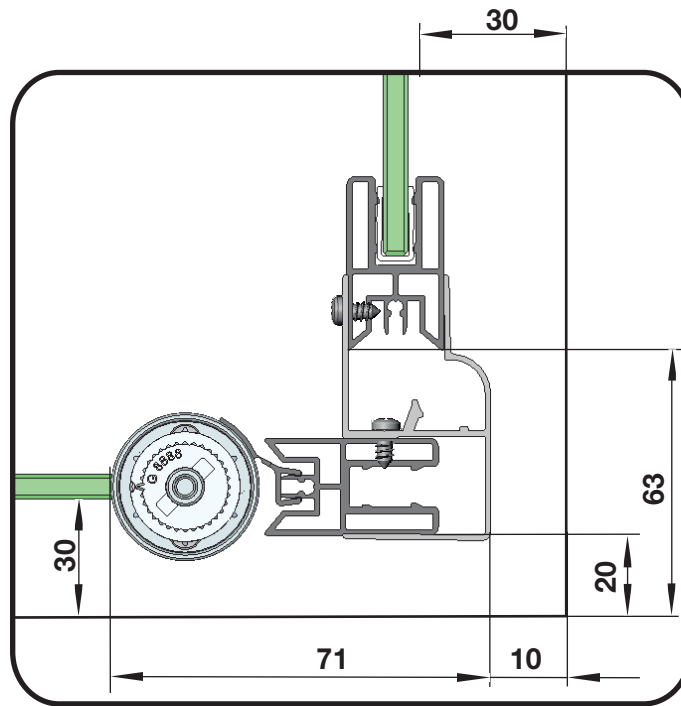

Montage auf Duschtasse

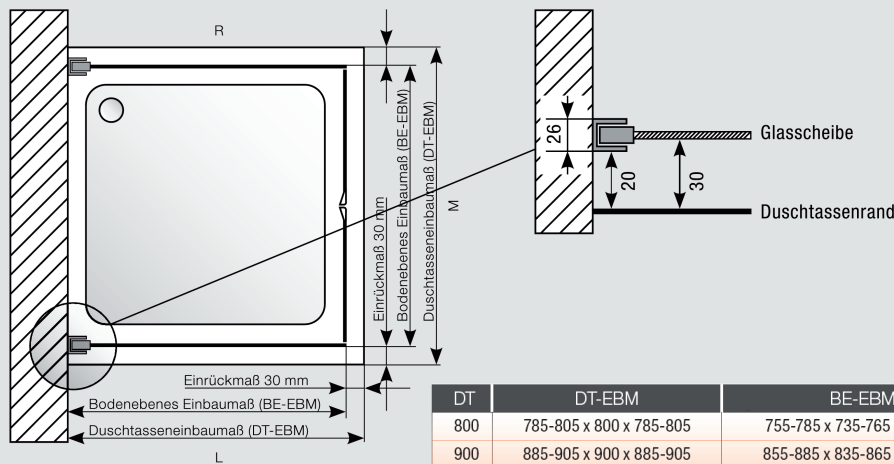

DT	DT-EBM	BE-EBM
800	785-805 x 800 x 785-805	755-785 x 735-765 x 755-785
900	885-905 x 900 x 885-905	855-885 x 835-865 x 855-885
1000	985-1005 x 1000 x 985-1005	955-985 x 935-965 x 955-985

Montage Bodeneben

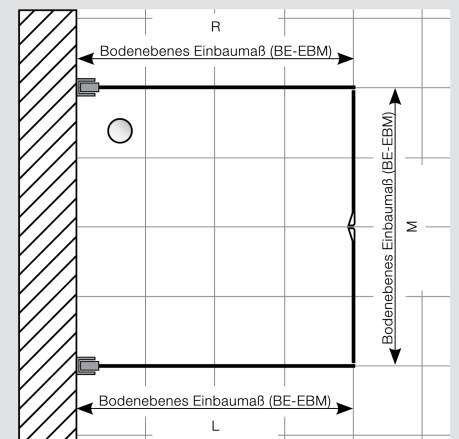

**EG-Konformitätserklärung**  
***EC Declaration of Conformity***

Hersteller/ Name und Adresse: GEO Produkte GmbH  
*Manufacturer/ name and address:* Friedrichsfelder Straße 27  
68723 Schwetzingen

Wir erklären in alleiniger Verantwortung:  
*We declare under our sole responsibility:*

Produktbenennung: Duschabtrennung mit ESG  
oder Kunststoffglas  
*product designation:* shower enclosure with  
tempered glass and acrylic-glass

Typ / Modell: alle Modelle  
*type / model:* all models

stehen in Übereinstimmung mit den Bestimmungen der im Folgenden  
genannten Richtlinie und Standards:  
*are in conformity with the provisions of the following regulations and  
standards:*

**EN 14428:2004 + A1:2008**



GEO Produkte GmbH  
Friedrichsfelder Straße 27  
68723 Schwetzingen /Germany  
Tel. +49(0)6202 20930  
FAX +49(0)6202 209399

13

DE2013/01

[www.geoprodukte.com/service/leistungserklärung.html/](http://www.geoprodukte.com/service/leistungserklärung.html/)

EN 14428

**Duschabtrennung** mit Einscheiben Sicherheitsglas oder Kunststoffglas  
**Shower wall** made of *ESG tempered safety glass or sythetic glass*

Reinigbarkeit:  
*cleanability:* Bestanden  
*passed*

Bruch Eigenschaften:  
*impact resistance:* Bestanden  
*passed*

Dauerhaftigkeit:  
*durability:* Bestanden  
*passed*