

ART.NR.
5419 1309
9615 3758
6201 8036
9737 5405

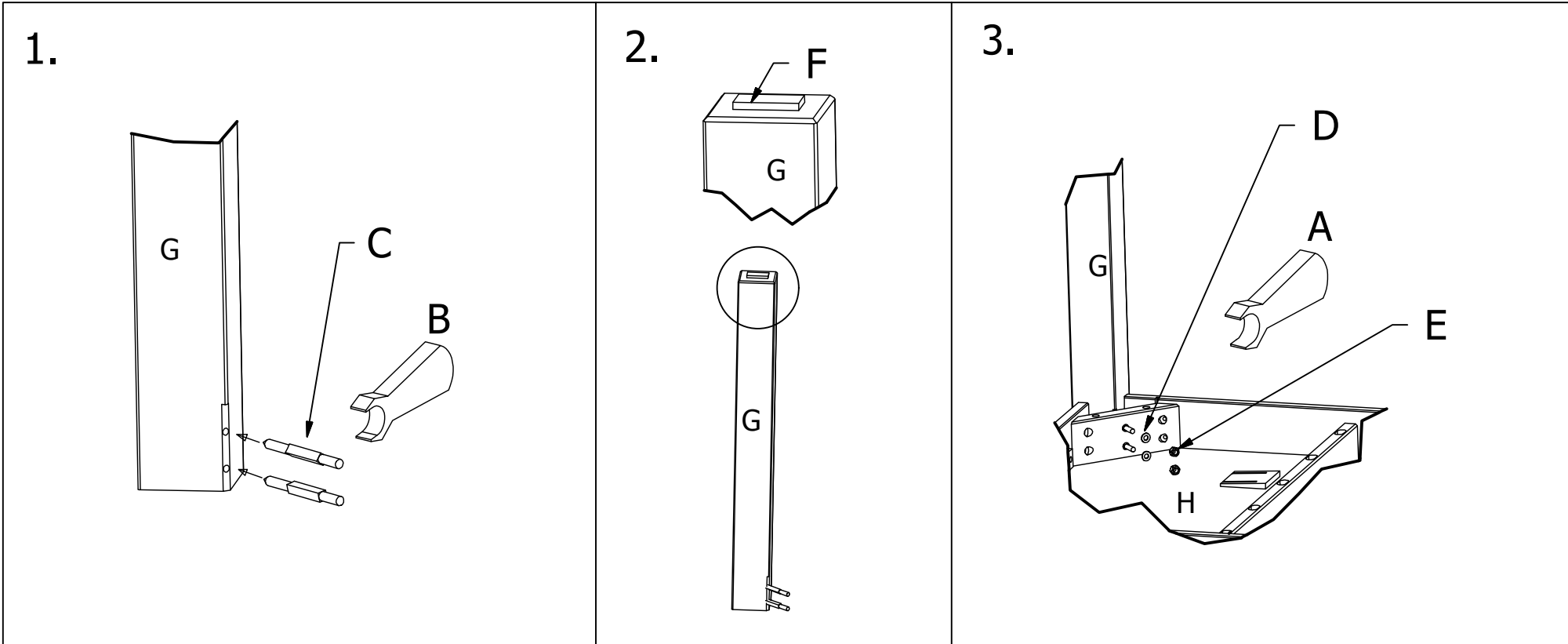

30 min

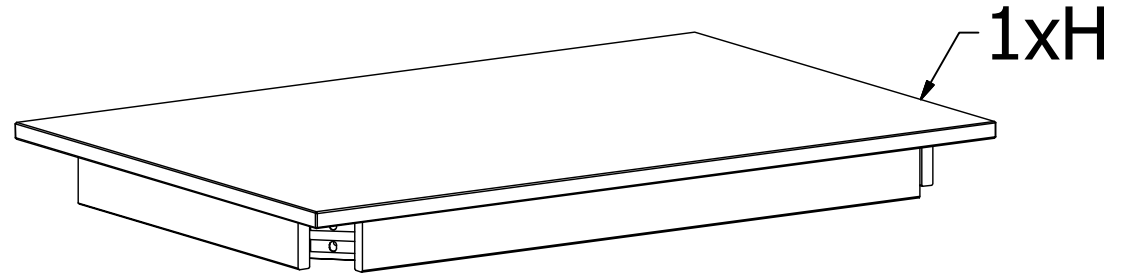
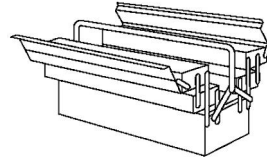
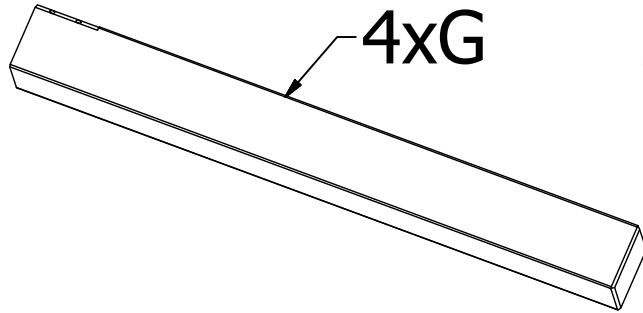
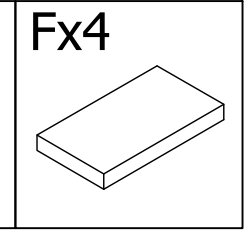
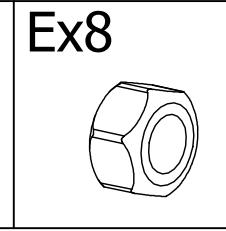
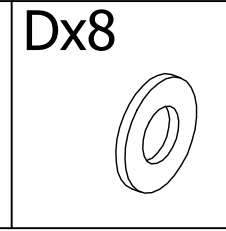
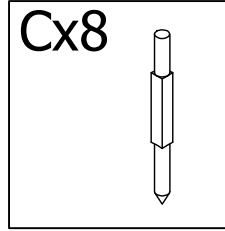
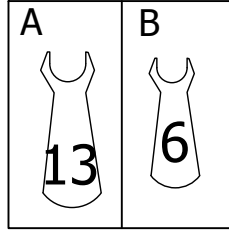
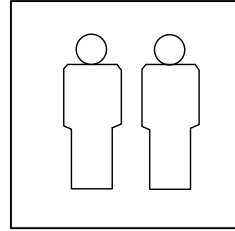

Service • Assistenza • Dienstverlening • Serwis

Сервис • Servis • Сервисная служба

Name • Nom • Nome • Naam •
Nazwa • Imięno • Назов • Név •
Denumire • Iem • Название

Nr. • No. • N° • Номер • Č. • Sz.

5419 1309, 9615 3758, 6201 8036, 9737 5405

Typ • Type • Тип

Tipus • Tipo • Тип

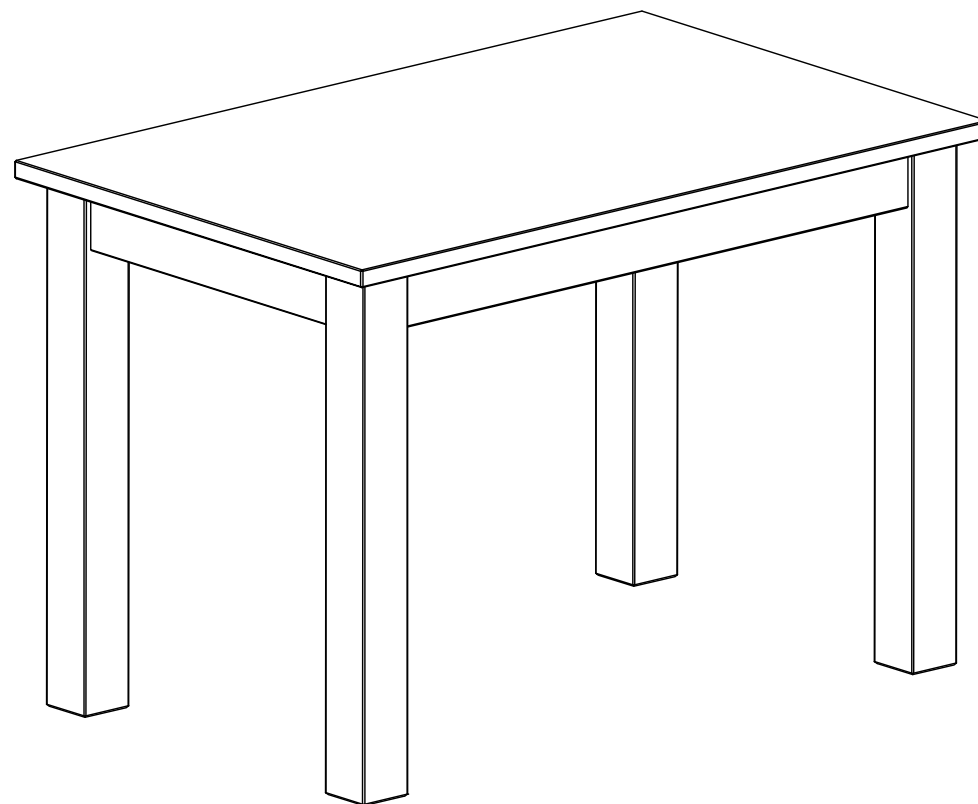
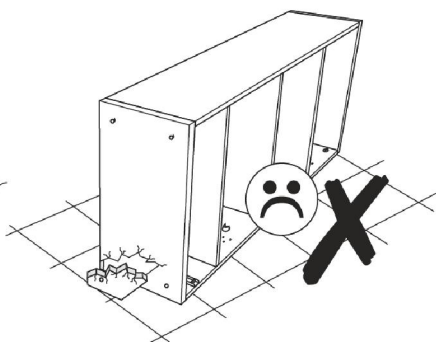
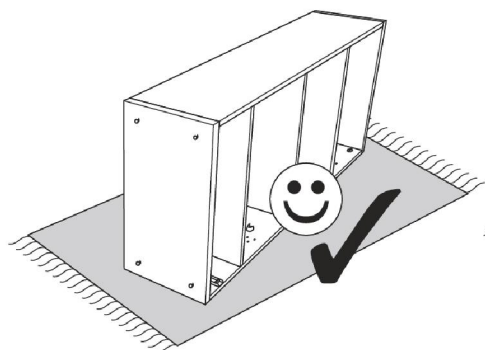
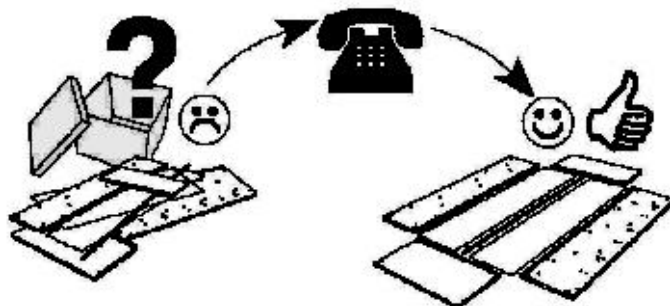
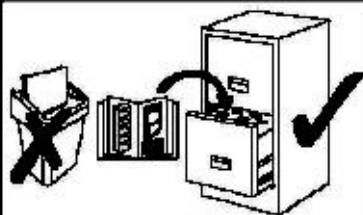

- D** Montageanleitung
- FR** Notice de montage
- NL** Handleiding voor de montage
- CZ** Montážní návod
- HU** Szerelési útmutató
- TR** Montaj talimatı

- GB** Assembly instructions
- IT** Istruzioni di montaggio
- PL** Instrukcja montażu
- SK** Návod na montáž
- RO** Instrucțiuni de montaj
- RU** Инструкция по монтажу
- HR** Shema montaže

0 10 20 30 40 50 60 70 80 90 100 110 120 130 140 150 160 170 180 190 200

