

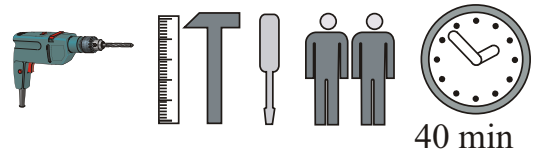

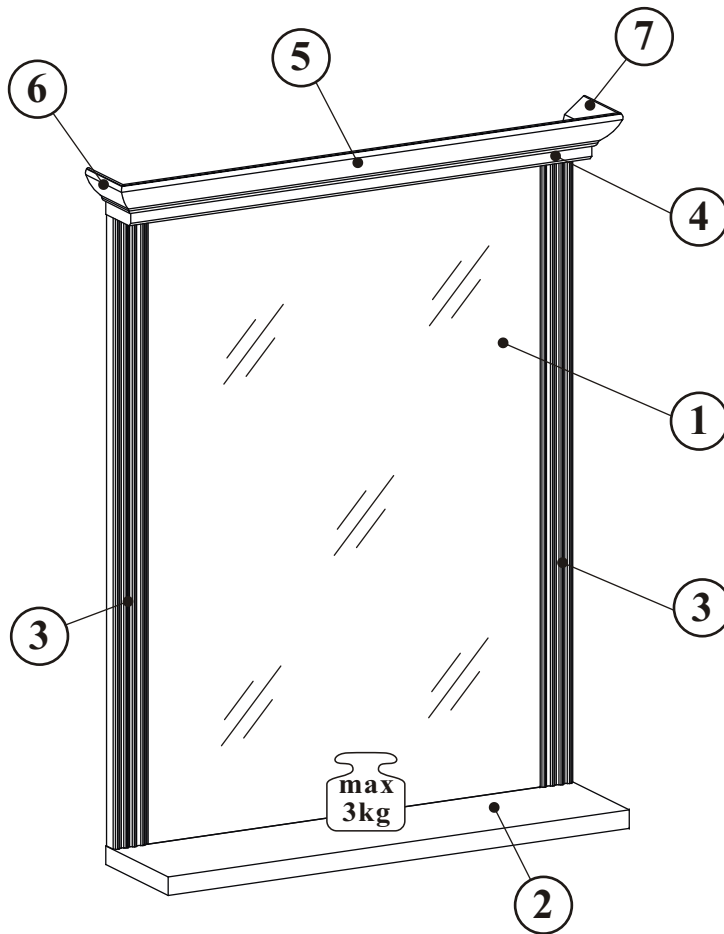

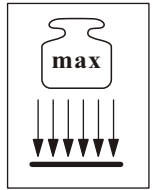



# JASMIN 30B1\_50

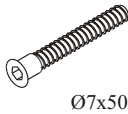

NO	Dim.			Col.-No	Qty
1	750	512	16	1	1
2	600	150	22	1	1
3	750	43	19	1	2
4	600	60	16	1	1
5	653	67	22	1	1
6	86	67	22	1	1
7	86	67	22	1	1

A1 x6  ø8x36	A3 x4  ø8x47	B5 x12  ø15x12	G5 x12 	B9 x6  ø7x48	D9 x7  USØ3x20
B11 x6  ø7x50	G4 x6 	D28 x6  ESØ6x9,5	KR2 x3 	G2 x1 	

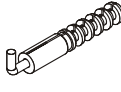
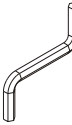
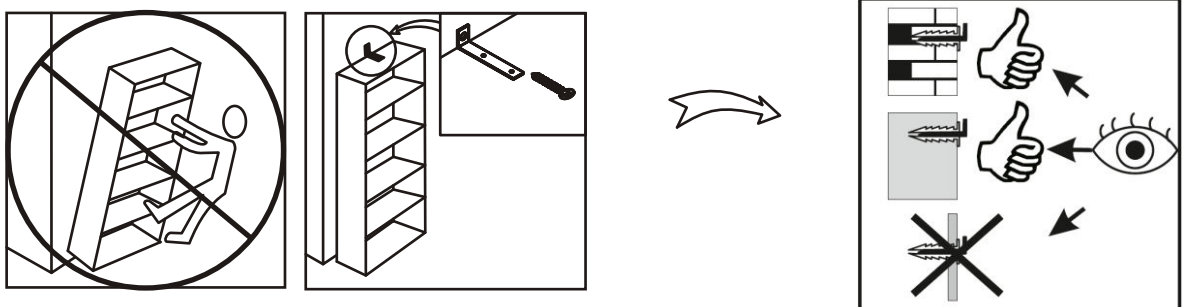
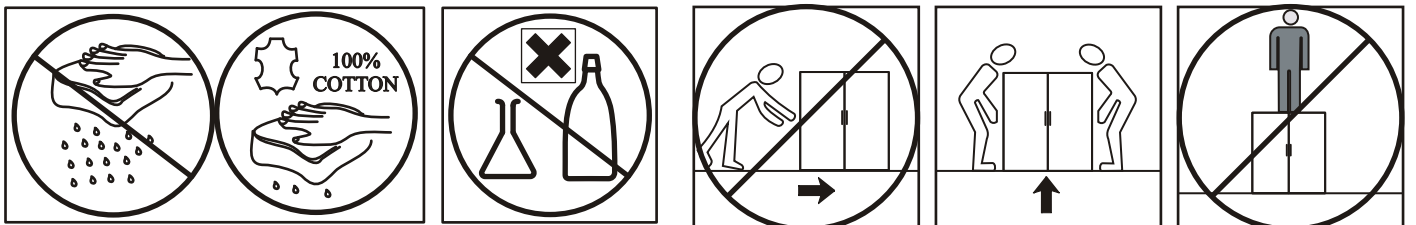
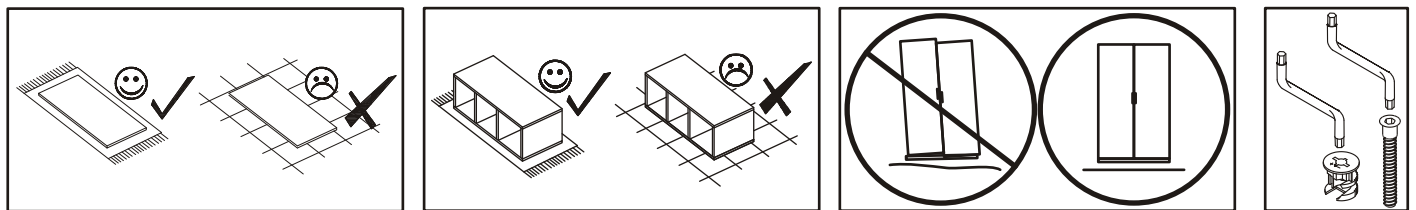
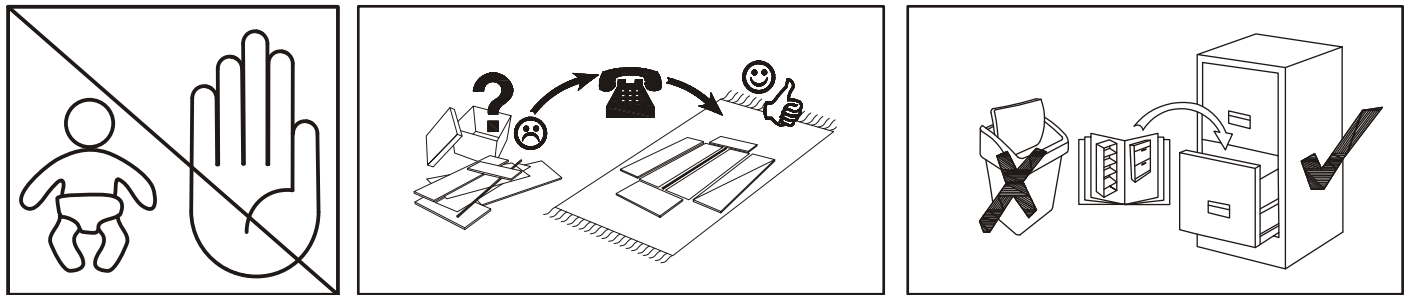
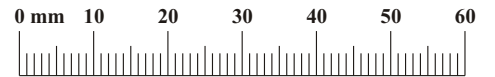

1

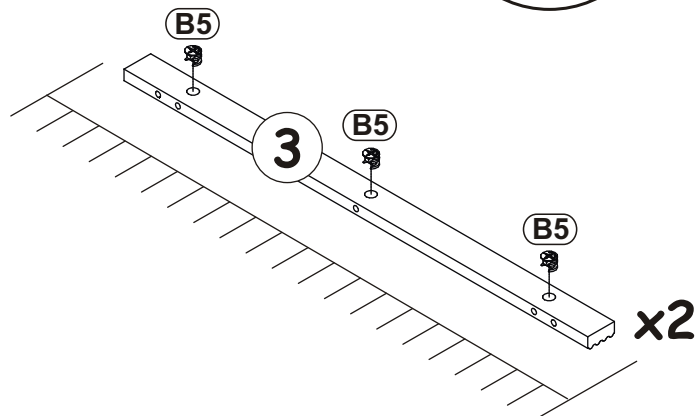
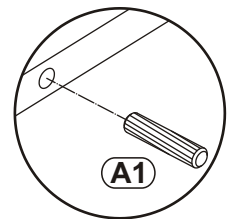
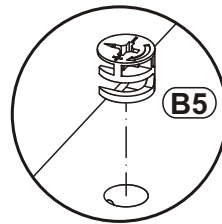
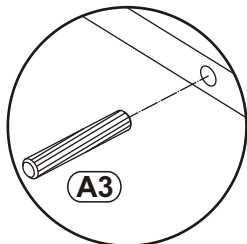
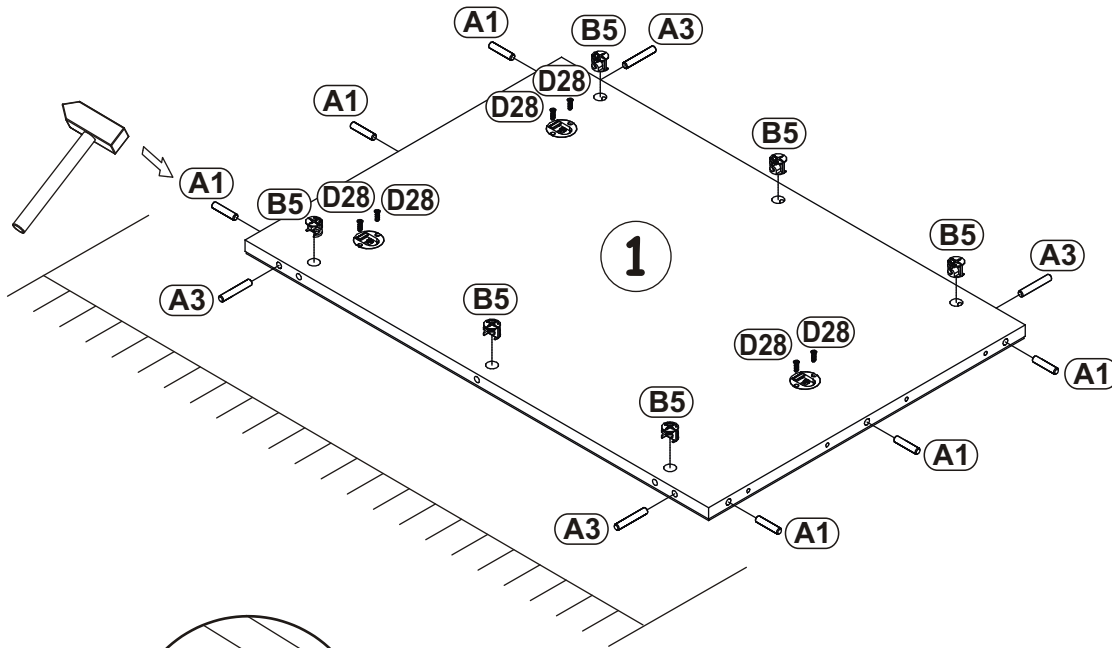
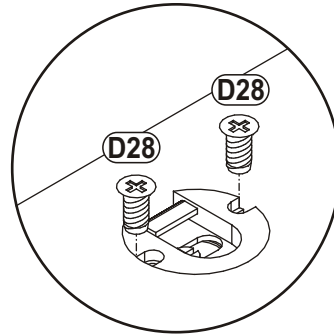
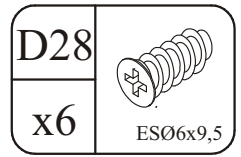
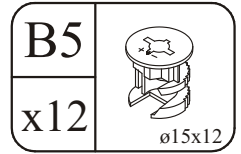
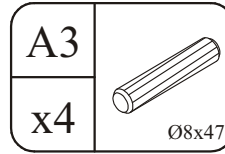
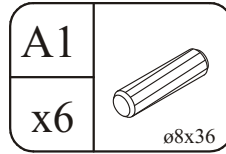
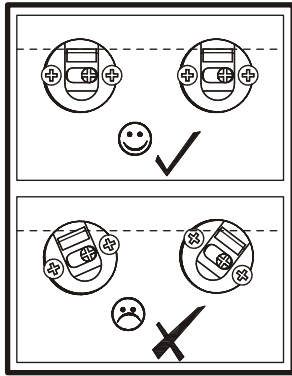

B9		G5	
x6	Ø7x48	x12	

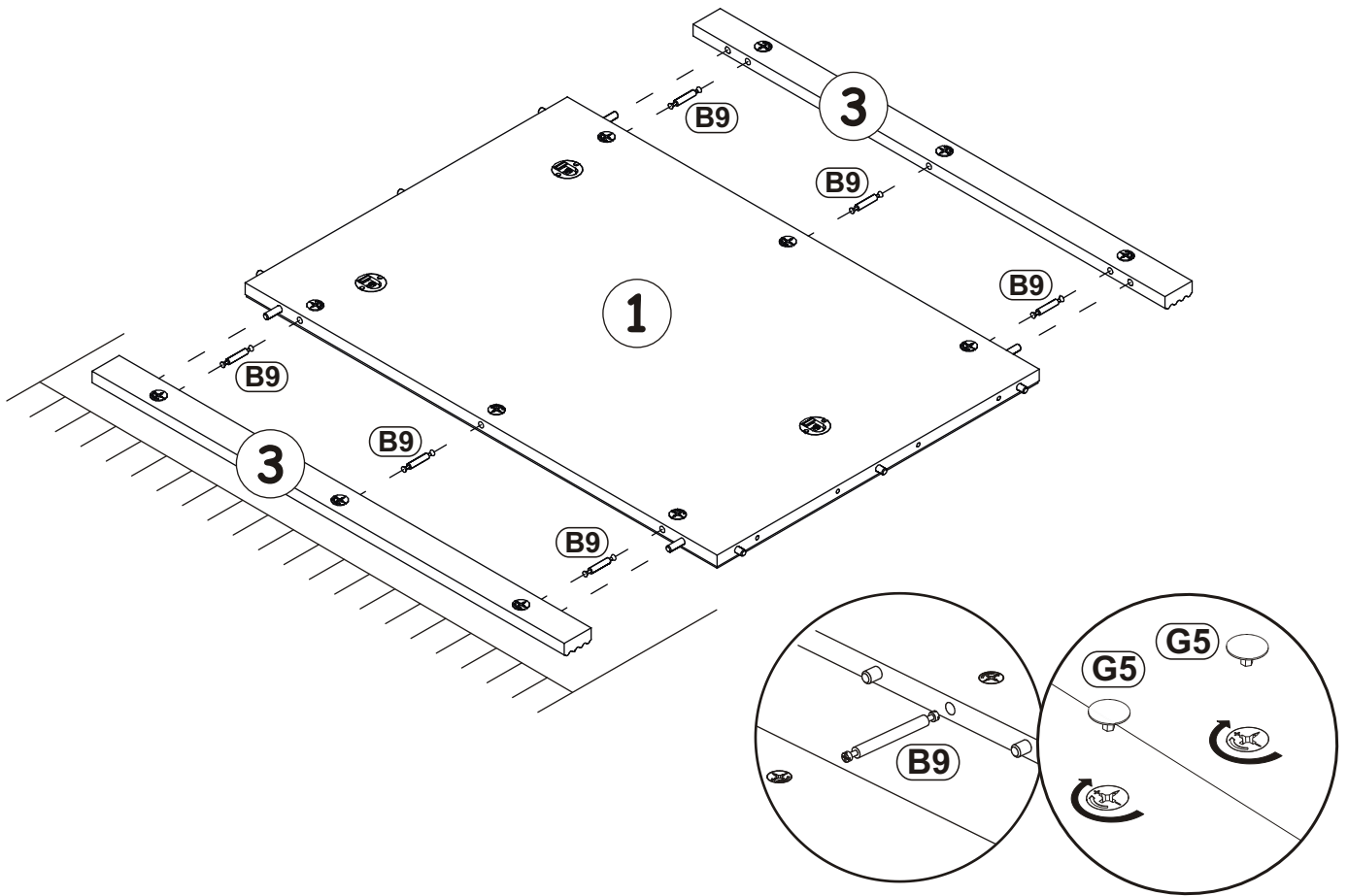

2

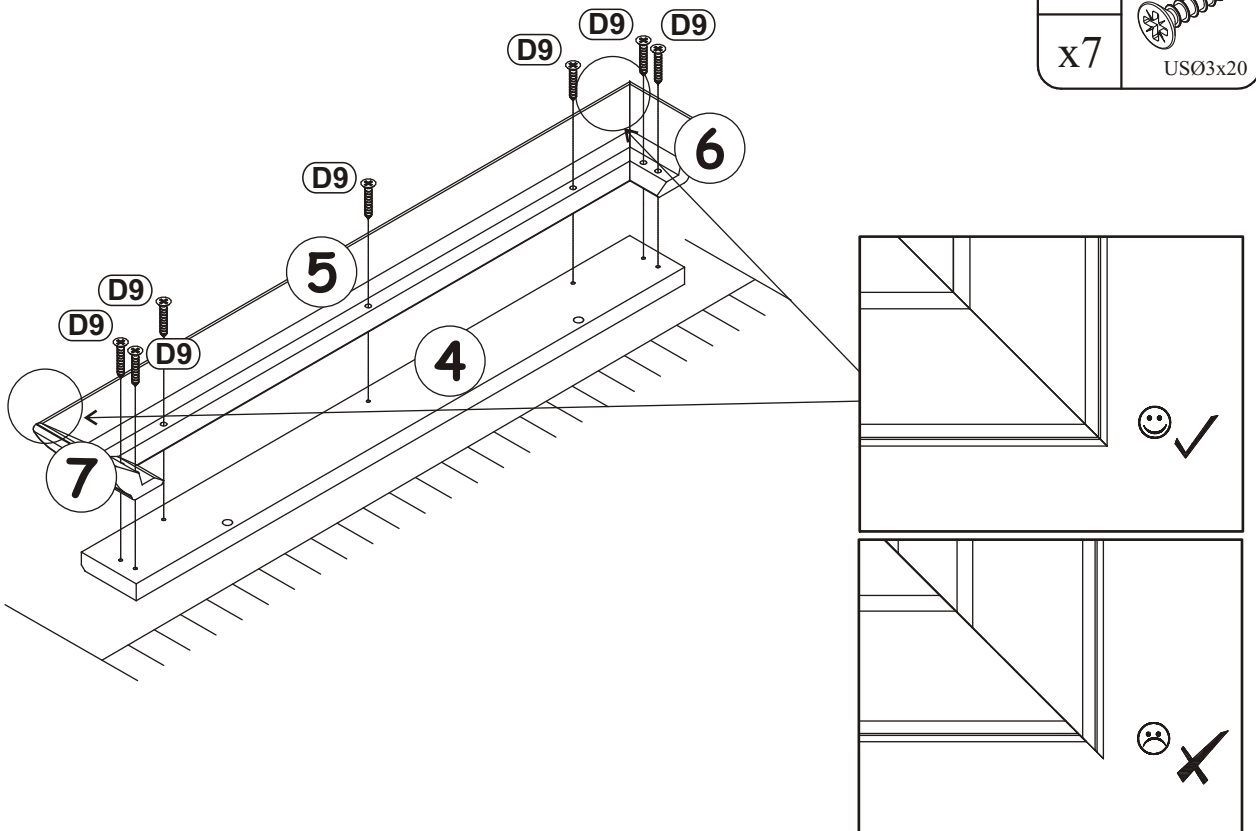

3

D9	
x7	USØ3x20



B11		G4	
x6	Ø7x50	x6	

4

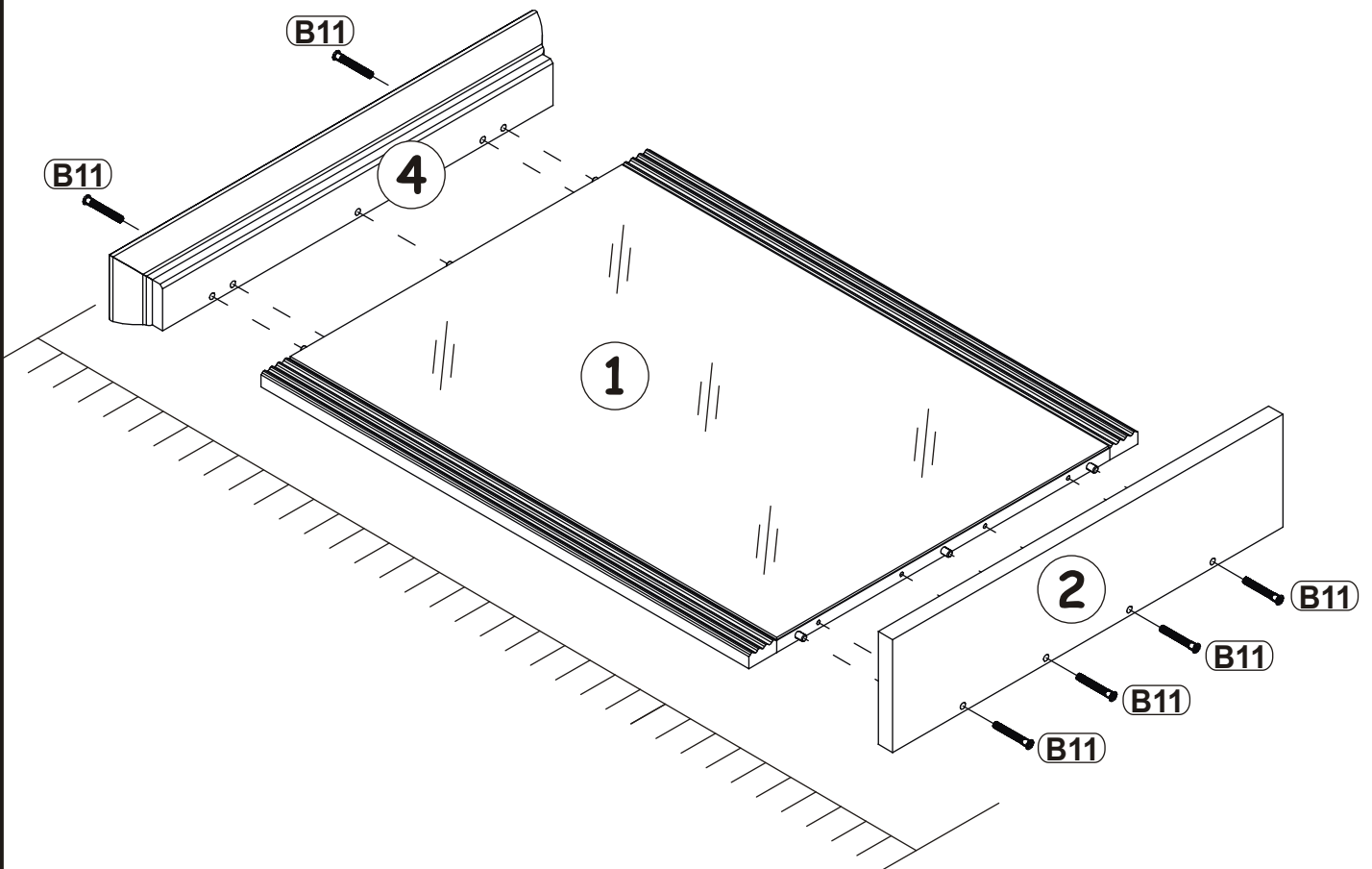
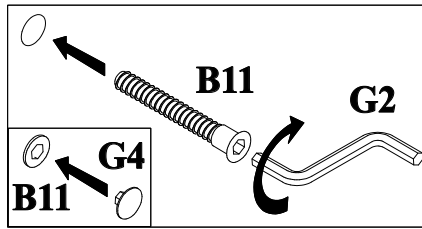

KR2  
x3

5

