

# Bengo

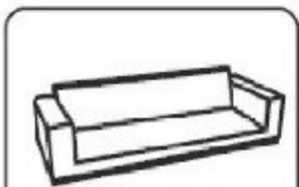

- |                                  |                               |
|----------------------------------|-------------------------------|
| (D) Montageanleitung             | (GB) Assembly instructions    |
| (FR) Notice de montage           | (IT) Istruzioni di montaggio  |
| (NL) Handleiding voor de montage | (PL) Instrukcja montażu       |
| (CZ) Montážní návod              | (SK) Návod na montáž          |
| (HU) Szerelési útmutató          | (RO) Instrucțiunile de montaj |
| (TR) Montaj talimatı             | (RU) ИНСТРУКЦИЯ ПО МОНТАЖУ    |

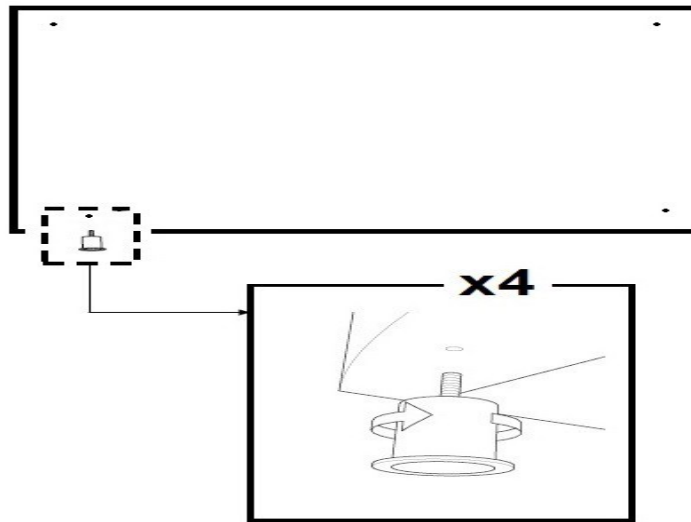
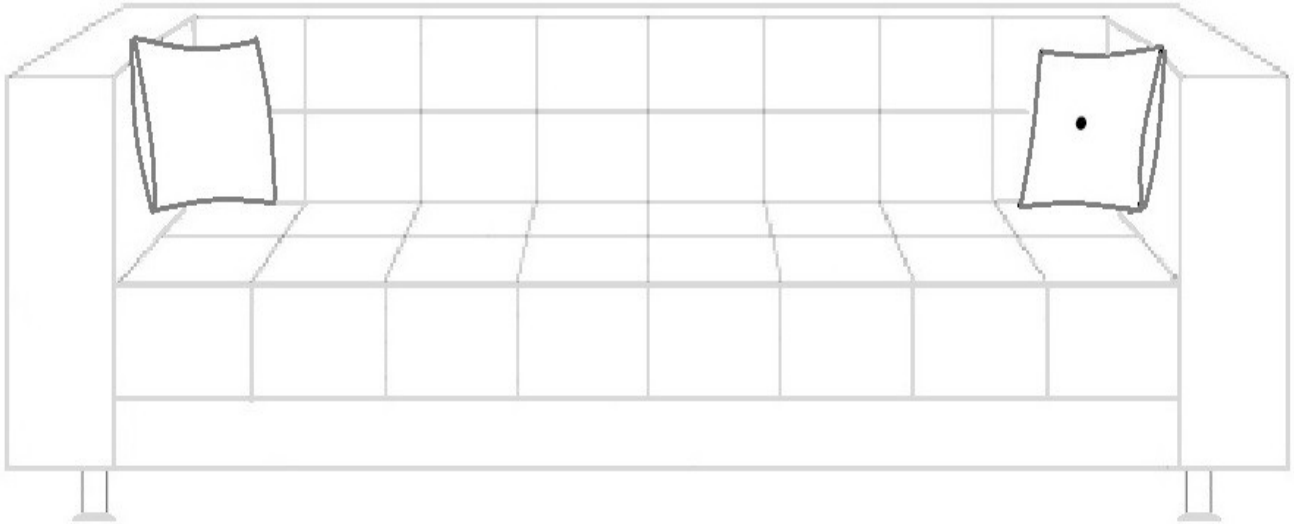

Ax1



Bx4

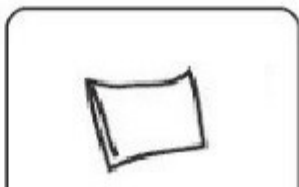

Cx1

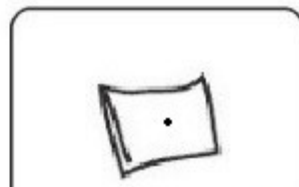

Dx1

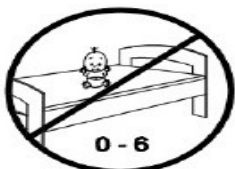

0-6



Service · Assistenza · Dienstverlening · Serwis  
 Servis · Szerviz · Сервисная служба

Name · Nom · Nome · Naam ·  
 Nazwa · Jméno · Názov · Nev ·  
 Denimire · Isim · Название ·

Bengo

Nr. · No. · № · Номер · Č · Sz ·

Typ · Type · Tip · Típus · Тиро ·  
 Тип

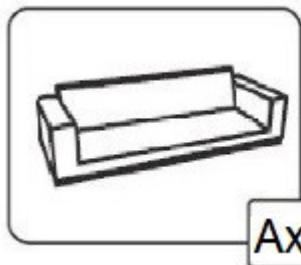
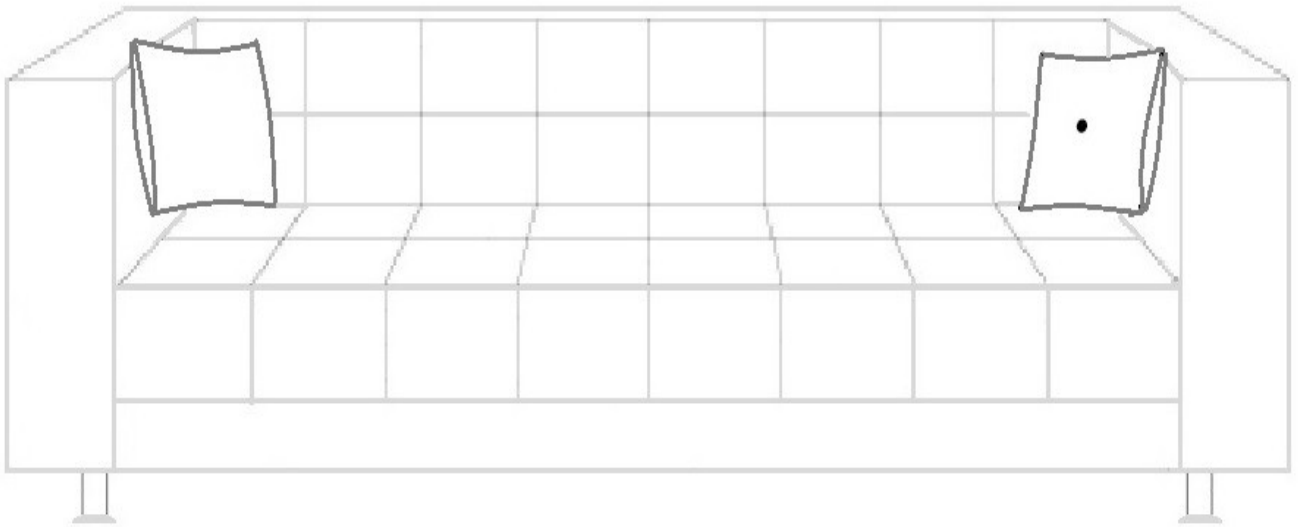
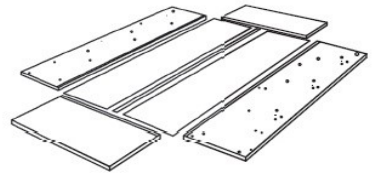
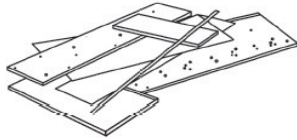
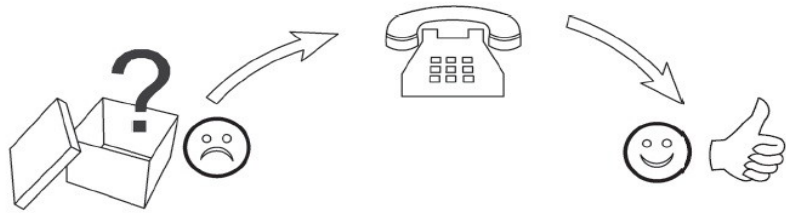
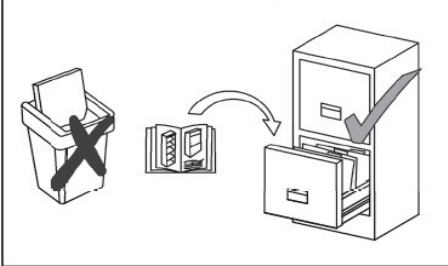

Ax1

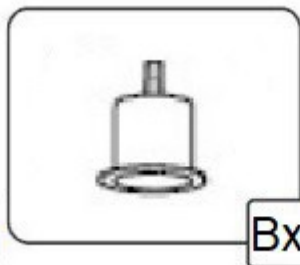

Bx4

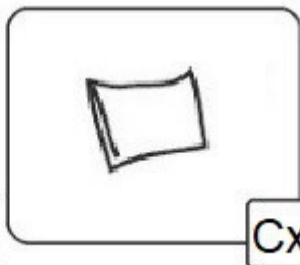

Cx1

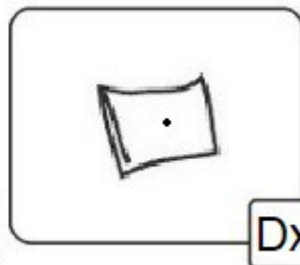

Dx1

