

Stacey



D Montageanleitung

GB Assembly instructions

FR Notice de montage

NL Handleiding voor de montage

CZ Montážní návod

IT Istruzioni di montaggio

RO Instrucțiuni de montaj

RU инструкция по сборке

PL Instrukcja montażu

SK Návod na montáž

HU Szerelési útmutató

TR Montaj talimati

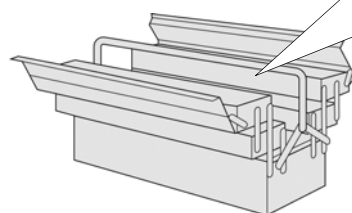
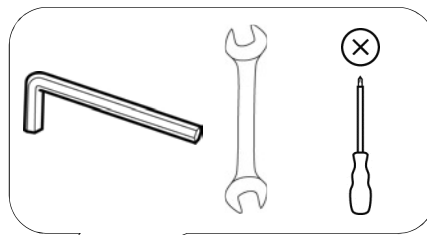
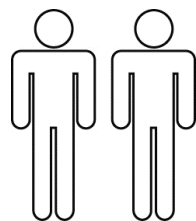

Bei der Montage Kopfteilbrett unbedingt beachten !

**Bettkasten
Außenseite**

**Teil 4
Bettseite-
Innen**

Kopfteilbrett vor der Montage

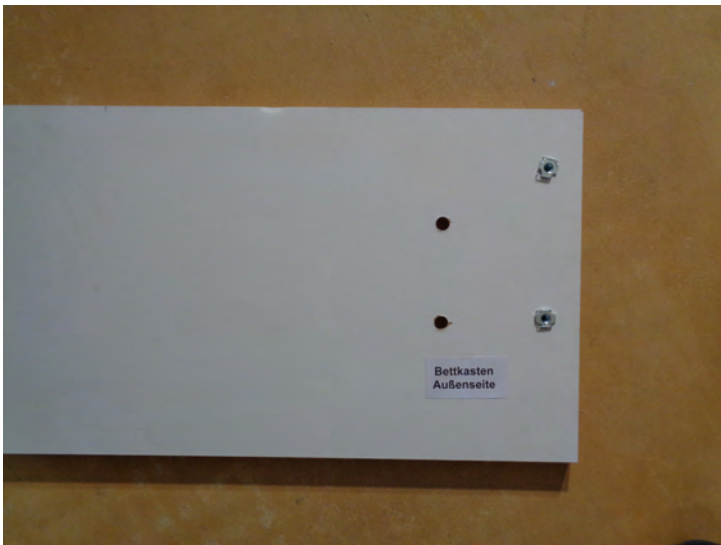

Kopfteilbrett nach der Montage



0
10
20
30
40
50
60
70
80
90
100
110
120
130
140
150
160
170
180
190
200

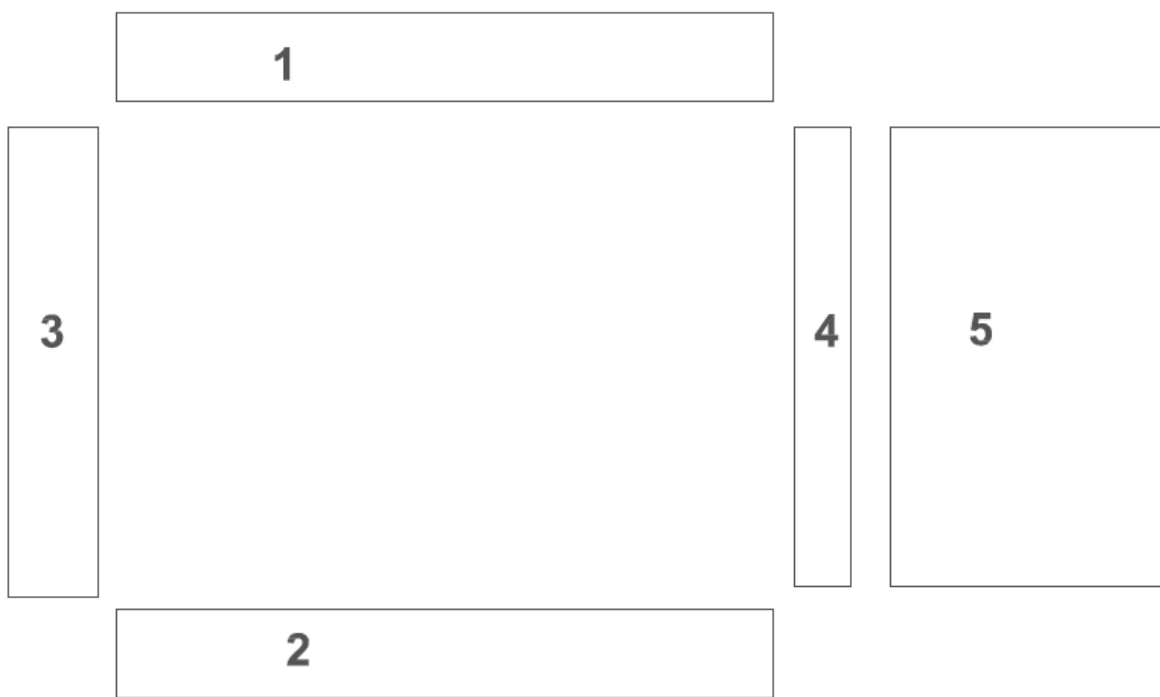

Service • Assistenza • Dienstverlening • Serwis Servis • Szerviz • Сервисная служба	
Name • Nom • Nome • Naam Nazwa • Jméno • Názov • Név Denumire • İsim • Название	Stacey EB
Nr. • No. • N° • Номер • Č • Sz	SH40-47
Typ • Type • Tip • Típus • Tipo Тип	BK zerl.

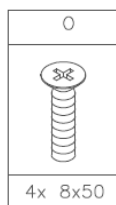

A	B	C	D	E	H	J	K	L	M
4x	16x 3,5x20	4x	16x 6x25	4x	4x 8x20	4x	4x 6x35	4x M6	4x M6



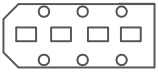

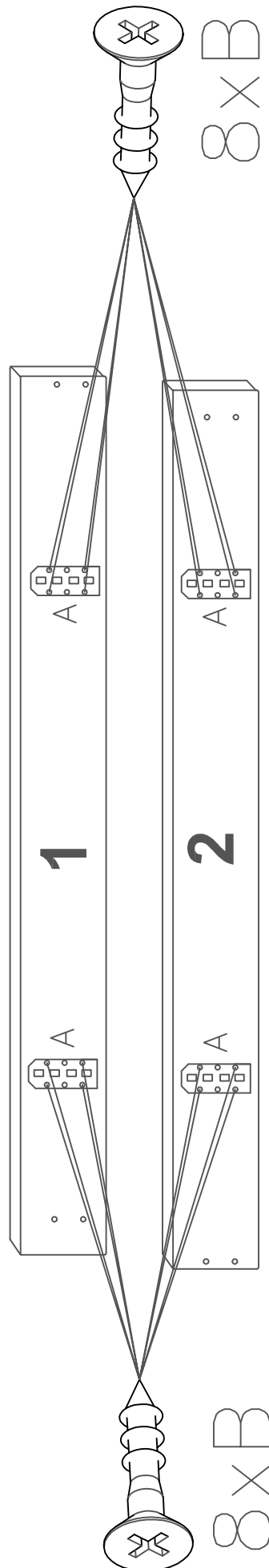

A		4x
B		16x 3,5x20







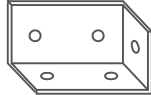

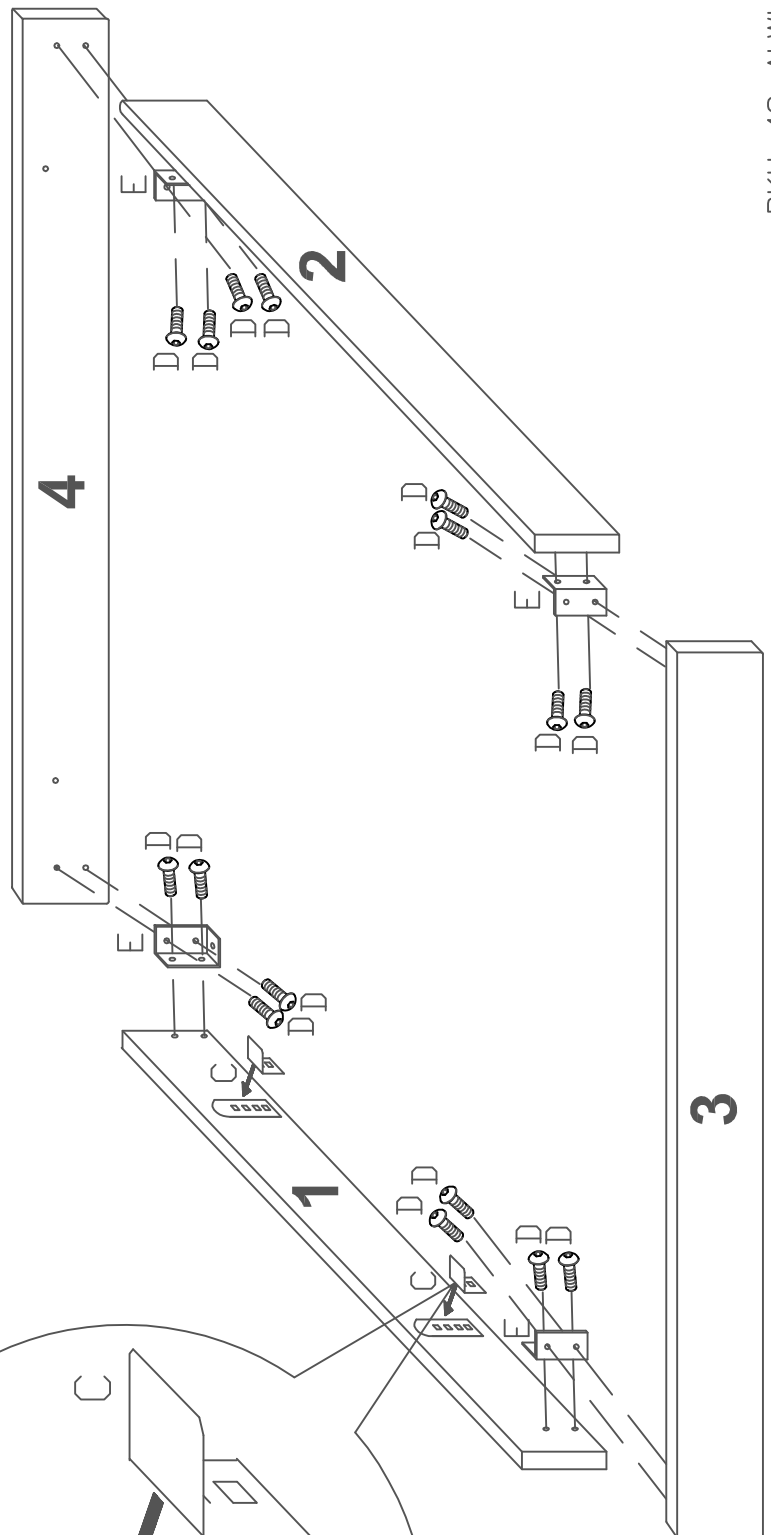
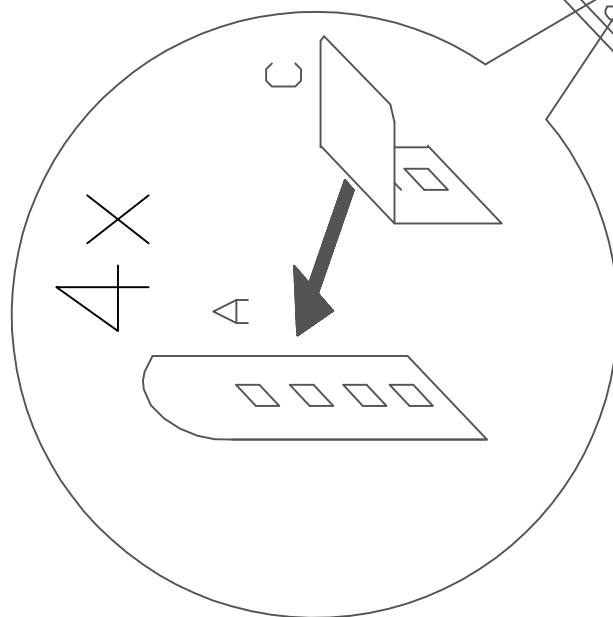
BKU-4S-4x-ALP-LS

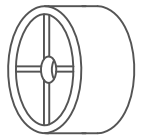

C		8x 4,5x20
D		8x 6x50
E		16x 6x25



3.

		Ausführung mit Kunststofffuß	
J		M	
	4x		4x M6
K		L	
	4x 6x35		4x M6
H		H	
	2x 8x20		2x 8x20

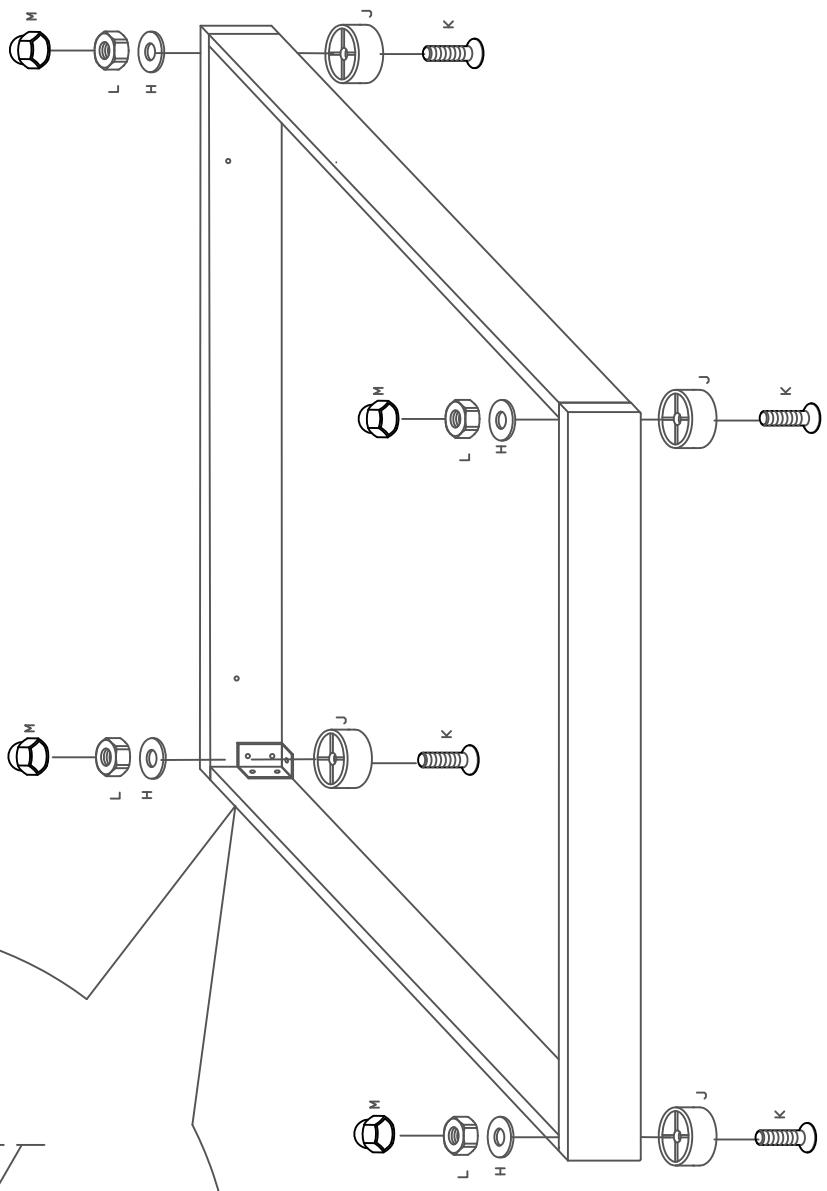
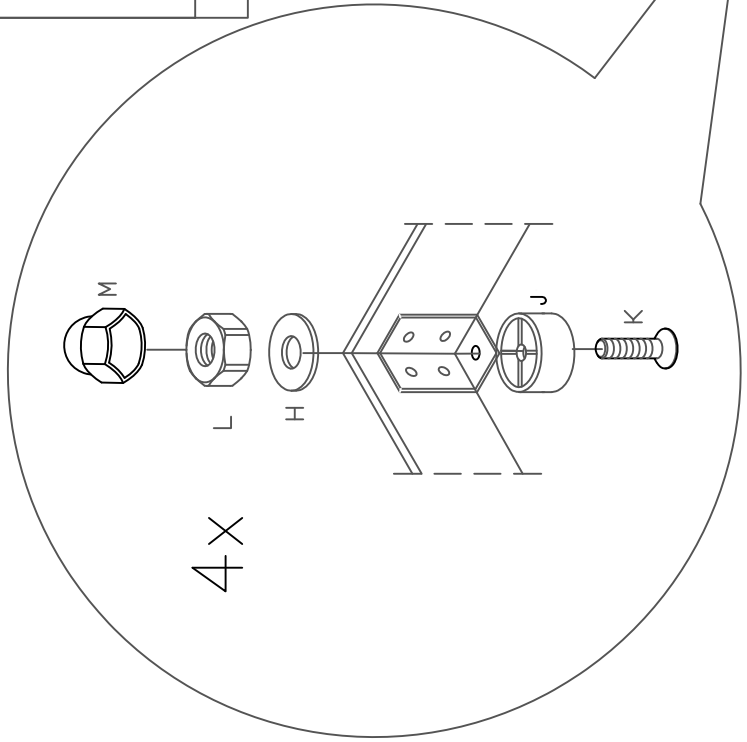

4.

Kopfteil zum Schluß montieren

