

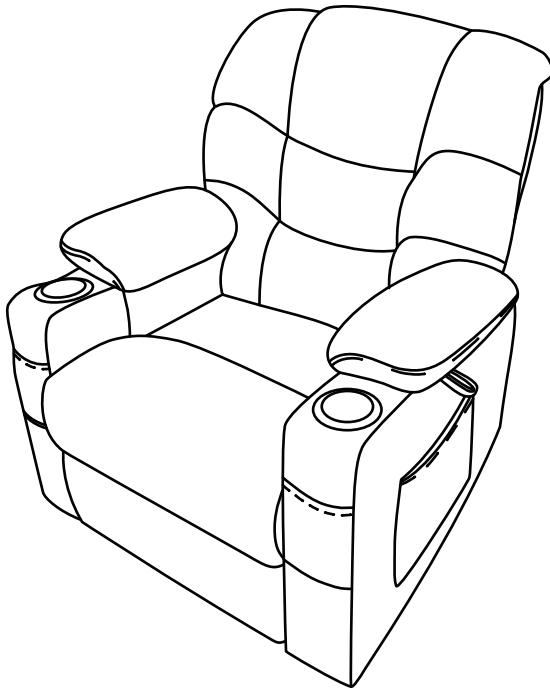

**MCombo**





## **Sofa assembly instruction**

(English / Deutsch / Français / Español / Italiano)

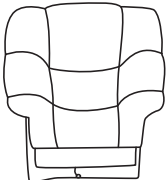
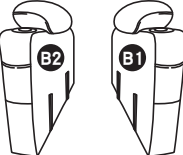
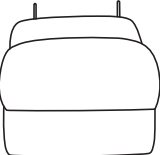

**Pfillo GmbH**

6160-7550

<p><b>A</b></p>  <p>Backrest 1X</p>	<p><b>B</b></p>  <p>left and right armrest 2X</p>	<p><b>C</b></p>  <p>Chair base 1X</p>	<p><b>D</b></p>  <p>Remote control 1X</p>	<p><b>F</b></p>  <p>Parts 2X</p>
			<p><b>E</b></p>  <p>Power Source 1X</p>	<p><b>G</b></p>  <p>Parts 4X</p>

## STEP 1

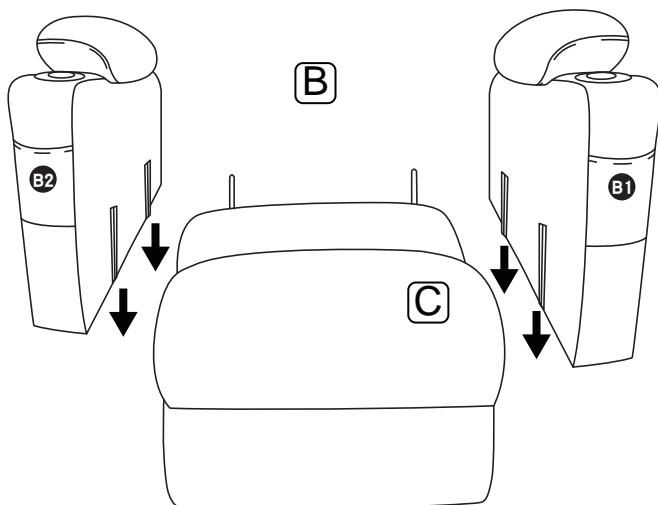

## STEP 2

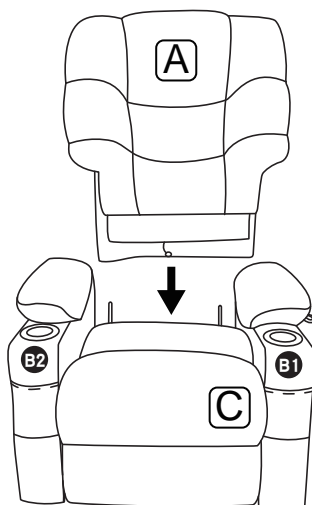

## STEP 3

- Connect cable ① and 1 of the same color from the backrest and cushions.
- Connect the USB cable to the interface ② on the seat base.
- Connect remote control **D** with the interface ③ from the seat base.
- Connect power supply **E** to the interface ④ from the seat base.

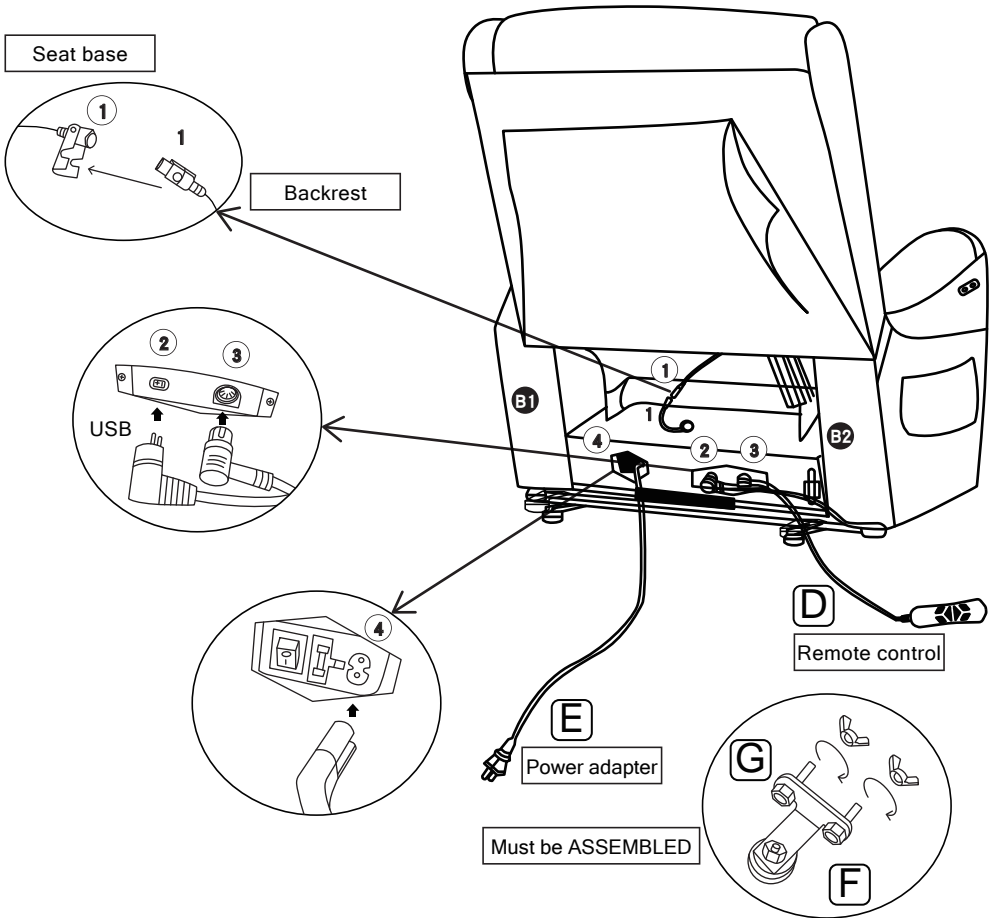

### NOTE :

The USB port is installed on the bottom of the armrest of the sofa.  
 The motor cable is wrapped around the push rod behind the seat base.

## How to recline ?

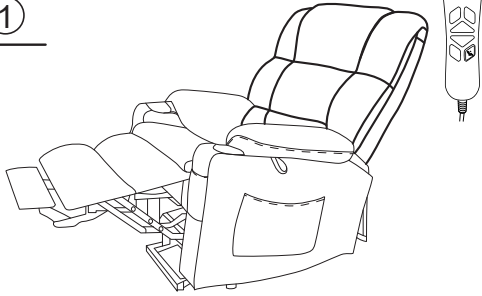
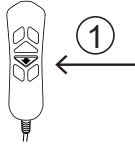
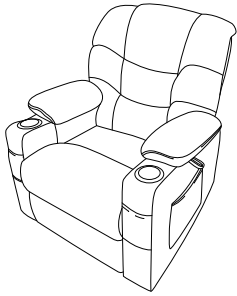

1. press the button ① can recline the footrest continuously.
2. Press the button ②, the backrest can be tilted further up to 170 degrees.



## How do you snap the footrest into place and stand ?

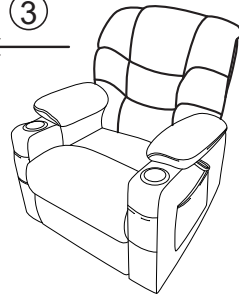
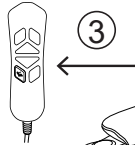
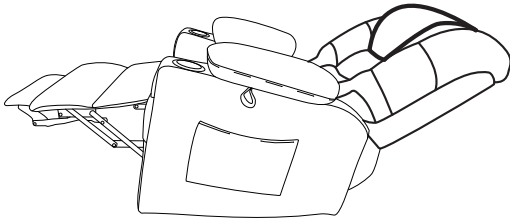



3. Press the button ③ can return the backrest to its original position.
4. Press the button ④ to return the footrest to its original position. Keep this button pressed, the chair can recline forward.



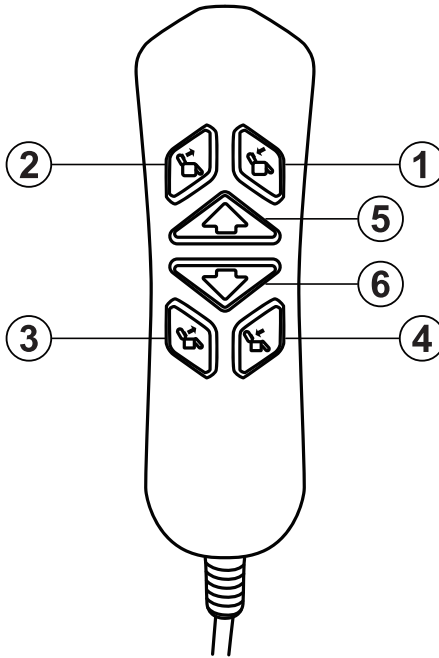

## How to use the remote control ?





### Height adjustment for the headrest

- ①  Press the button to adjust the headrest downward.
- ②  Press the button to adjust the headrest upwards.







### Height adjustment for the backrest

- ③  Press the button to adjust the backrest upward.
- ④  Press the button to adjust the backrest downward.

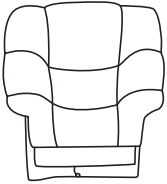
### Height adjustment for the whole Chair

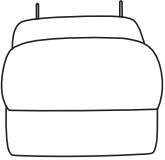
- ⑤  Press the button to adjust the chair upwards (sitting position);  
Press the button further to tilt the armchair forward (stand-up position).
- ⑥  Press the button to adjust the chair downward (reclining position).

The Chair with electric stand-up function can tilt up to 170 degrees.

<b>A</b>  Rückenlehne 1X	<b>B</b>  Armlehne 2X	<b>C</b>  Sitzbasis 1X	<b>D</b>  Fernbedienung 1X	<b>F</b>  Teil 2X
		<b>E</b>  Netzteil 1X	<b>G</b>  Teil 4X	

## Schritt 1

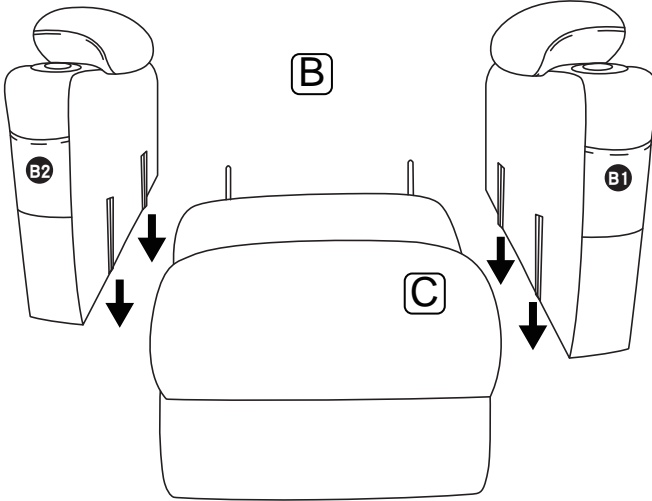

## Schritt 2

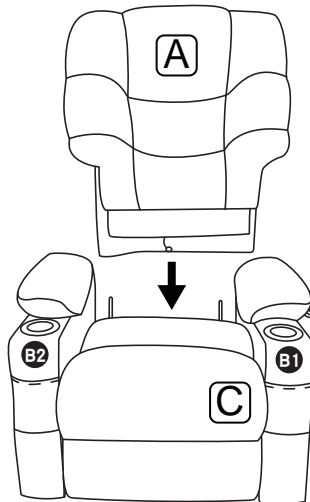

## Schritt 3

- Kabel ① und 1 derselben Farbe aus der Rückenlehne und den Kissen miteinander verbinden.
- Die USB Kabel mit dem Schnittstelle ② aus dem Sitzbasis verbinden.
- Fernbedienung **D** mit dem Schnittstelle ③ aus dem Sitzbasis verbinden.
- Netzteil **E** mit dem Schnittstelle ④ aus dem Sitzbasis verbinden.

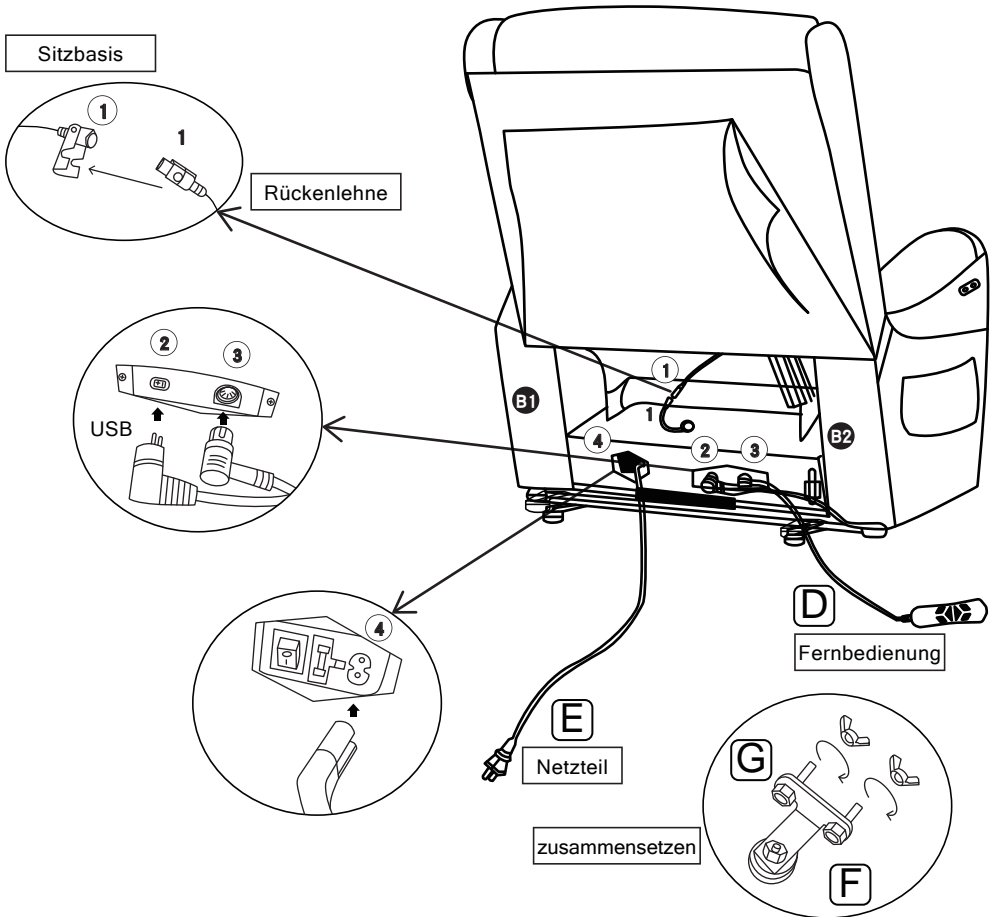

## HINWEIS:

Die USB-Schnittstelle ist an der Unterseite der Armlehne des Sofas eingebaut.  
Die Kabel des Motors ist um die Schubstange hinter der Sitzbasis gewickelt.

## Wie man sich zurücklehnt ?

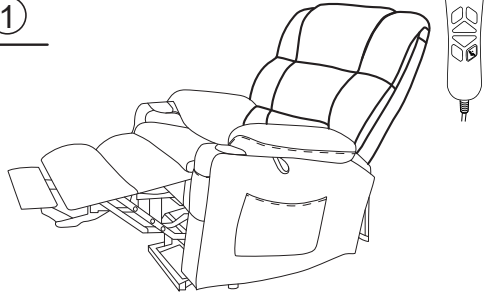
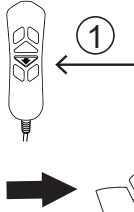
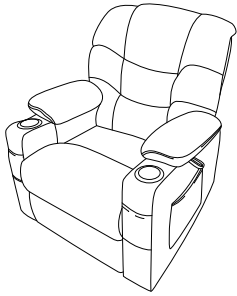

1. Drücken Sie den Knopf ① kann den Beinstütze stufenlos nach oben verstellen.

2. Drücken Sie den Knopf ② kann den Rückenlehne weiter bis zu 170 Grad neigen



## Wie man die Fußstütze einrasten lässt und steht ?

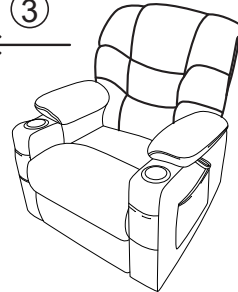
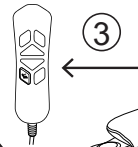
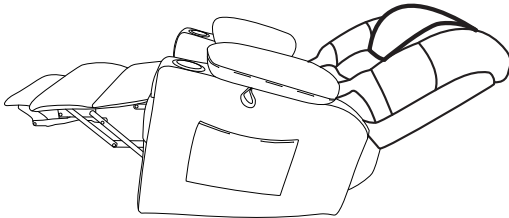

3. Drücken Sie den Knopf ③ kann die Rückenlehne wieder zu ursprünglicher Position zu erreichen

4. Drücken Sie den Knopf ④ um die Beinstütze wieder zu ursprünglicher Position zu erreichen. Halten Sie diesen Knopf gedrückt, kann das Sessel nach vorne neigen.







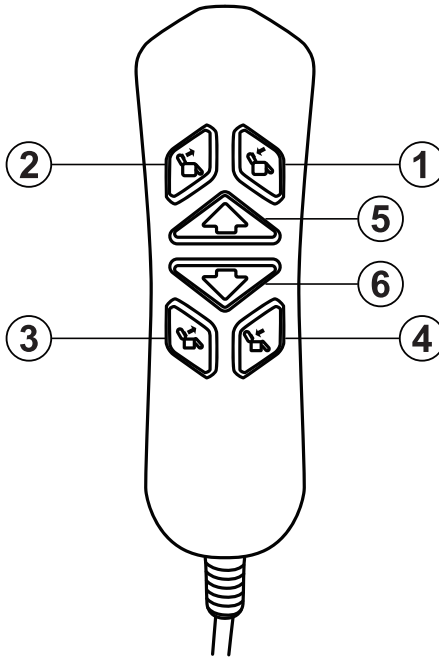

## Wie benutzt man die Fernbedienung ?





### Höhenverstellung für die Kopfstütze

- ①  Drücken Sie den Knopf um die Kopfstütze nach unten zu verstellen.
- ②  Drücken Sie den Knopf um die Kopfstütze nach oben zu verstellen.

### Höhenverstellung für die Rückenlehne





- ③  Drücken Sie den Knopf um die Rückenlehne nach oben zu verstellen.
- ④  Drücken Sie den Knopf um die Rückenlehne nach unten zu verstellen.

### Höhenverstellung für den ganzen Sessel

- ⑤  Drücken Sie den Knopf um den Sessel nach oben zu verstellen (Sitzposition);  
Drücken Sie den Knopf weiter um den Sessel nach vorne neigen (Aufstehhilfe).
- ⑥  Drücken Sie den Knopf um den Sessel nach unten zu verstellen (Liegeposition);

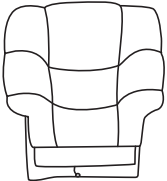
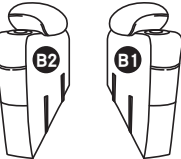
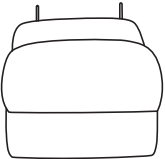
Der Sessel mit elektrischer Aufstehhilfe-Funktion kann sich bis 170 Grad neigen.

# Instructions de montage du canapé 7550

<b>A</b>  Dossier 1X	<b>B</b>  accoudoirs gauche et droit 2X	<b>C</b>  Base de chaise 1X	<b>D</b>  télécommande 1X	<b>F</b>  Pièces 2X
		<b>E</b>  Source d'alimentation 1X	<b>G</b>  Pièces 4X	

## ÉTAPE 1

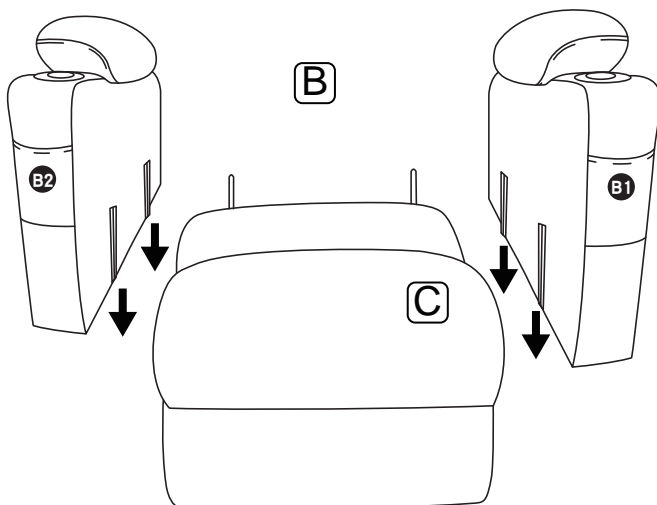

## ÉTAPE 2

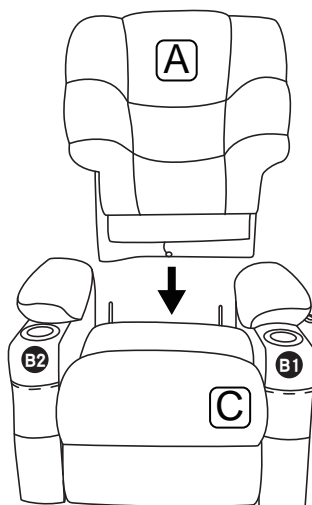

## ÉTAPE 3

- Connectez le câble ① et 1 de la même couleur du dossier et des coussins.
- Connectez le câble USB à l'interface ② de la base du siège.
- Connectez la télécommande **D** avec l'interface ③ de la base du siège.
- Connectez l'alimentation électrique **E** à l'interface ④ de la base du siège.

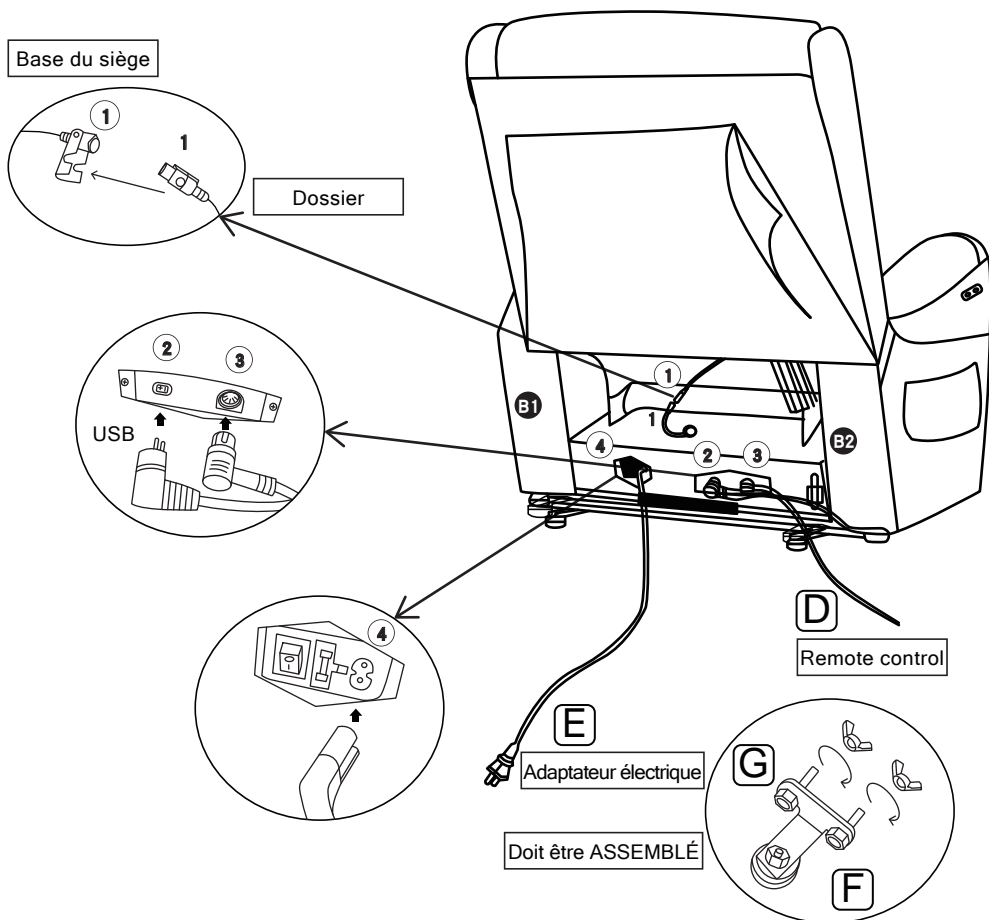

### NOTE :

Le port USB est installé sur le bas de l'accoudoir du canapé.

Le câble du moteur est enroulé autour de la tige de poussée derrière la base du siège.

## Comment recharger ?

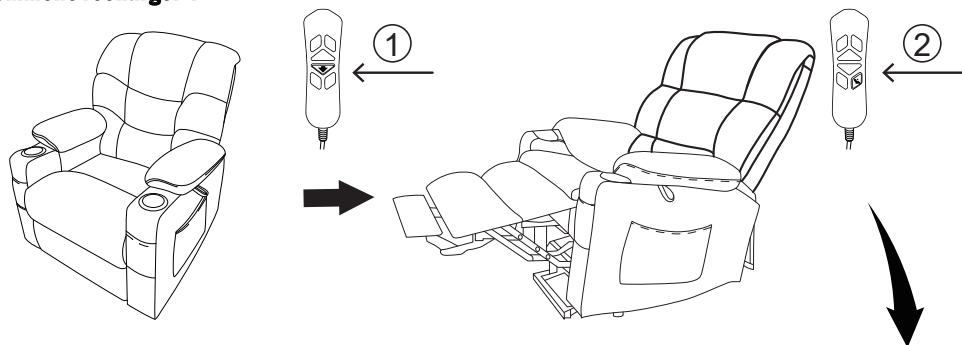

1. Appuyez sur le bouton ① peut incliner le repose - pieds en continu.
2. Appuyez sur le bouton ②, le dossier peut être incliné davantage jusqu'à 170 degrés.



## Comment mettre le repose - pieds en place et se tenir debout ?

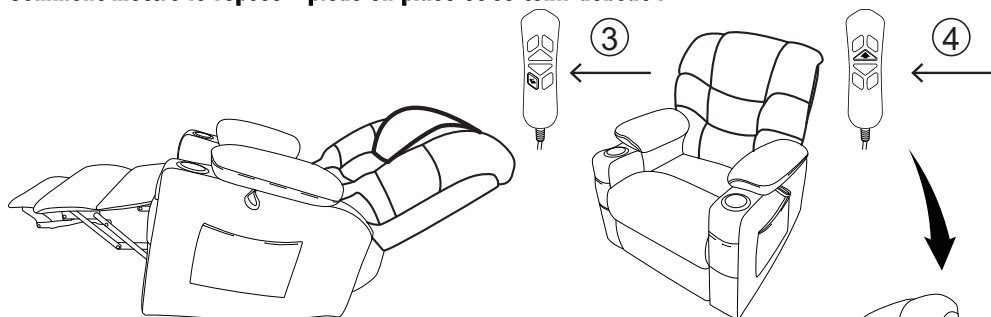



3. Appuyez sur le bouton ③ peut remettre le dossier dans sa position initiale.
4. Appuyez sur le bouton ④ pour remettre le repose - pieds dans sa position initiale. Maintenez ce bouton enfoncé, la chaise peut s'incliner vers l'avant.



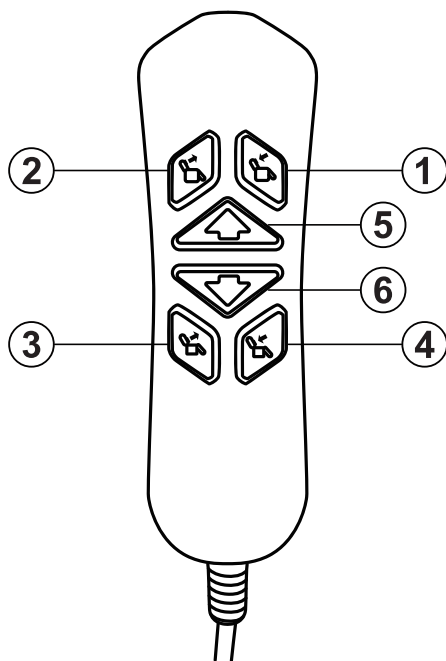

## Comment utiliser la télécommande ?





### Réglage de la hauteur de l'appui-tête

- ①  Appuyez sur le bouton pour régler l'appui-tête vers le bas.
- ②  Appuyez sur le bouton pour régler l'appui-tête vers le haut.

### Réglage de la hauteur du dossier





- ③  Appuyez sur le bouton pour régler le dossier vers le haut.
- ④  Appuyez sur le bouton pour régler le dossier vers le bas.

### Réglage de la hauteur pour toute la chaise

- ⑤  Appuyez sur le bouton pour régler le fauteuil vers le haut (position assise) ;  
Appuyez davantage sur le bouton pour incliner le fauteuil vers l'avant (position debout).
- ⑥  Appuyez sur le bouton pour régler le fauteuil vers le bas (position allongée).

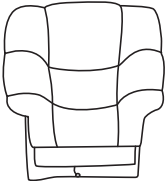
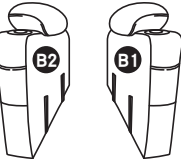
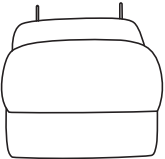
Le fauteuil avec fonction de verticalisation électrique peut s'incliner jusqu'à 170 degrés.

# Instrucción de montaje del sofá 7550

<b>A</b>  Respaldo 1X	<b>B</b>  reposabrazos 2X izquierdo y derecho	<b>C</b>  Base de la silla 1X	<b>D</b>  Control remoto 1X	<b>F</b>  Partes 2X
		<b>E</b>  Fuente de energía 1X	<b>G</b>  Partes 4X	

## PASO 1

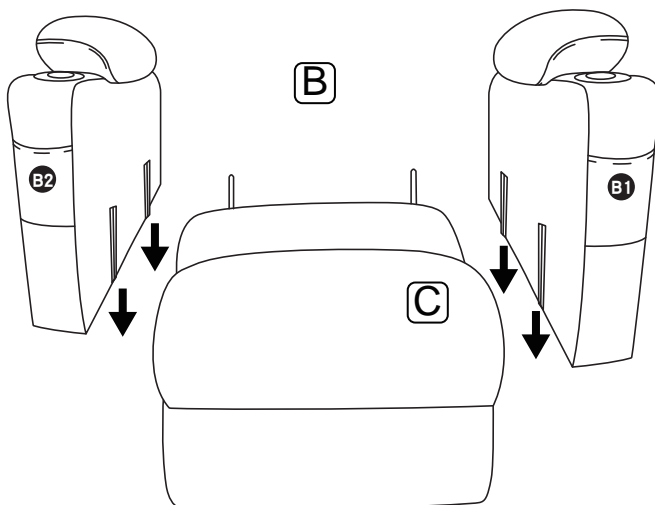

## PASO 2

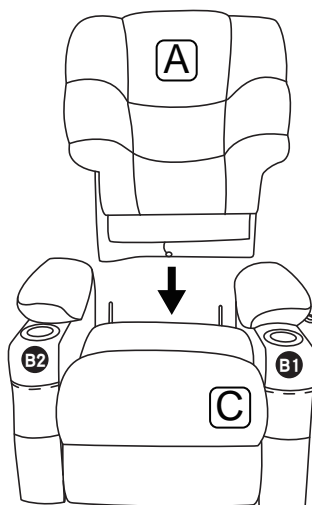

## PASO 3

- Conecte el cable ① y 1 del mismo color del respaldo y los cojines.
- Conecte el cable USB a la interfaz ② de la base del asiento.
- Conecte el mando a distancia **D** con la interfaz ③ de la base del asiento.
- Conecte la fuente de alimentación **E** con la interfaz ④ de la base del asiento.

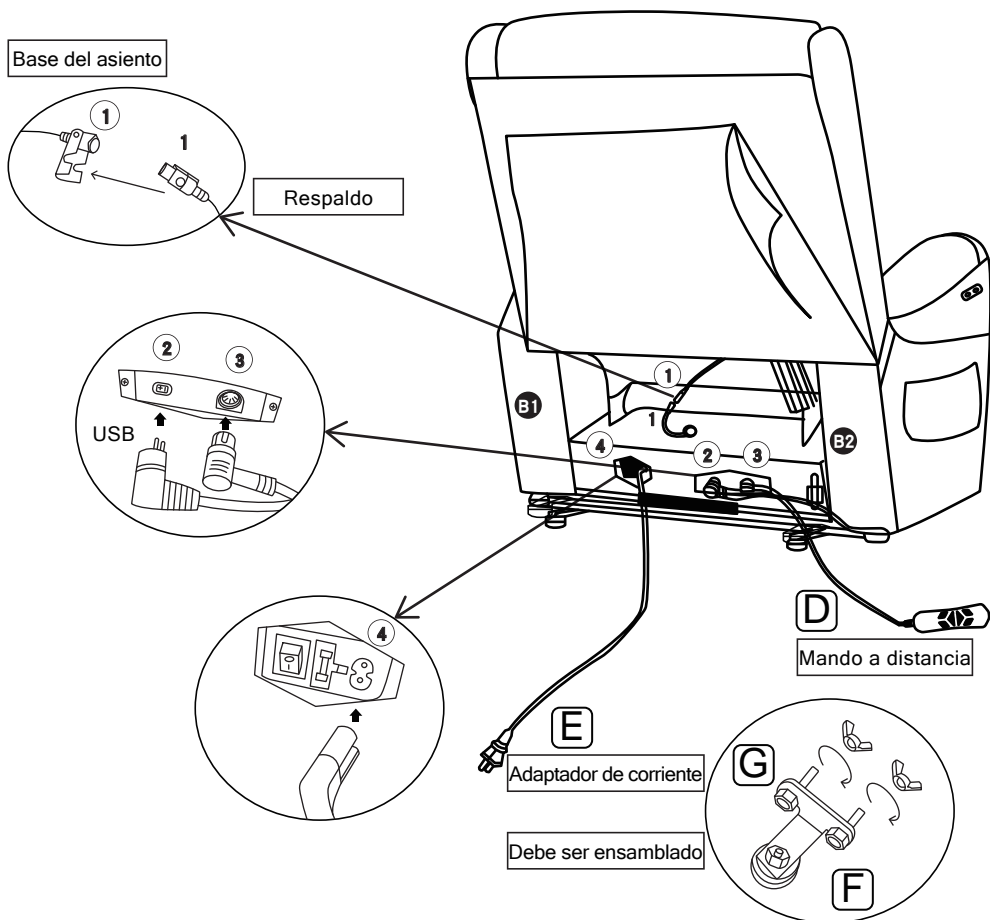

### NOTA :

El puerto USB está instalado en la parte inferior del reposabrazos del sofá.  
El cable del motor se enrolla alrededor de la varilla de empuje detrás de la base del asiento.

## ¿Cómo revestir ?

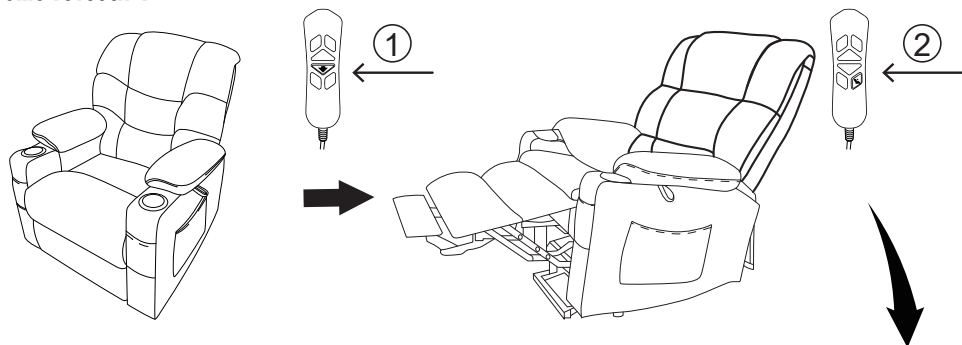

1. Pulse el botón ① puede reclinar el reposapiés de forma continua.
2. Presione el botón ②, el respaldo se puede inclinar más hasta 170 grados.

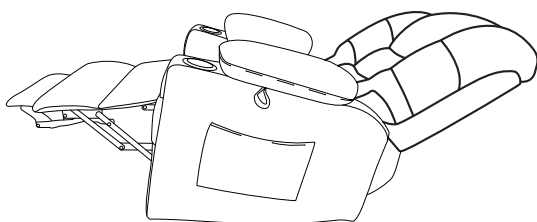

## ¿Cómo se encaja el reposapiés en su sitio y se pone de pie ?

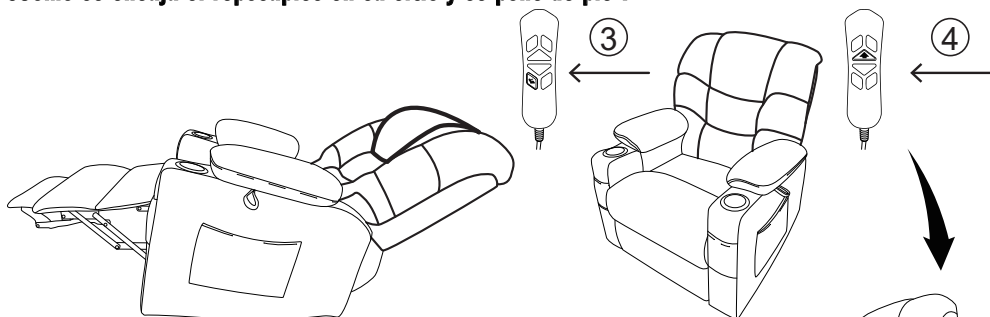



3. Pulse el botón ③ puede devolver el respaldo a su posición original.
4. Presione el botón ④ para devolver el reposapiés a su posición original. Mantenga presionado este botón, la silla puede reclinarsse hacia adelante.



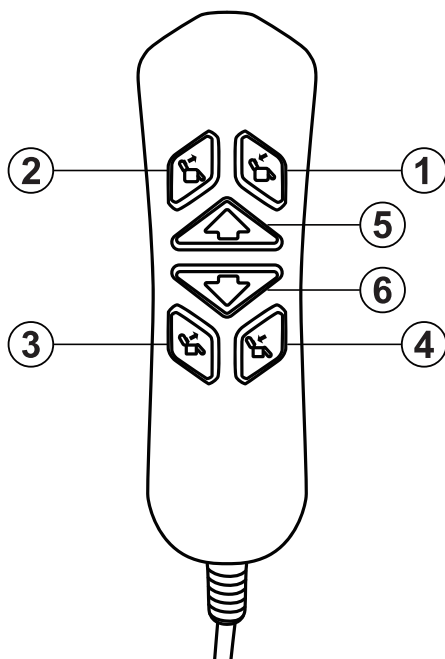

## ¿Cómo se utiliza el mando a distancia ?





### Ajuste de la altura del reposacabezas

- ①  Pulse el botón para ajustar el reposacabezas hacia abajo.
- ②  Pulse el botón para ajustar el reposacabezas hacia arriba.

### Ajuste de la altura del respaldo





- ③  Pulse el botón para ajustar el respaldo hacia arriba.
- ④  Pulse el botón para ajustar el respaldo hacia abajo.

### Ajuste de la altura de toda la silla

- ⑤  Pulse el botón para ajustar el sillón hacia arriba (posición de sentado);  
Pulse más el botón para inclinar el sillón hacia delante (posición de pie).
- ⑥  Pulse el botón para ajustar el sillón hacia abajo (posición reclinada).

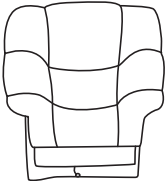
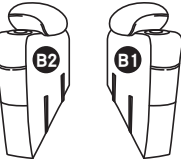
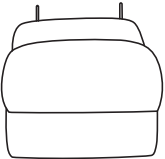
La silla con función de bipedestación eléctrica puede inclinarse hasta 170 grados.

# Istruzioni per il montaggio del divano 7550

<b>A</b>  Schienale 1X	<b>B</b>  bracciolo sinistro e destro 2X	<b>C</b>  Base della sedia 1X	<b>D</b>  Controllo remoto 1X	<b>F</b>  Parti 2X
		<b>E</b>  Fonte di alimentazione 1X	<b>G</b>  Parti 4X	

## PASSO 1

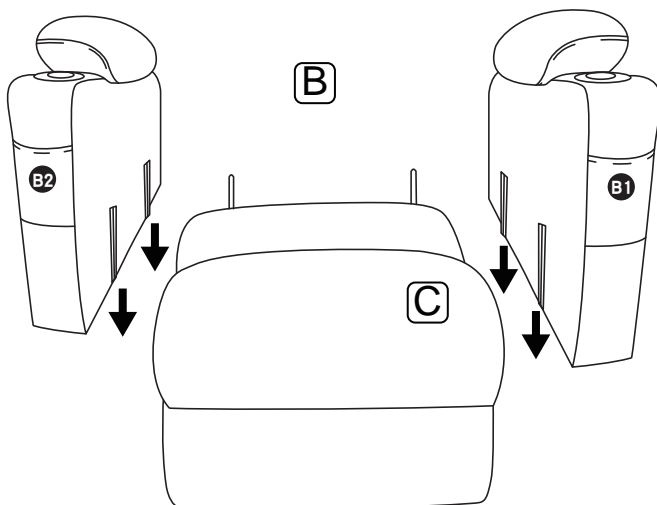

## PASSO 2

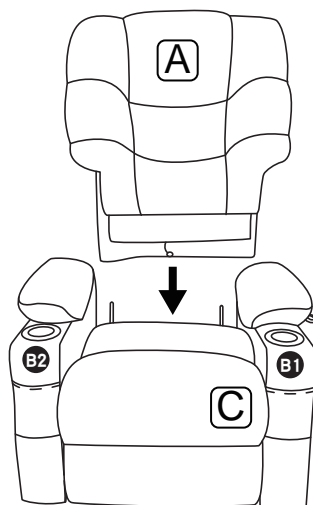

## PASSO 3

- Collegare il cavo ① e 1 dello stesso colore dallo schienale e dai cuscini.
- Collegare il cavo USB all'interfaccia ② sulla base del sedile.
- Collegare il telecomando **D** all'interfaccia ③ della base del sedile.
- Collegare l'alimentatore **E** all'interfaccia ④ della base del sedile.

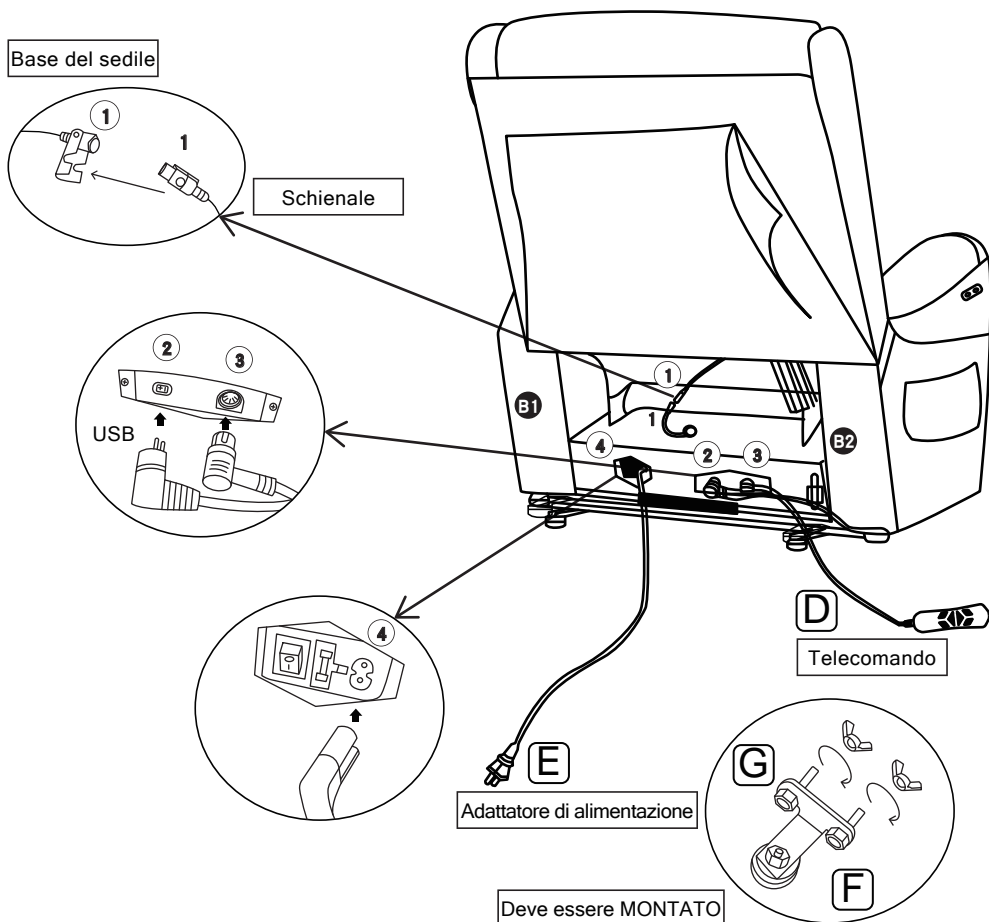

### NOTA :

La porta USB è installata sul fondo del bracciolo del divano.

Il cavo del motore è avvolto intorno all'asta di spinta dietro la base del sedile.

## Come reclinare ?

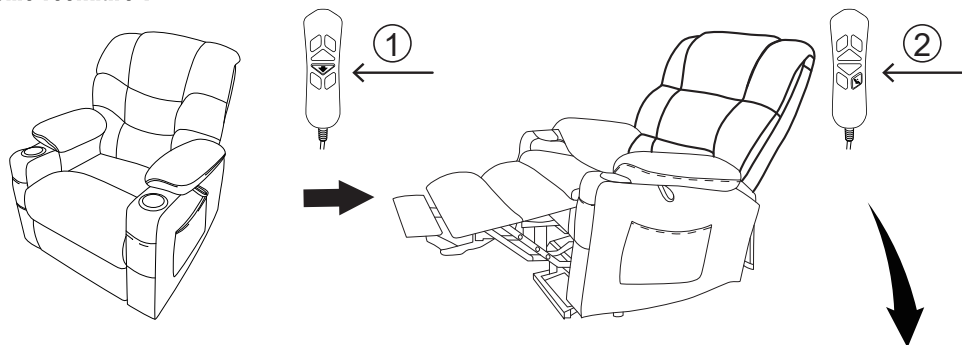

1. premere il pulsante ① può reclinare il poggiatesta continuamente.
2. Premere il pulsante ②, lo schienale può essere inclinato ulteriormente fino a 170 gradi.

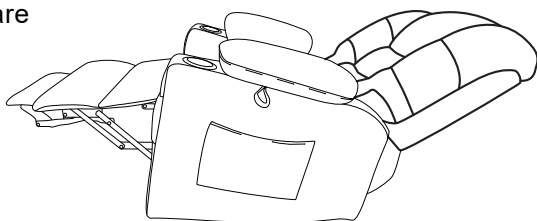

## Come si fa a scattare il poggiatesta in posizione e in piedi ?

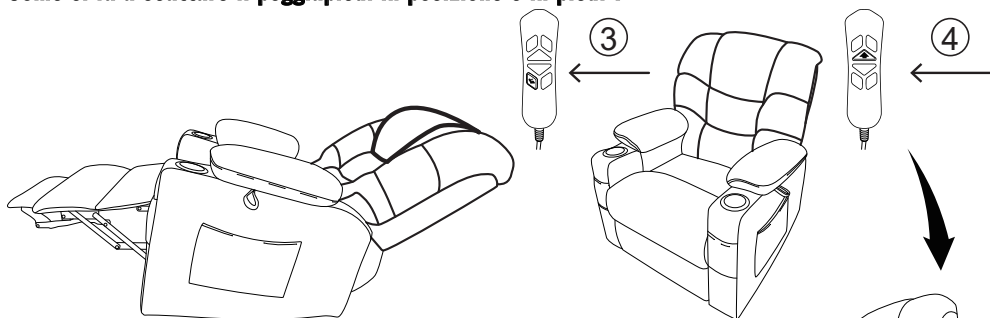



3. Premere il pulsante ③ può riportare lo schienale nella posizione originale.
4. Premere il pulsante ④ per riportare il poggiatesta nella posizione originale. Tenendo premuto questo pulsante, la sedia può reclinarsi in avanti.

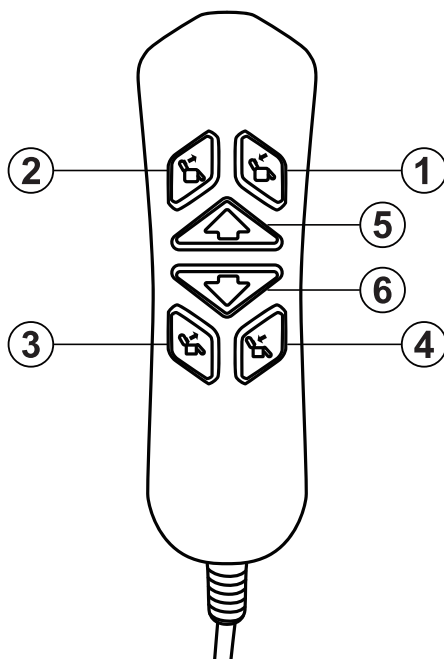

## Come usare il telecomando ?





### Regolazione dell'altezza del poggiatesta

- ①  Premere il pulsante per regolare il poggiatesta verso il basso.
- ②  Premere il pulsante per regolare il poggiatesta verso l'alto.

### Regolazione dell'altezza dello schienale

- ③  Premere il pulsante per regolare lo schienale verso l'alto.
- ④  Premere il pulsante per regolare lo schienale verso il basso.

### Regolazione dell'altezza per tutta la sedia

- ⑤  Premere il pulsante per regolare la poltrona verso l'alto (posizione seduta);  
Premere ulteriormente il pulsante per inclinare la poltrona in avanti (posizione in piedi).
- ⑥  Premere il pulsante per regolare la poltrona verso il basso (posizione reclinata).

La poltrona con funzione stand-up elettrica può inclinarsi fino a 170 gradi.



## Pfillo GmbH

---

Adresse: Kreuzweg 60, 47809

Krefeld, Germany

E-Mail: [pfillo.de@gmail.com](mailto:pfillo.de@gmail.com)

Webseite: [www.mcombo.de](http://www.mcombo.de)

© MCombo; 3. Auflage. 2022



[mcombo.de](http://mcombo.de)



[MCombo - Amazon.de](https://www.amazon.de)