

pelipal

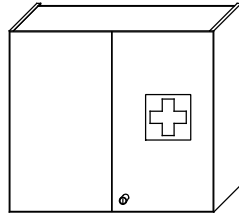

MOT-NZ0826S1 | A4
Datum 24/02/20

980-015035

T1 Bitte unbedingt ausfüllen!

Name -----
Strasse -----
Plz ----- Ort -----
Tel. -----

T2 Sehr geehrte Kunden,
wir freuen uns, dass Sie sich für ein Produkt aus dem Hause Pelipal entschieden haben. Sollte es trotz aller Bemühungen unsererseits, Ihnen ein qualitativ hochwertiges Möbelstück zu liefern, zu Fehlteilen kommen, schicken Sie bitte dieses ausgefüllte Blatt an
Fax.: **+49 3443/434350**
E-Mail: **ersatzteile@pelipal.de**
Bitte beachten Sie, dass Bauteile über 800mm Länge und 350mm Breite direkt bei Ihrem Möbelhändler zu beanstanden sind. Zur Reklamationsbearbeitung ist es unbedingt erforderlich **die Artikelnummer des Schrankes**, welche auf dem Etikett ersichtlich ist und den Markt, wo das Möbel erworben wurde anzugeben. Außerdem tragen Sie unten bitte die benötigte Stückzahl ein. Viel Spaß mit Ihrem neuen Badmöbel! Ihr Pelipal Team

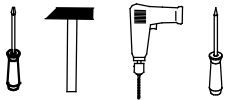





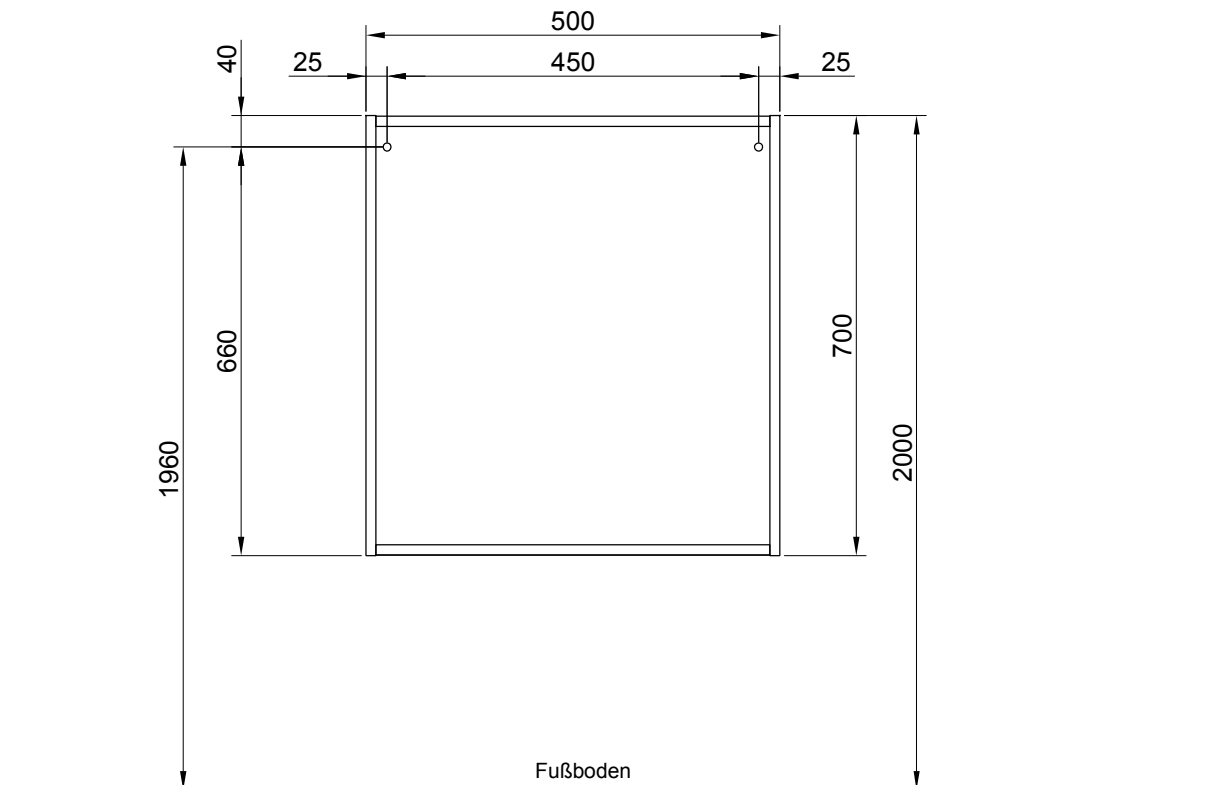



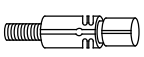

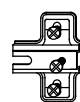
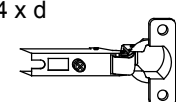
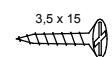
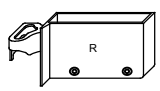
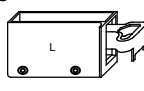
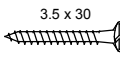

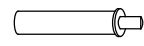
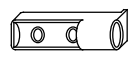
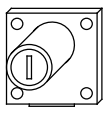

T3 Für den Zusammenbau sind 2 Personen erforderlich.

T4 Montage-Richtzeit 3 Stunden

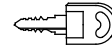

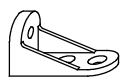
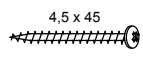
Die Maßangabe der Höhe ist nicht bindend!

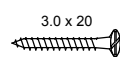
8 x a  DÜB-SMD-000005	Stück	8 x b  EXZENTER-000015	Stück	4 x c  ZPL-016X000	Stück	4 x d  TBD-26-115X00	Stück	13 x e  SCH-SPA-035X015	Stück
1 x f  AUF-001-000085	Stück	1 x g  AUF-001-000095	Stück	4 x h  SCH-SPA-035X030	Stück	2 x i  AUF-001-000020	Stück	2 x k  SCH-RDK-030X015	Stück
16 x l  TRAE-001-000020	Stück	12 x m  NAGEL-025X001	Stück	1 x n  MDS-003-000040	Stück	2 x o  TUER-DAEM-000010	Stück	2 x p  TUER-ADA-000010	Stück
1 x q  SCHL-MED-9803035	Stück	1 x r  SCHL-MED-9803035	Stück	1 x s  SCHL-MED-9803035	Stück	2 x t  SCHL-MED-9803035	Stück	1 x u  AUFKL-MED-9803035	Stück
1 x v  VBD-000020		1 x w  SCH-RDK-045X045		1 x x  SCH-RDK-040X015		4 x y  SCH-SPA-030X020			

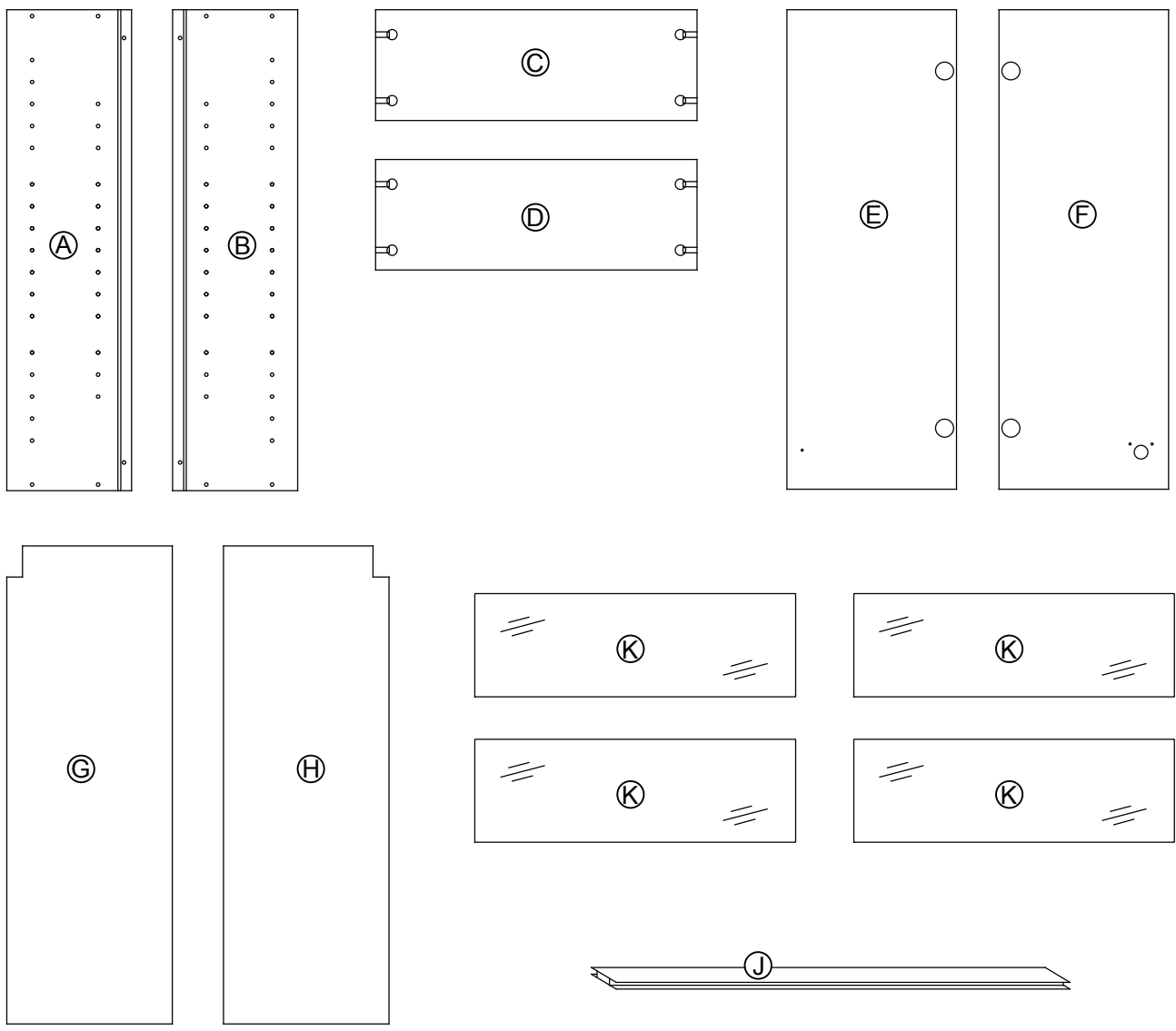

1.

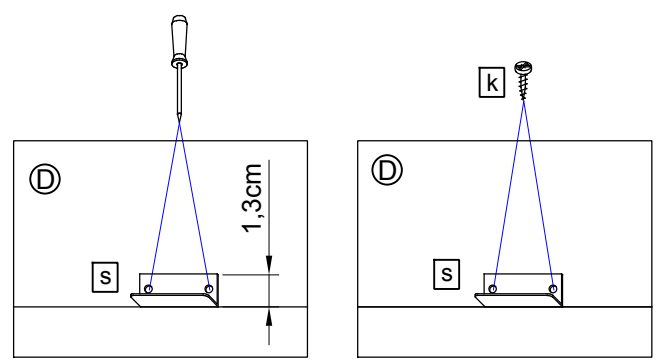
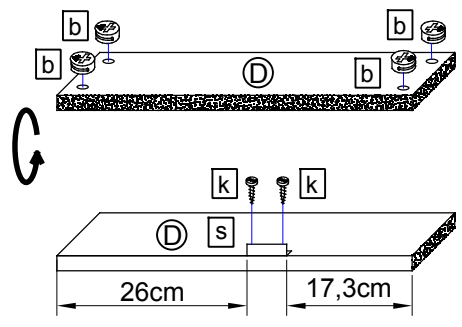
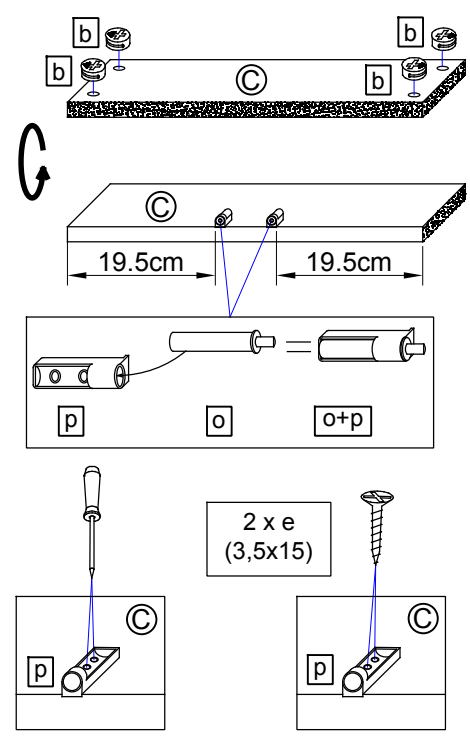
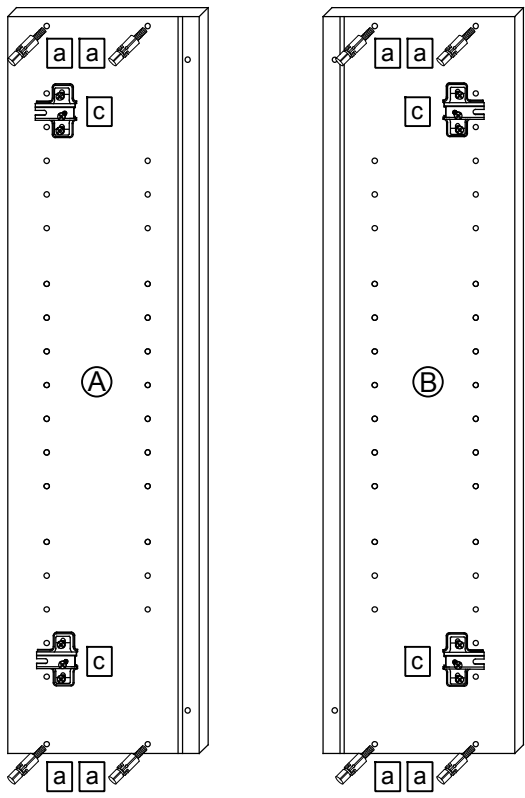
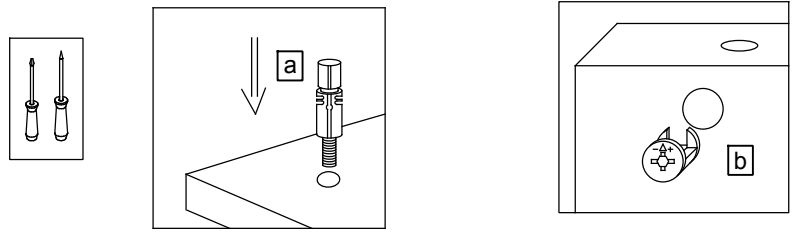

2.

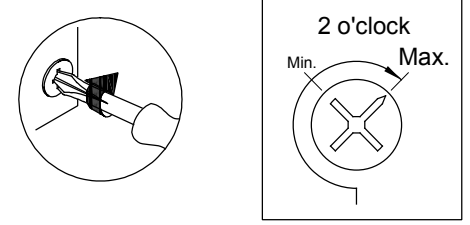
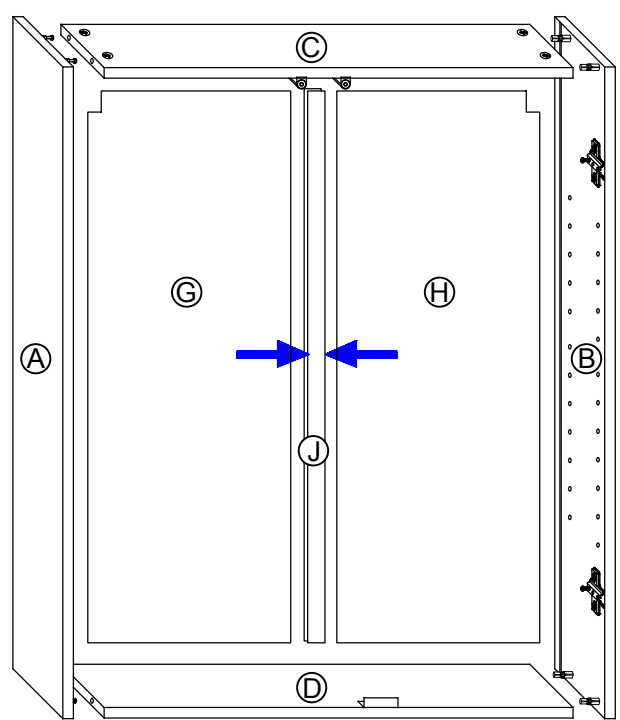
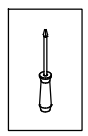

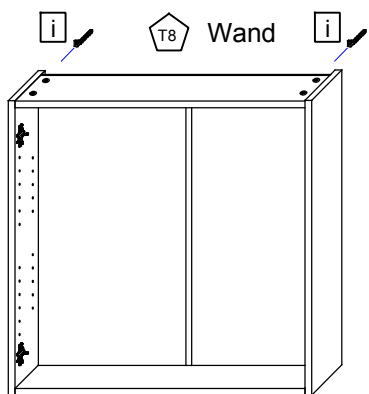
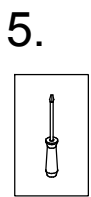
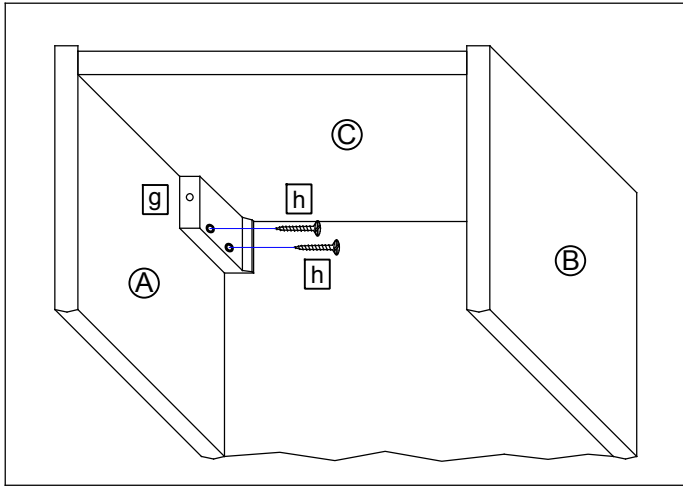
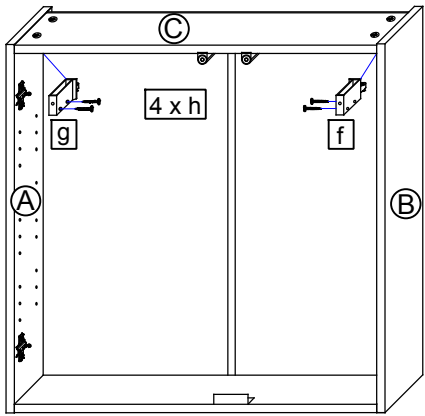
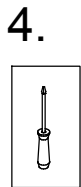
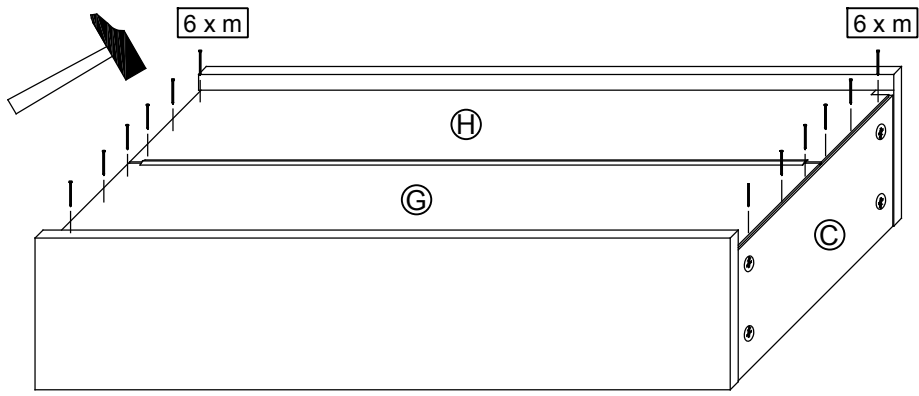
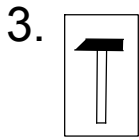

- Achtung! Bei fehlerhafter Montage können Schäden durch das Herabstürzen des Schrankes entstehen.
- Lassen Sie den Schrank nur durch fachkundige Personen mit für die Wand geeignetem Montagematerialien montieren.
- Achten Sie beim Aufhängen des Schrankes darauf, dass der Schrankaufhänger richtig in den Schraubhaken einrastet.

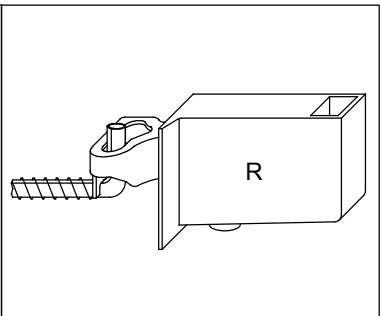
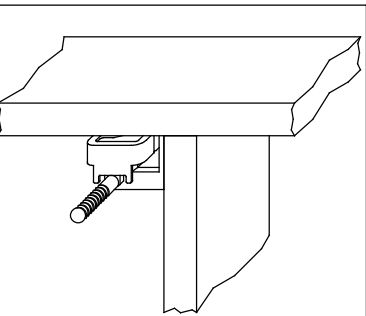
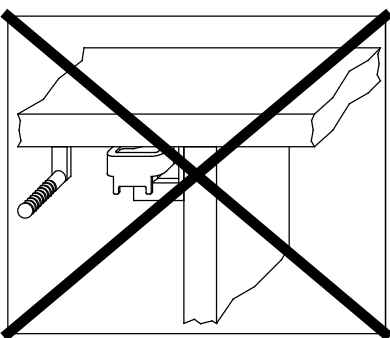
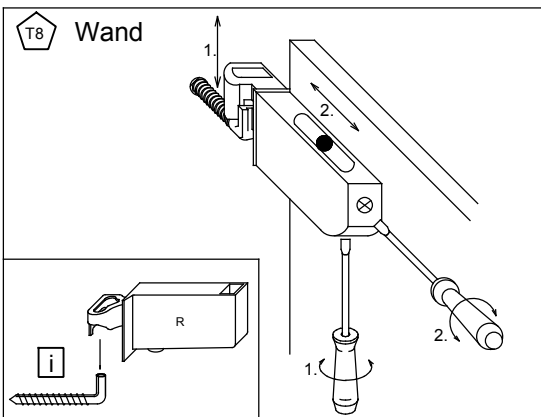
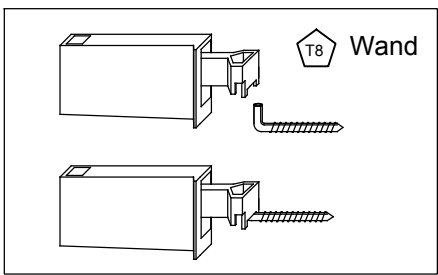

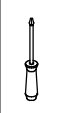
6. 

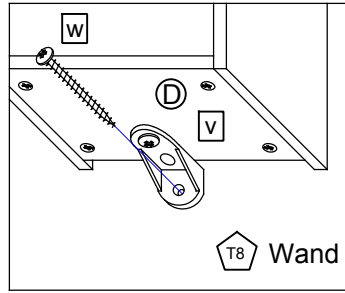
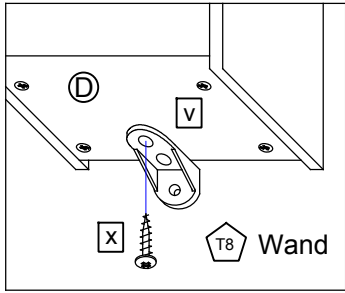

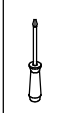
7. 

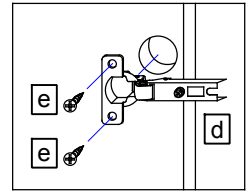
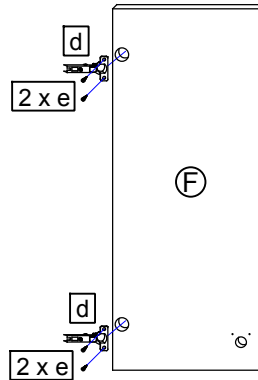
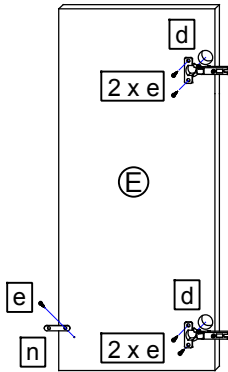
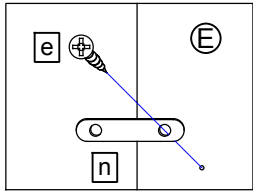

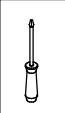
8. 

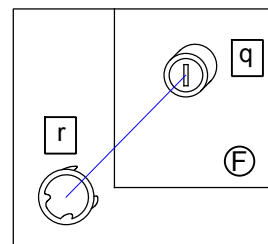
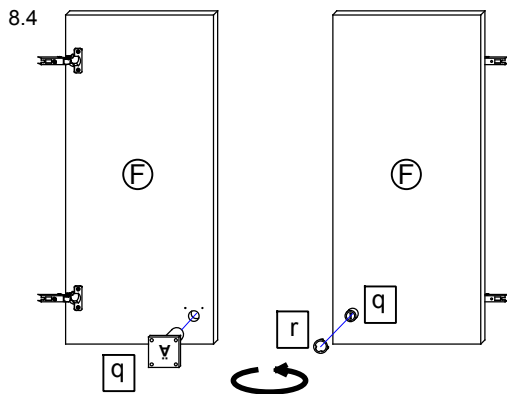
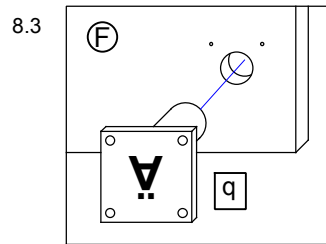
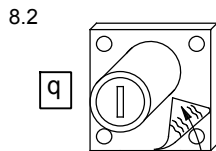
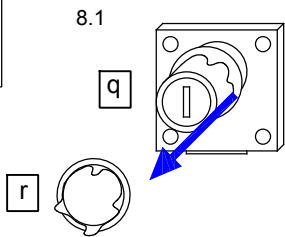

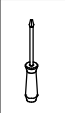
9. 

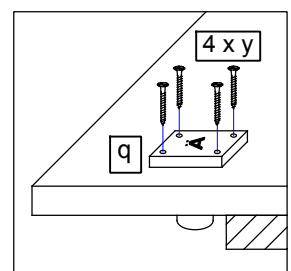
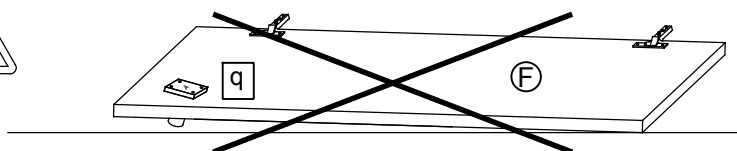
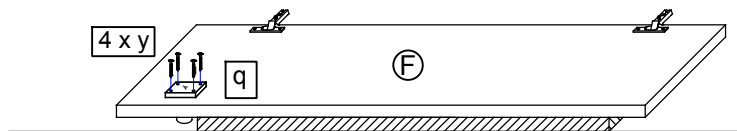

10.

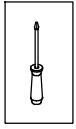

Bei Türmontage das Scharnier einhängen, bis Anschlag öffnen und anschließend festschrauben.

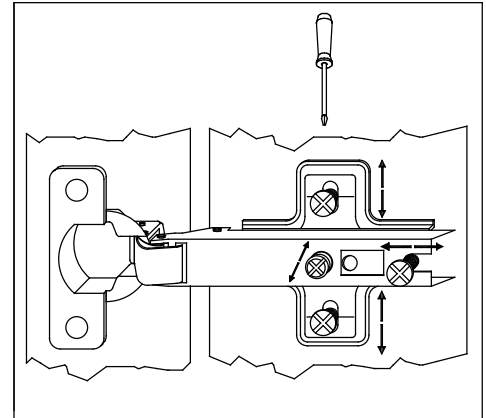
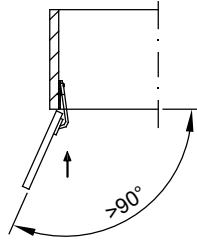
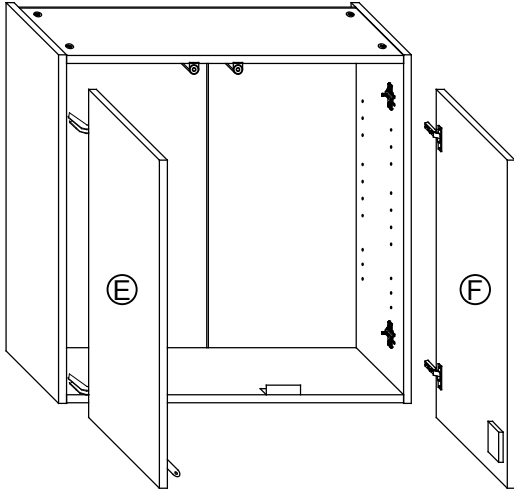

11.

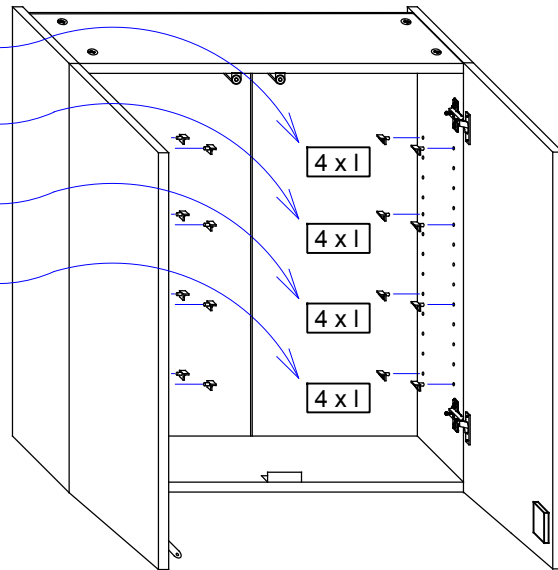
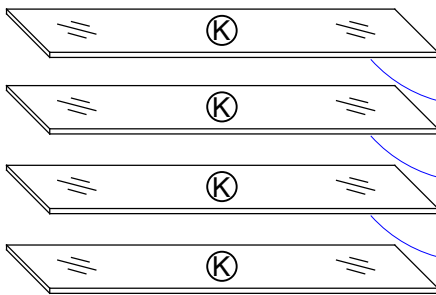

12.

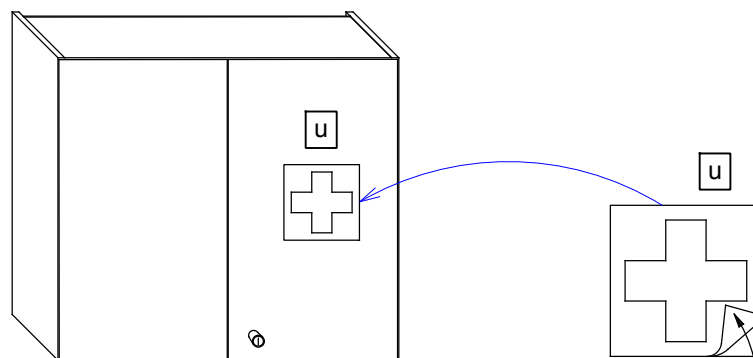

Das Möbel bitte nur mit einem feuchten Tuch reinigen.