

BWiX9017

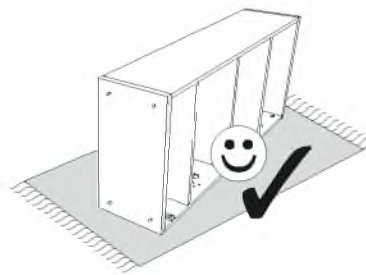

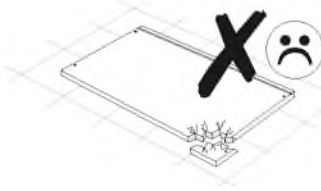
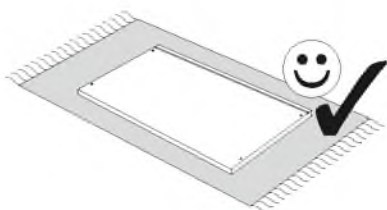
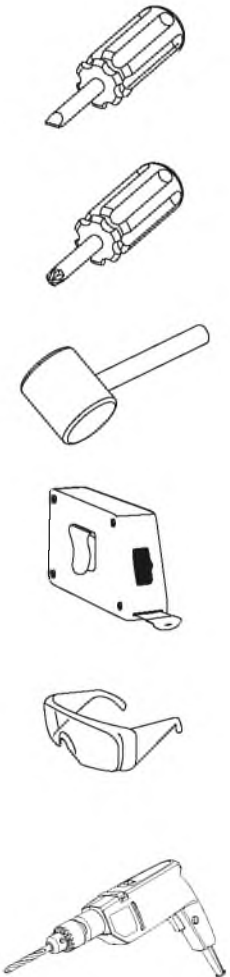
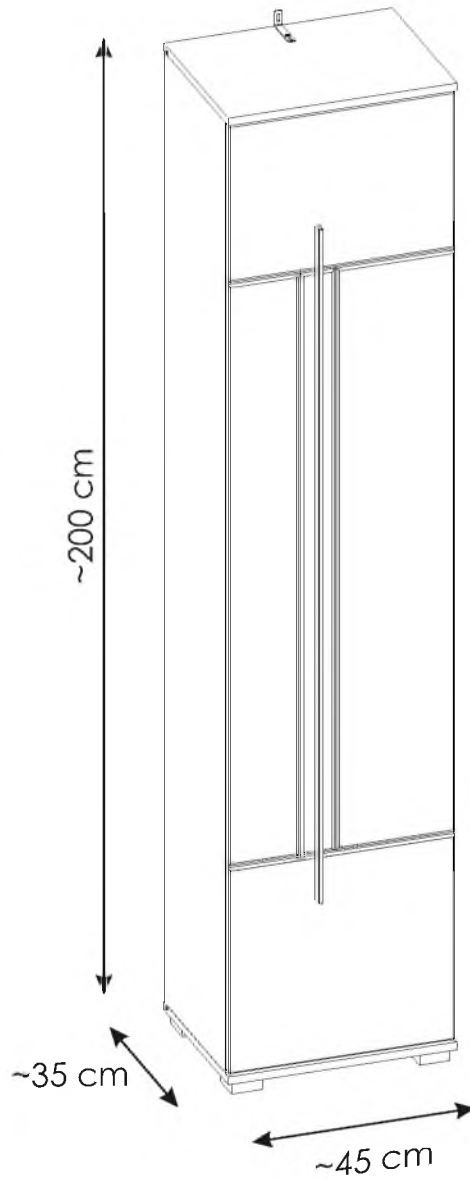
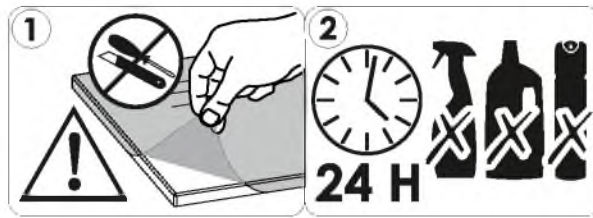
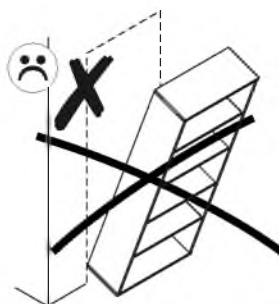
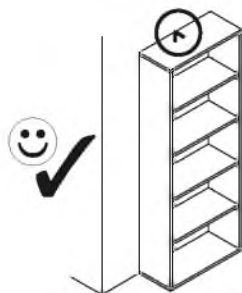

PL.

UWAGA! Mebel należy trwale zamocować do ściany, aby uniknąć ryzyka związanego z przewróceniem się mebla.

W paczce nie ma śrub mocujących, ponieważ rodzaj mocowania należy odpowiednio dobrać do rodzaju ściany. Dobierz właściwe do Twojego rodzaju ściany.

D.

ACHTUNG! Um alle mit dem Umkippen des Möbels verbundenen Risiken auszuschließen, muss das Möbel fest an der Wand verankert werden. Beschläge für die Wandbefestigung sind nicht beige packt, da diese von der jeweiligen Wandbeschaffenheit abhängig sind. Bitte solche Befestigungsschläge wählen, die für die heimischen Wände geeignet sind.

FR.

ATTENTION! Ce meuble doit être fixé en permanence au mur pour éviter les risques de chute. Les vis de fixation ne sont pas livrées car le type de fixation doit être choisi en fonction du type de mur. Sélectionnez les fixations adaptées au mur.

I.

ATTENZIONE! Il mobile deve essere permanentemente fissato alla parete per evitare i rischi derivanti da un ribaltamento del mobile. La confezione non include le viti di fissaggio, in quanto il tipo di fissaggio deve essere scelto in base al tipo di parete. Utilizzare viti appropriate in base al materiale della parete.

HR.

NAPOMENA! Namještaj mora biti trajno pričvršćen za zid, kako bi se izbjegao rizik od njegova prevrtanja. U paketu nema vijaka za pričvršćivanje, jer se vrsta montaže mora prilagoditi vrsti zida. Odaberite pravu vrstu prema Vašoj vrsti zida.

EN.

WARNING! To prevent this furniture from tripping over, fix it to the wall permanently. Fixing devices are not included since different wall materials require different types of fixing devices. Please make sure you chose the correct ones for your type of wall.

SK.

POZOR! Nábytok musí byť trvalo pripevnený k stene tak, aby sa zamedzilo riziku prevrátenia. Balík neobsahuje upevňovacie skrutky, pretože typ upevnenia je treba vybrať podľa typu steny. Vyberte typ vhodný pre Vašu stenu.

CZ.

POZOR! Nábytek je nutné pevně připevnit ke zdi, abychom se vyhnuli riziku spojenému s jeho převrnutím. Součástí balení nejsou upevňovací šrouby, protože způsobu připěvnění je nutné zvolit podle druhu stěny. Vyberte správný pro Váš typ stěny.

RU.

ПРИМЕЧАНИЕ! Эту мебель необходимо всегда прикреплять к стене, чтобы избежать рисков, связанных с переворотом мебели. В пакете нет крепежных винтов, потому что тип крепления должен быть выбран в соответствии с типом стены. Выберите, пожалуйста, правильные винты к вашей стене.

RO.

ATENȚIE! Mobila trebuie ancorată permanent în perete pentru a evita riscul de răsturnare a mobilei. În pachet nu sunt incluse șuruburile de fixare, deoarece tipul de ancoraj trebuie ales în funcție de tipul de perete. Alegeți șuruburile potrivite pentru tipul Dvs. de perete.

TR.

DİKKAT! Devrime riskini önlemek için mobilya duvara sabitlenmelidir. Sabitleme civataları pakete dahil değil, çünkü sabitleme teribatının tipi, duvara tipine uygun olarak seçilmelidir. Onu duvarınızın tipine göre seçiniz.

AR.

ملاحظة!

يجب تثبيت الأثاث بإحكام إلى الحائط أو الجدار لتجنب خطر إنقلابه. لا تحتوي اللعبة على مسامير التثبيت، إذ إنه ينبغي إستعمال المسامير المخصصة لنوعية الحائط أو الجدار. اختر المسامير التي تناسب جدارك.

E.

¡ATENCIÓN! El mueble debe ser fijado permanentemente a la pared para evitar el riesgo relacionado con el vuelco del mueble. En el paquete no hay tornillos de fijación, ya que se debe elegir el tipo de fijación adecuado para el tipo de pared. Elija el apropiado para su tipo de pared.

CN.

注意！本家具需要固定在墙上以免倒塌。箱子里没有安装螺钉。因为安装方式需要根据墙的类型调整。请按照您的墙类型选择合适的安装方式。

SLO.

POZOR! Pohišivo trajno pritrdite na steno, da preprečite tveganje, da se prevrne. V paketu ni pritrdilnih vijakov, saj je treba način pritrditve ustrezno izbrati glede na vrsto stene. Izberite način, ki je ustrezen za vašo steno.

HU.

FIGYELEM! Rögzítse a bútorokat a falhoz, hogy elkerülje a bútor felborulásának kockázatát. A készletben nem találhatóék rögzítőcsavarok, mivel a rögzítés típusa a fal típusától függ. Válassza ki a fal típusának megfelelő kötőelemeket.

NL.

OPMERKING! De meubelen moeten permanent aan de muur worden bevestigd om te voorkomen dat de meubelen kantelen. Er zitten geen bevestigingsschroeven in het pakket, omdat het type bevestiging moet worden gekozen op basis van het type muur. Kies de juiste voor uw type muur.

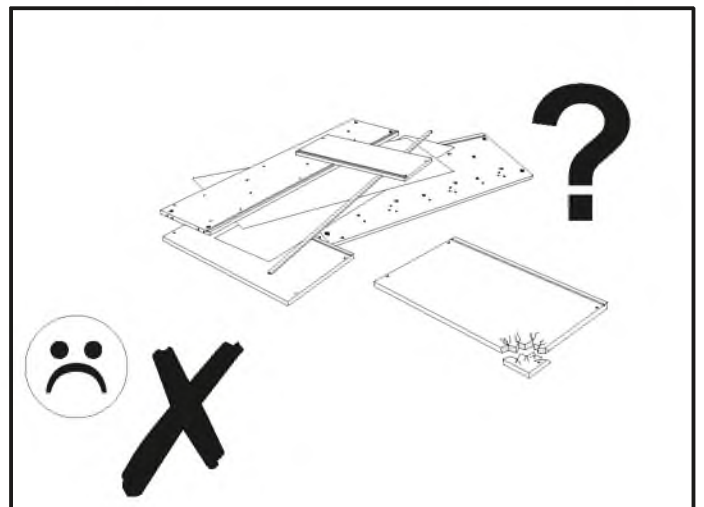
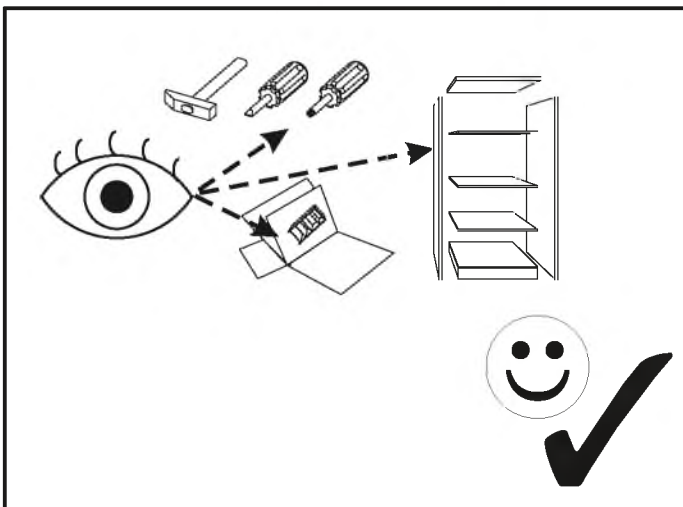
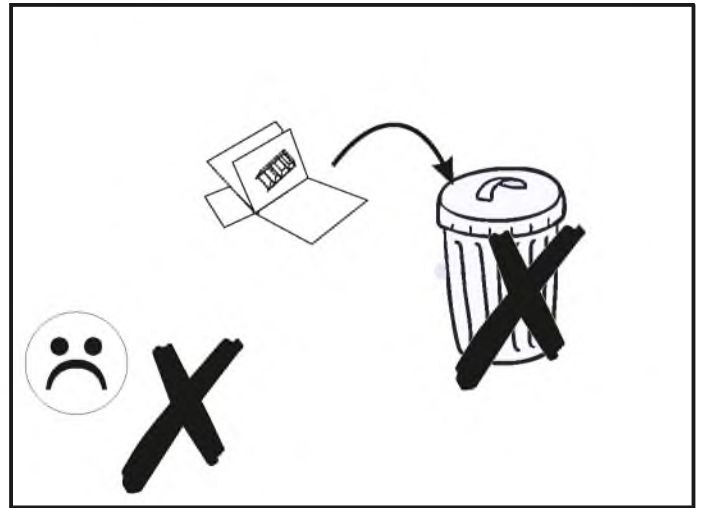
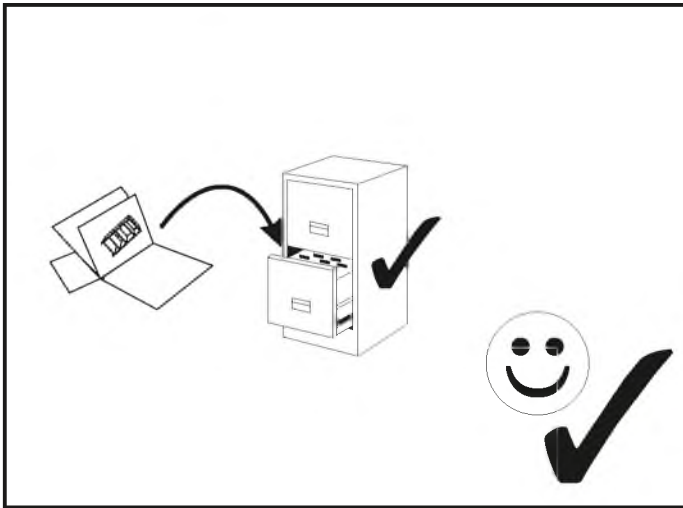
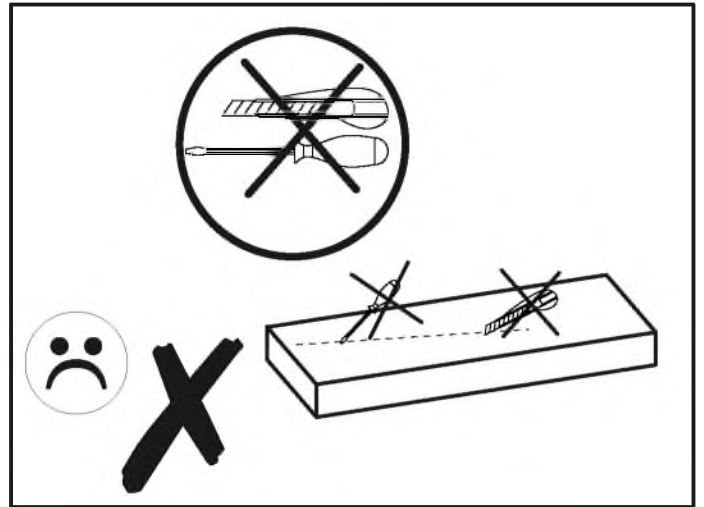
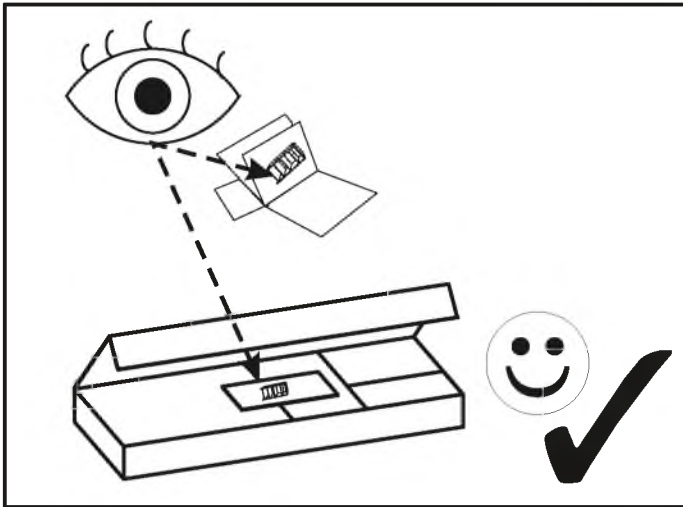



version A





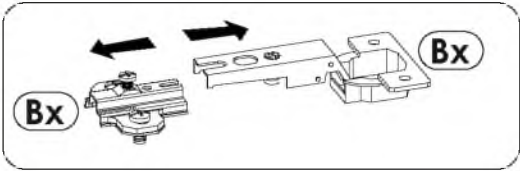
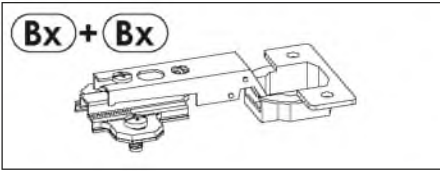
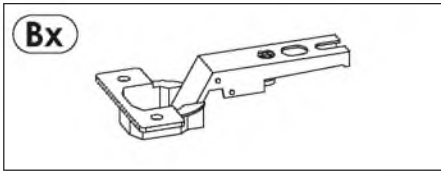
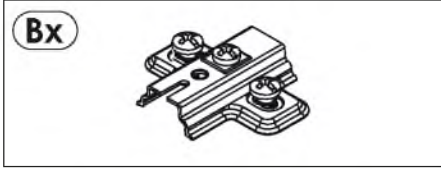



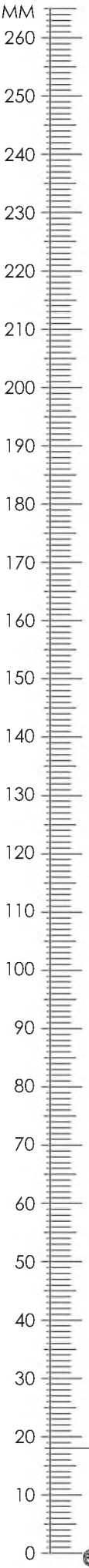

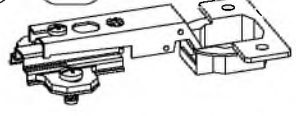

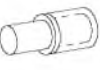



version B

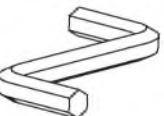

BWiX9017

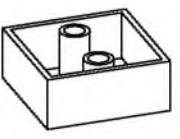
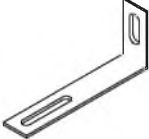

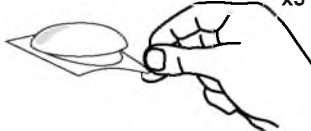
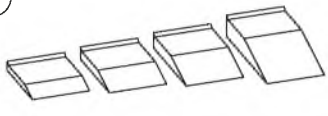
A1 8 x 35 mm x12 	B0 + B1 x4 	C2 5 x 13 mm x8 
D2 x16 	E0 Ø16 x8 	E1 15 x 12 mm x8 
F1 6 x 34 mm x8 	G1 7 x 50 mm x4 	H1 L - 1376 mm x1 
I2 4 x 16 mm x1 	I6 3,5 x 27 mm x7 	I12 4 x 30 mm x8 
M x1 	N1 3 X 16 mm x5 	O2A ø20 x8 
O4 x4 	Q9 x1 	R4 x12 
R8 x3 	Z x1 	

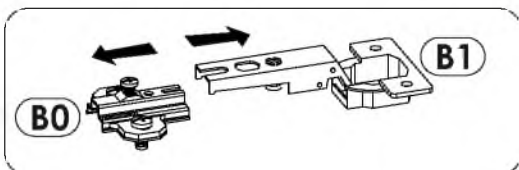

BWiX9017

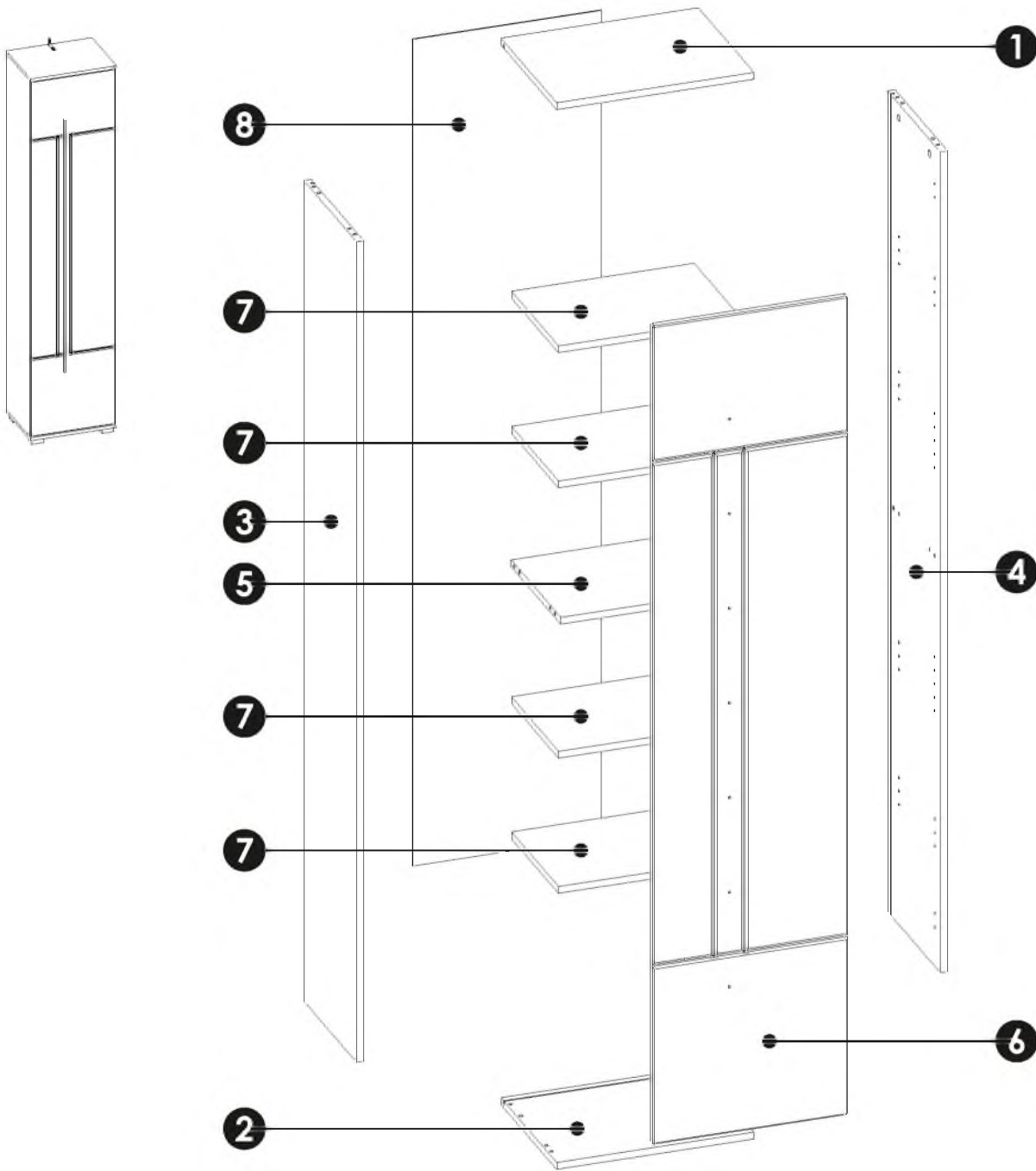

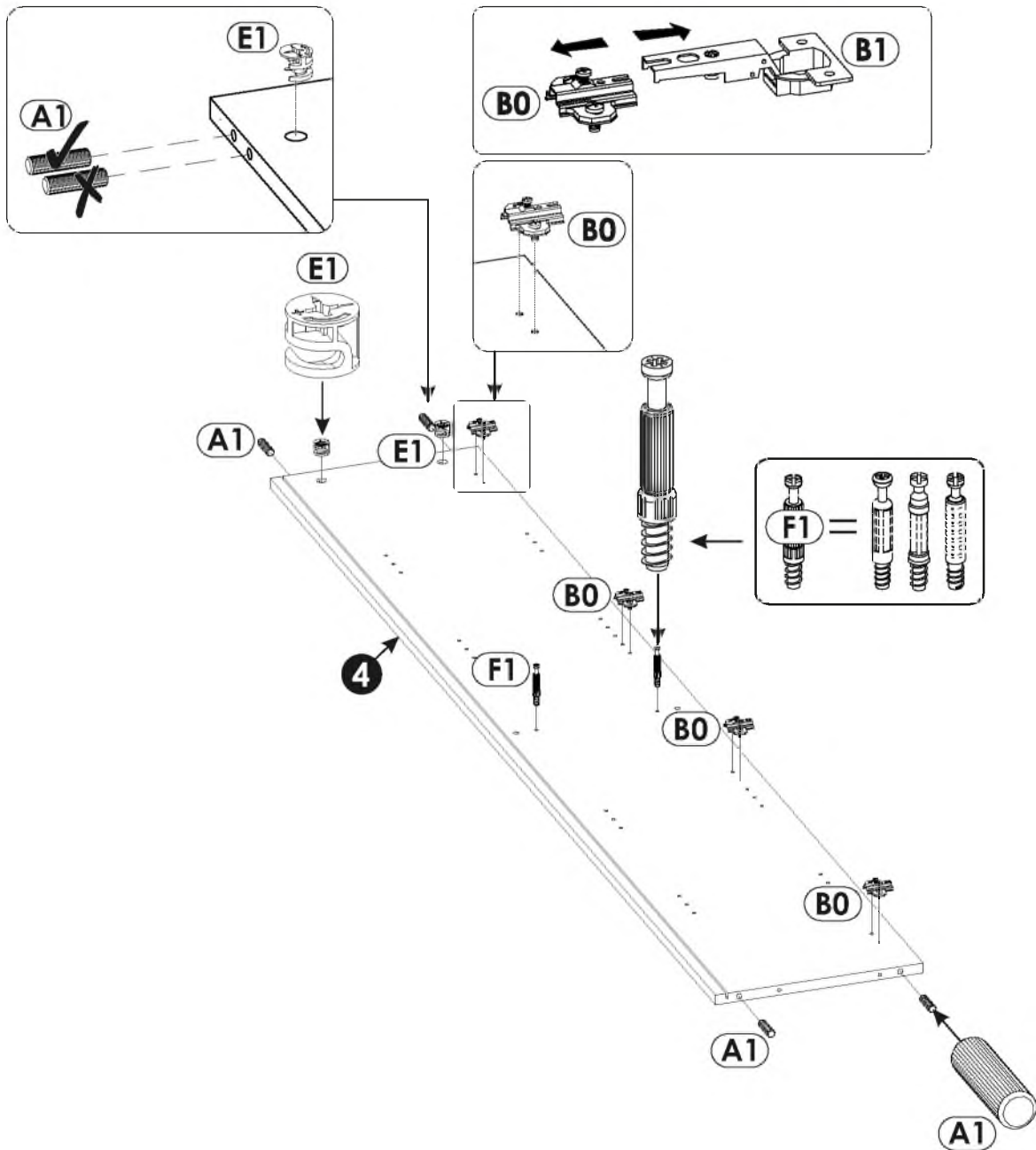
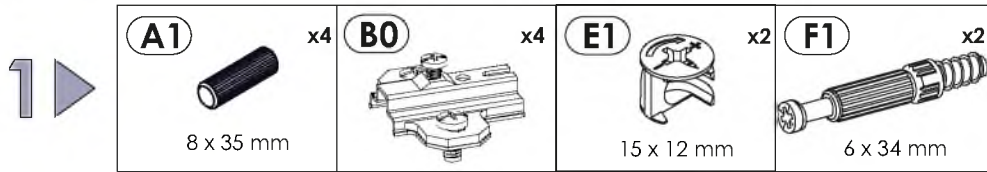
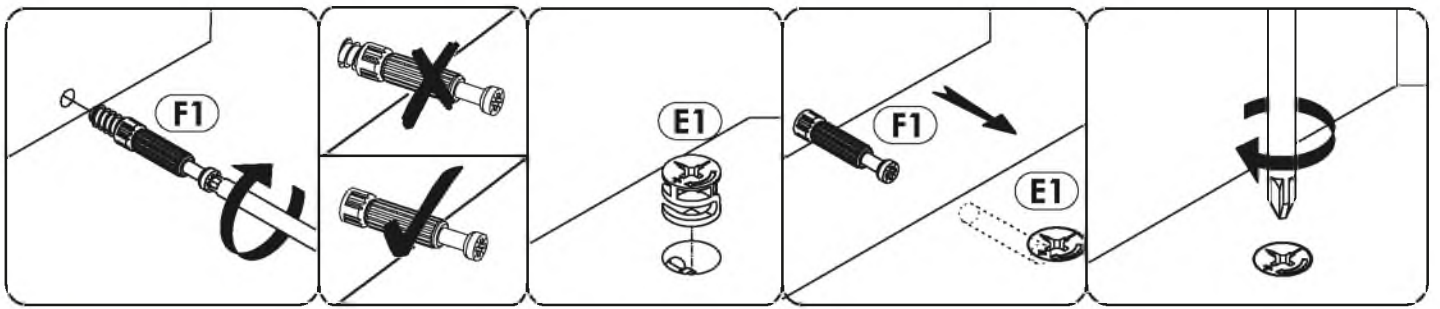

1	450	350	16	x1	1/2
2	450	350	16	x1	1/2
3	1943	330	16	x1	2/2
4	1943	330	16	x1	2/2
5	417	310	16	x1	1/2
6	1937	445	16	x1	2/2
7	416	295	16	x4	1/2
8	1957	431	3	x1	2/2

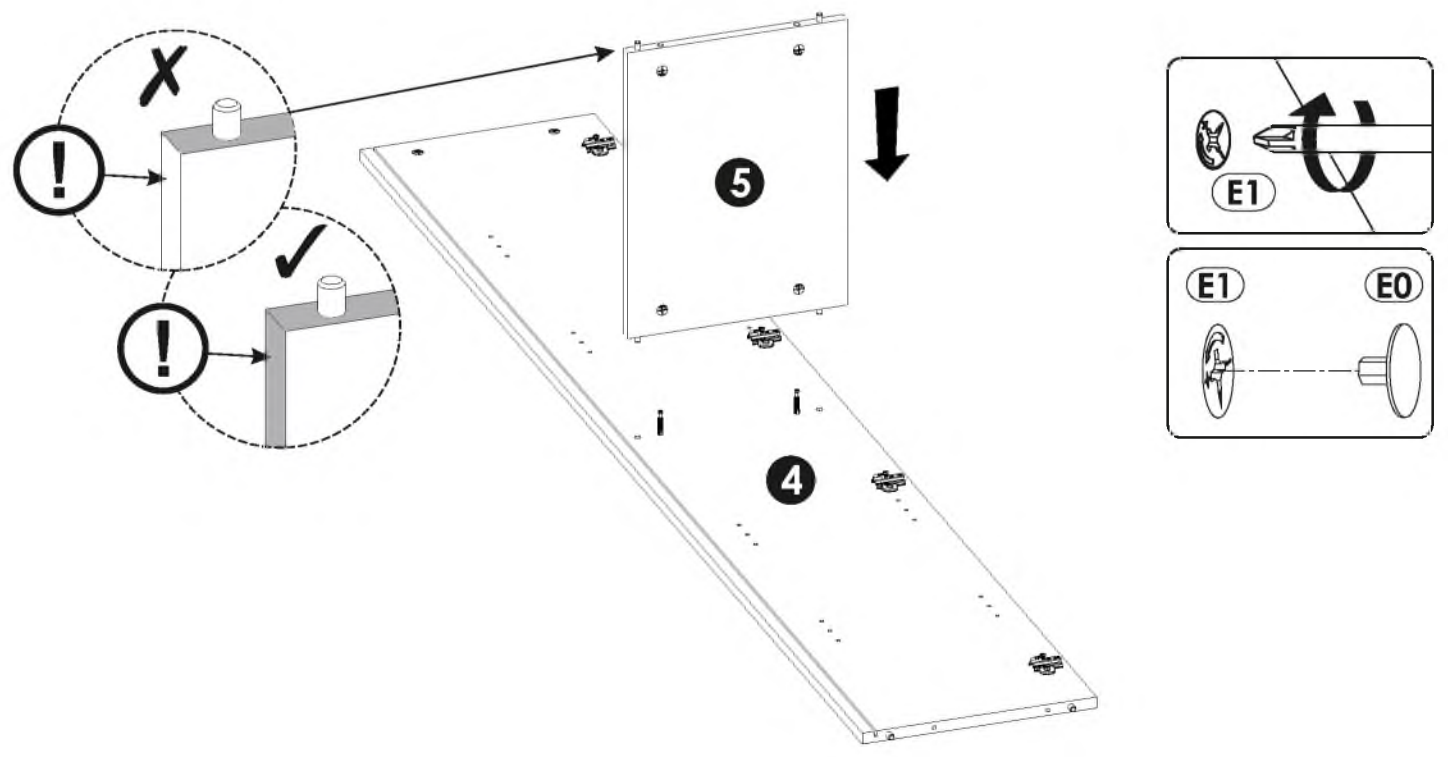
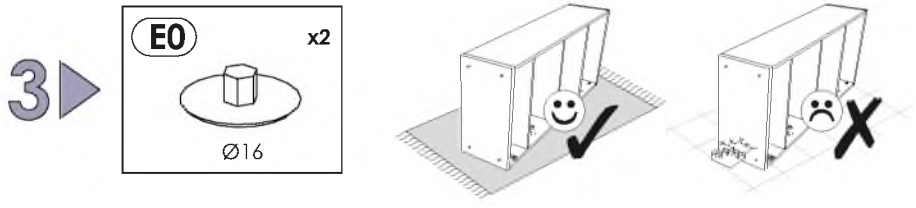
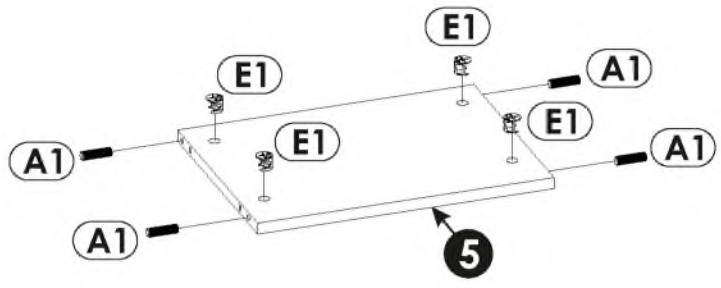
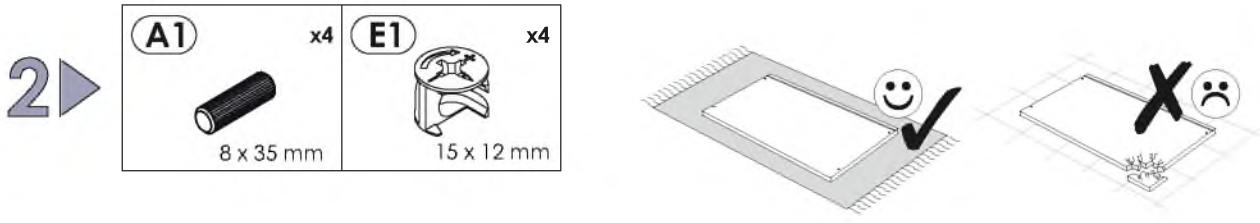



4 ▶

A1 x4  8 x 35 mm	E1 x2  15 x 12 mm	F1 x2  6 x 34 mm
---	--	---

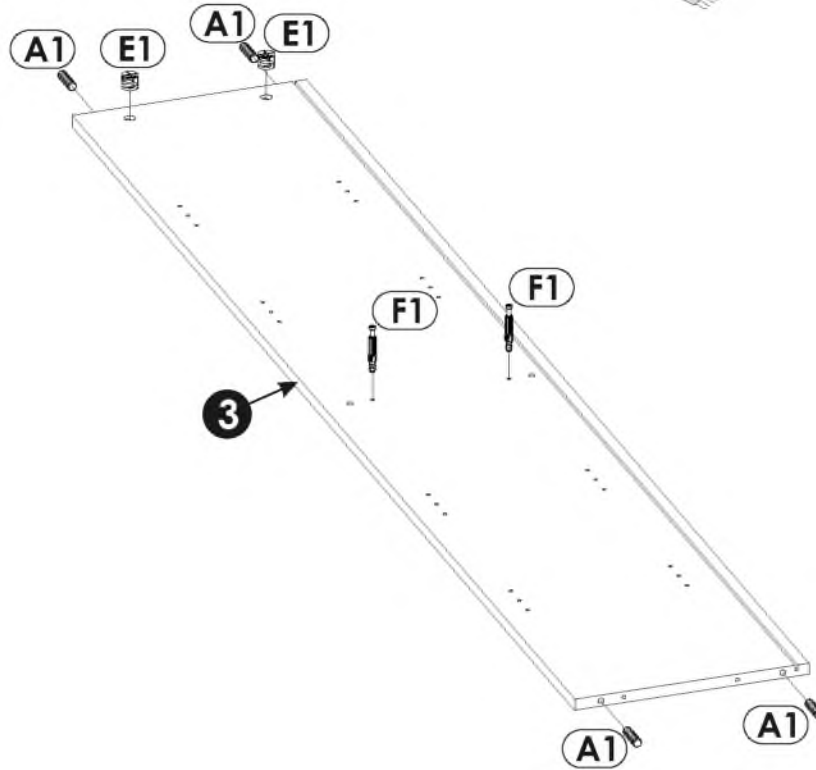

5 ▶

E0 x2  Ø16

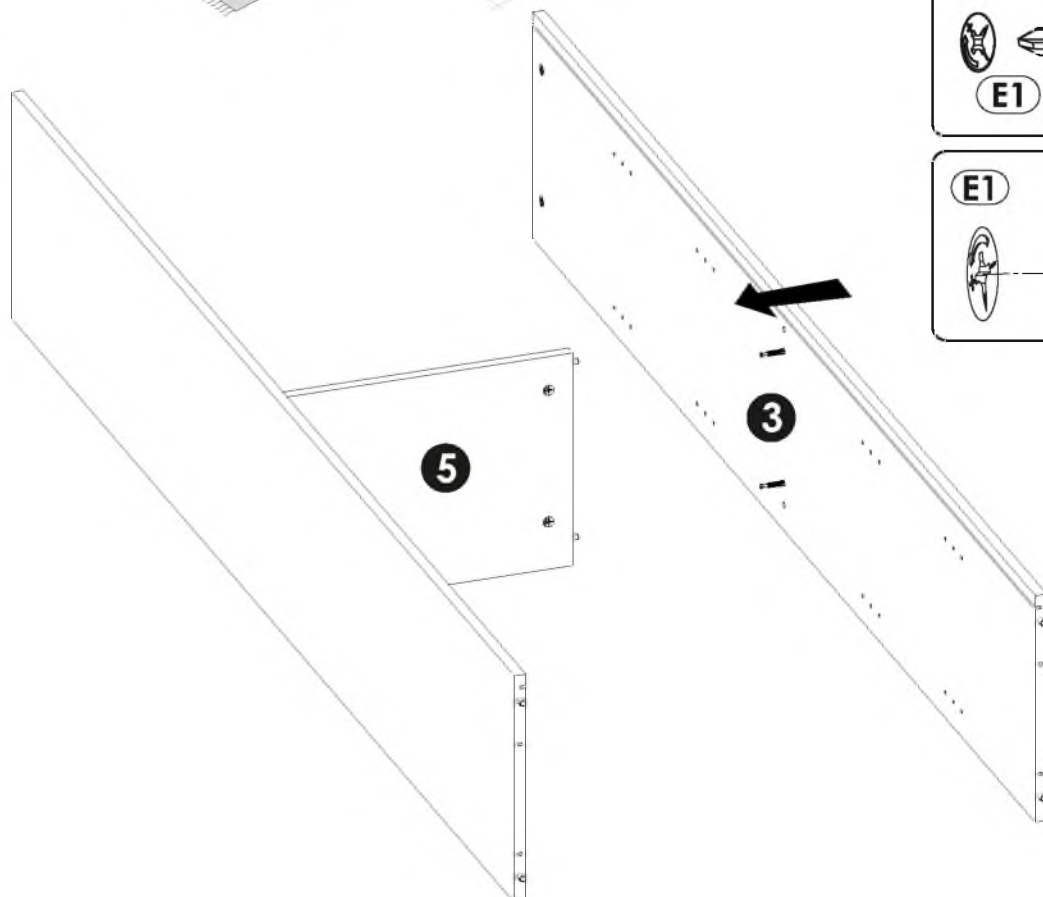
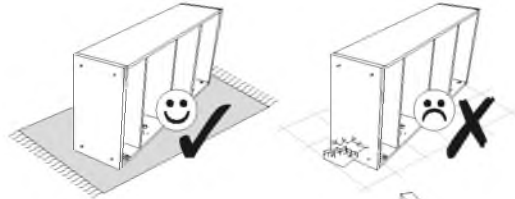

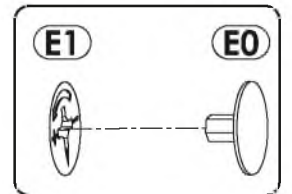
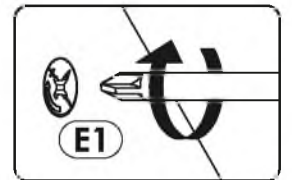
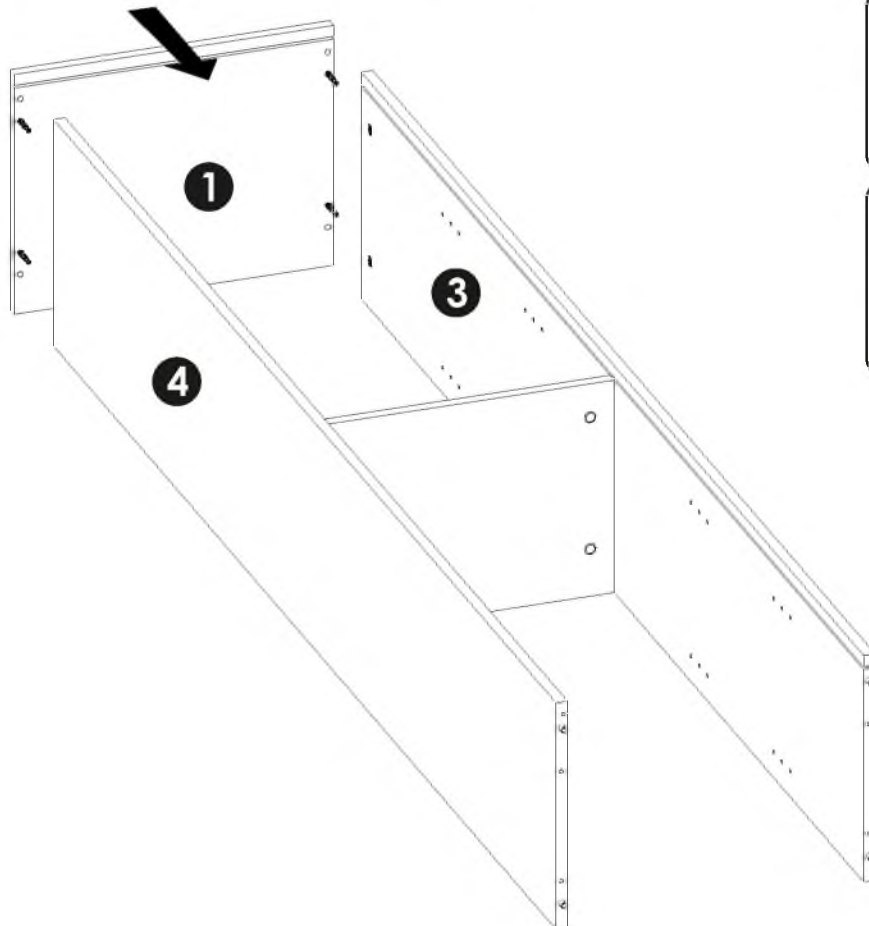
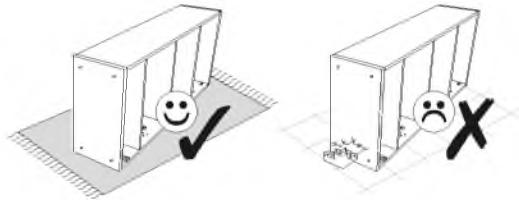
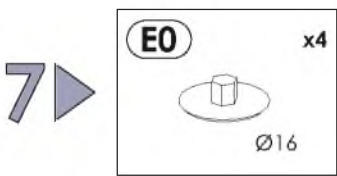
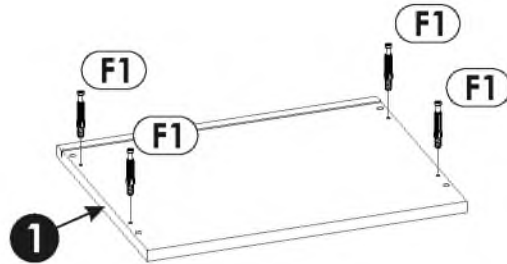
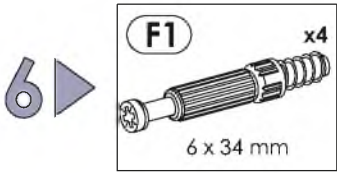

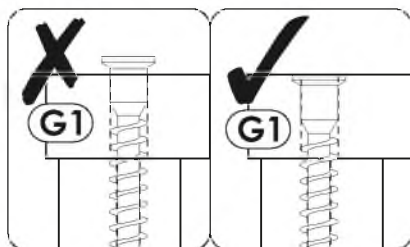
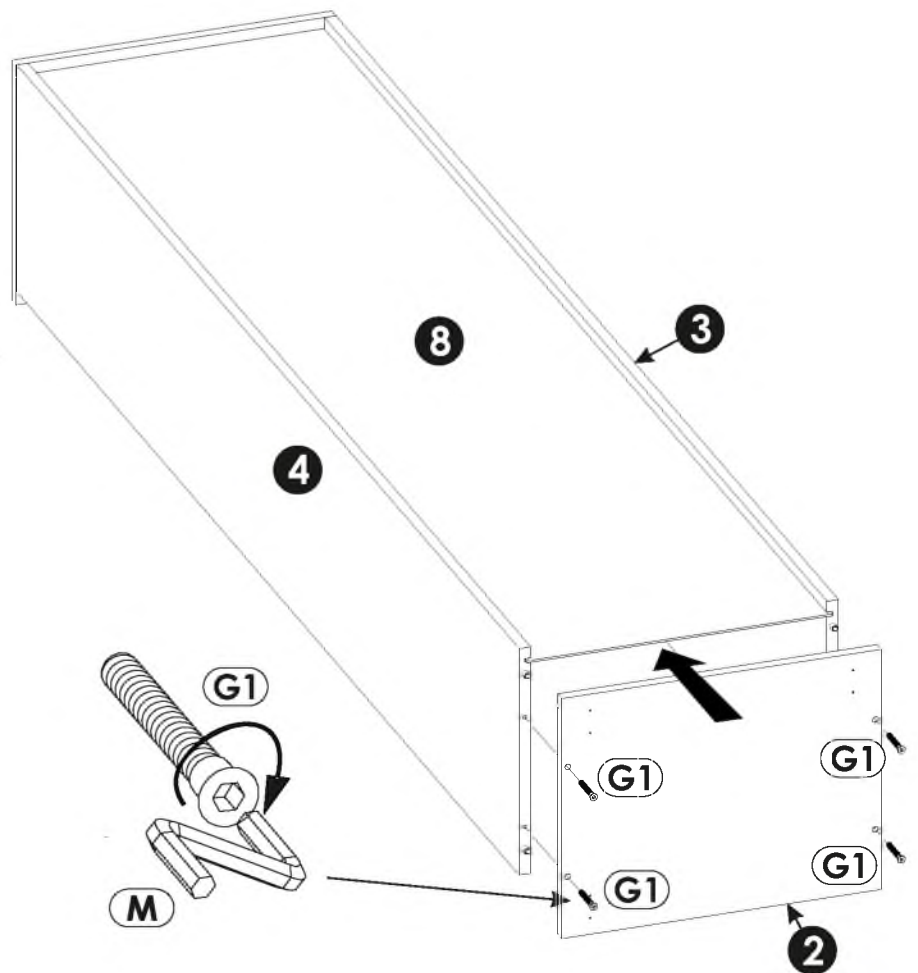
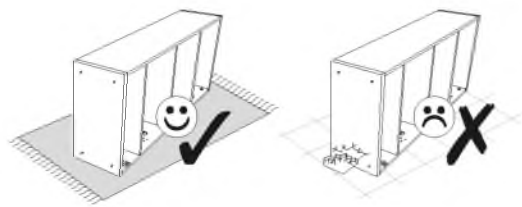
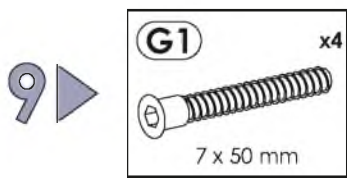
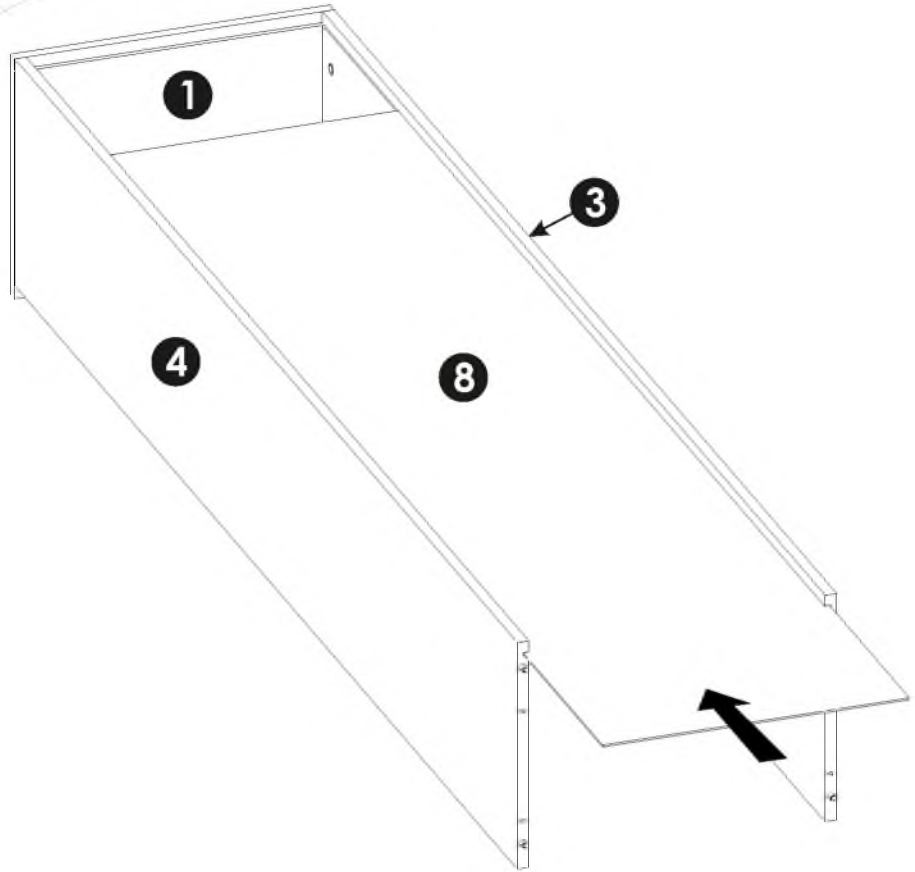
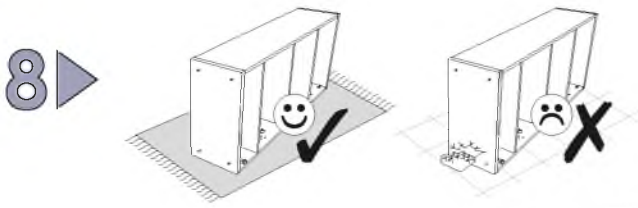

10 ▶

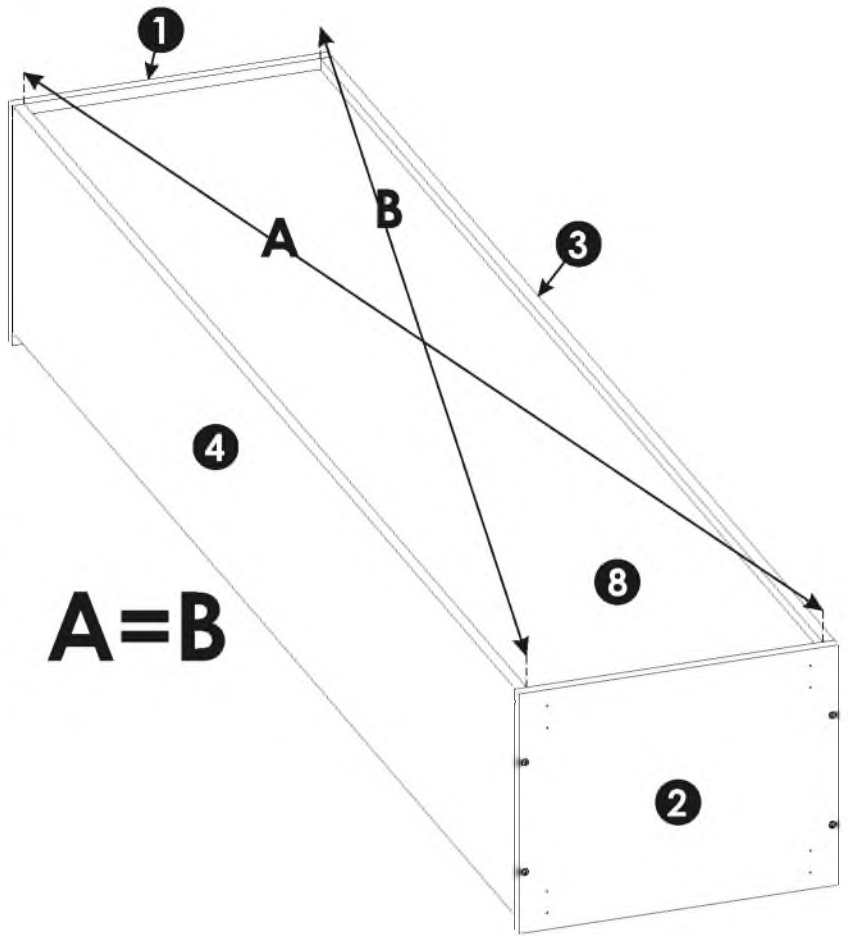
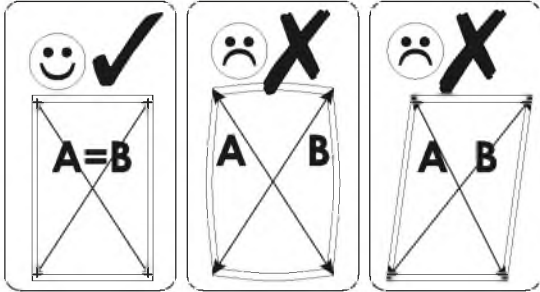
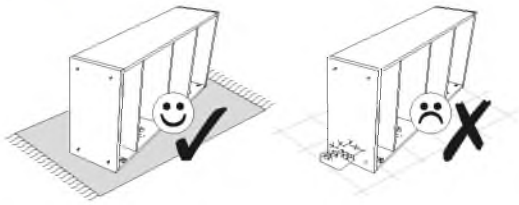

11 ▶

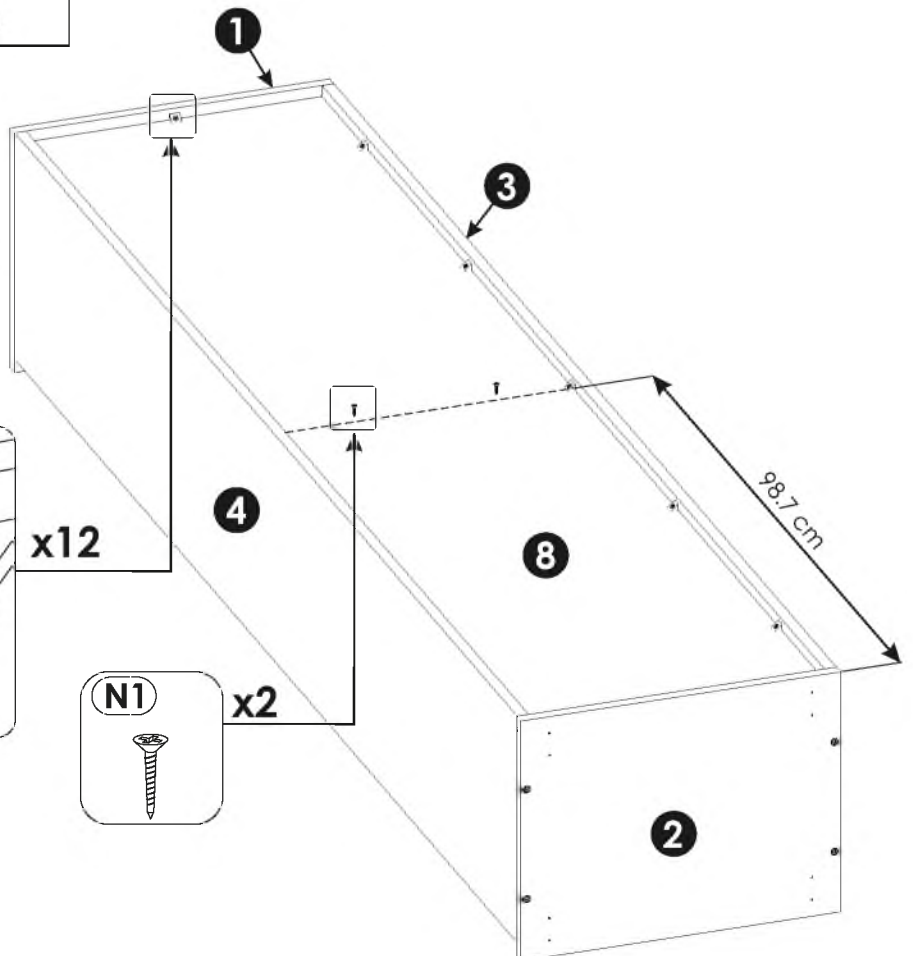
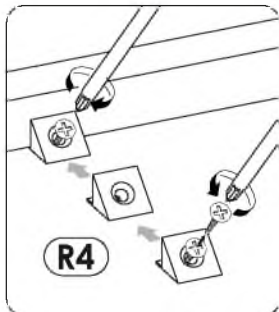
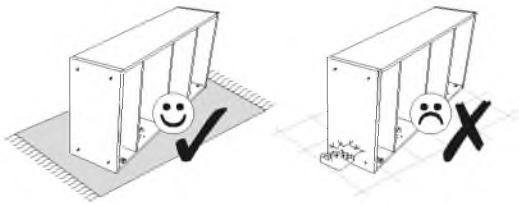
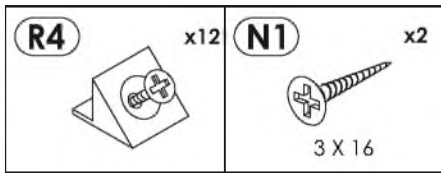

12 ▶

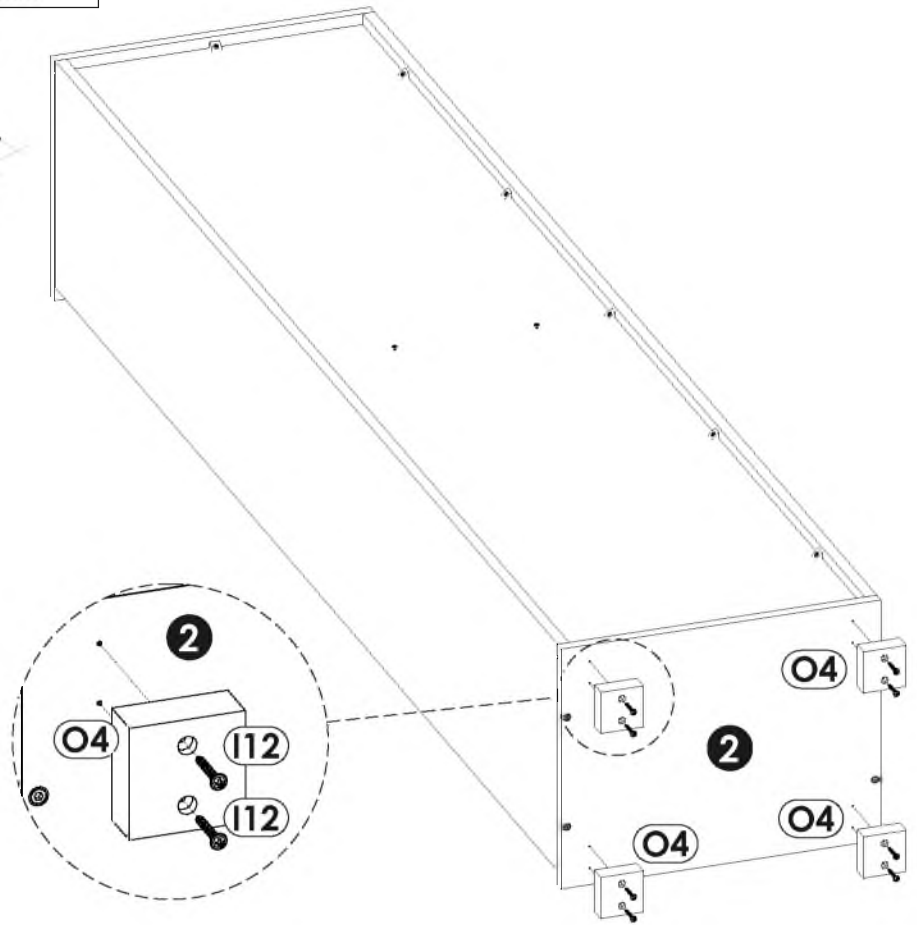
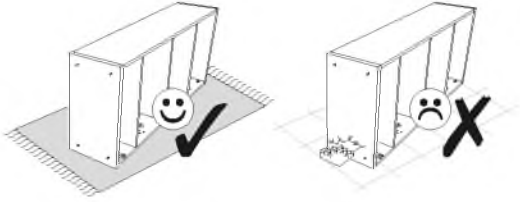
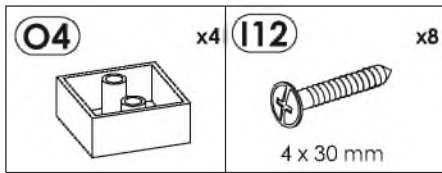

13 ▶

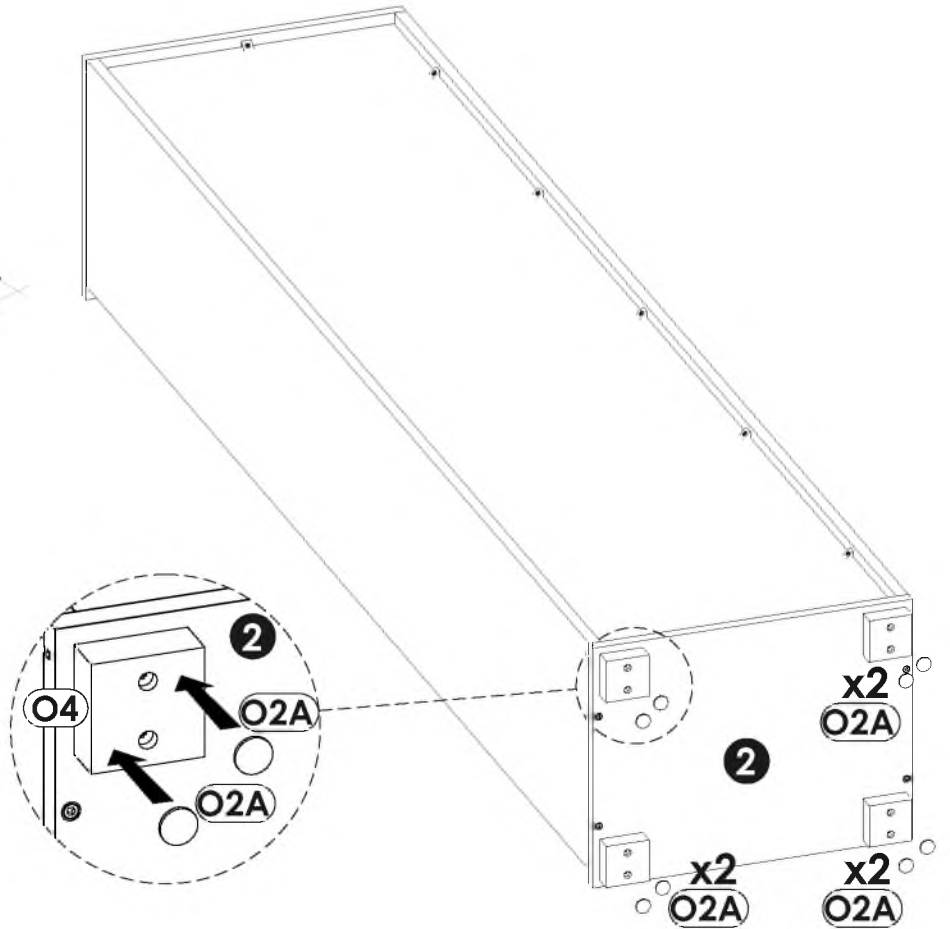
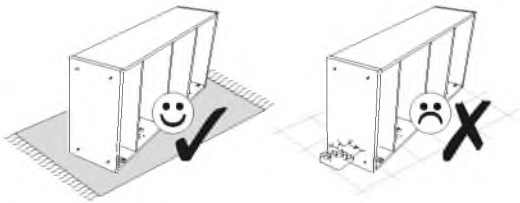
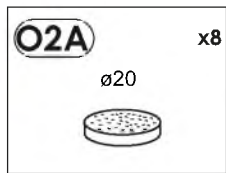

14 ▶

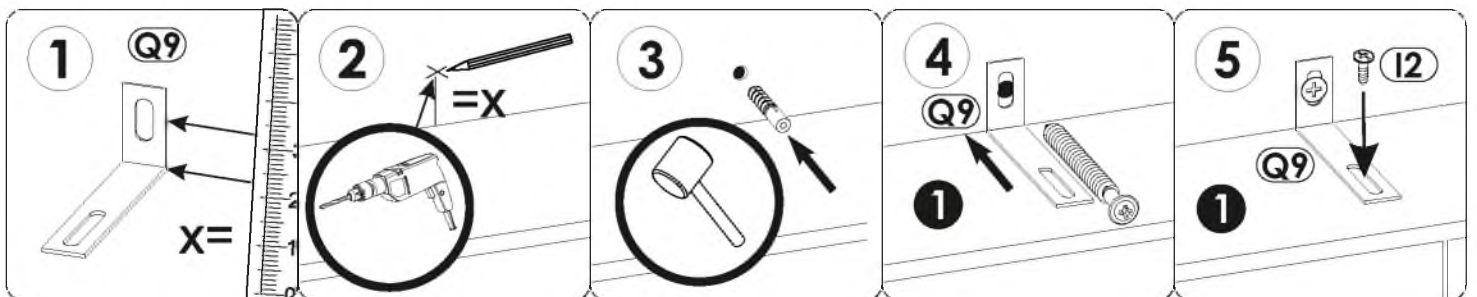
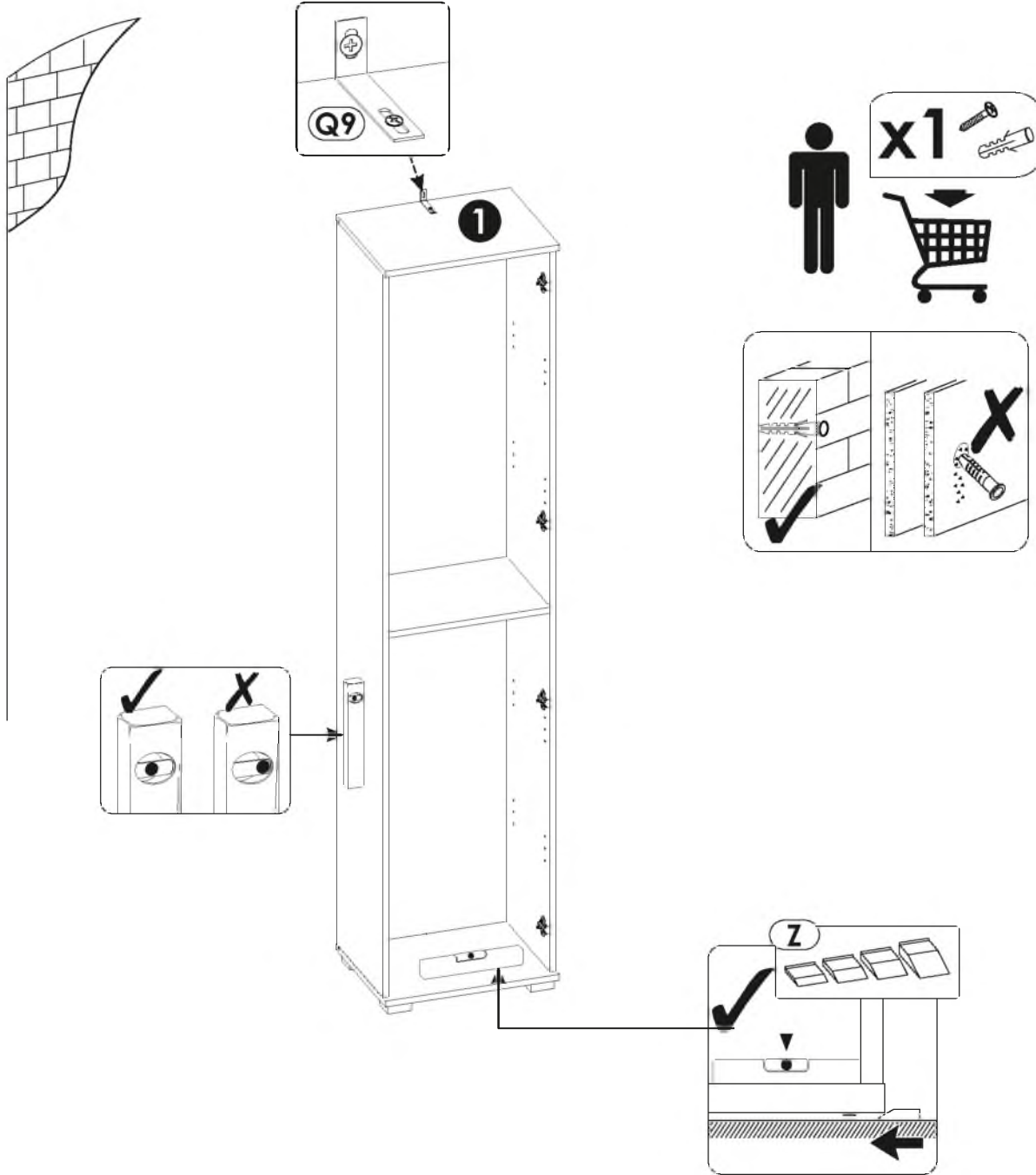
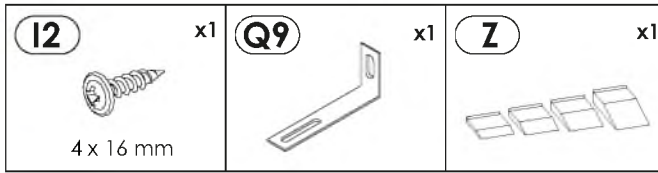

15 ▶

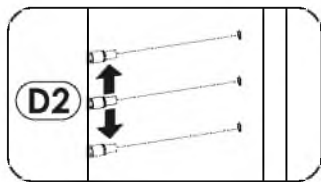
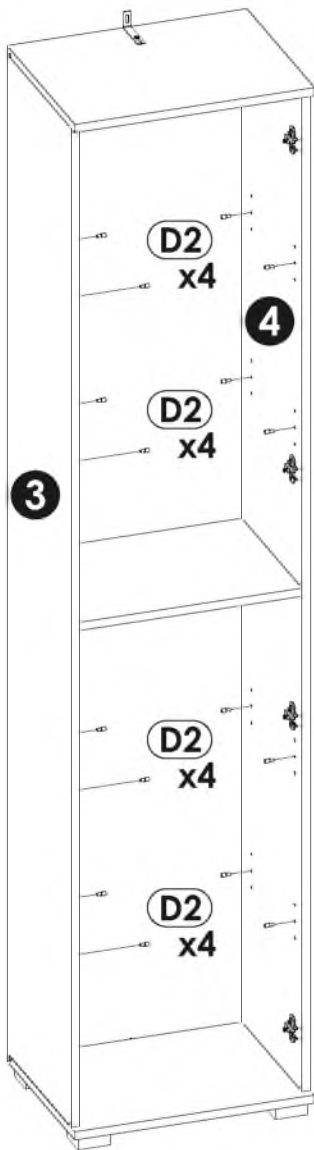
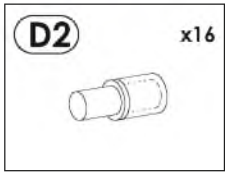

16 ▶

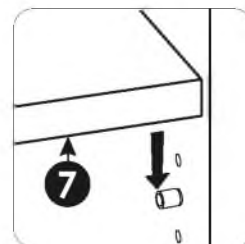
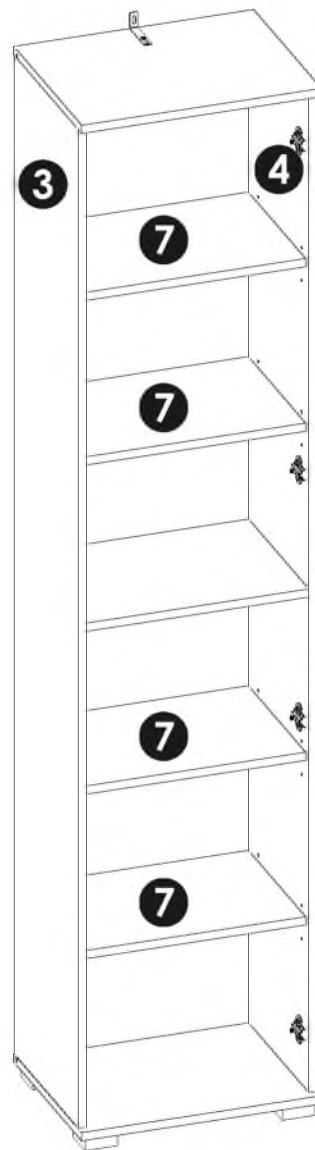

17 ▶

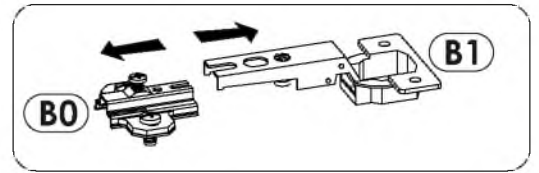

B1 x4	C2 x8 5 x 13 mm	R8 x3
--------------	---------------------------	--------------

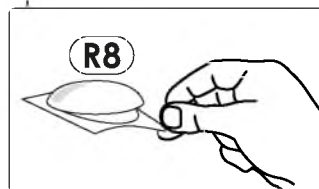
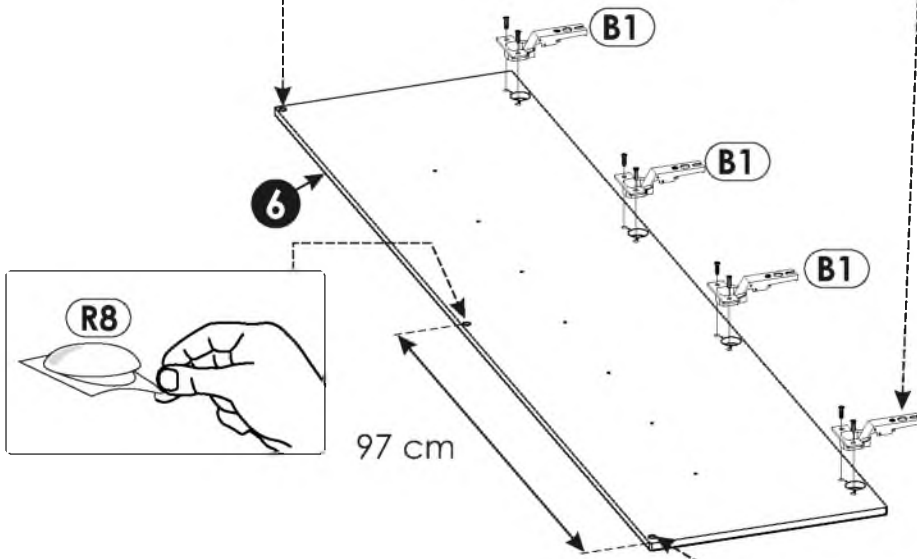
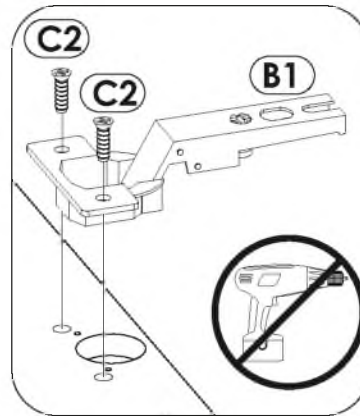
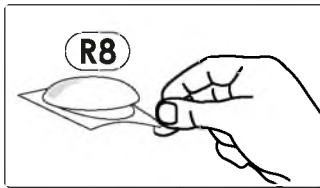

18▶



19 ▶

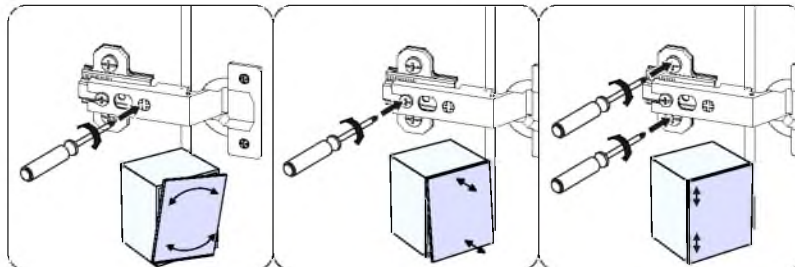
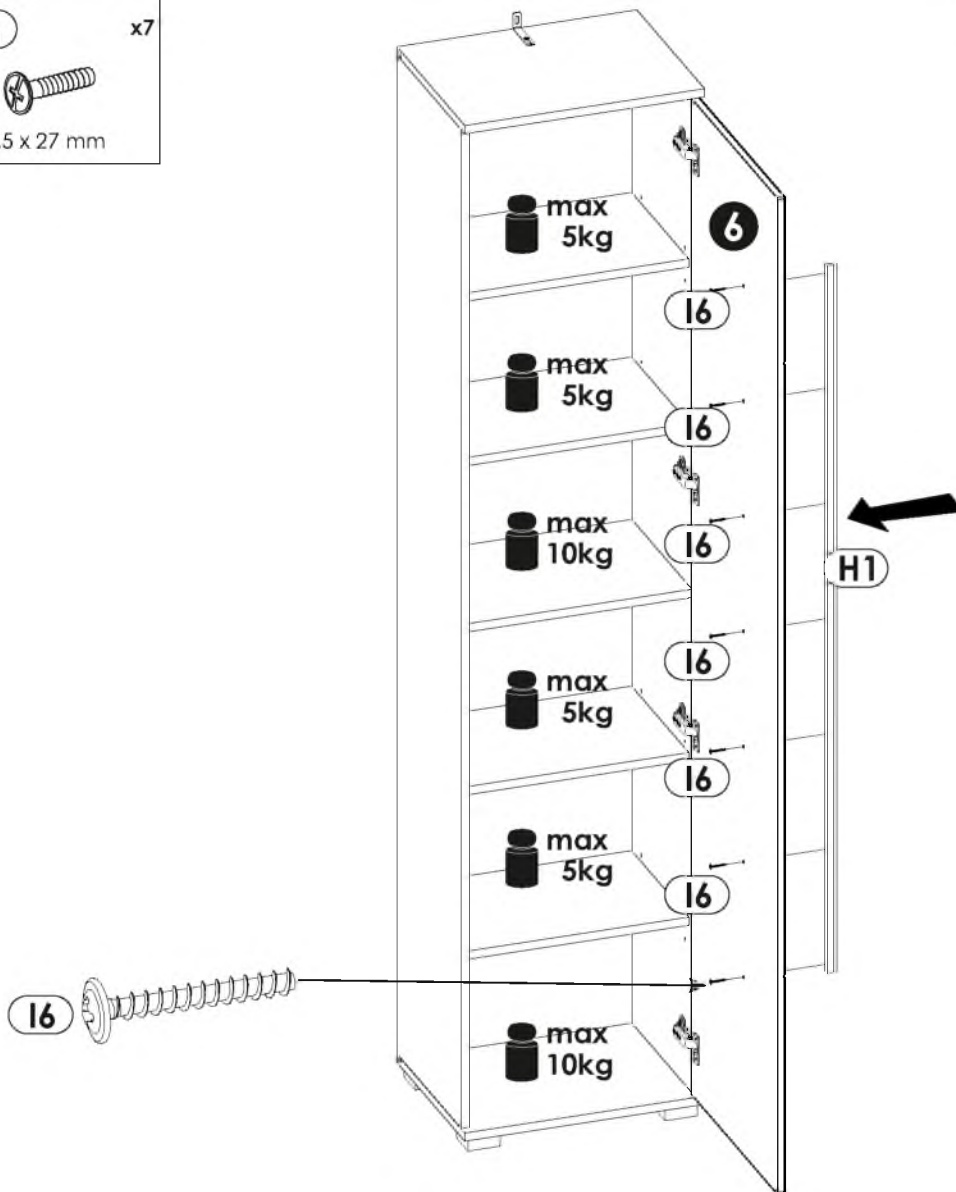
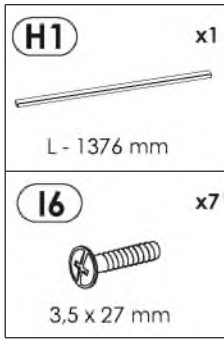

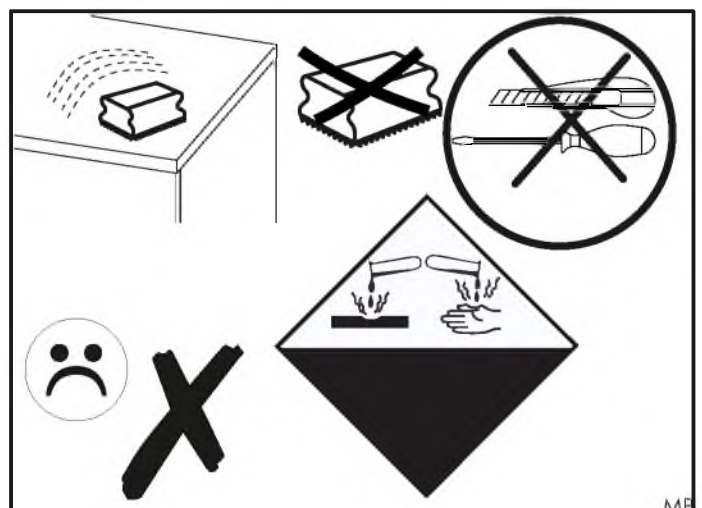
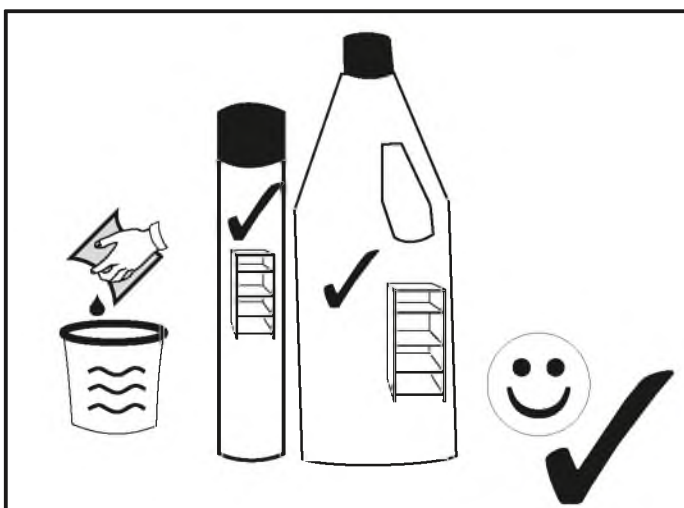
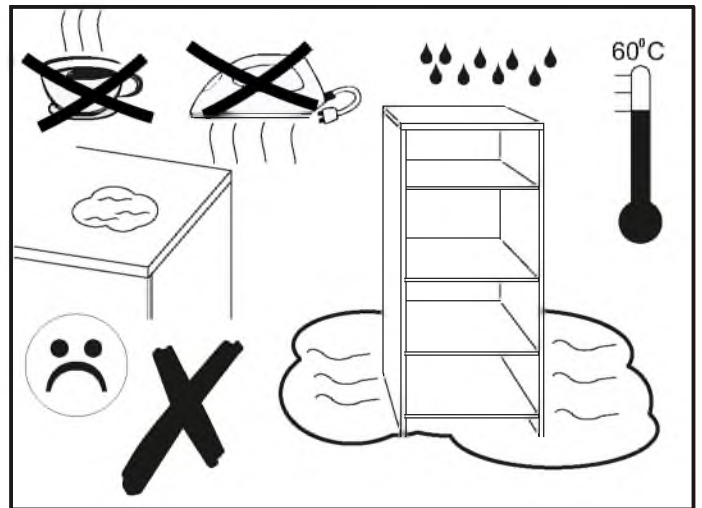
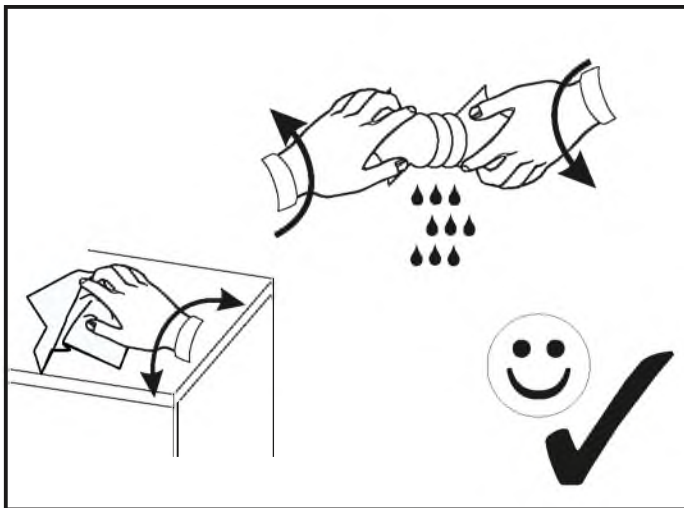
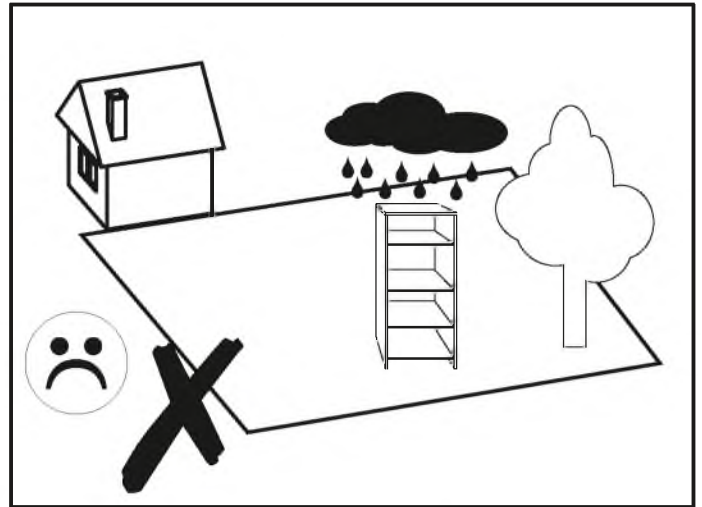
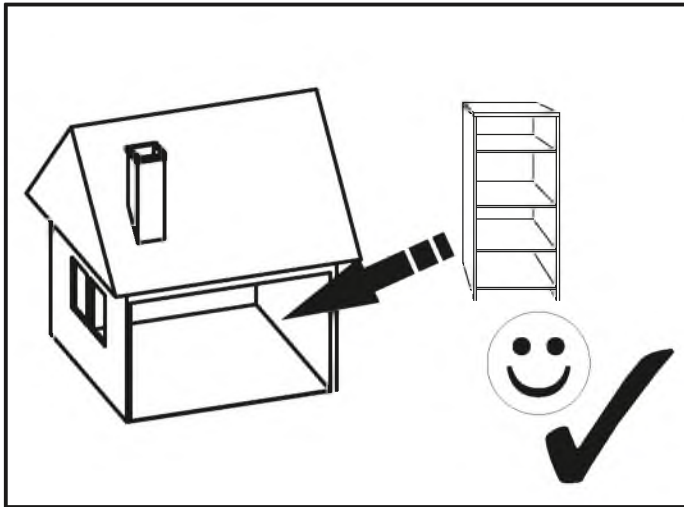

BWiX9078

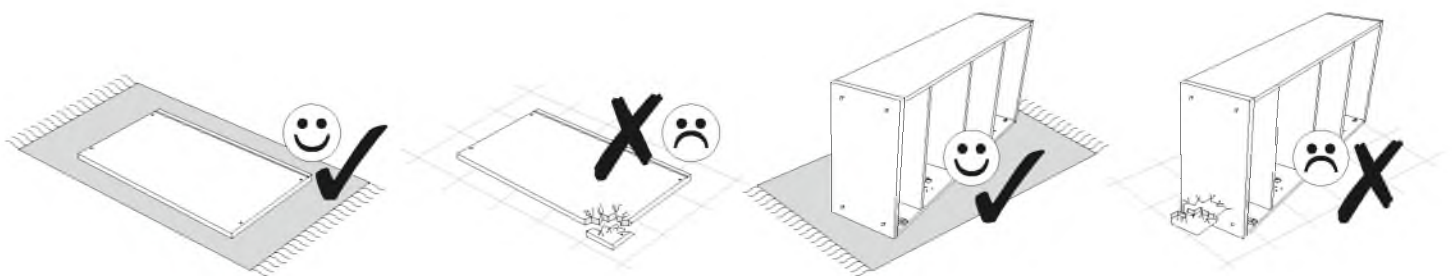
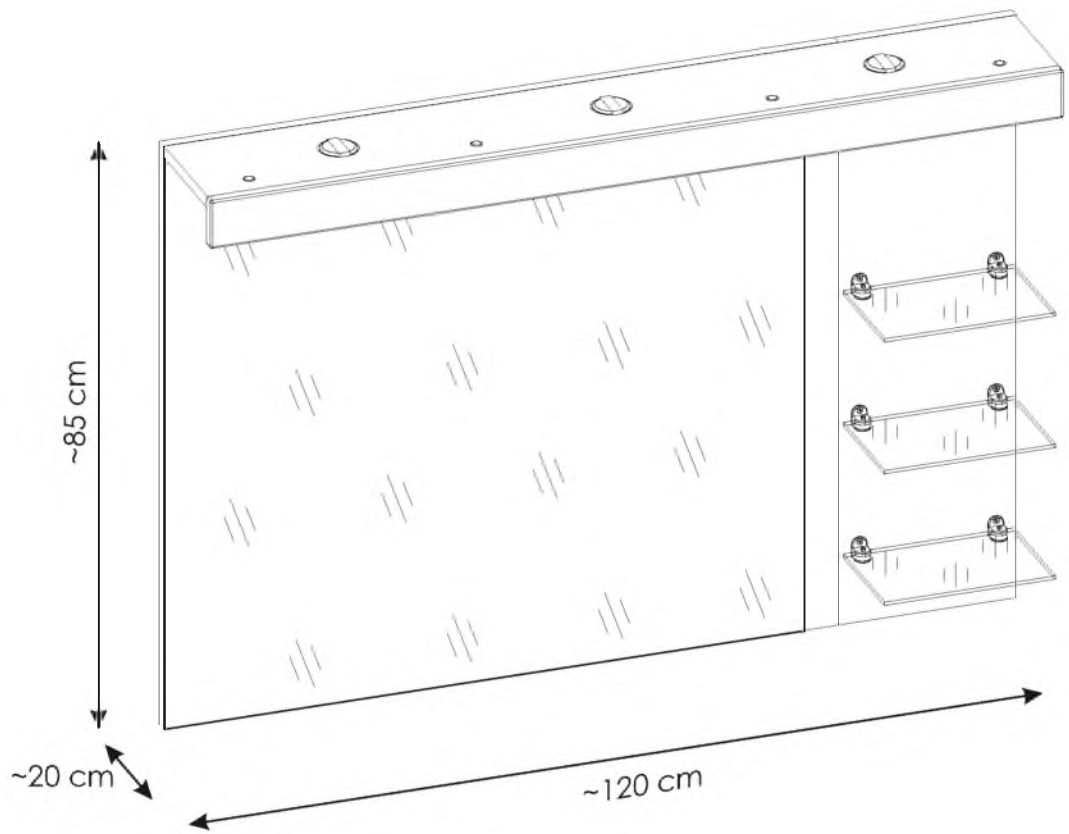
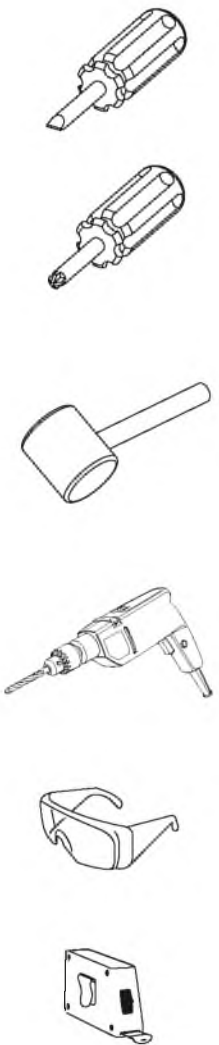
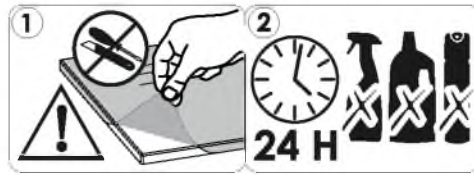

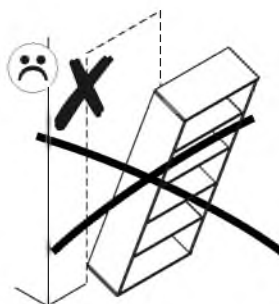
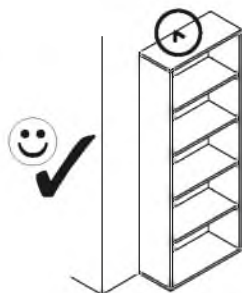

PL.

UWAGA! Mebel należy trwale zamocować do ściany, aby uniknąć ryzyka związanego z przewróceniem się mebla.

W paczce nie ma śrub mocujących, ponieważ rodzaj mocowania należy odpowiednio dobrać do rodzaju ściany. Dobierz właściwe do Twojego rodzaju ściany.

D.

ACHTUNG! Um alle mit dem Umkippen des Möbels verbundenen Risiken auszuschließen, muss das Möbel fest an der Wand verankert werden. Beschläge für die Wandbefestigung sind nicht beige packt, da diese von der jeweiligen Wandbeschaffenheit abhängig sind. Bitte solche Befestigungsschläge wählen, die für die heimischen Wände geeignet sind.

FR.

ATTENTION! Ce meuble doit être fixé en permanence au mur pour éviter les risques de chute. Les vis de fixation ne sont pas livrées car le type de fixation doit être choisi en fonction du type de mur. Sélectionnez les fixations adaptées au mur.

I.

ATTENZIONE! Il mobile deve essere permanentemente fissato alla parete per evitare i rischi derivanti da un ribaltamento del mobile. La confezione non include le viti di fissaggio, in quanto il tipo di fissaggio deve essere scelto in base al tipo di parete. Utilizzare viti appropriate in base al materiale della parete.

HR.

NAPOMENA! Namještaj mora biti trajno pričvršćen za zid, kako bi se izbjegao rizik od njegovog prevrtanja. U paketu nema vijaka za pričvršćivanje, jer se vrsta montaže mora prilagoditi vrsti zida. Odaberite pravu vrstu prema Vašoj vrsti zida.

EN.

WARNING! To prevent this furniture from tripping over, fix it to the wall permanently. Fixing devices are not included since different wall materials require different types of fixing devices. Please make sure you chose the correct ones for your type of wall.

SK.

POZOR! Nábytok musí byť trvalo pripevnený k stene tak, aby sa zamedzilo riziku prevrátenia. Balík neobsahuje upevňovacie skrutky, pretože typ upevnenia je treba vybrať podľa typu steny. Vyberte typ vhodný pre Vašu stenu.

CZ.

POZOR! Nábytek je nutné pevně připevnit ke zdi, abychom se vyhnuli riziku spojenému s jeho převrnutím. Součástí balení nejsou připevňovací šrouby, protože způsob připevnění je nutné zvolit podle druhu stěny. Vyberte správný pro Váš typ stěny.

RU.

ПРИМЕЧАНИЕ! Эту мебель необходимо всегда прикреплять к стене, чтобы избежать рисков, связанных с переворотом мебели. В пакете нет крепежных винтов, потому что тип крепления должен быть выбран в соответствии с типом стены. Выберите, пожалуйста, правильные винты к вашей стене.

RO.

ATENȚIE! Mobila trebuie ancorată permanent în perete pentru a evita riscul de răsturnare a mobilei. În pachet nu sunt incluse șuruburile de fixare, deoarece tipul de ancoraj trebuie ales în funcție de tipul de perete. Alegeți șuruburile potrivite pentru tipul Dvs. de perete.

TR.

DİKKAT! Devrime riskini önlemek için mobilya duvara sabitlenmelidir. Sabitleme civataları pakete dahil değil, çünkü sabitleme teribatının tipi, duvara tipine uygun olarak seçilmelidir. Onu duvarınızın tipine göre seçiniz.

AR.

ملاحظة!

يجب تثبيت الأثاث بإحكام إلى الحائط أو الجدار لتجنب خطر إنقلابه. لا تحتوي اللعبة على مسامير التثبيت، إذ إنه ينبغي إستعمال المسامير المخصصة لنوعية الحائط أو الجدار. اختر المسامير التي تناسب جدارك.

E.

¡ATENCIÓN! El mueble debe ser fijado permanentemente a la pared para evitar el riesgo relacionado con el vuelco del mueble. En el paquete no hay tornillos de fijación, ya que se debe elegir el tipo de fijación adecuado para el tipo de pared. Elija el apropiado para su tipo de pared.

CN.

注意！本家具需要固定在墙上以免倒塌。箱子里没有安装螺钉。因为安装方式需要根据墙的类型调整。请按照您的墙类型选择合适的安装方式。

SLO.

POZOR! Pohišivo trajno pritrdite na steno, da preprečite tveganje, da se prevrne. V paketu ni pritrdilnih vijakov, saj je treba način pritrditve ustrezno izbrati glede na vrsto stene. Izberite način, ki je ustrezen za vašo steno.

HU.

FIGYELEM! Rögzítse a bútorokat a falhoz, hogy elkerülje a bútor felborulásának kockázatát. A készletben nem találhatóak rögzítőcsavarok, mivel a rögzítés típusa a fal típusától függ. Válassza ki a fal típusának megfelelő kötőelemeket.





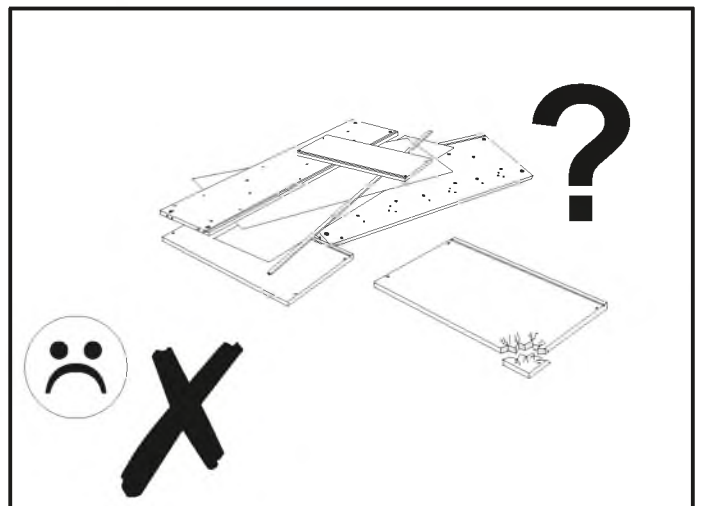
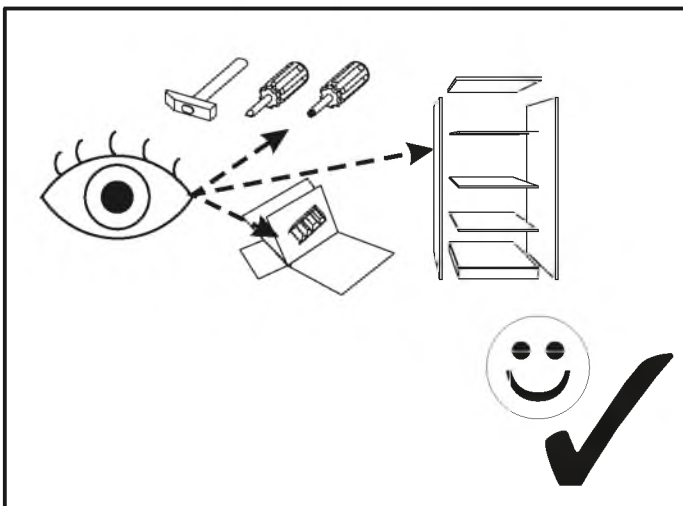
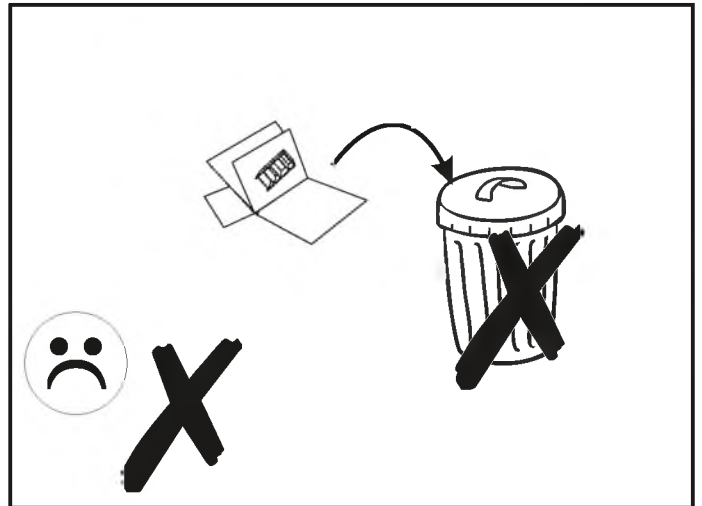
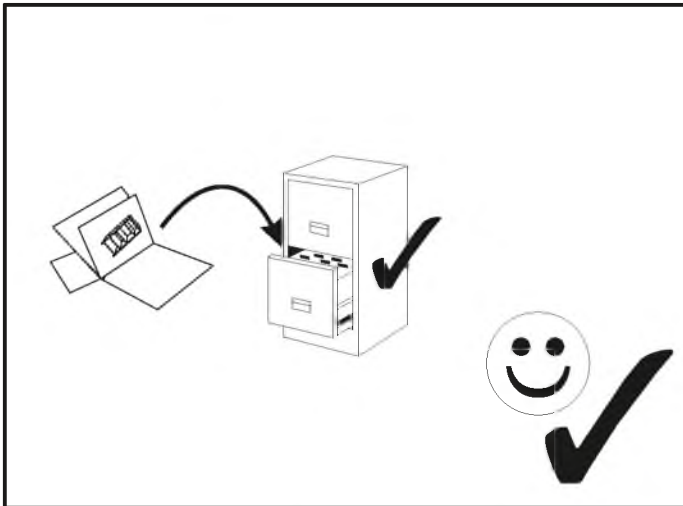
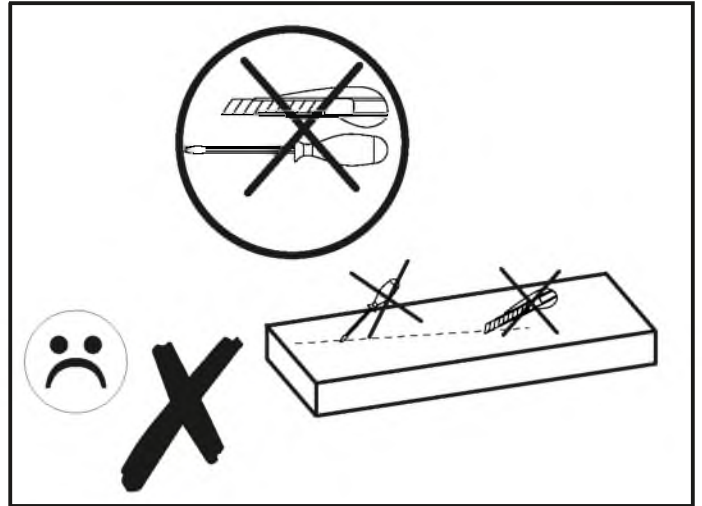
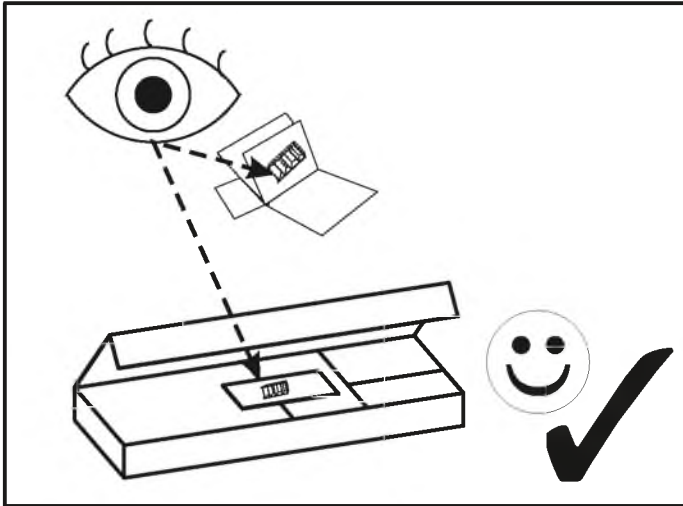



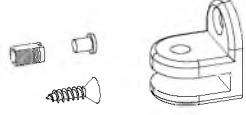

NL.

OPMERKING! De meubelen moeten permanent aan de muur worden bevestigd om te voorkomen dat de meubelen kantelen. Er zitten geen bevestigingsschroeven in het pakket, omdat het type bevestiging moet worden gekozen op basis van het type muur. Kies de juiste voor uw type muur.

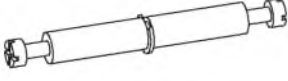

BWiX9078

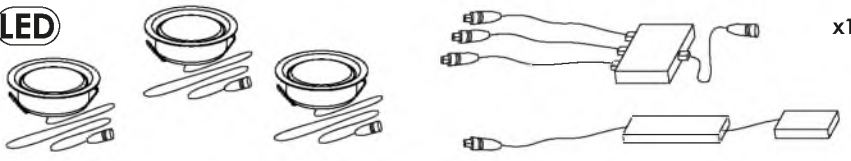
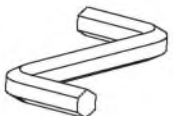
MM

<p>A1 8 x 35 mm x8</p> 	<p>A2 8 x 45 mm x4</p> 	<p>C2 5 x 13 mm x8</p> 
<p>D7 x6</p> 	<p>E0 Ø16 x4</p> 	<p>E1 15 x 12 mm x12</p> 
<p>F1 6 x 34 mm x4</p> 	<p>F3 7 x 58 mm x4</p> 	<p>G2 7 x 60 mm x4</p> 
<p>J11 4 x 16 mm x6</p> 	<p>LED x1</p> 	
<p>M x1</p> 	<p>P1 x4</p> 	<p>R7 x2</p> 

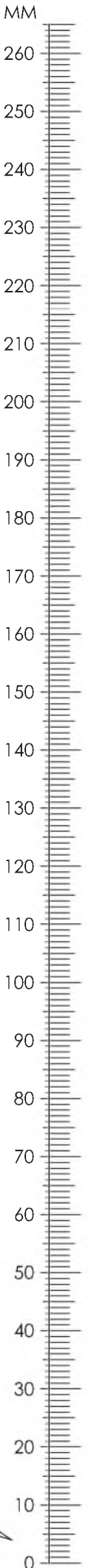
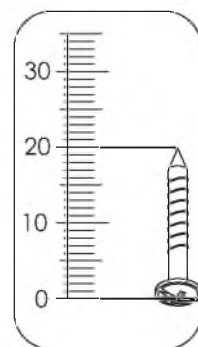

BWiX9078

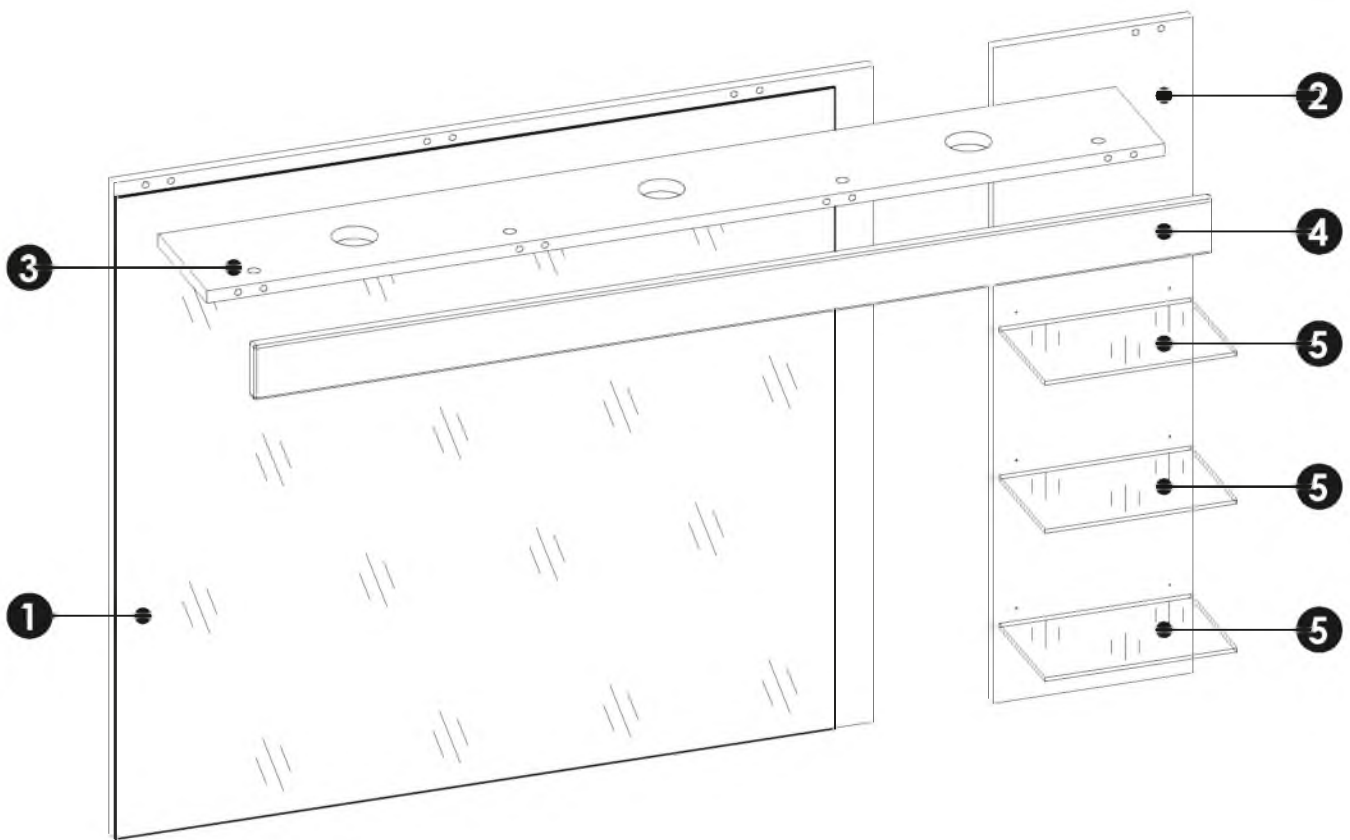
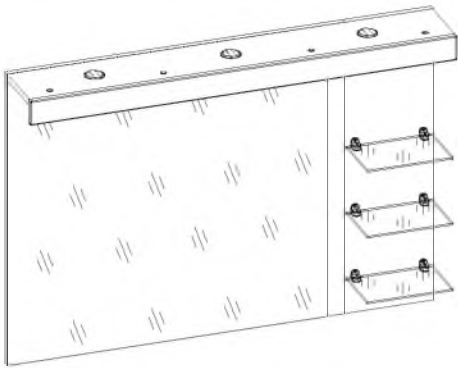

1	950	850	20	x1	1/1
2	850	250	16	x1	1/1
3	1198	168	16	x1	1/1
4	1200	70	16	x1	1/1
5	240	160	5	x3	1/1

1 ▶

C2 5 x 13 mm x4	E1 15 x 12 mm x4	P1 x2	R7 x1
------------------------------	-------------------------------	-----------------	-----------------

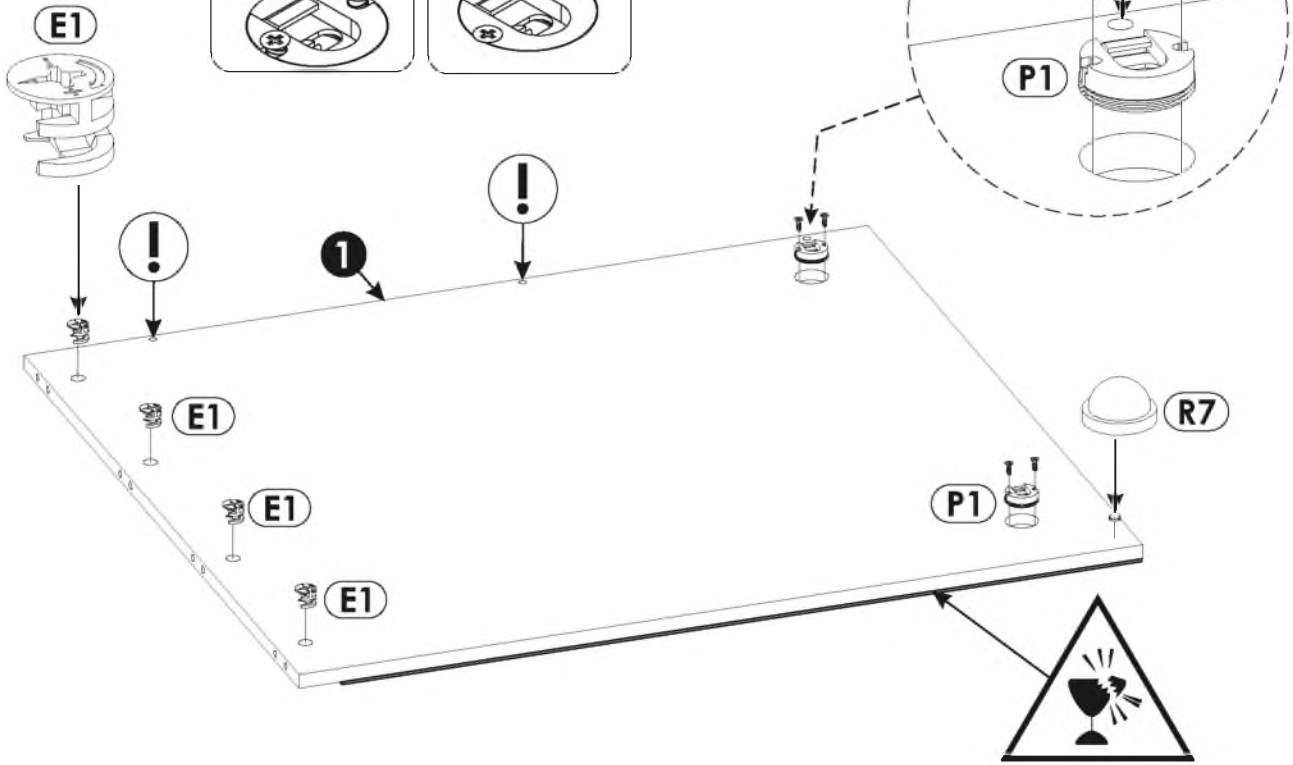
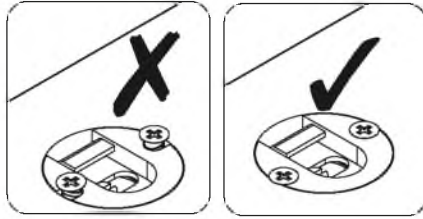
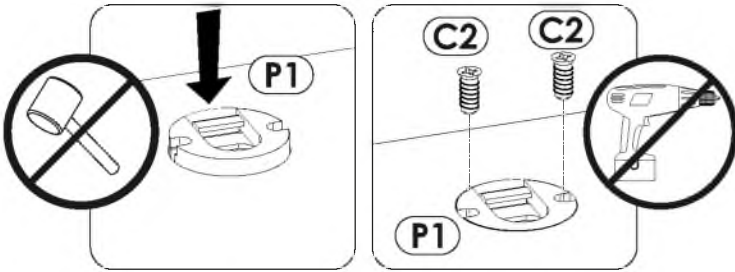

2 ▶

C2 5 x 13 mm x4	E1 15 x 12 mm x4	P1 x2	R7 x1
------------------------------	-------------------------------	-----------------	-----------------

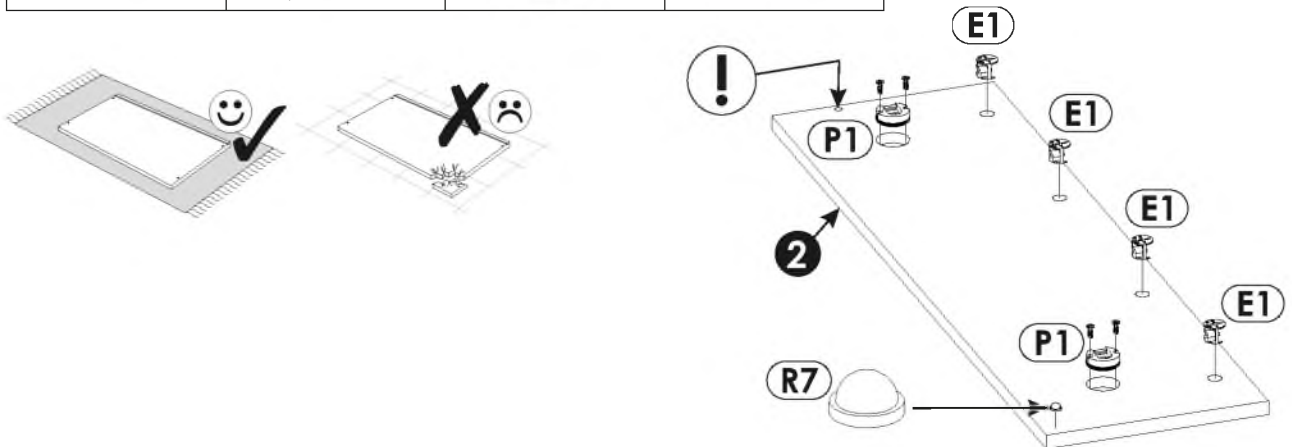

3 ▶

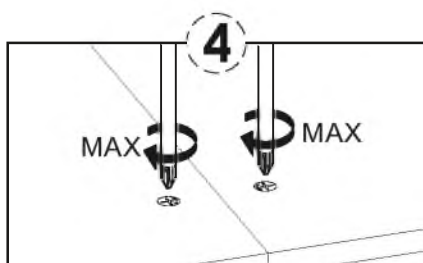
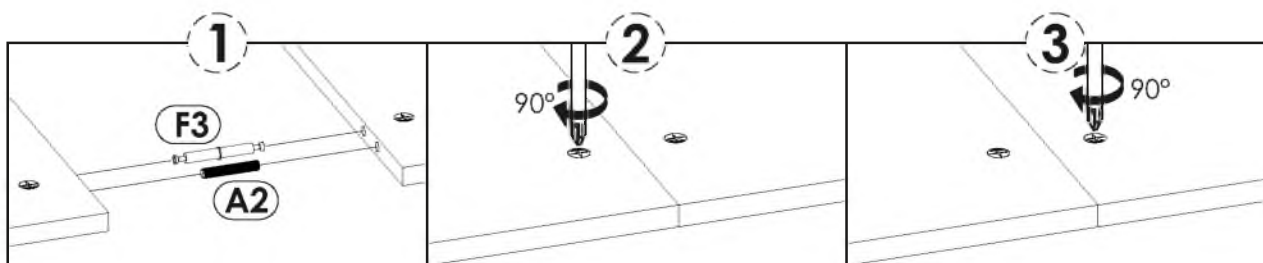
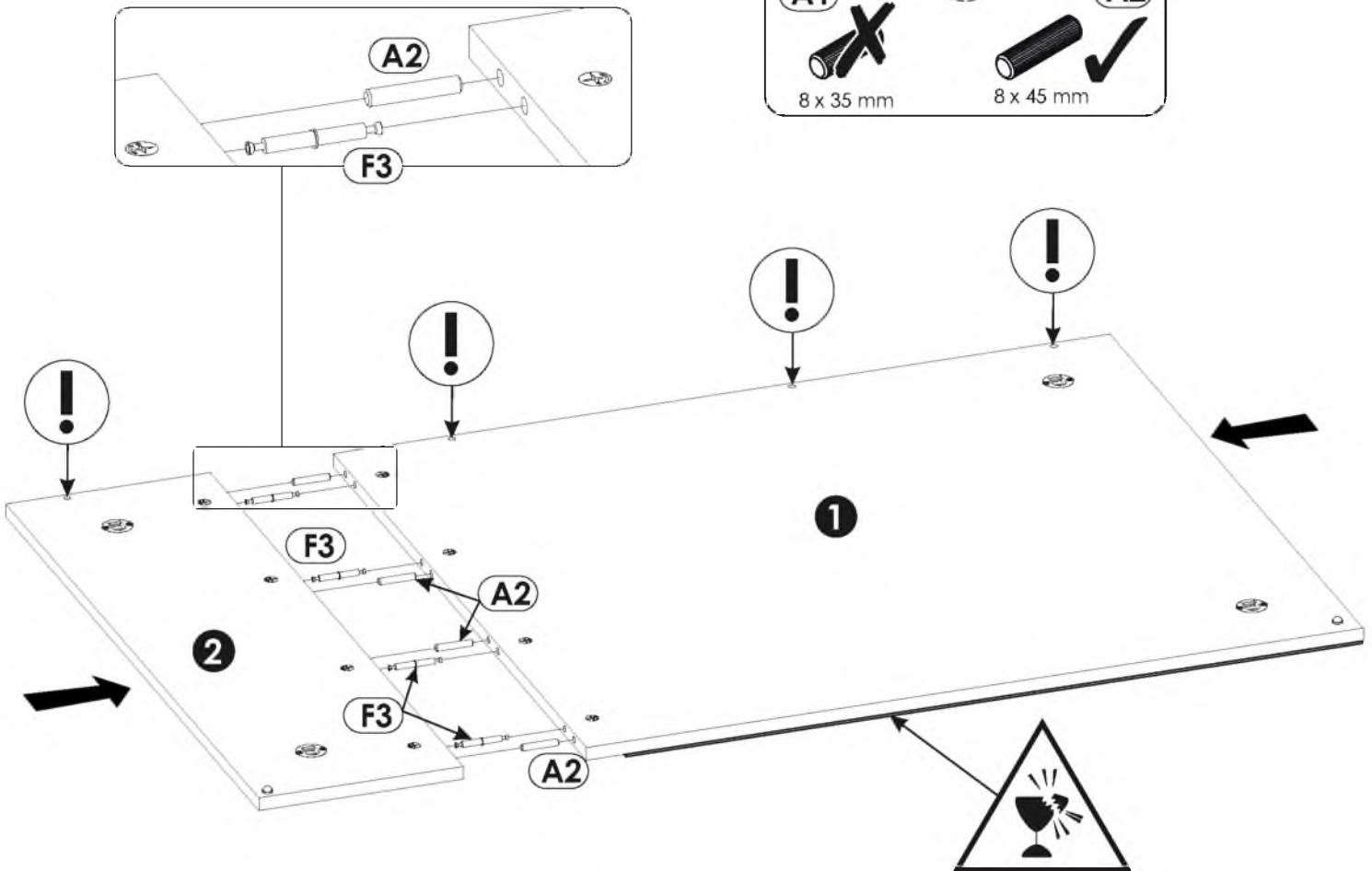
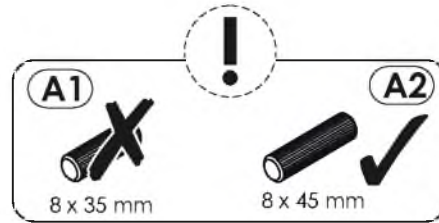
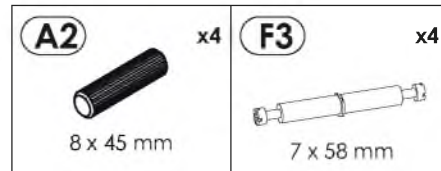
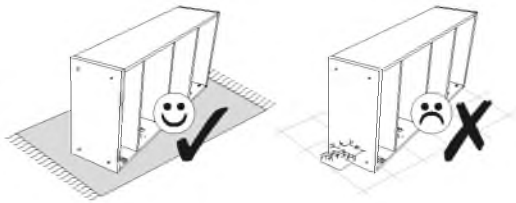

4 ▶

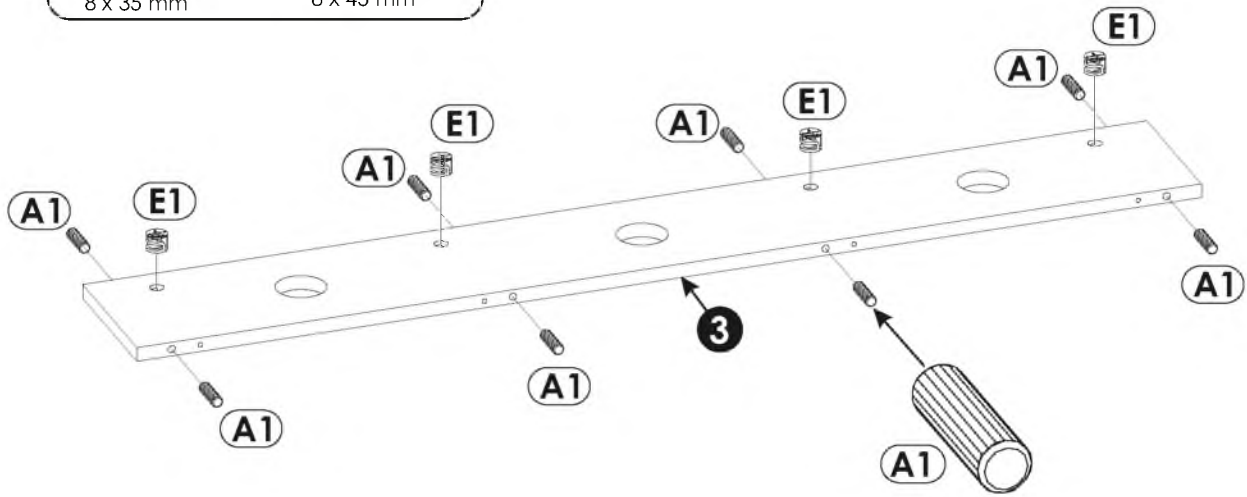
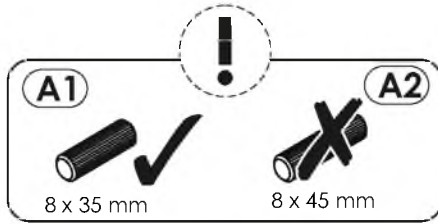
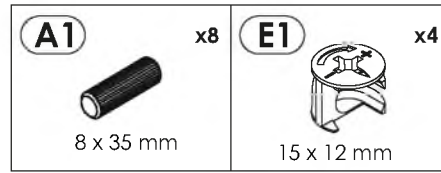
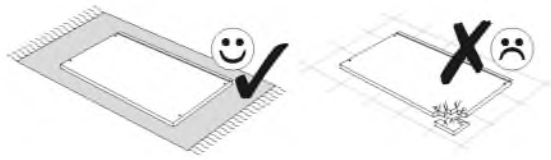

5 ▶

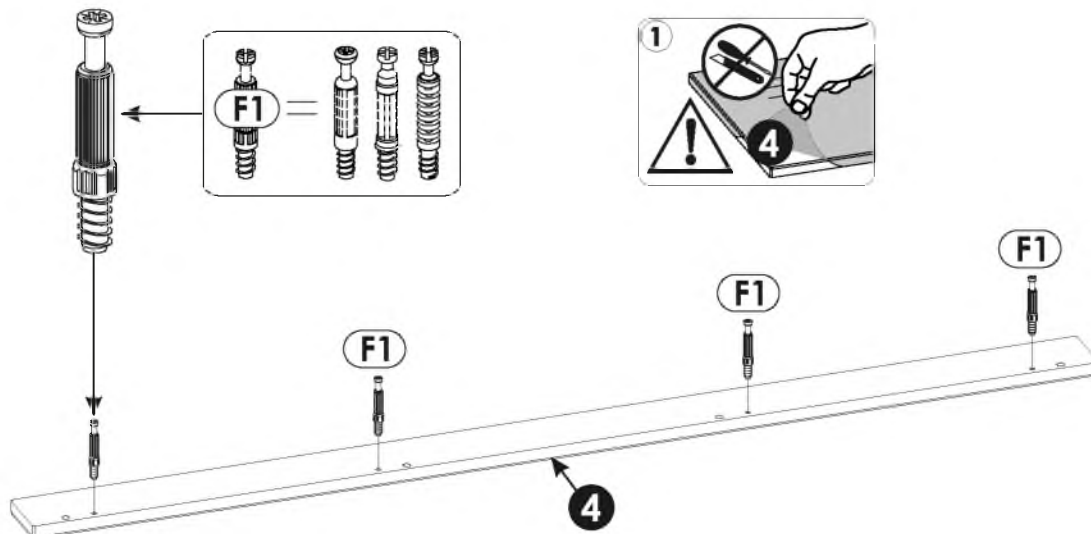
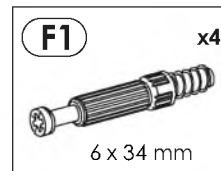

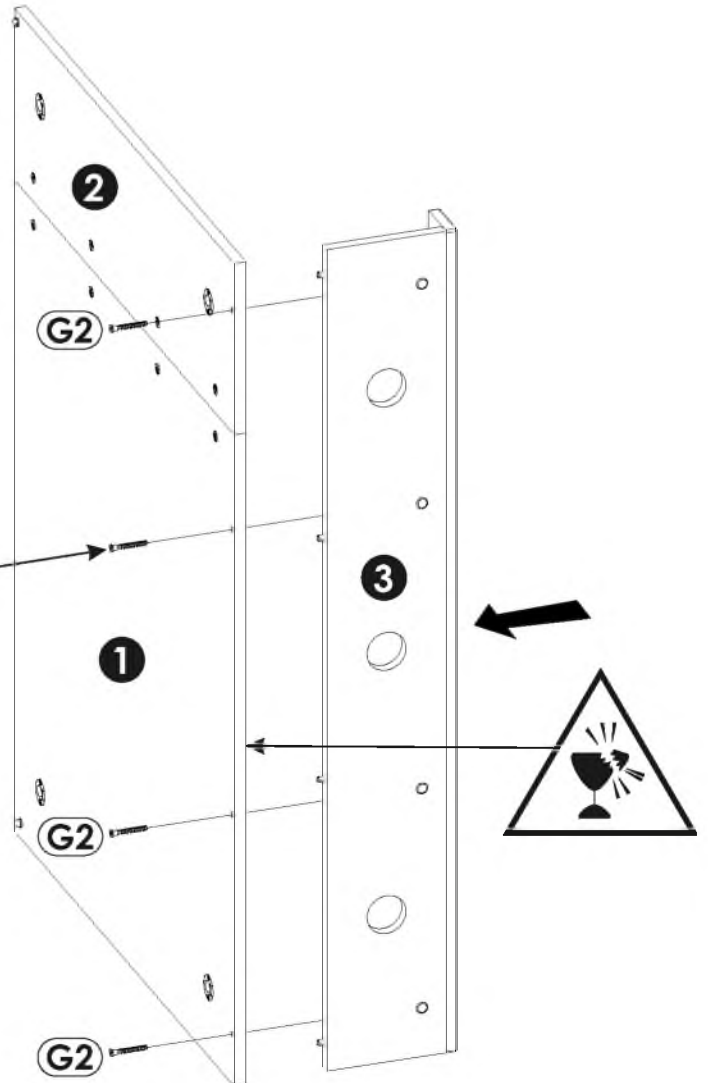
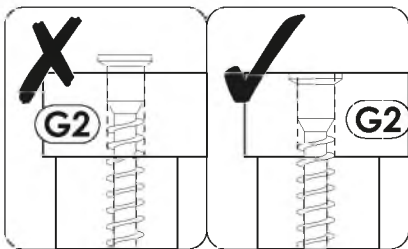
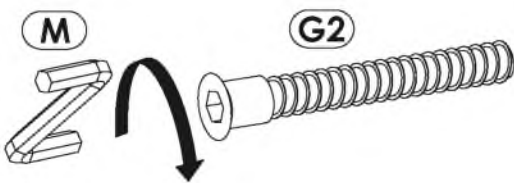
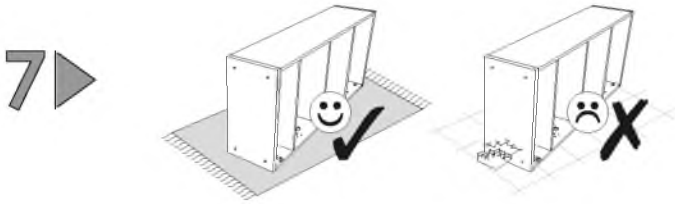
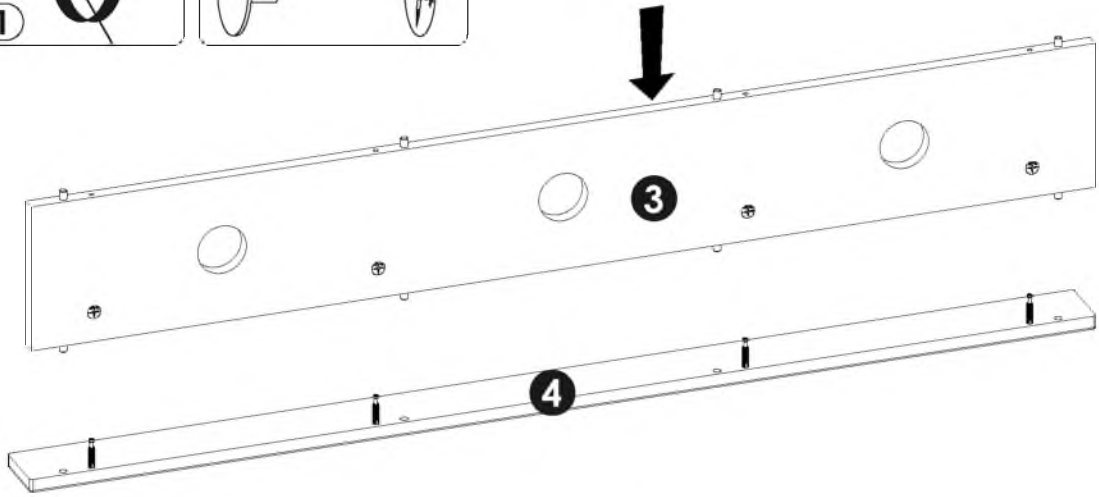
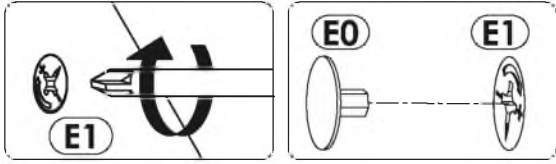
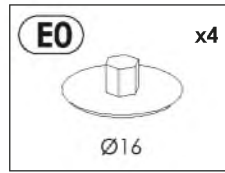
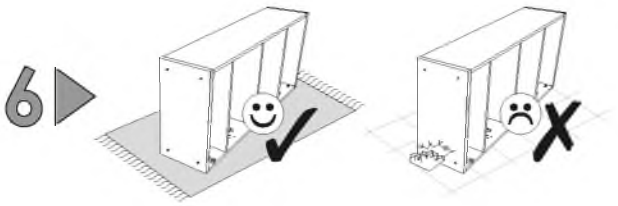

8 ▶

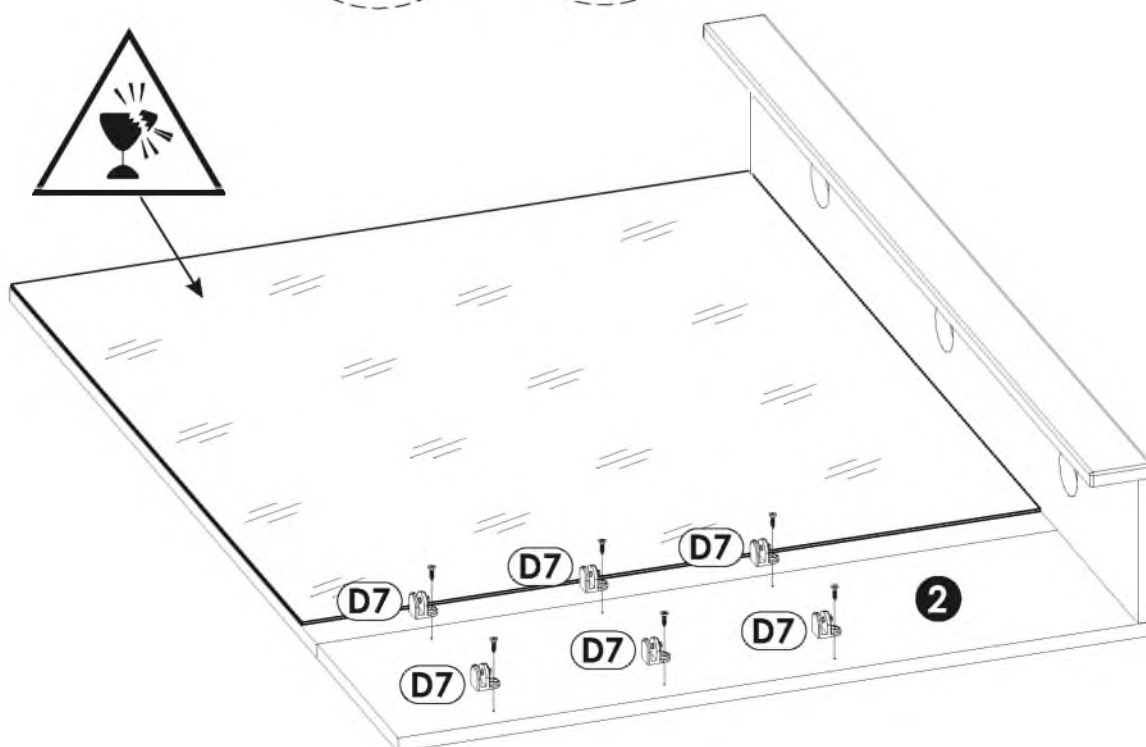
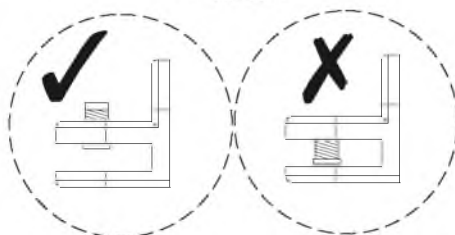
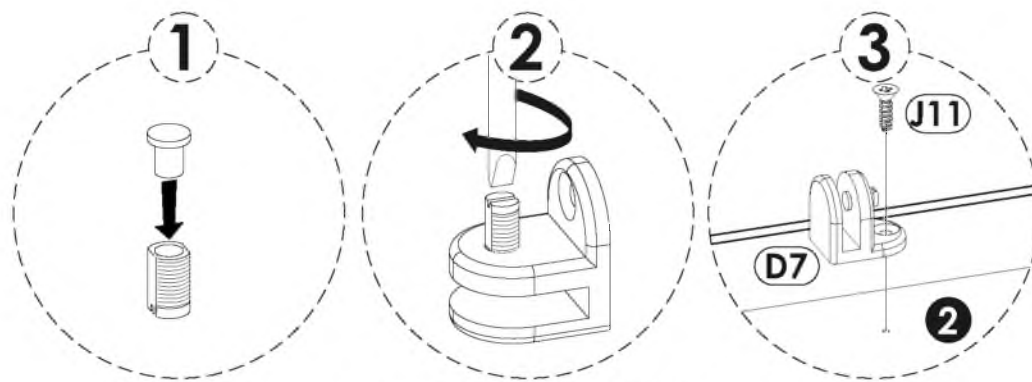
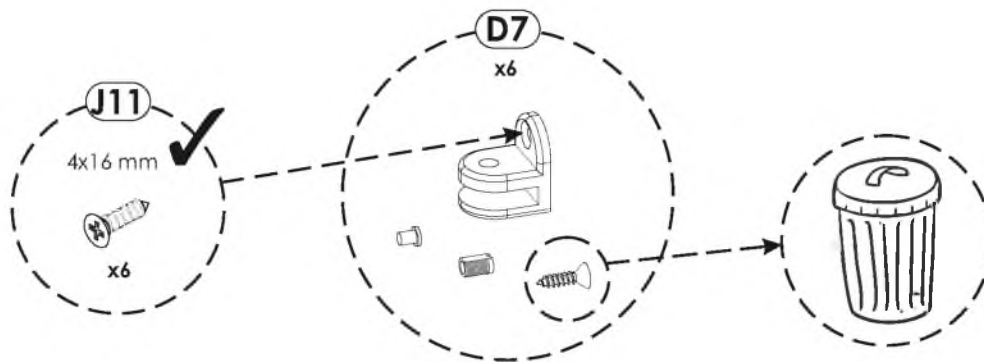
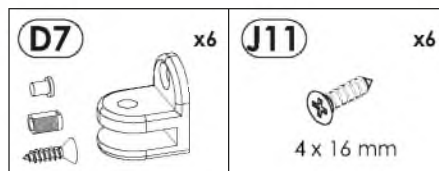
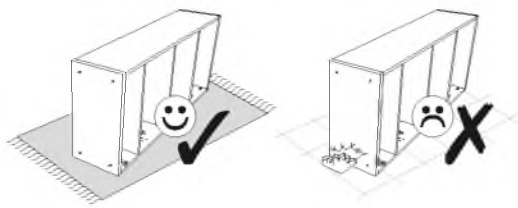

9 ▶

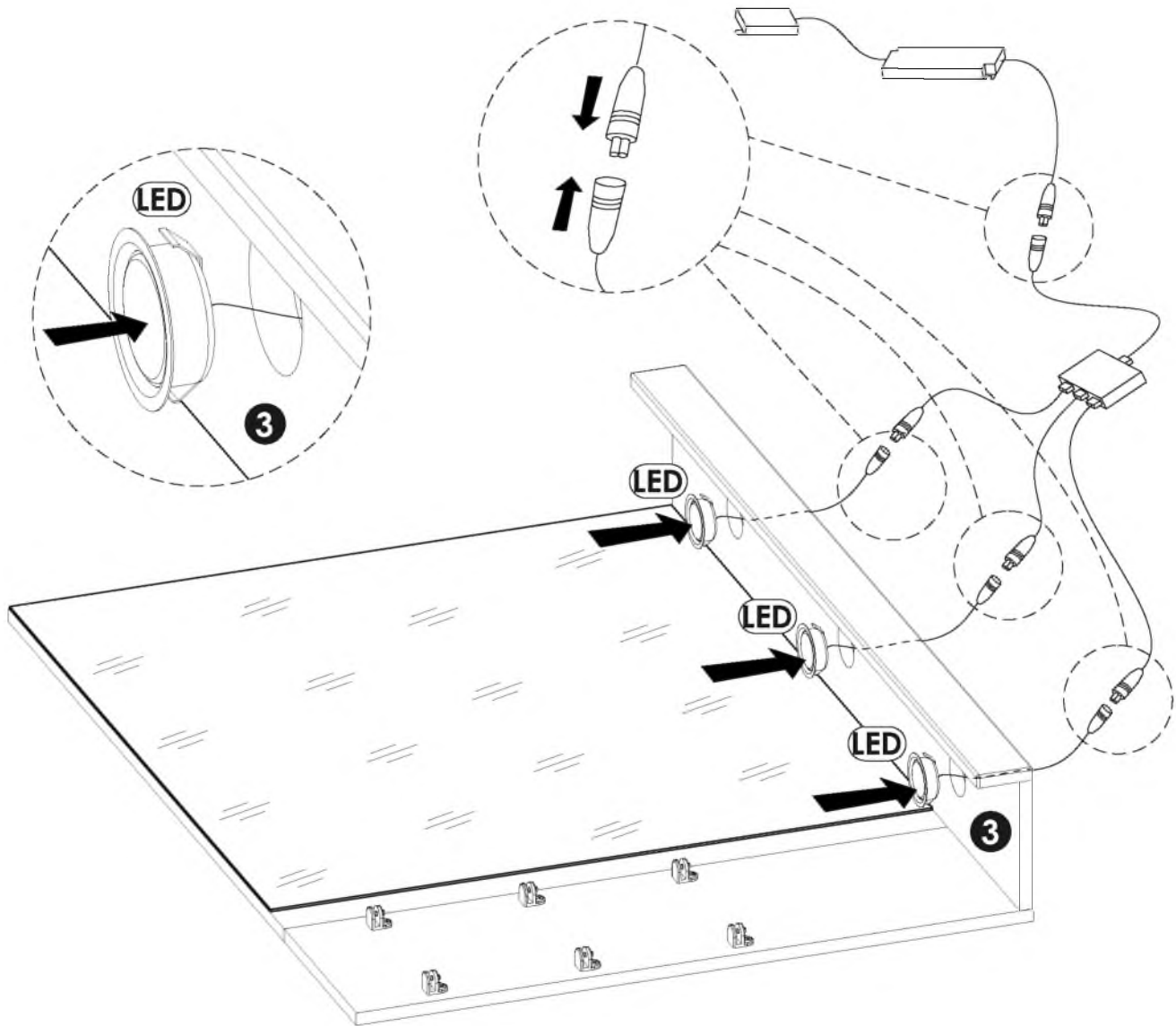
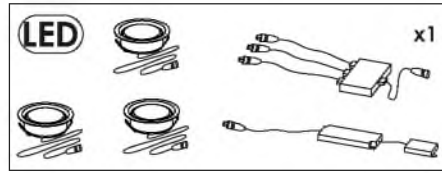
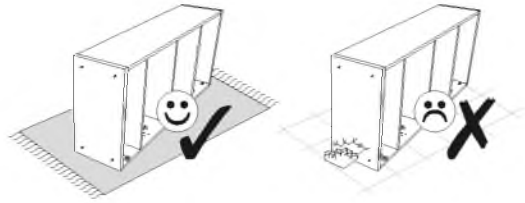

10 ▶

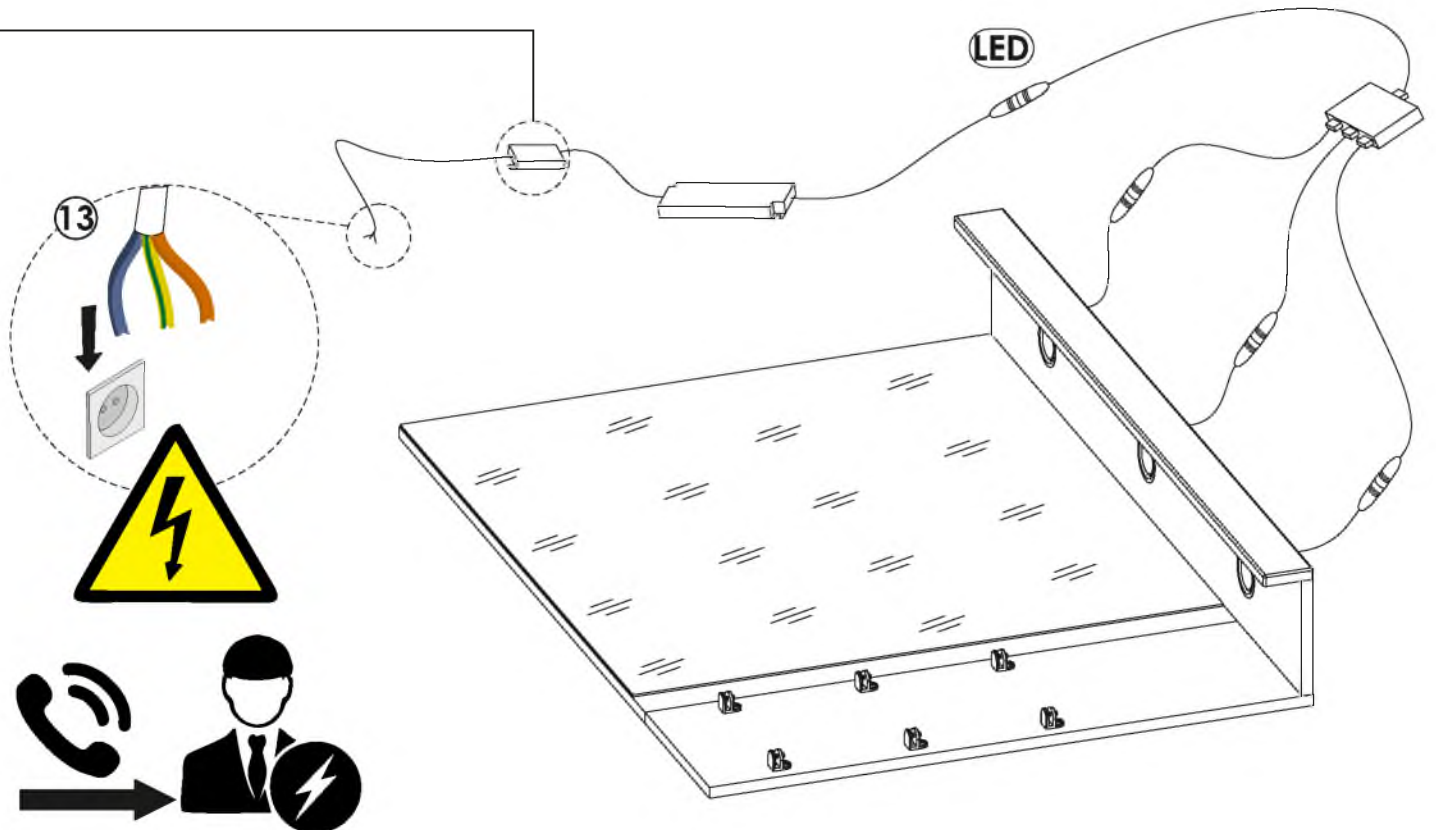
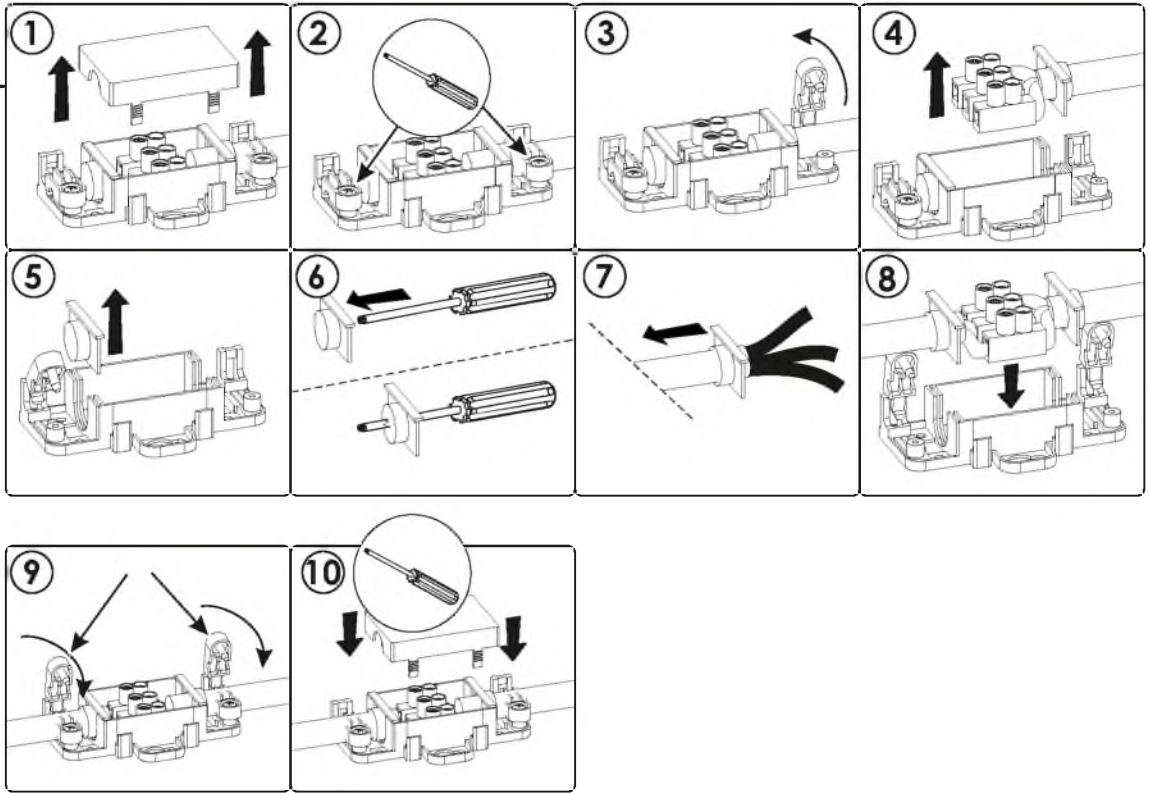
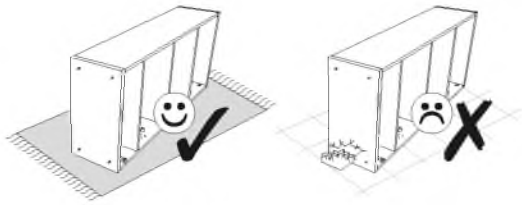

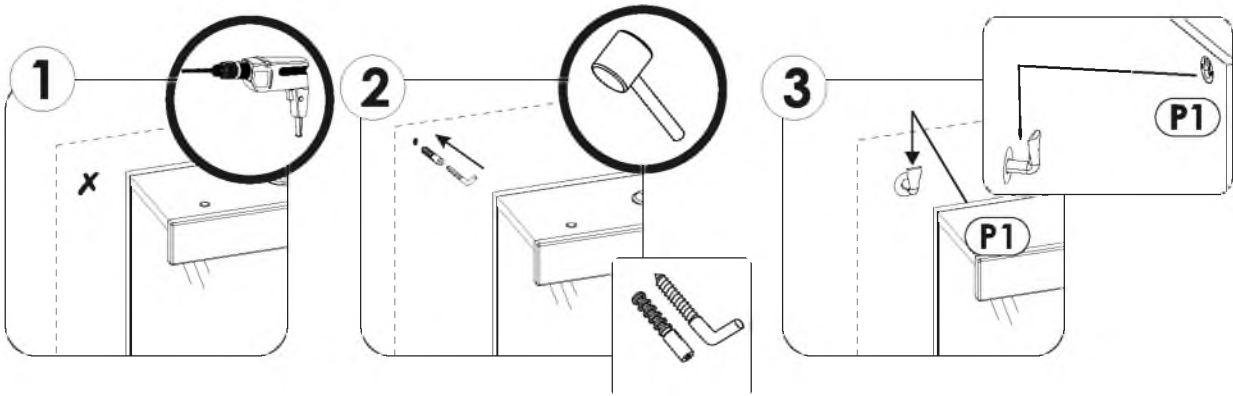
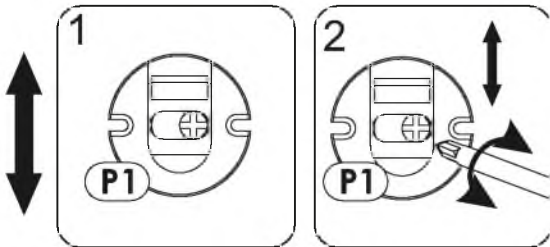
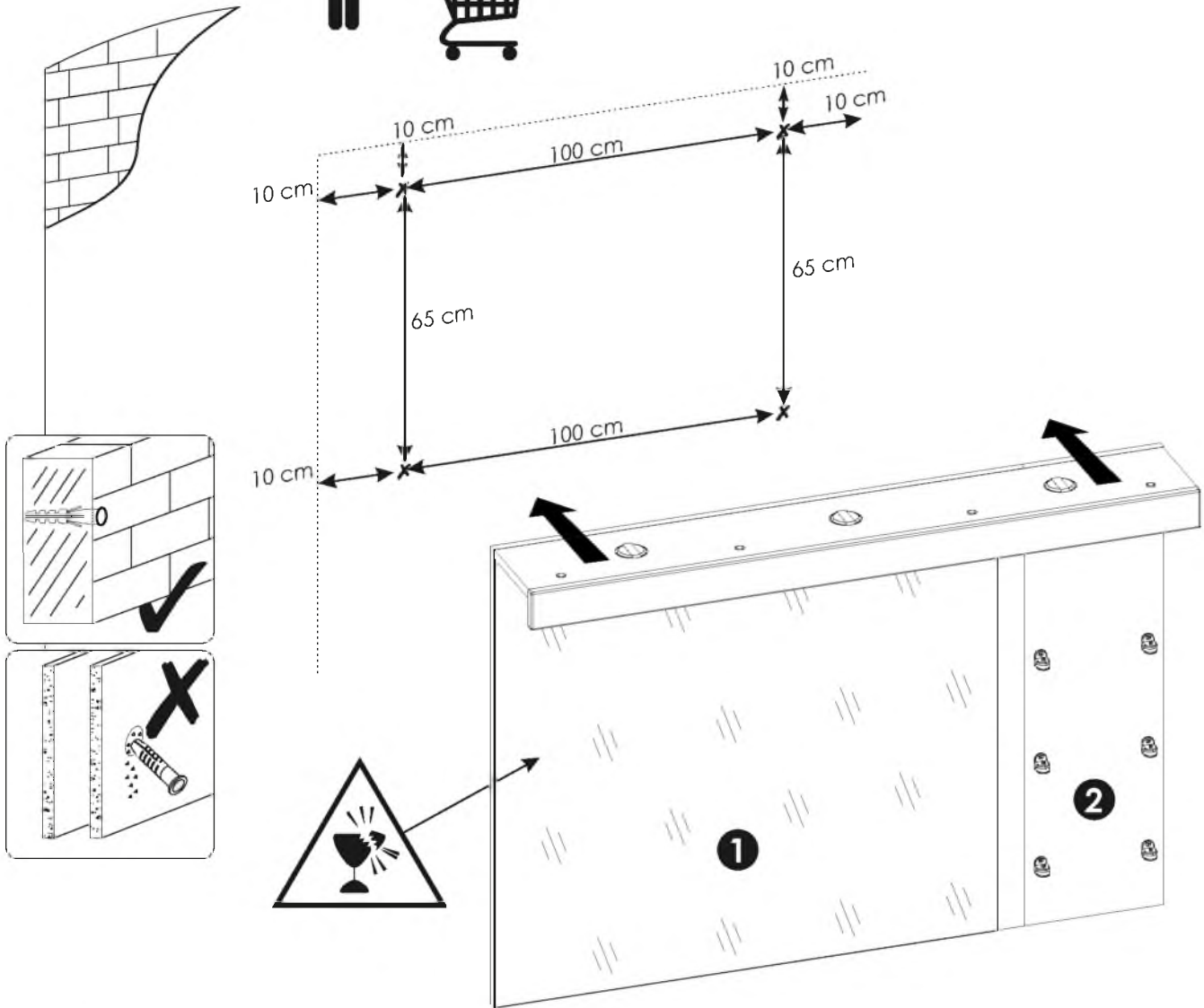

12▶

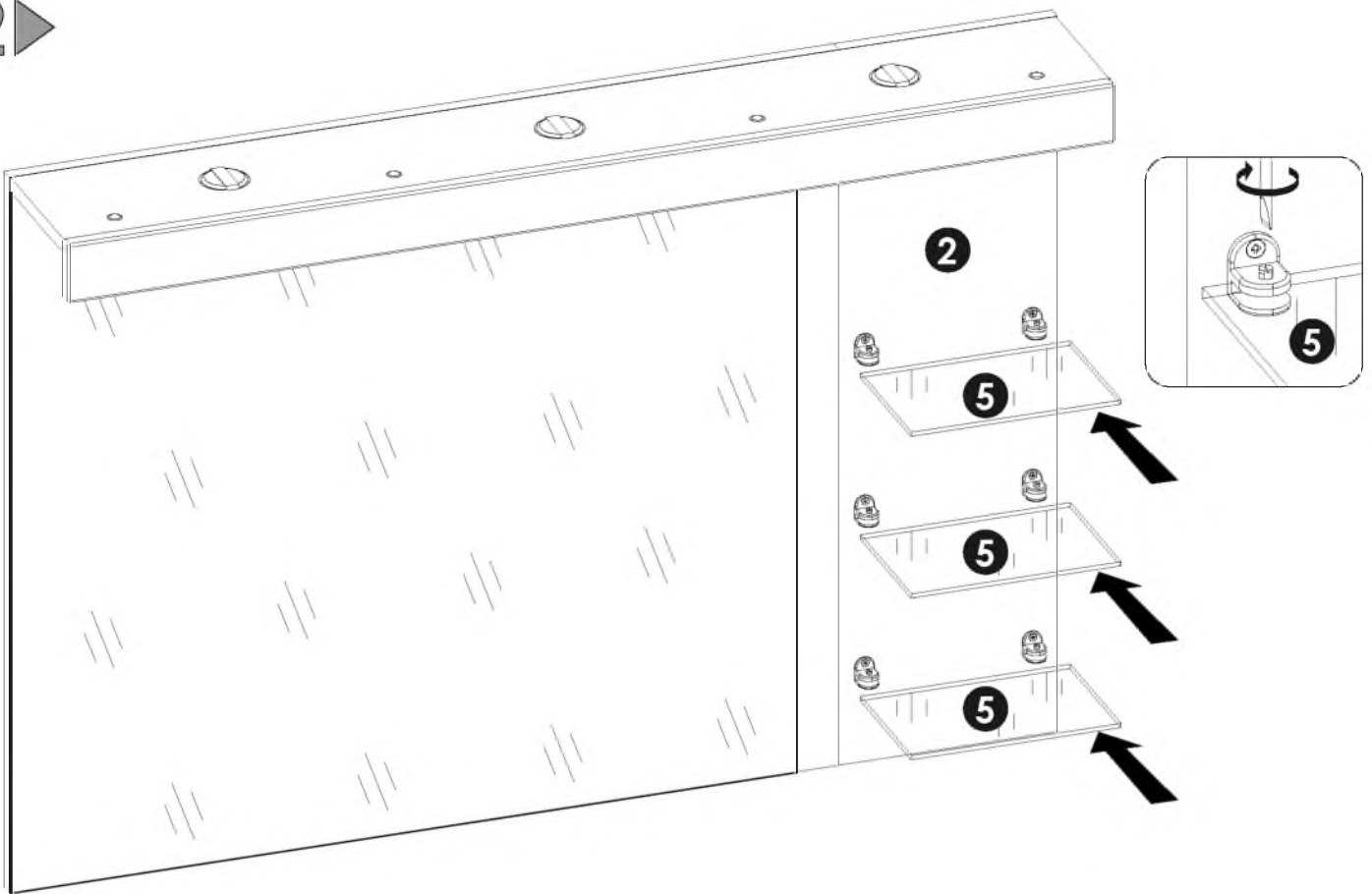

13▶

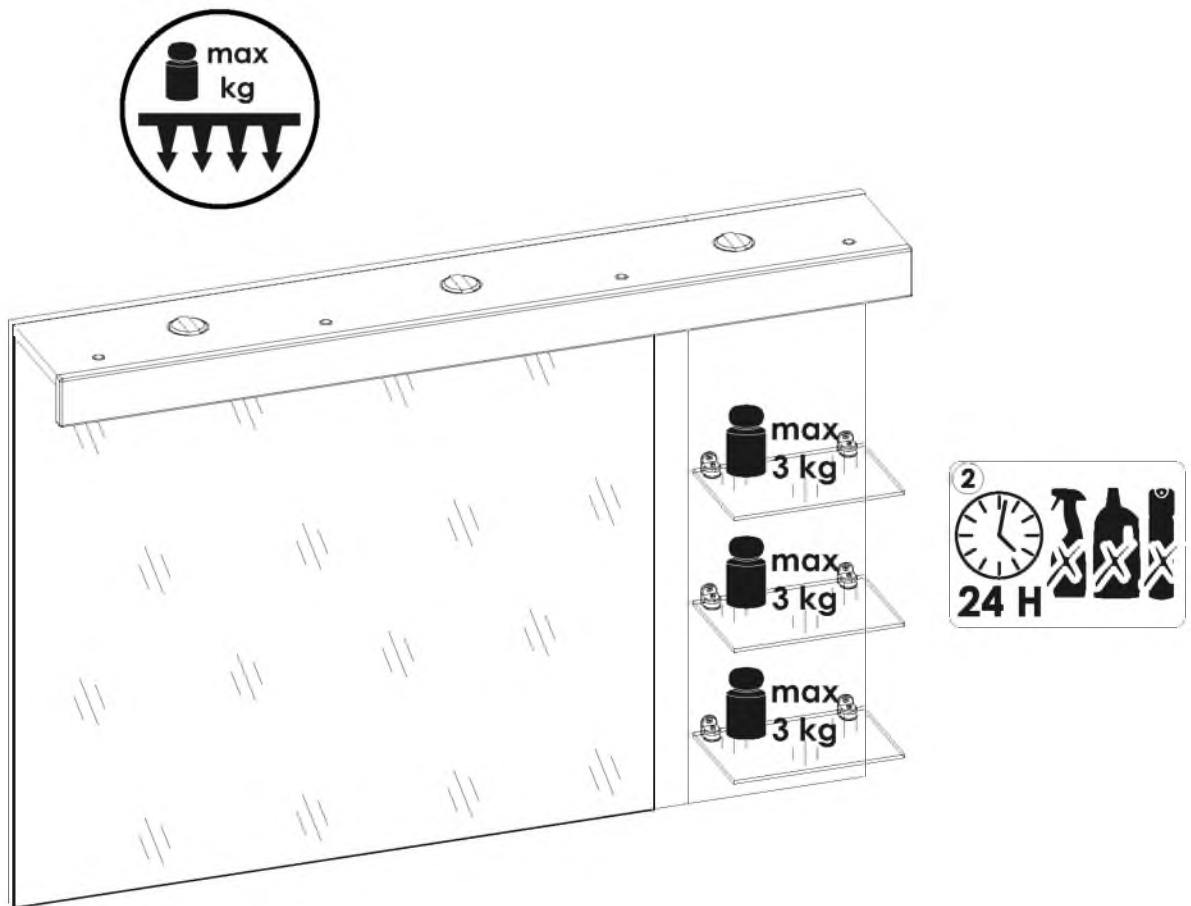

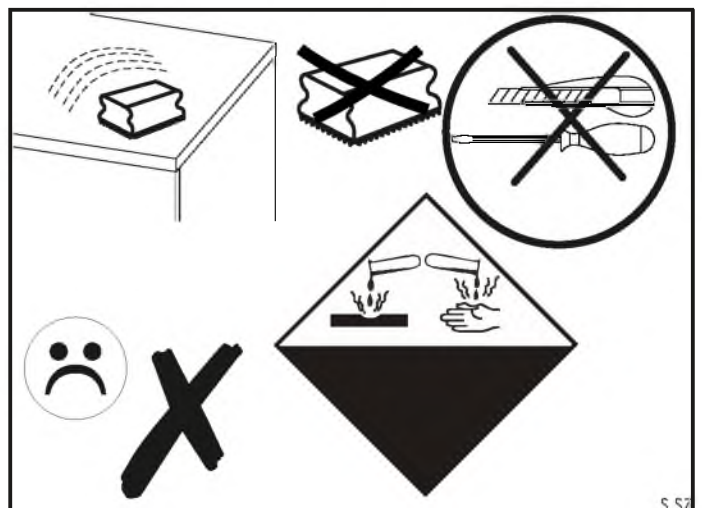
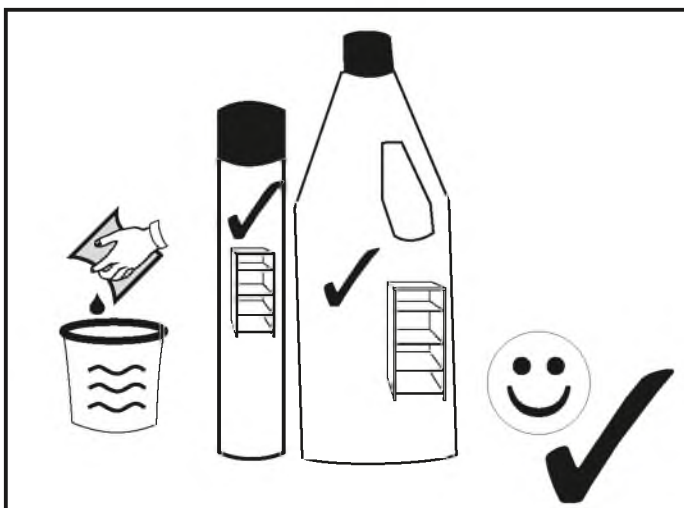
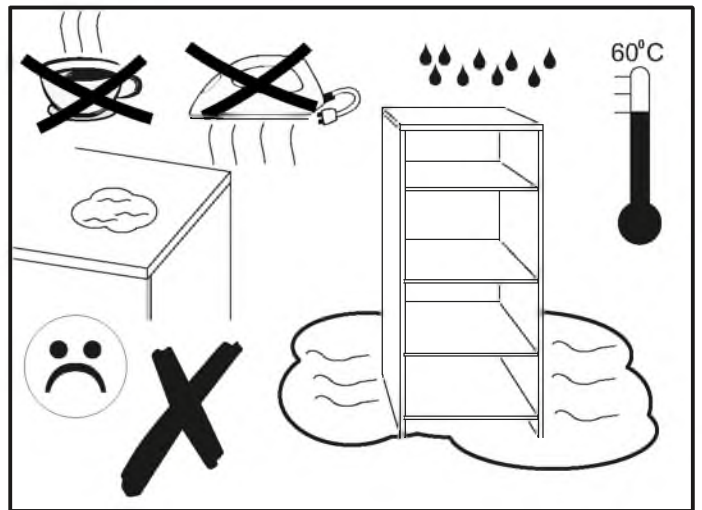
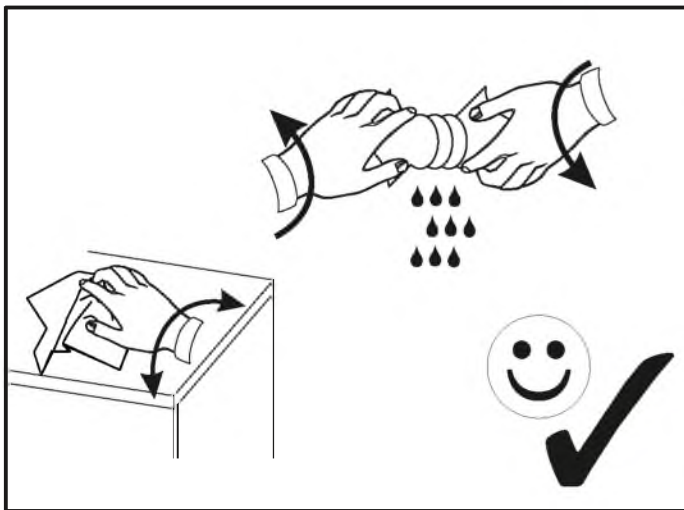
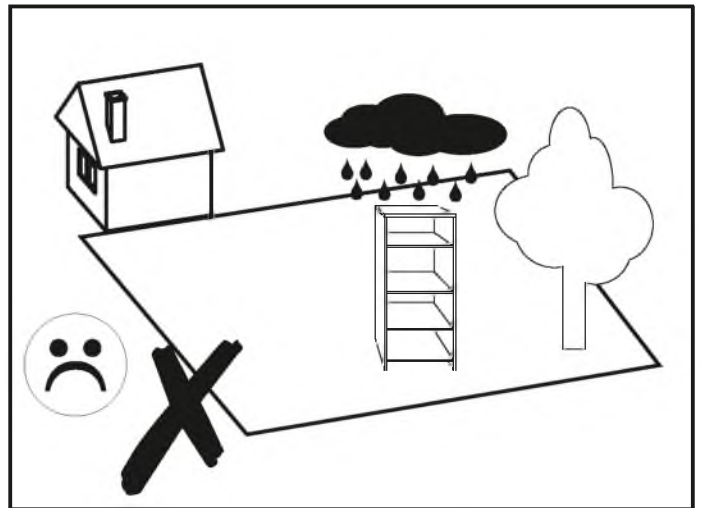
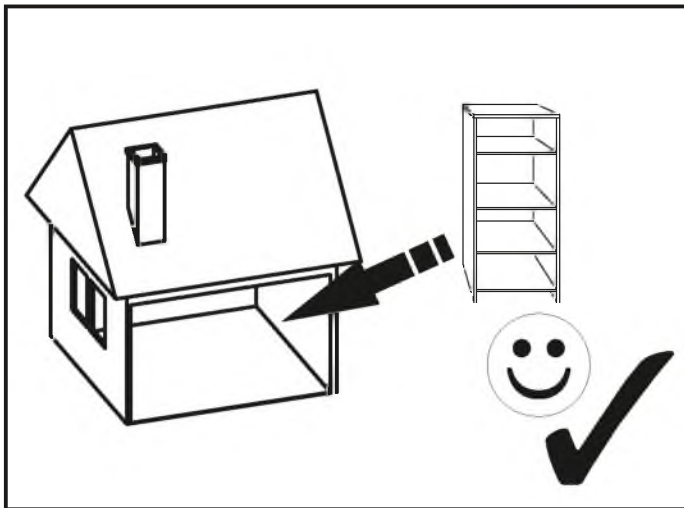

BWiX9067



80 min

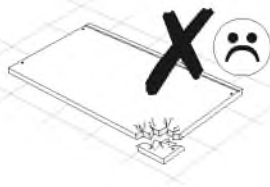
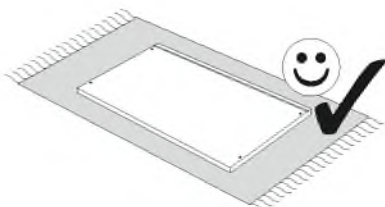
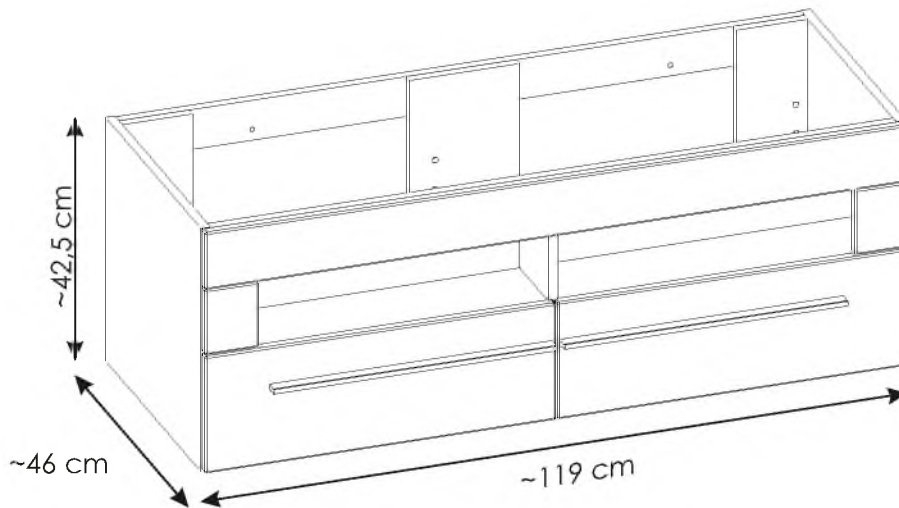
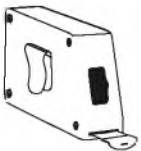
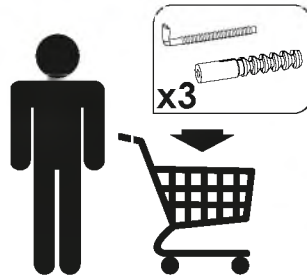

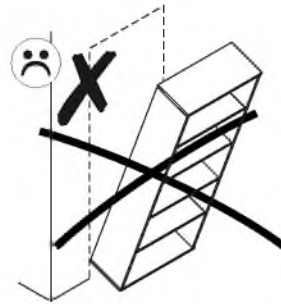
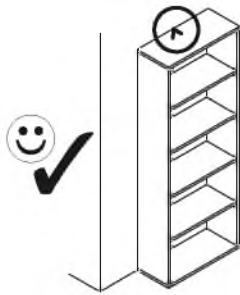

PL.

UWAGA! Mebel należy trwale zamocować do ściany, aby uniknąć ryzyka związanego z przewróceniem się mebla. W paczce nie ma śrub mocujących, ponieważ rodzaj mocowania należy odpowiednio dobrać do rodzaju ściany. Dobierz właściwe do Twojego rodzaju ściany.

D.

ACHTUNG! Um alle mit dem Umkippen des Möbels verbundenen Risiken auszuschließen, muss das Möbel fest an der Wand verankert werden. Beschläge für die Wandbefestigung sind nicht beige packt, da diese von der jeweiligen Wandbeschaffenheit abhängig sind. Bitte solche Befestigungsschläge wählen, die für die heimischen Wände geeignet sind.

FR.

ATTENTION! Ce meuble doit être fixé en permanence au mur pour éviter les risques de chute. Les vis de fixation ne sont pas livrées car le type de fixation doit être choisi en fonction du type de mur. Sélectionnez les fixations adaptées au mur.

I.

ATTENZIONE! Il mobile deve essere permanentemente fissato alla parete per evitare i rischi derivanti da un ribaltamento del mobile. La confezione non include le viti di fissaggio, in quanto il tipo di fissaggio deve essere scelto in base al tipo di parete. Utilizzare viti appropriate in base al materiale della parete.

HR.

NAPOMENA! Namještaj mora biti trajno pričvršćen za zid, kako bi se izbjegao rizik od njegovog prevrtanja. U paketu nema vijaka za pričvršćivanje, jer se vrsta montaže mora prilagoditi vrsti zida. Odaberite pravu vrstu prema Vašoj vrsti zida.

EN.

WARNING! To prevent this furniture from tripping over, fix it to the wall permanently. Fixing devices are not included since different wall materials require different types of fixing devices. Please make sure you chose the correct ones for your type of wall.

SK.

POZOR! Nábytok musí byť trvalo pripevnený k stene tak, aby sa zamedzilo riziku prevrátenia. Balík neobsahuje upevňovacie skrutky, pretože typ upevnenia je treba vybrať podľa typu steny. Vyberte typ vhodný pre Vašu stenu.

CZ.

POZOR! Nábytek je nutné pevně připevniť ke zdi, abychom se vyhnuli riziku spojenému s jeho převrhnutím. Součástí balení nejsou připevňovací šrouby, protože způsoby připevnění je nutné zvolit podle druhu stěny. Vyberte správný pro Váš typ stěny.

RU.

ПРИМЕЧАНИЕ! Эту мебель необходимо всегда прикреплять к стене, чтобы избежать рисков, связанных с переворотом мебели. В пакете нет крепежных винтов, потому что тип крепления должен быть выбран в соответствии с типом стены. Выберите, пожалуйста, правильные винты к вашей стене.

RO.

ATENȚIE! Mobila trebuie ancorată permanent în perete pentru a evita riscul de răsturnare a mobilei. În pachet nu sunt incluse șuruburile de fixare, deoarece tipul de ancoraj trebuie ales în funcție de tipul de perete. Alegeți șuruburile potrivite pentru tipul Dvs. de perete.

TR.

DİKKAT! Devrimle riskini önlemek için mobilya duvara sabitlenmelidir. Sabitleme civataları pakete dahil değil, çünkü sabitleme tertibatının tipi, duvara tipine uygun olarak seçilmelidir. Onu duvarınızın tipine göre seçiniz.

AR.

ملاحظة!

يجب تثبيت الأثاث بإحكام إلى الحائط أو الجدار لتجنب خطر إنقلابه. لا تحتوي العلبة على مسامير التثبيت، إذ إنه ينبغي استعمال المسامير المخصصة لنوعية الحائط أو الجدار. اختر المسامير التي تناسب جدارك.

E.

¡ATENCIÓN! El mueble debe ser fijado permanentemente a la pared para evitar el riesgo relacionado con el vuelco del mueble. En el paquete no hay tornillos de fijación, ya que se debe elegir el tipo de fijación adecuado para el tipo de pared. Elija el apropiado para su tipo de pared.

CN.

注意！本家具需要固定在墙上以免倒塌。箱子里没有安装螺钉。因为安装方式需要根据墙的类型调整。请按照您的墙类型选择合适的安装方式。

SLO.

POZOR! Pohištvo trajno pritrđite na steno, da preprečite tveganje, da se prevrne. V paketu ni pritrđilnih vijakov, saj je treba način pritrđitve ustrezno izbrati glede na vrsto stene. Izberite način, ki je ustrezen za vašo steno.

HU.

FIGYELEM! Rögzítse a bútorokat a falhoz, hogy elkerülje a bútor felborulásának kockázatát. A készletben nem találhatóék rögzítőcsavarok, mivel a rögzítés típusa a fal típusától függ. Válassza ki a fal típusának megfelelő kötőelemeket.

NL.

OPMERKING! De meubelen moeten permanent aan de muur worden bevestigd om te voorkomen dat de meubelen kantelen. Er zitten geen bevestigingsschroeven in het pakket, omdat het type bevestiging moet worden gekozen op basis van het type muur. Kies de juiste voor uw type muur.

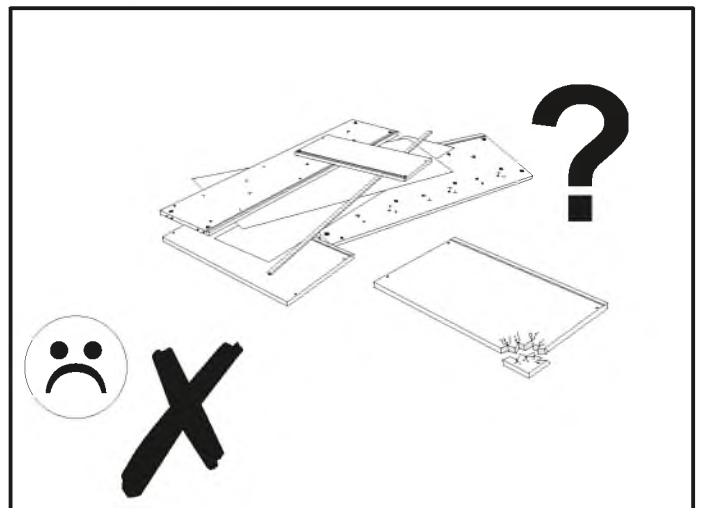
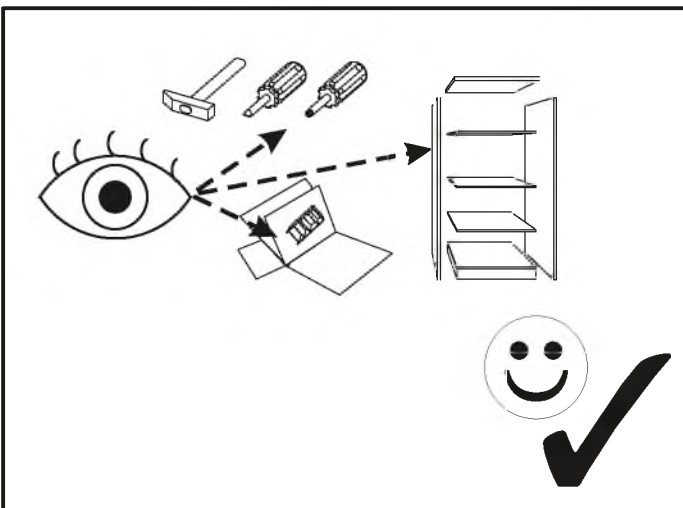
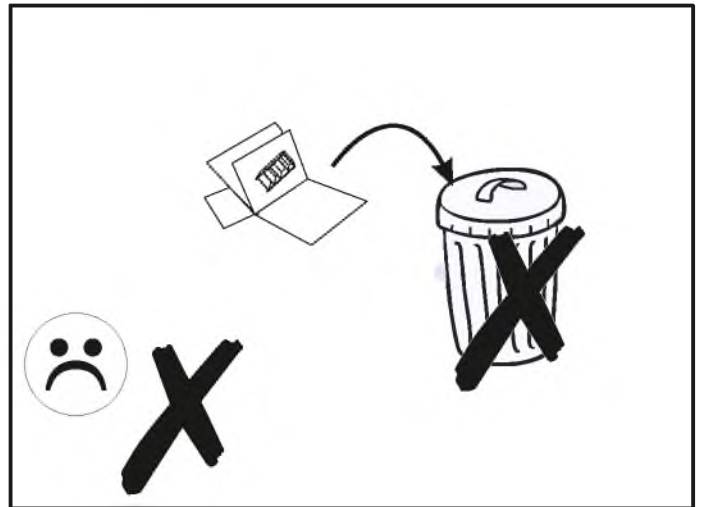
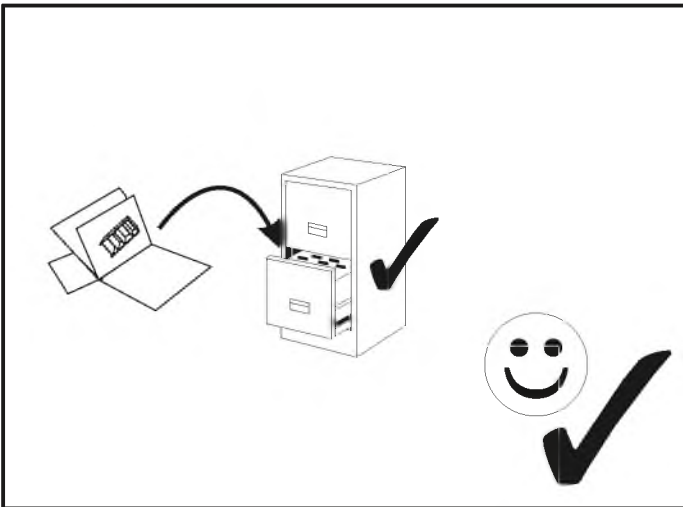
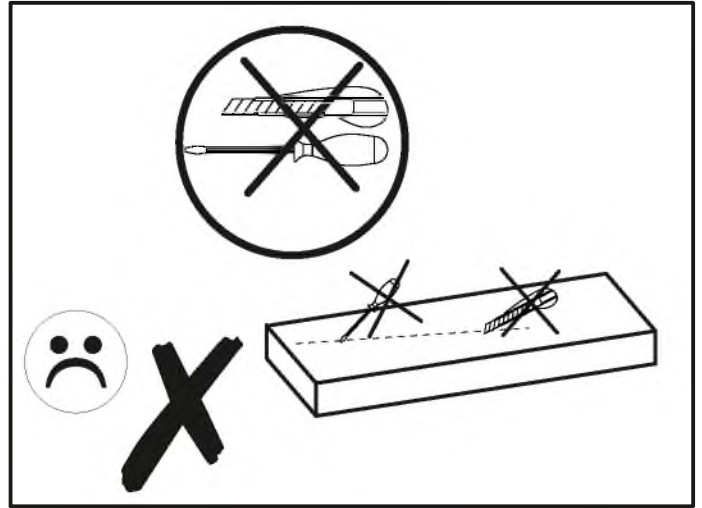
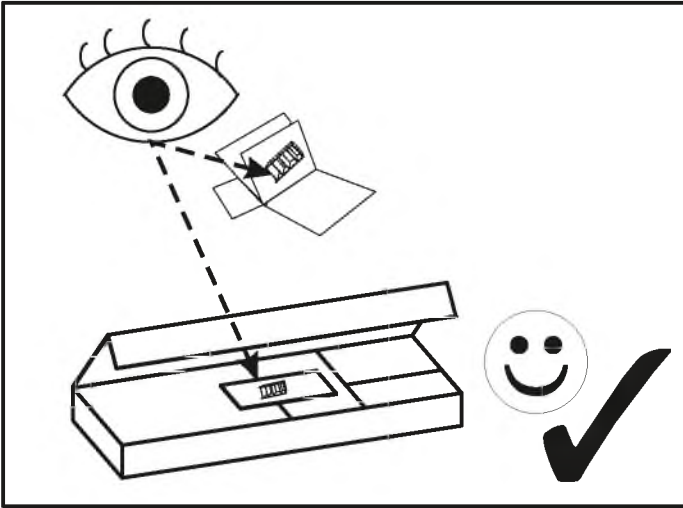



version A

Bx

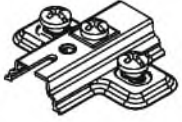

Bx

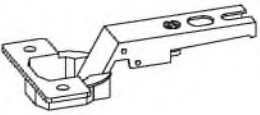

version B

Bx + Bx

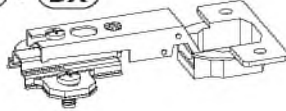



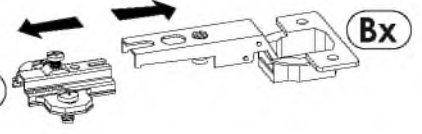



Bx

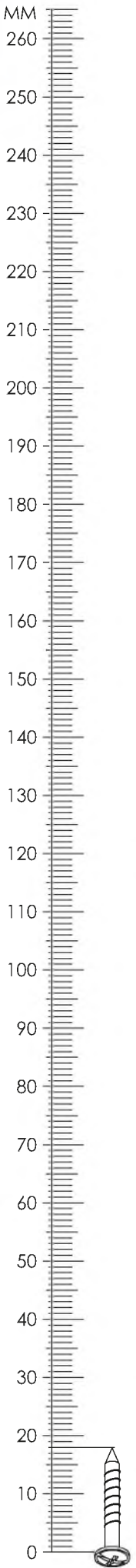

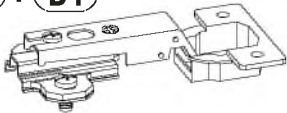
Bx

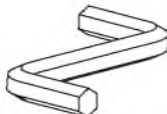
BWiX9067

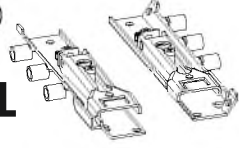
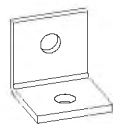
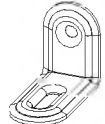

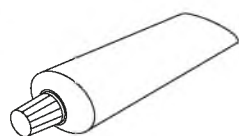
A0	8 x 24 mm	x6	A1	8 x 35 mm	x22	A2	8 x 45 mm	x8
B0 + B1		x4	C2	5 x 13 mm	x8	C5	6.3 x 13 mm	x6
E0	Ø16	x8	E1	15 x 12 mm	x20	F1	6 x 34 mm	x20
G0		x7	G1	7 x 50 mm	x10	H1	L - 478 mm	x2
I0	3 x 13 mm	x2	I4	4 x 27 mm	x4	I6	3.5 x 27 mm	x8
J2	4 x 25mm	x14	J16	5 x 70 mm	x2	M		x1
N0	3 X 13 mm	x6	N2	3,5 X 16mm	x10	P		x2
P0	Ø8	x2	P3	Ø10	x6	P8C		x1
Q2		x1	Q8		x2	R8		x4
S		x1	X	L - 546 mm	x2			

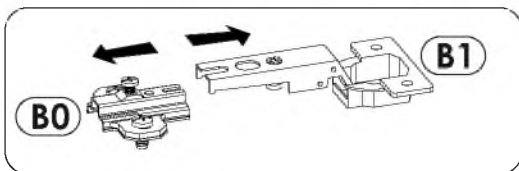

BWiX9067

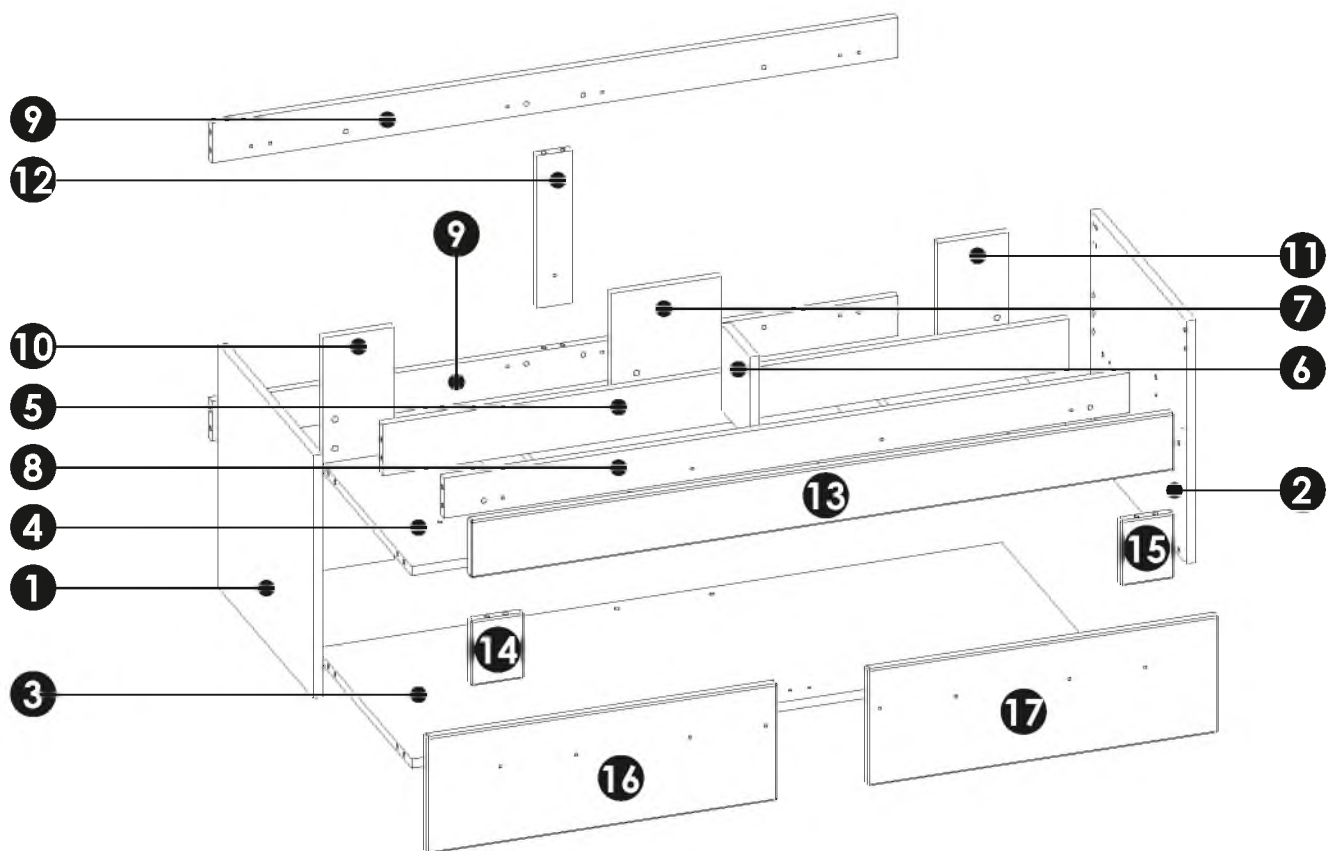
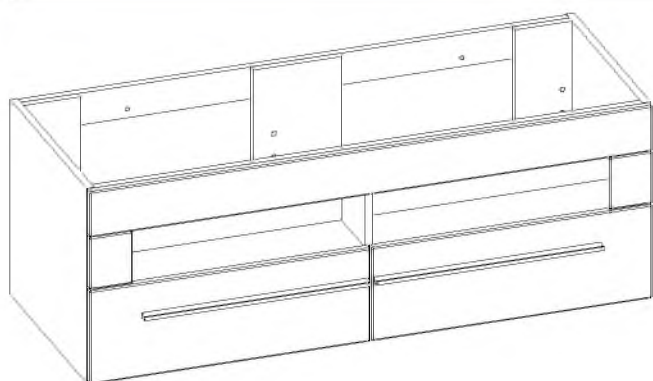

1	425	444	16	x1	1/1
2	425	444	16	x1	1/1
3	1158	444	16	x1	1/1
4	1158	411	16	x1	1/1
5	1158	90	16	x1	1/1
6	150	133	16	x1	1/1
7	407	186	16	x1	1/1
8	1158	70	16	x1	1/1
9	1158	70	16	x2	1/1

10	407	120	16	x1	1/1
11	407	120	16	x1	1/1
12	267	60	16	x1	1/1
13	1187	100	16	x1	1/1
14	114	90	16	x1	1/1
15	114	90	16	x1	1/1
16	592	204	16	x1	1/1
17	592	204	16	x1	1/1

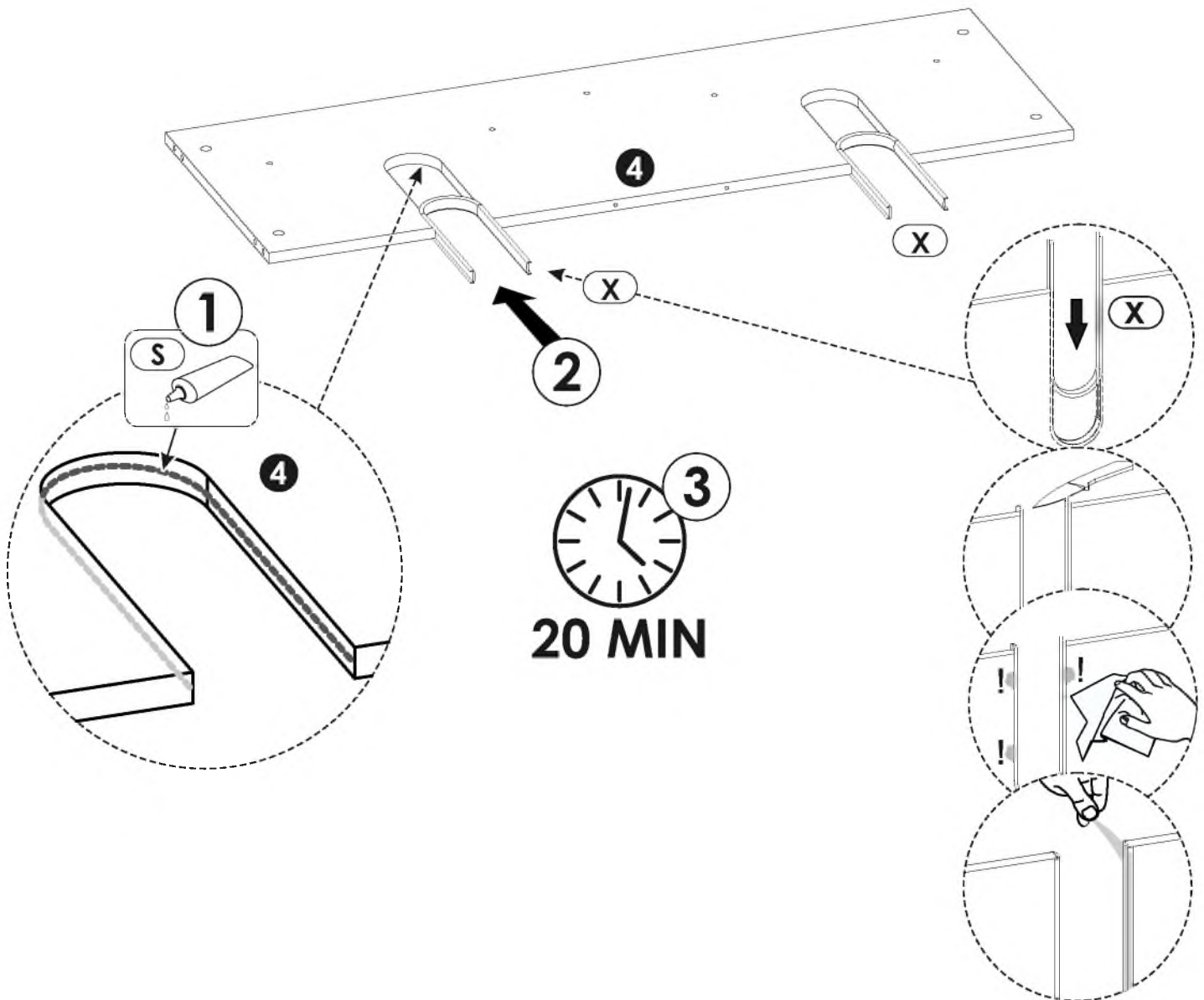
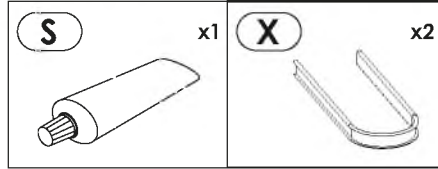
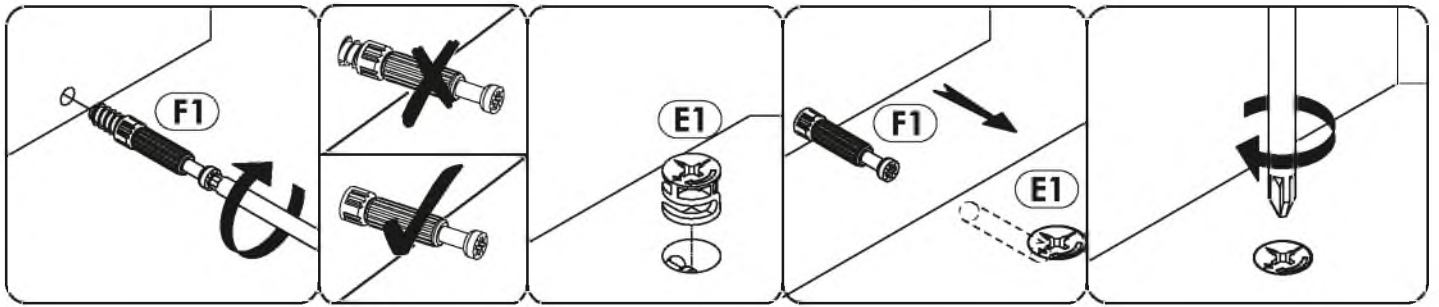

2 ▶

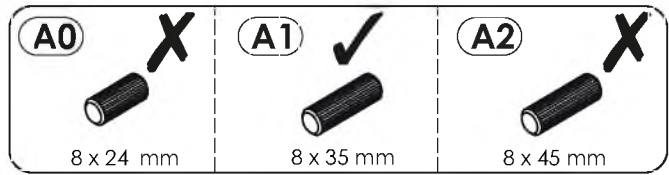
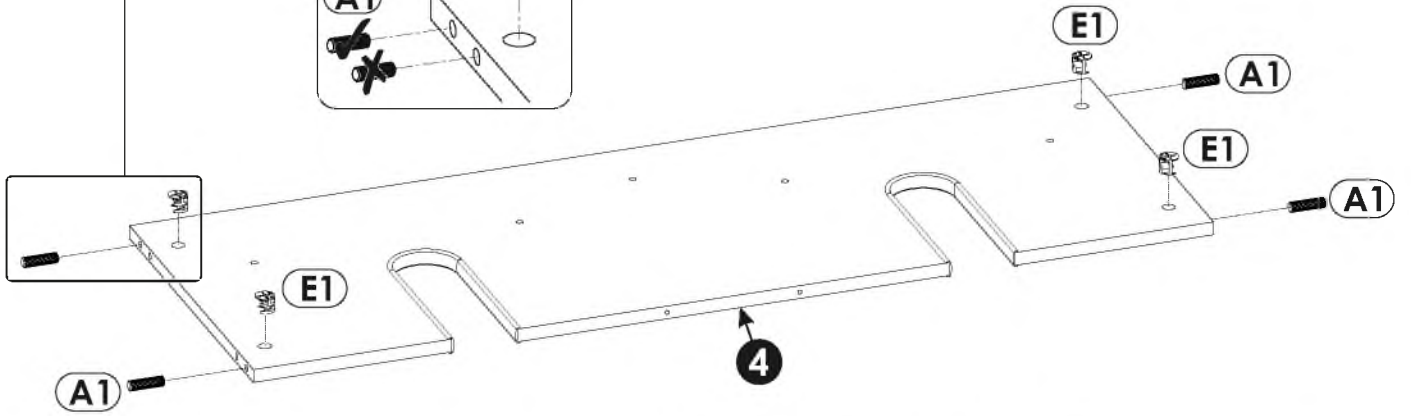
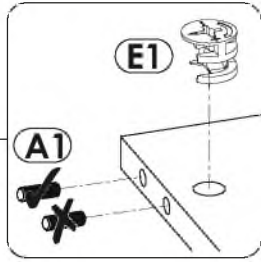
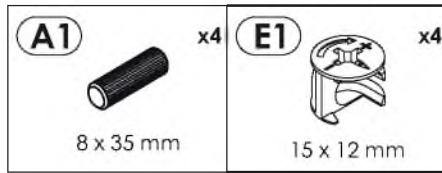

3 ▶

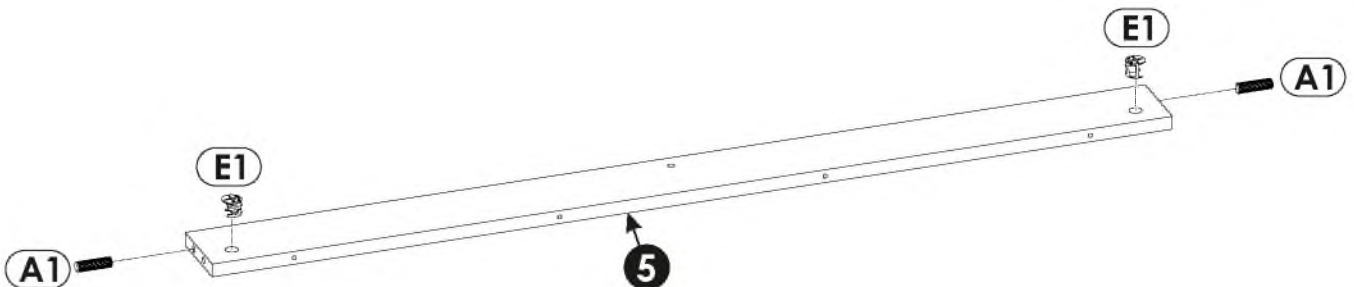
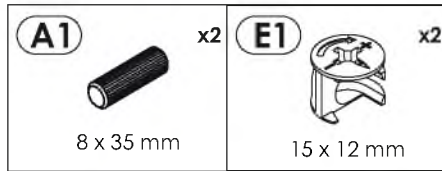
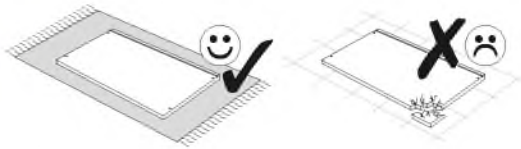

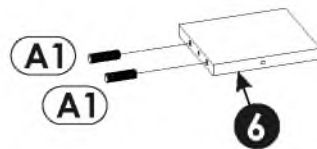
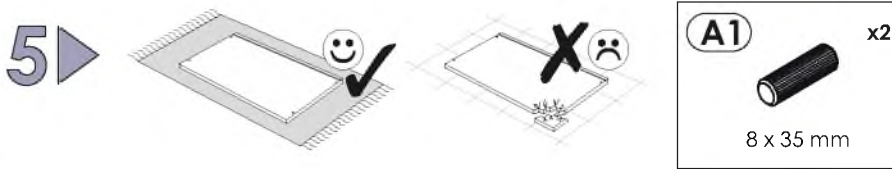
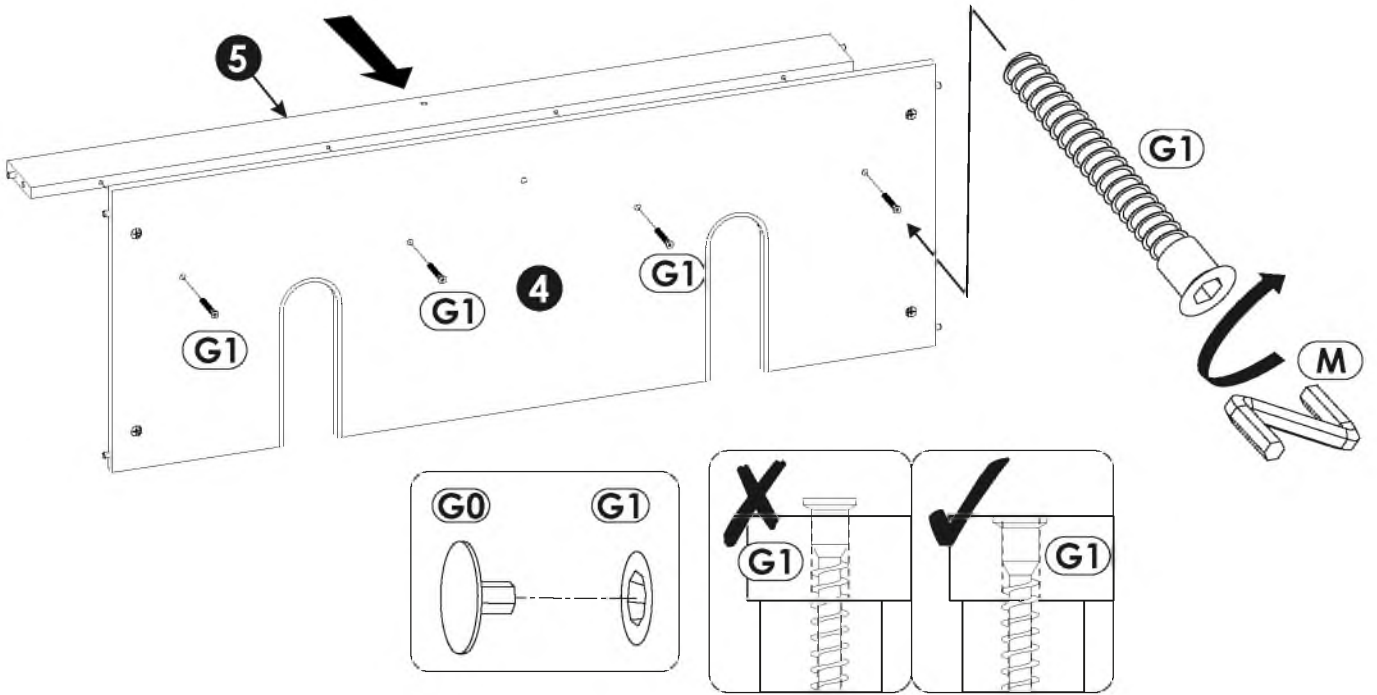
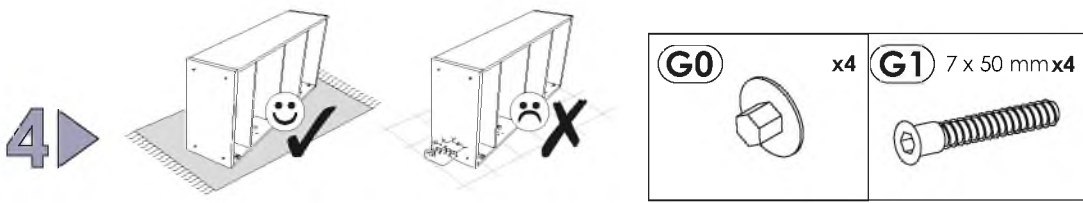

6 ▶

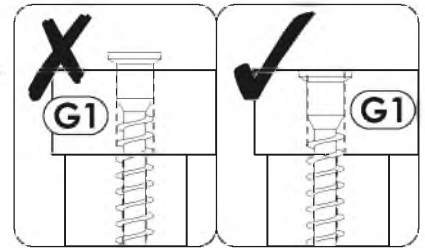
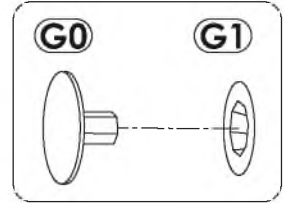
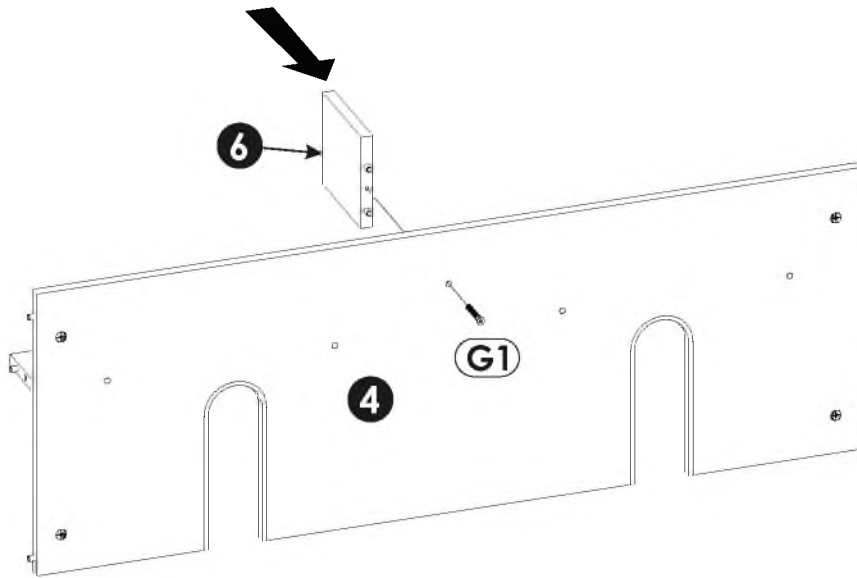
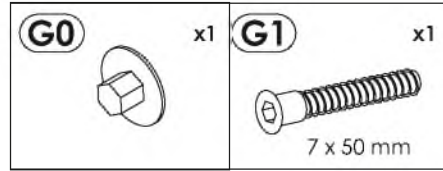
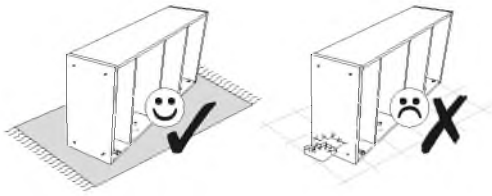

7 ▶

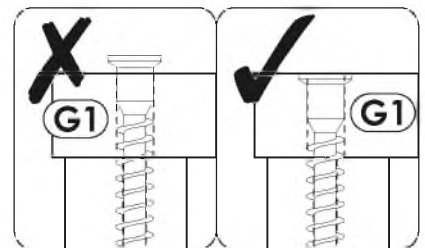
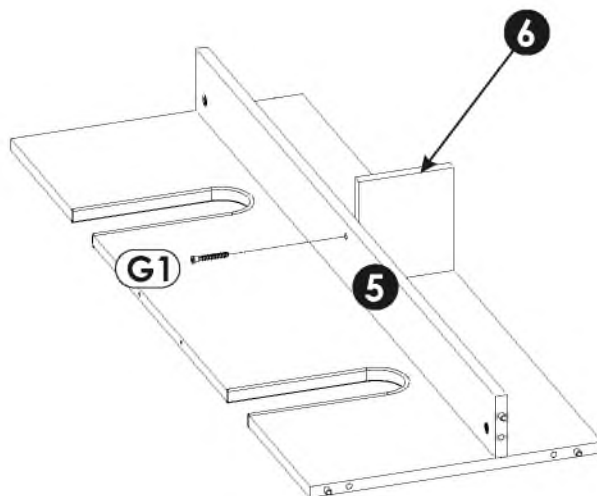
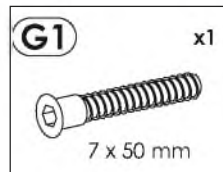
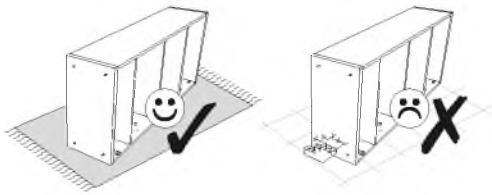

8 ▶

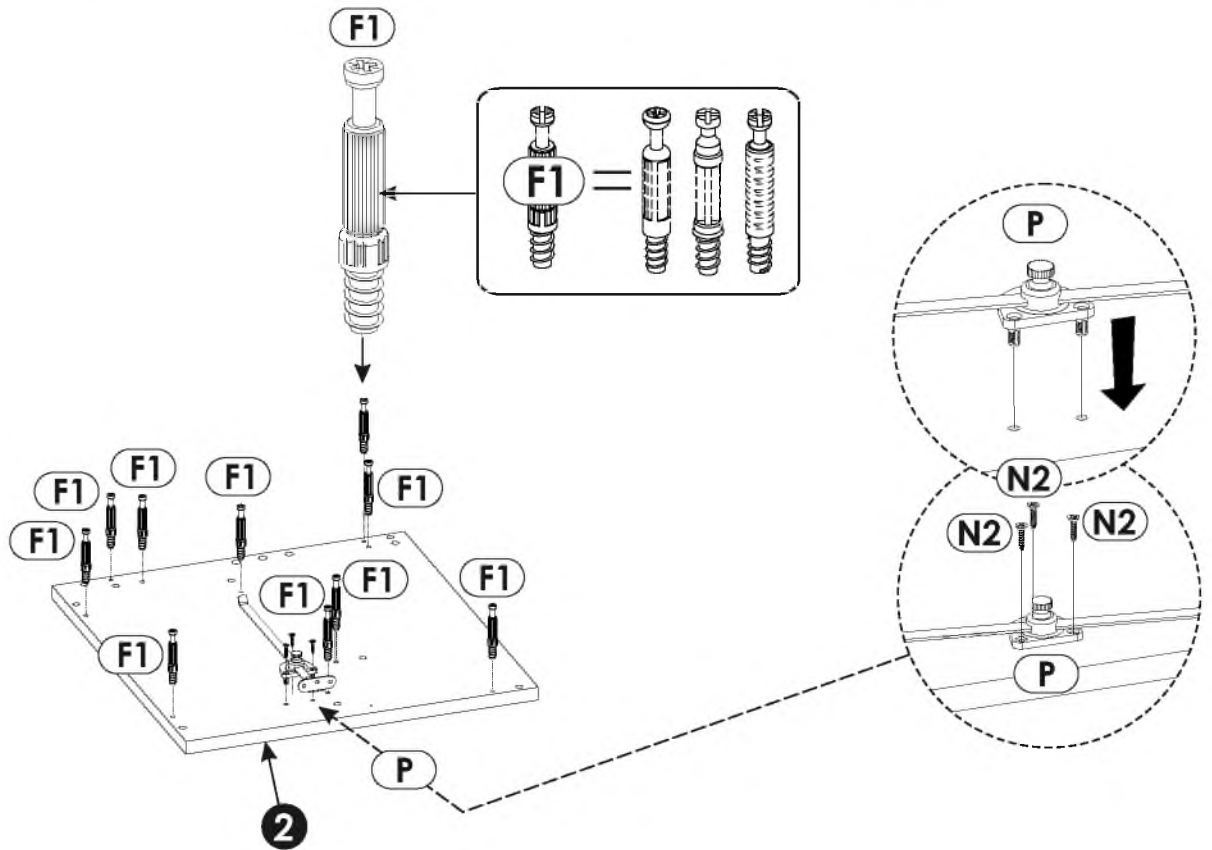
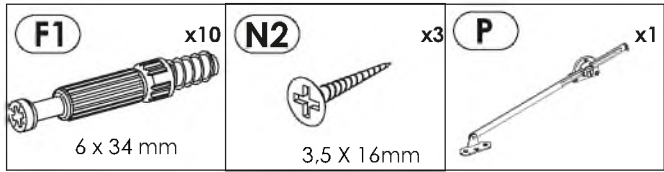
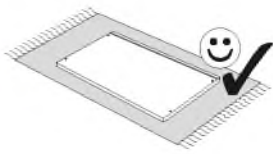

9 ▶

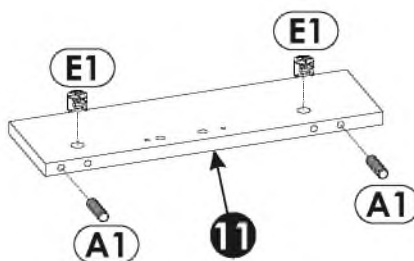
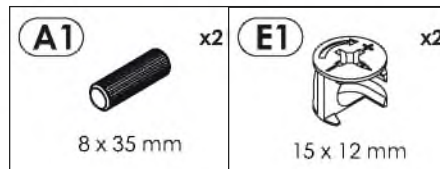
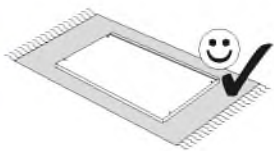

10 ▶

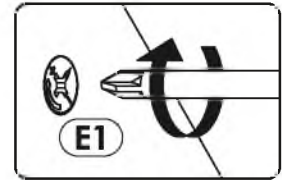
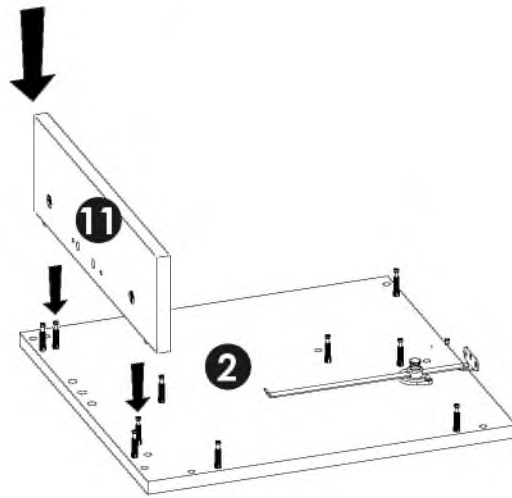
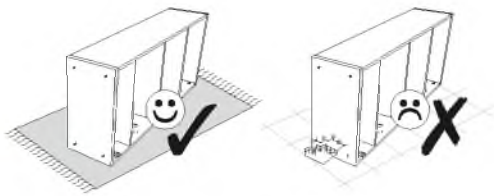

11 ▶

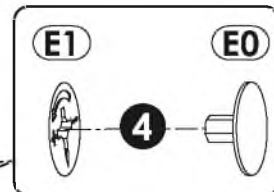
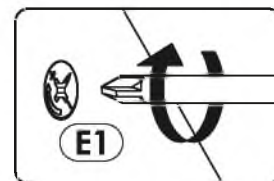
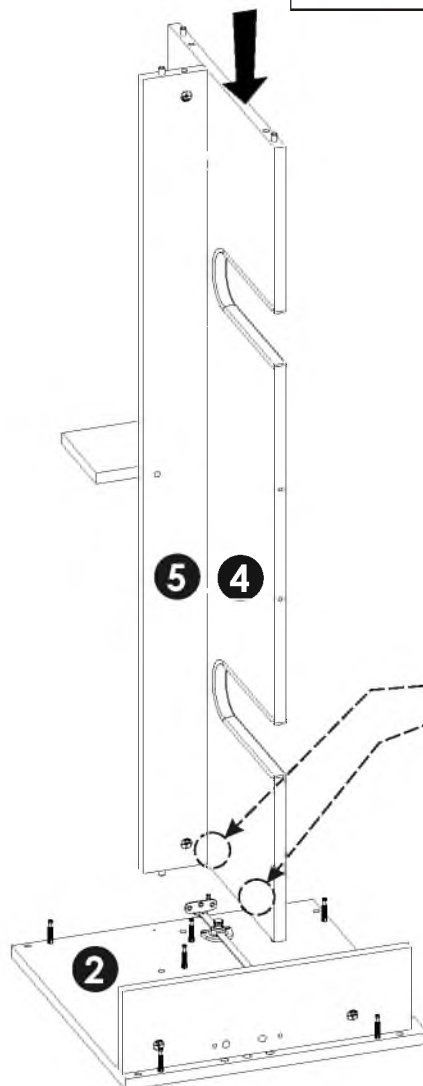
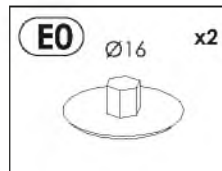
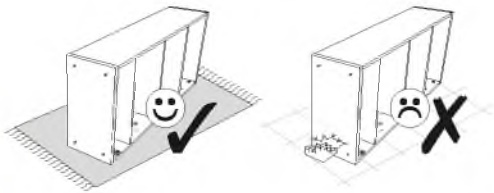

12 ▶

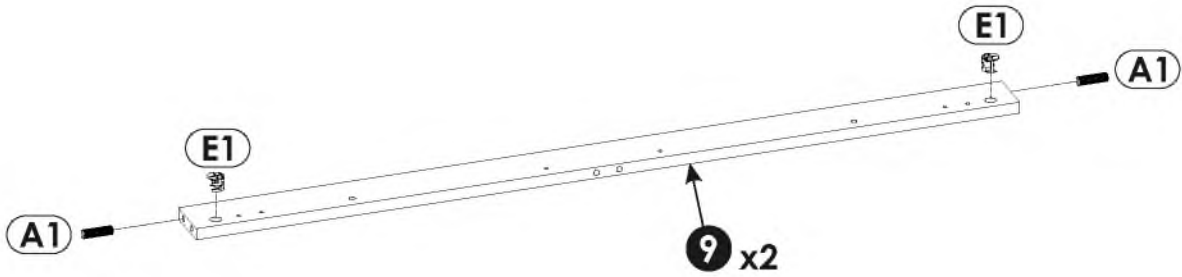
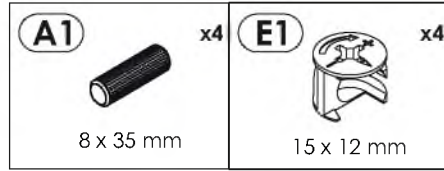

13 ▶

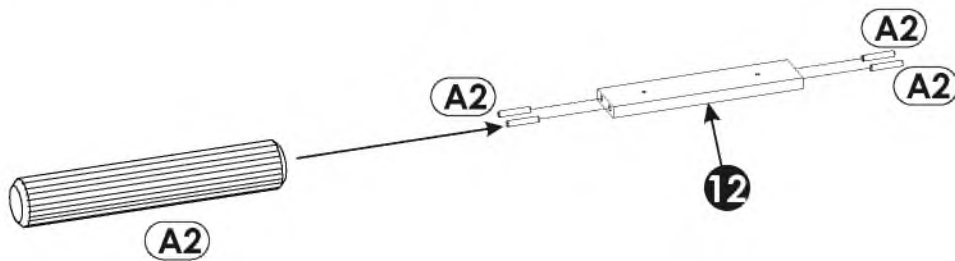
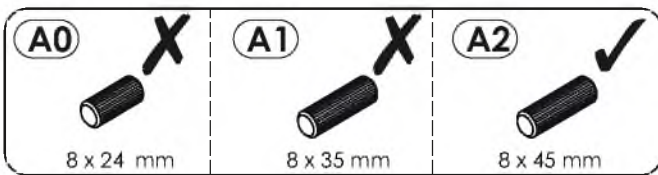

14▶

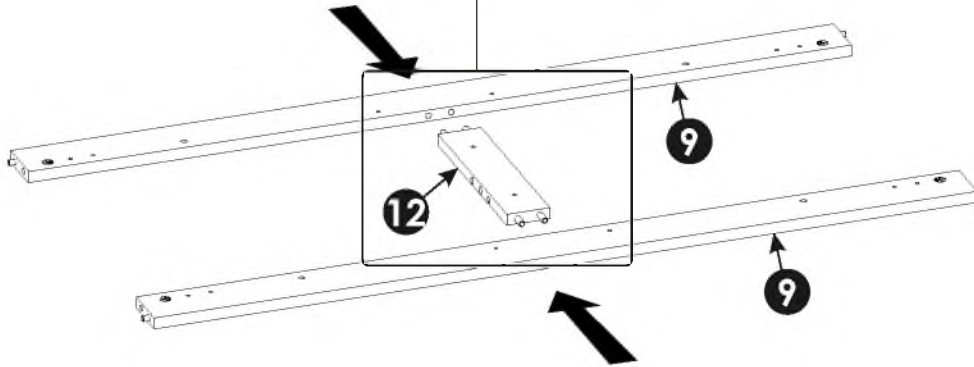
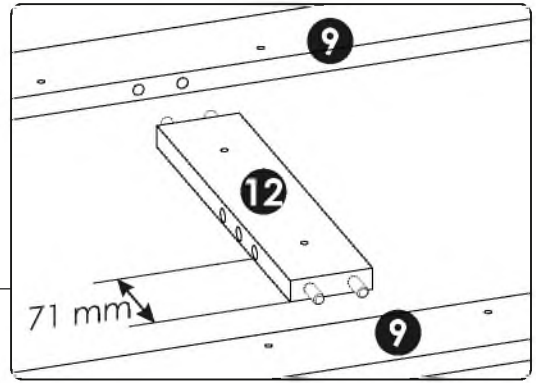
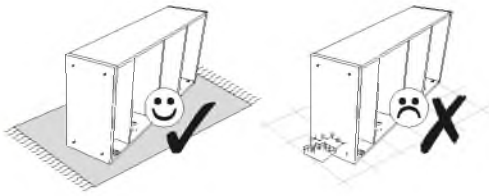

15▶

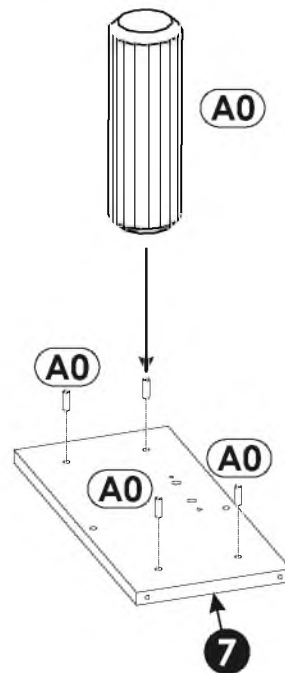
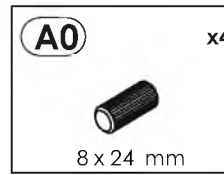

16 ▶

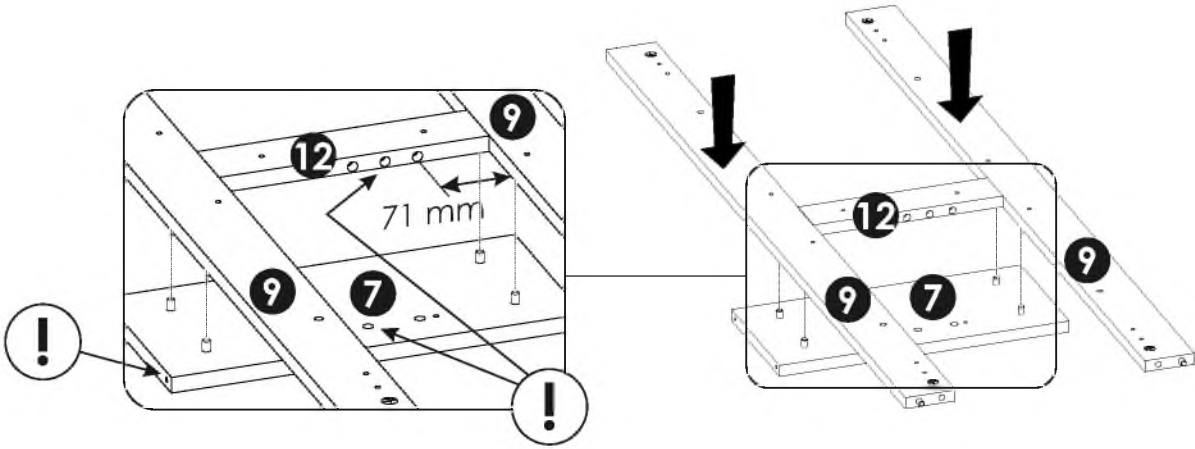
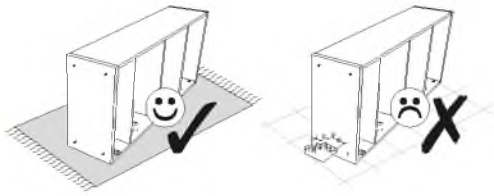

17 ▶

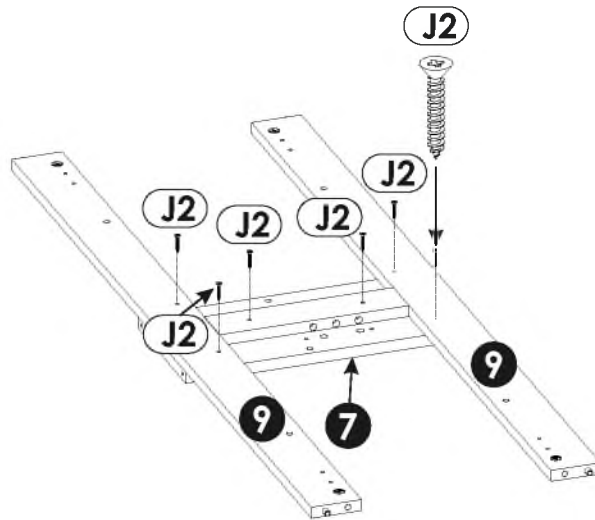
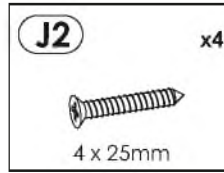
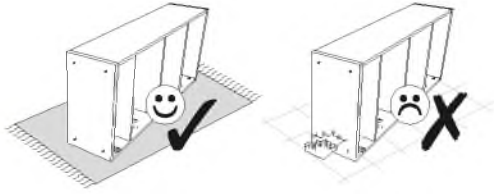

18 ▶

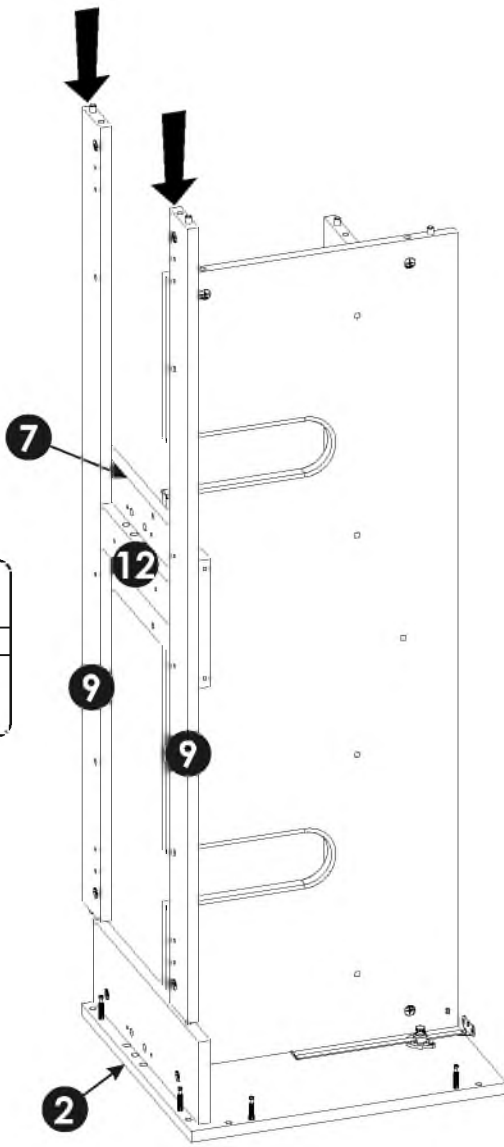
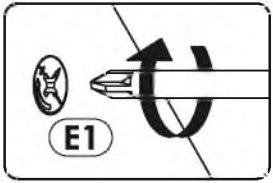
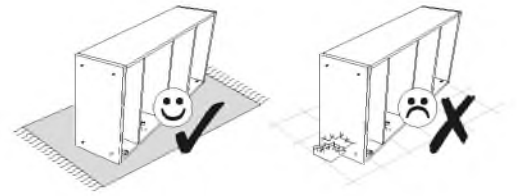

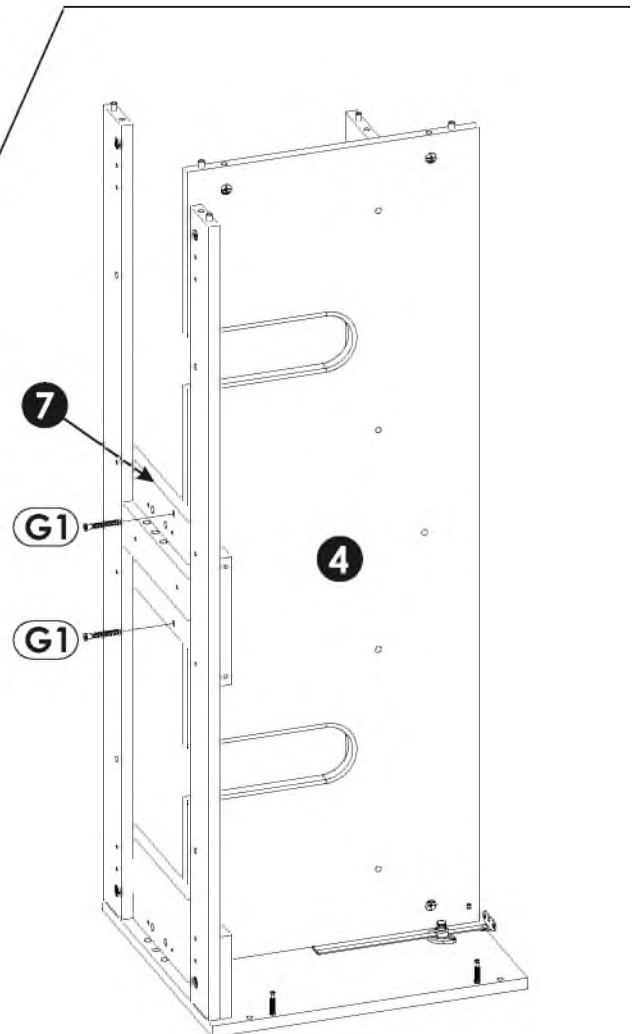
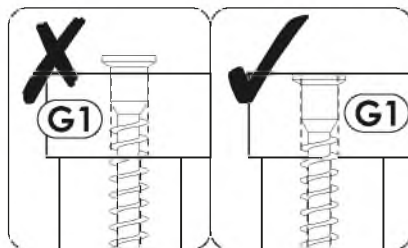
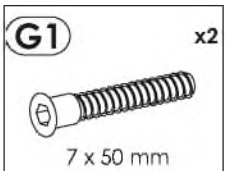
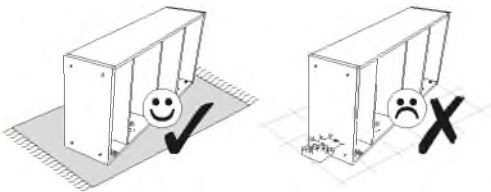

19 ▶



20 ▶



A1	x4	B0	x4	E1	x4
					
8 x 35 mm				15 x 12 mm	

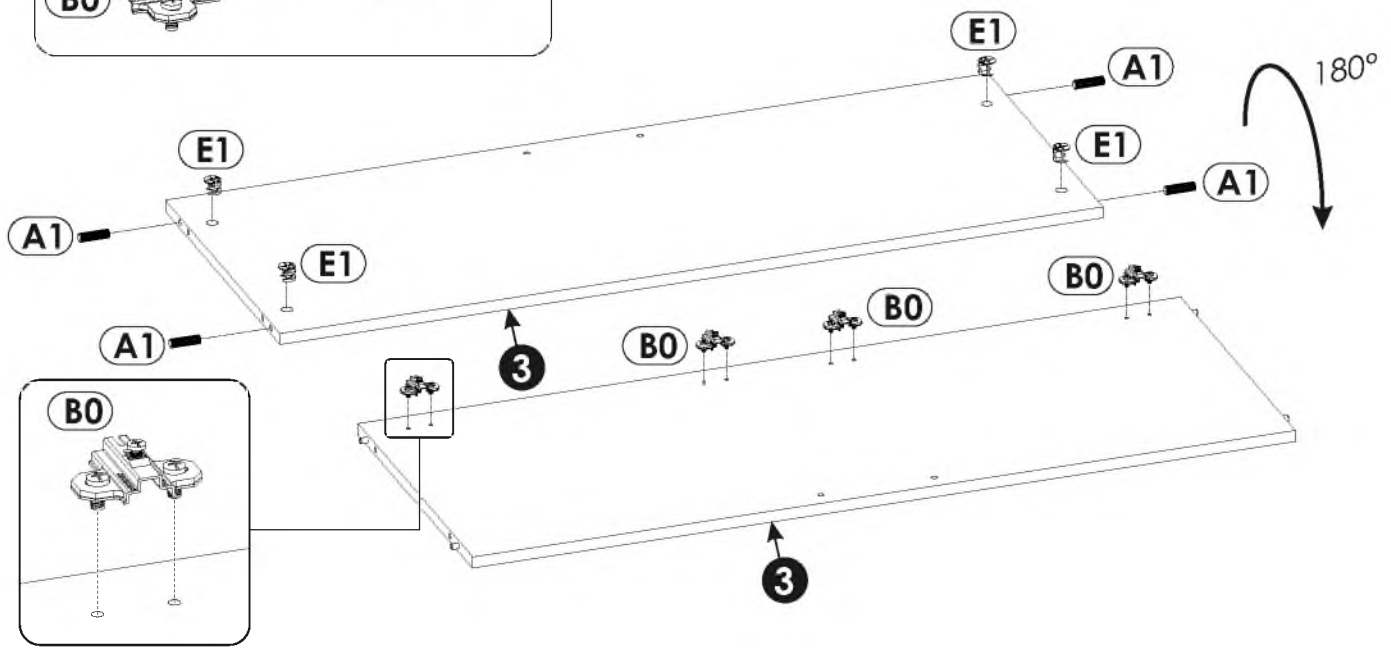
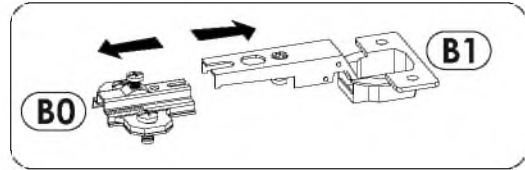

21 ▶

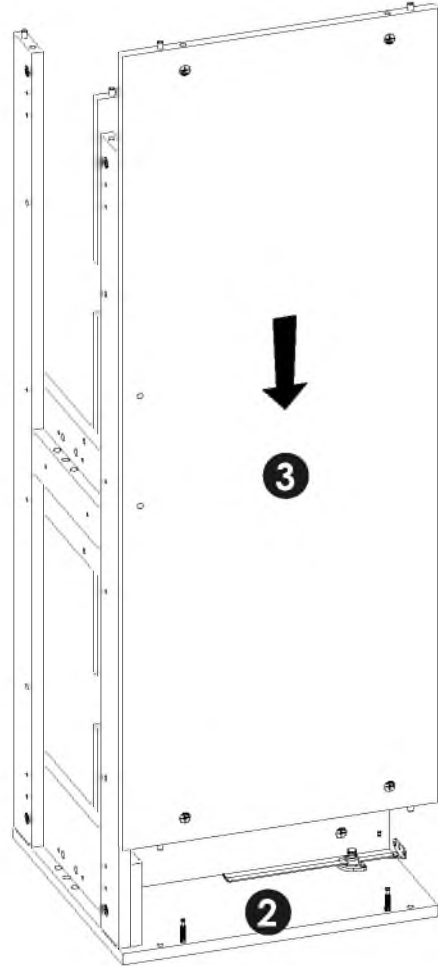
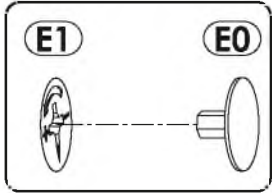
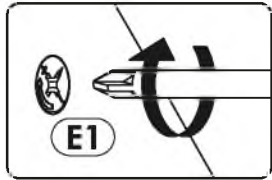
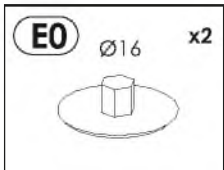
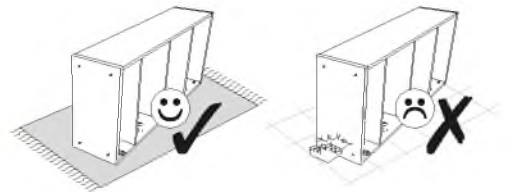

22 ▶

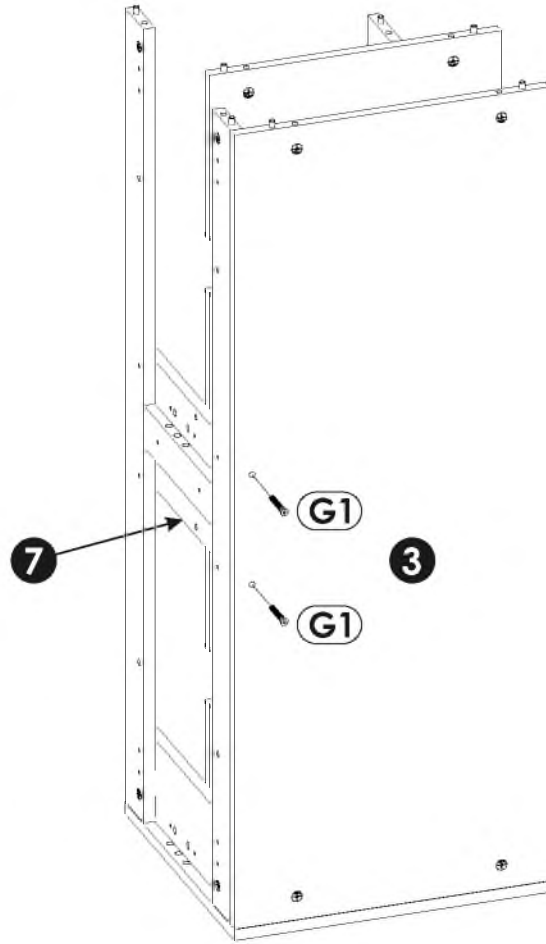
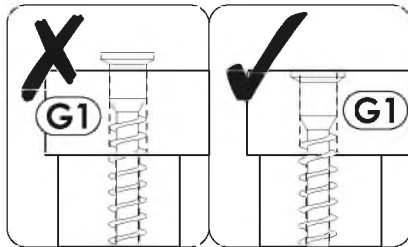
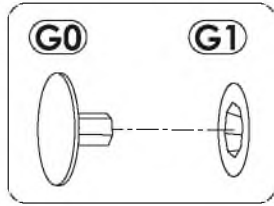
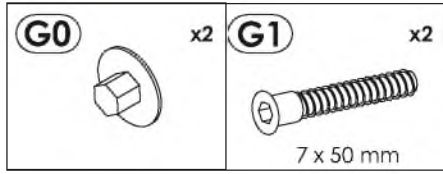
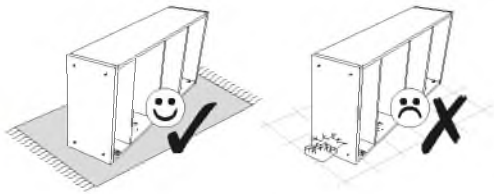

23 ▶

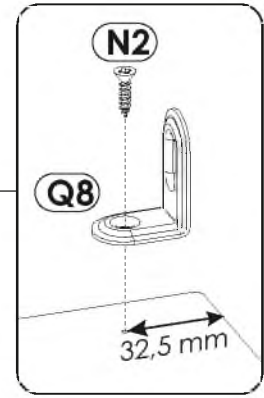
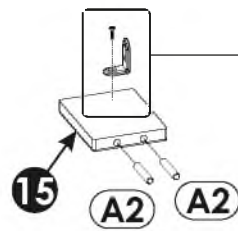
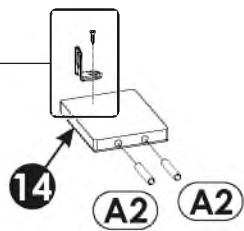
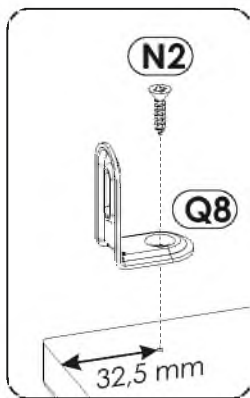
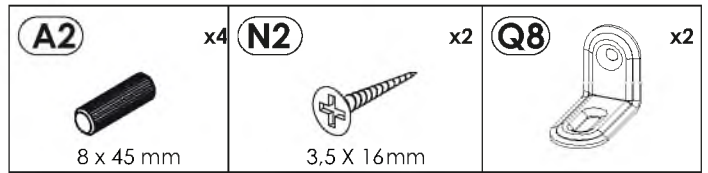

24 ▶

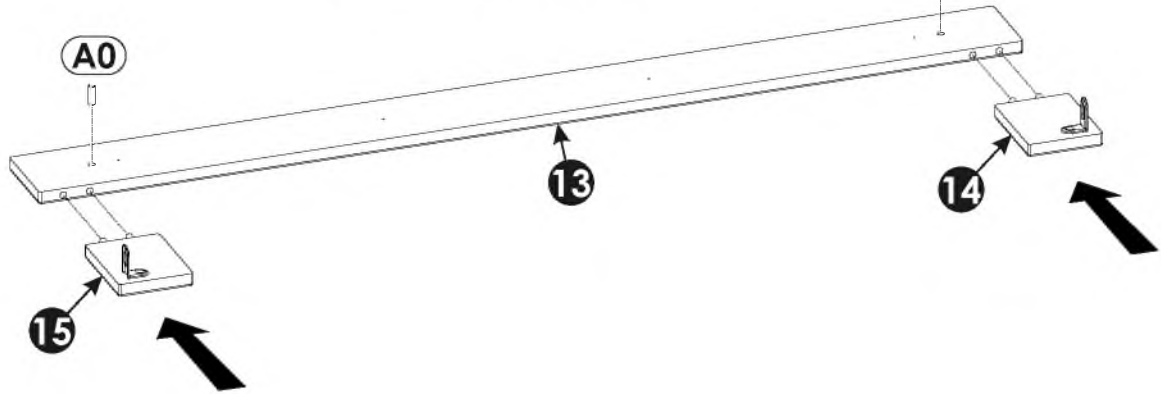
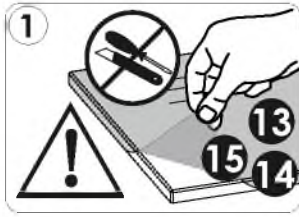
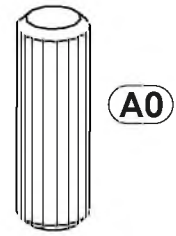
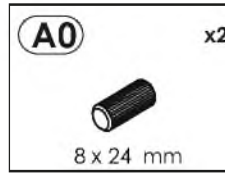
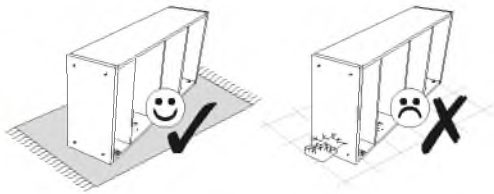

25 ▶

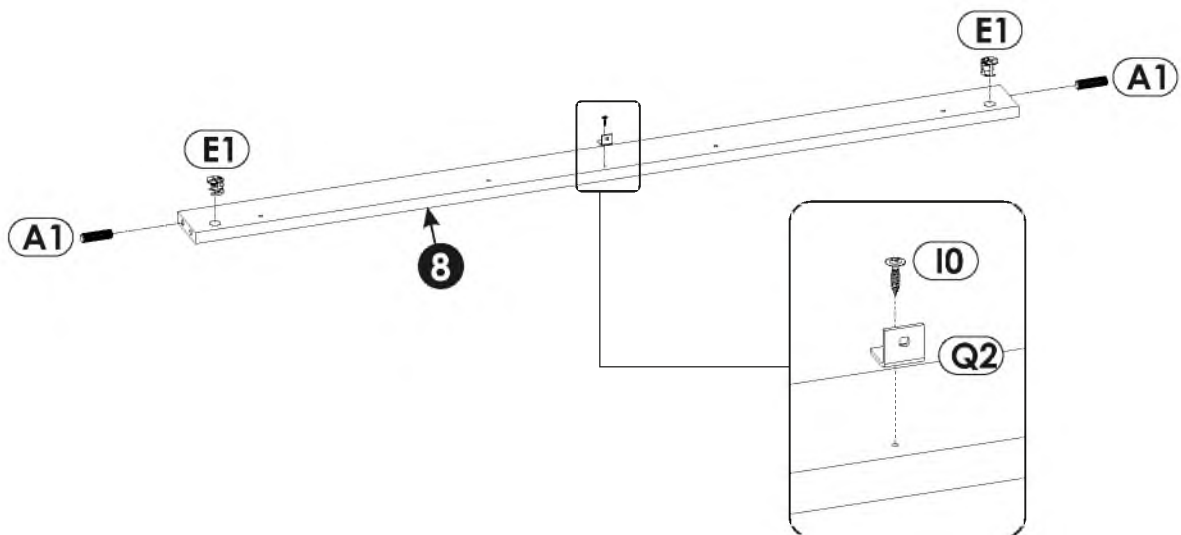
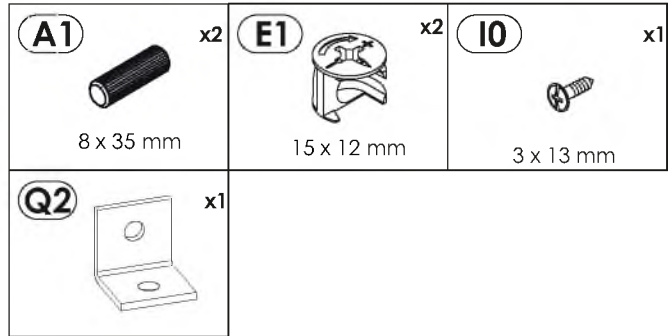
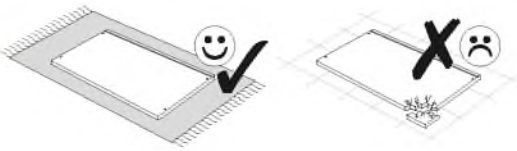

26 ▶

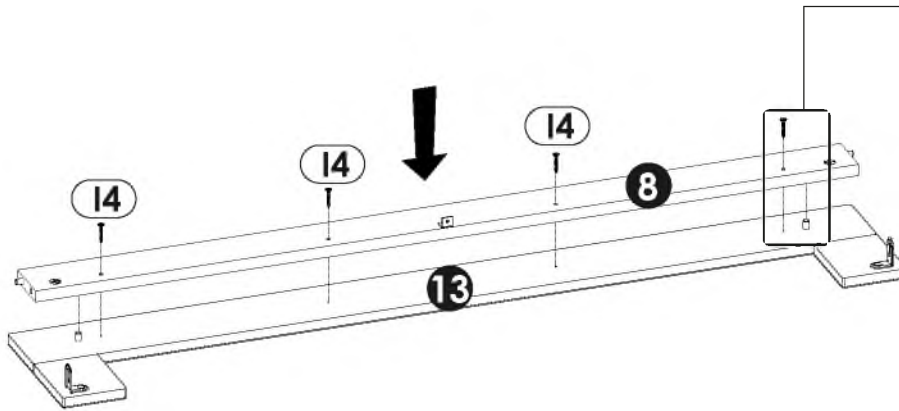
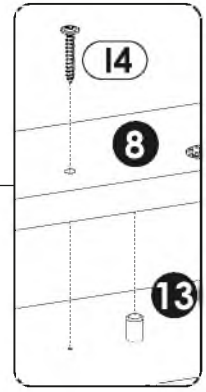
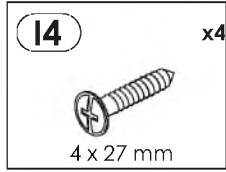
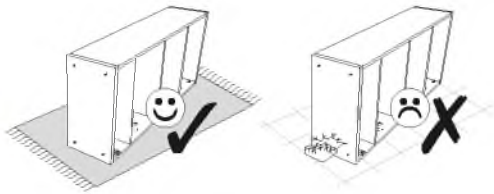

27 ▶

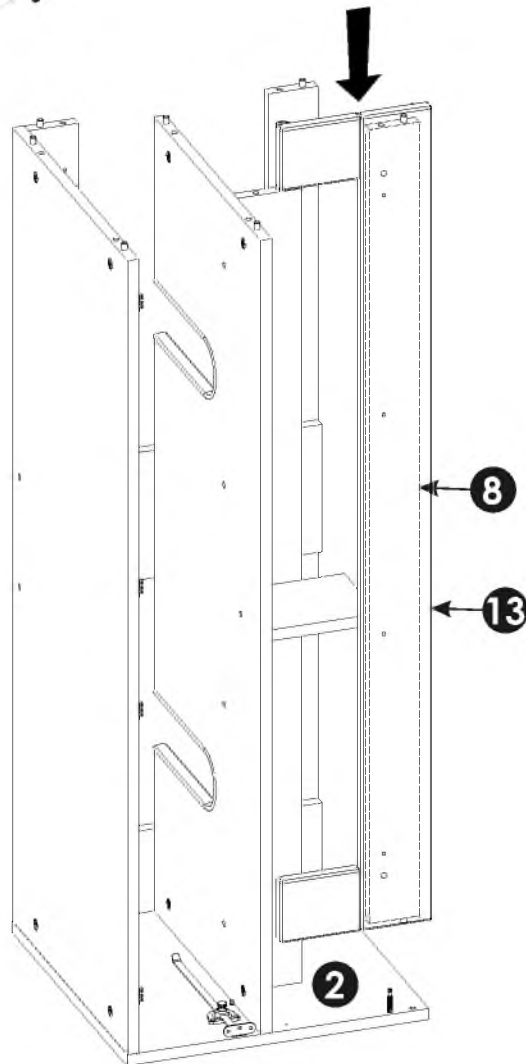
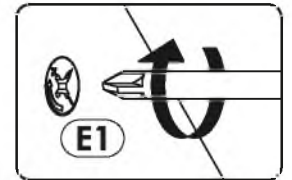
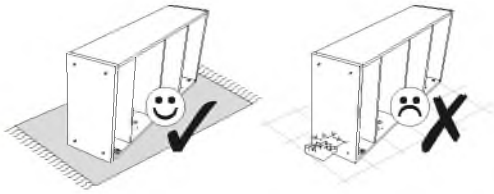

28▶

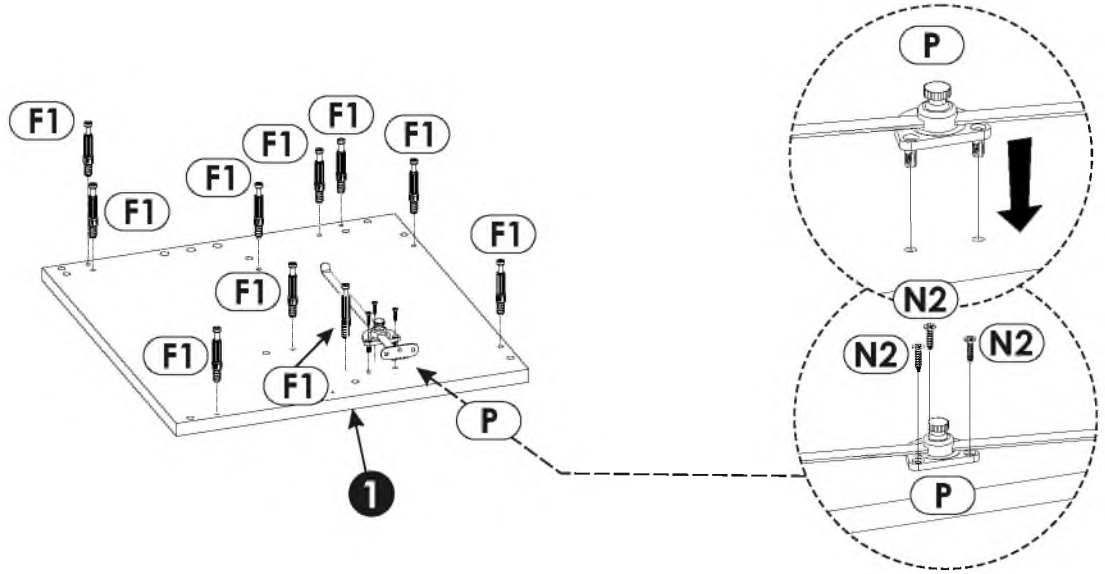
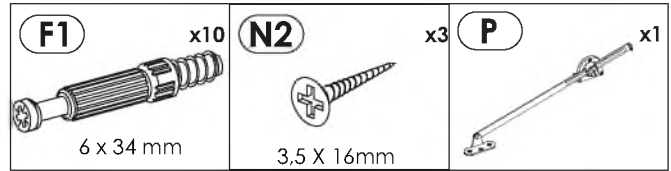

29▶

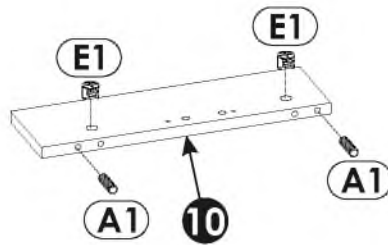
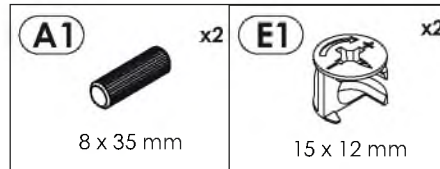

30 ▶

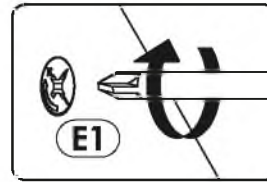
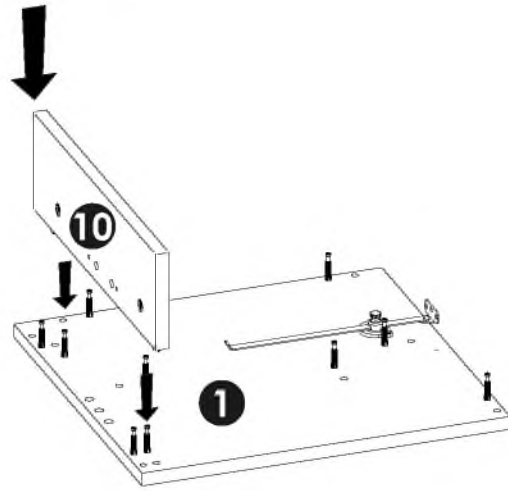
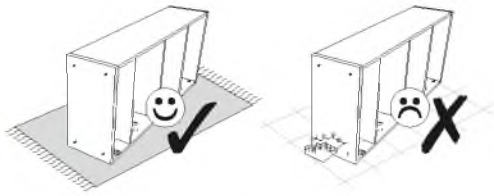

31 ▶

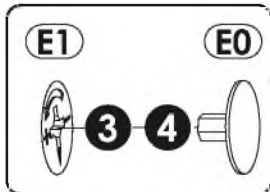
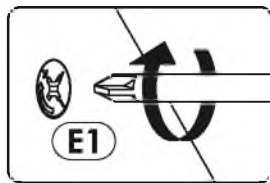
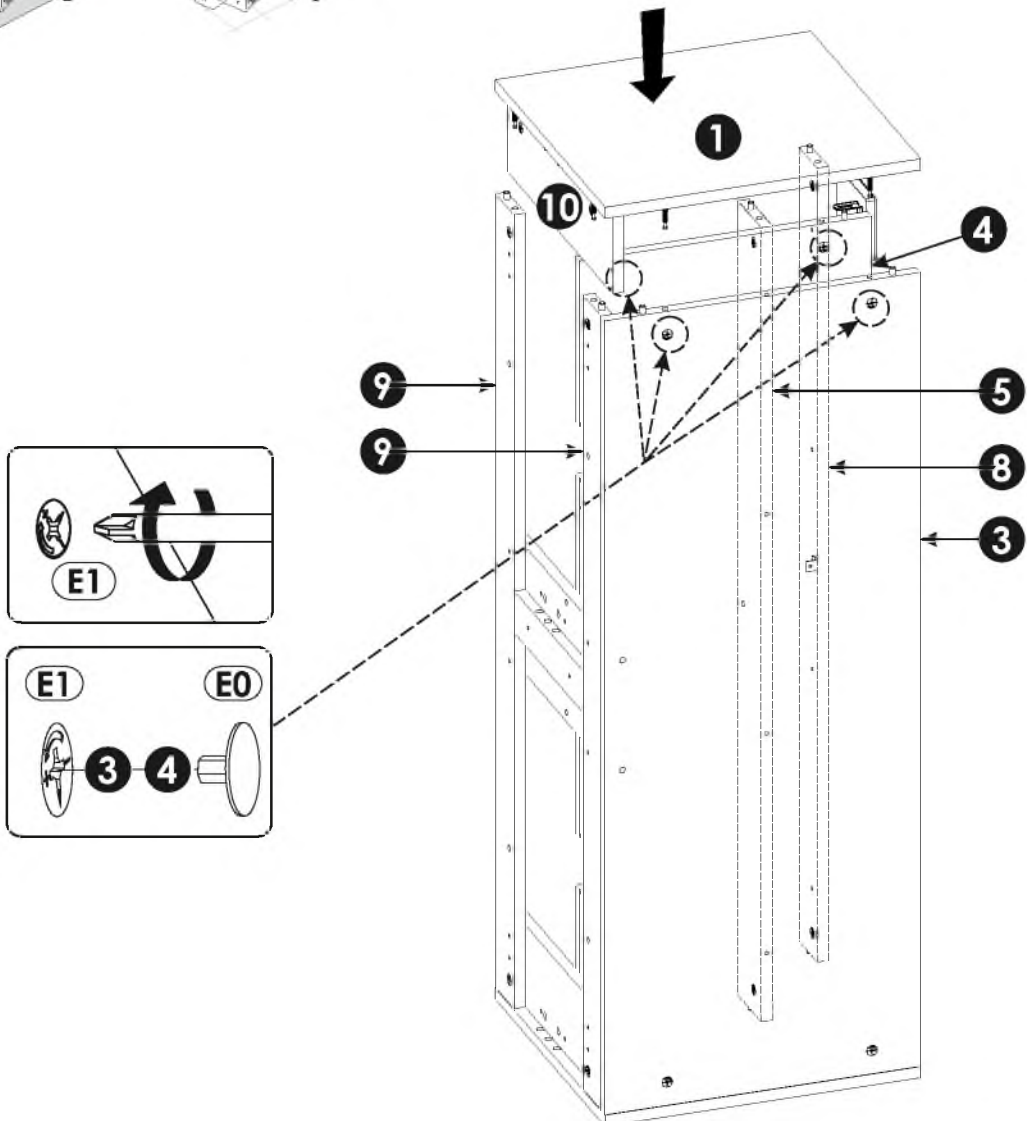
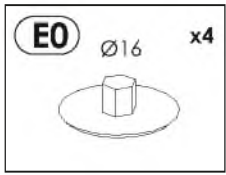
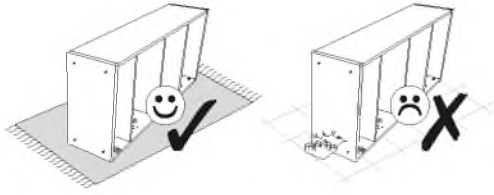

32 ▶

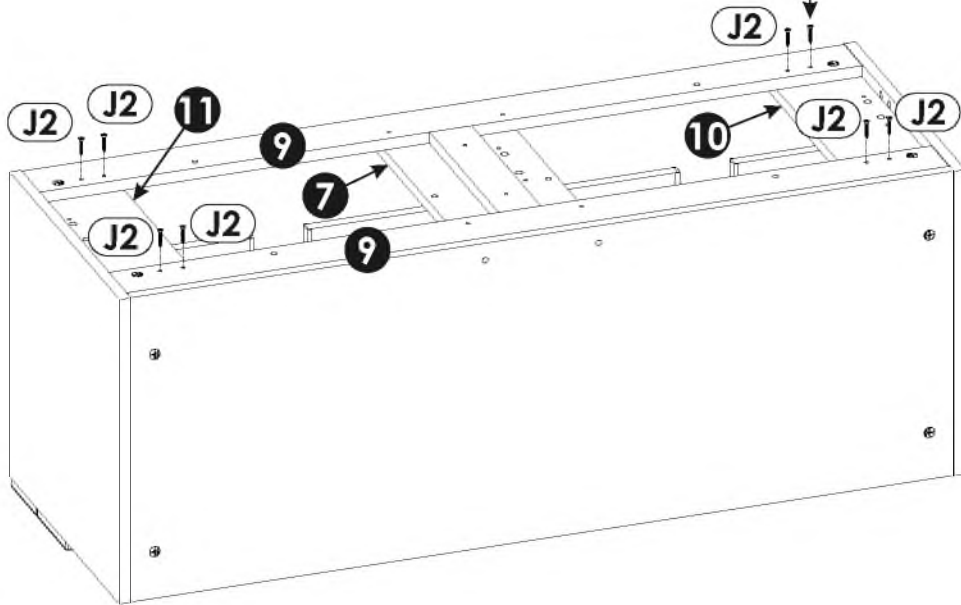
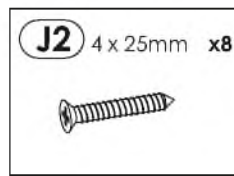
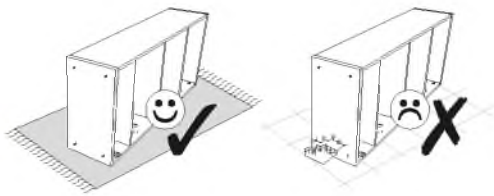

33 ▶

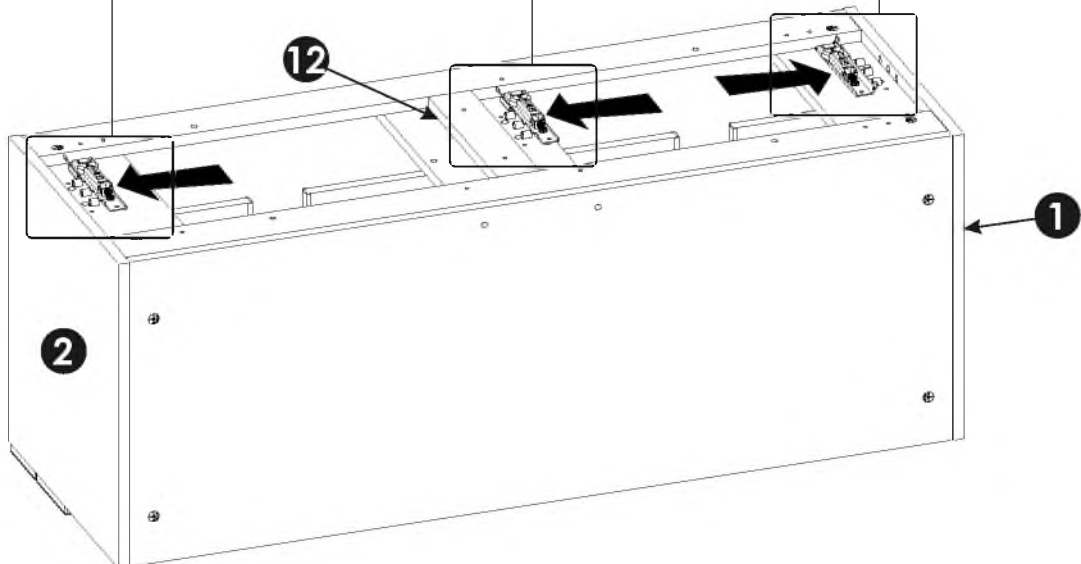
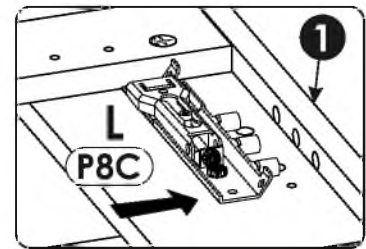
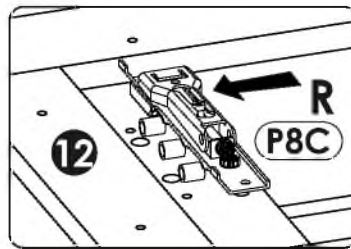
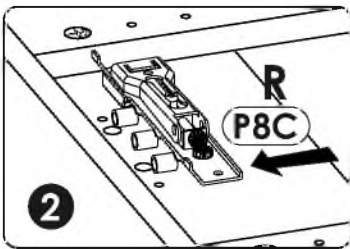
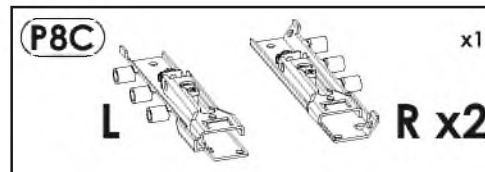
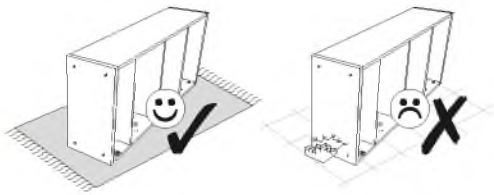

34 ▶

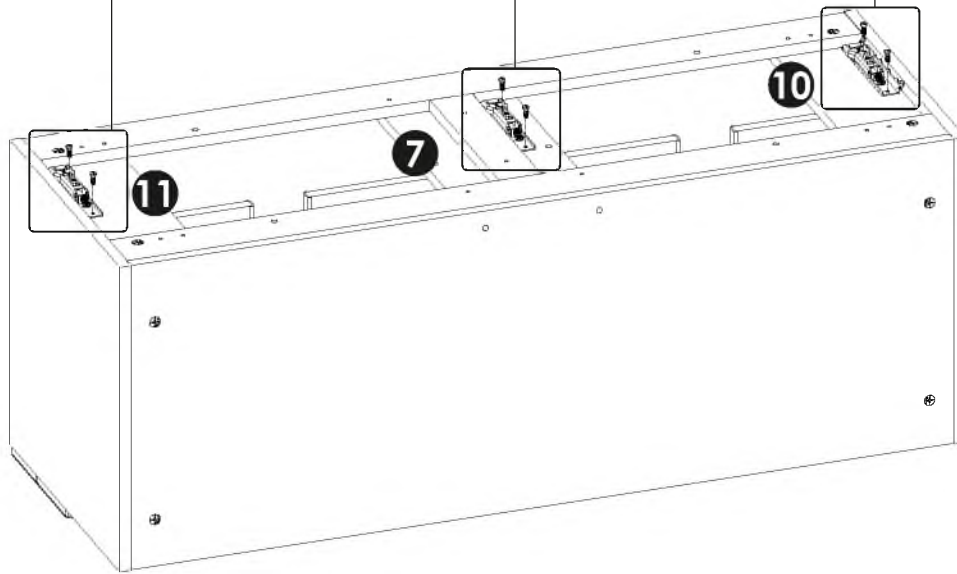
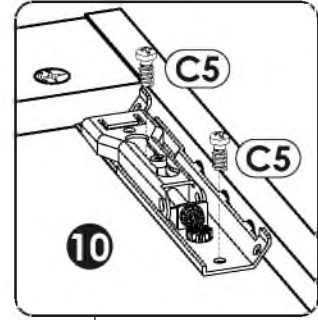
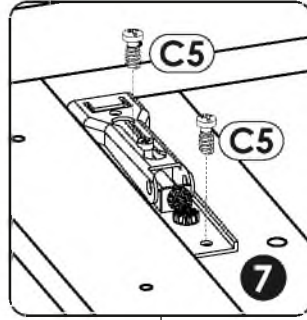
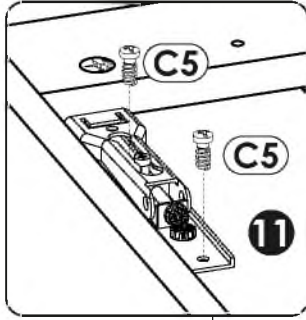
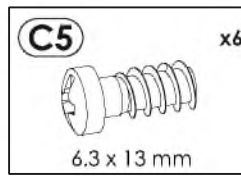

35 ▶

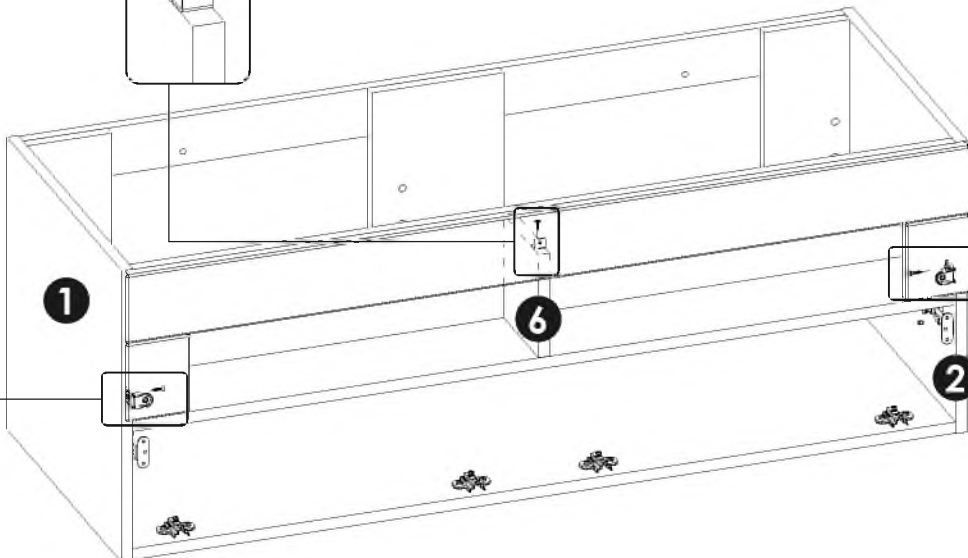
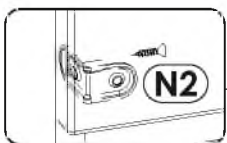
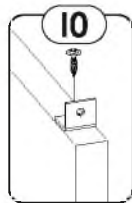
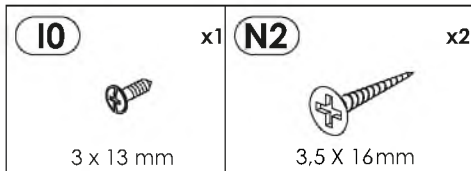

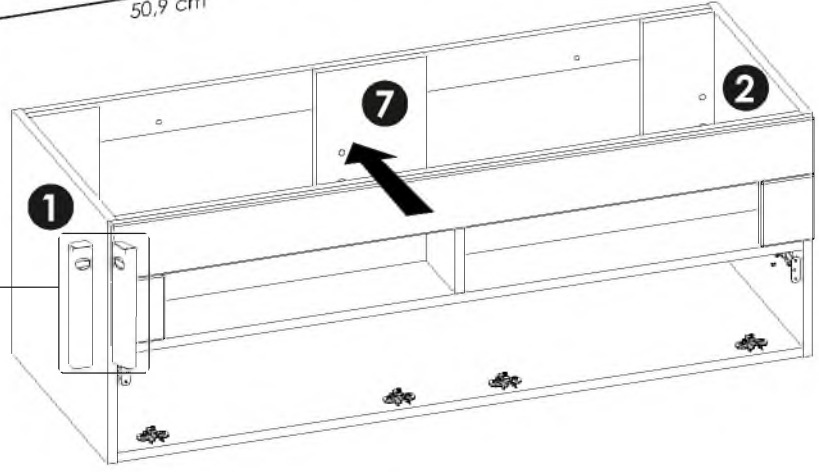
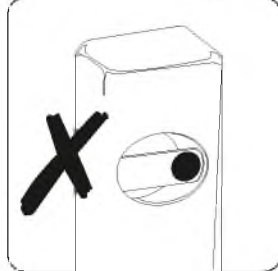
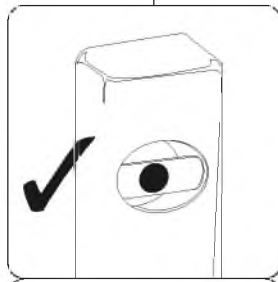
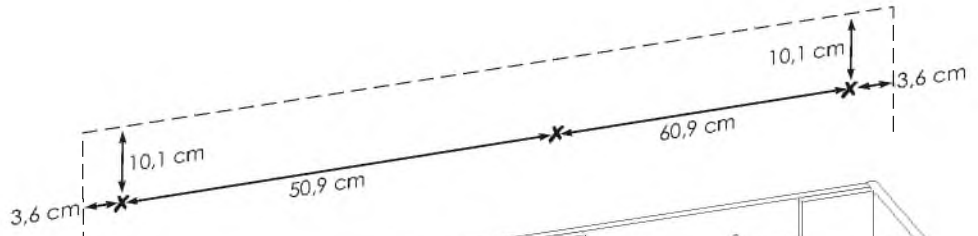
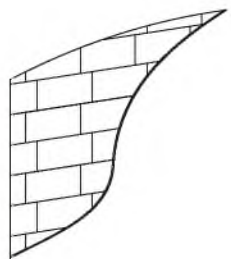
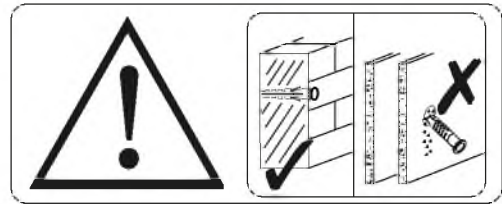

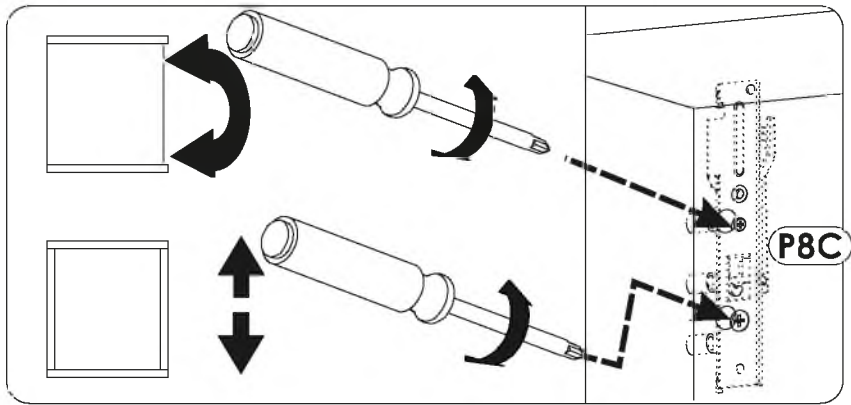
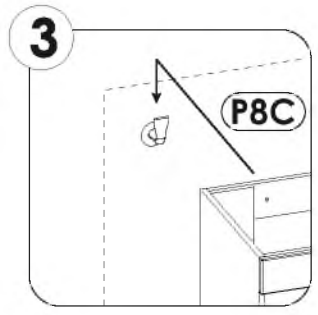
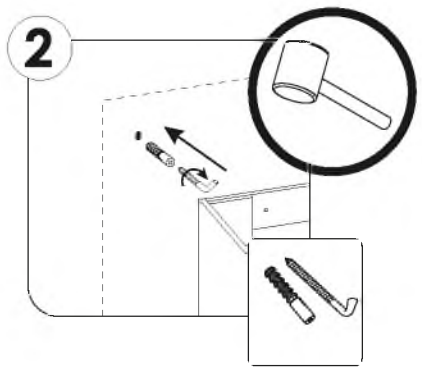
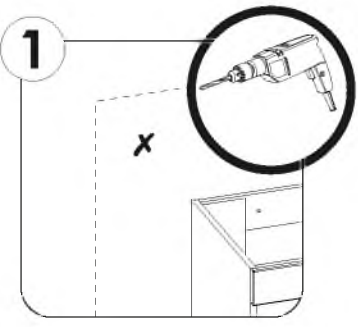

i

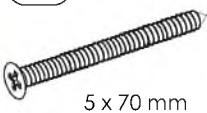

37 ▶

J16  5 x 70 mm	x2	P3  ø10	x6	P0  ø8	x2
--	----	---	----	--	----

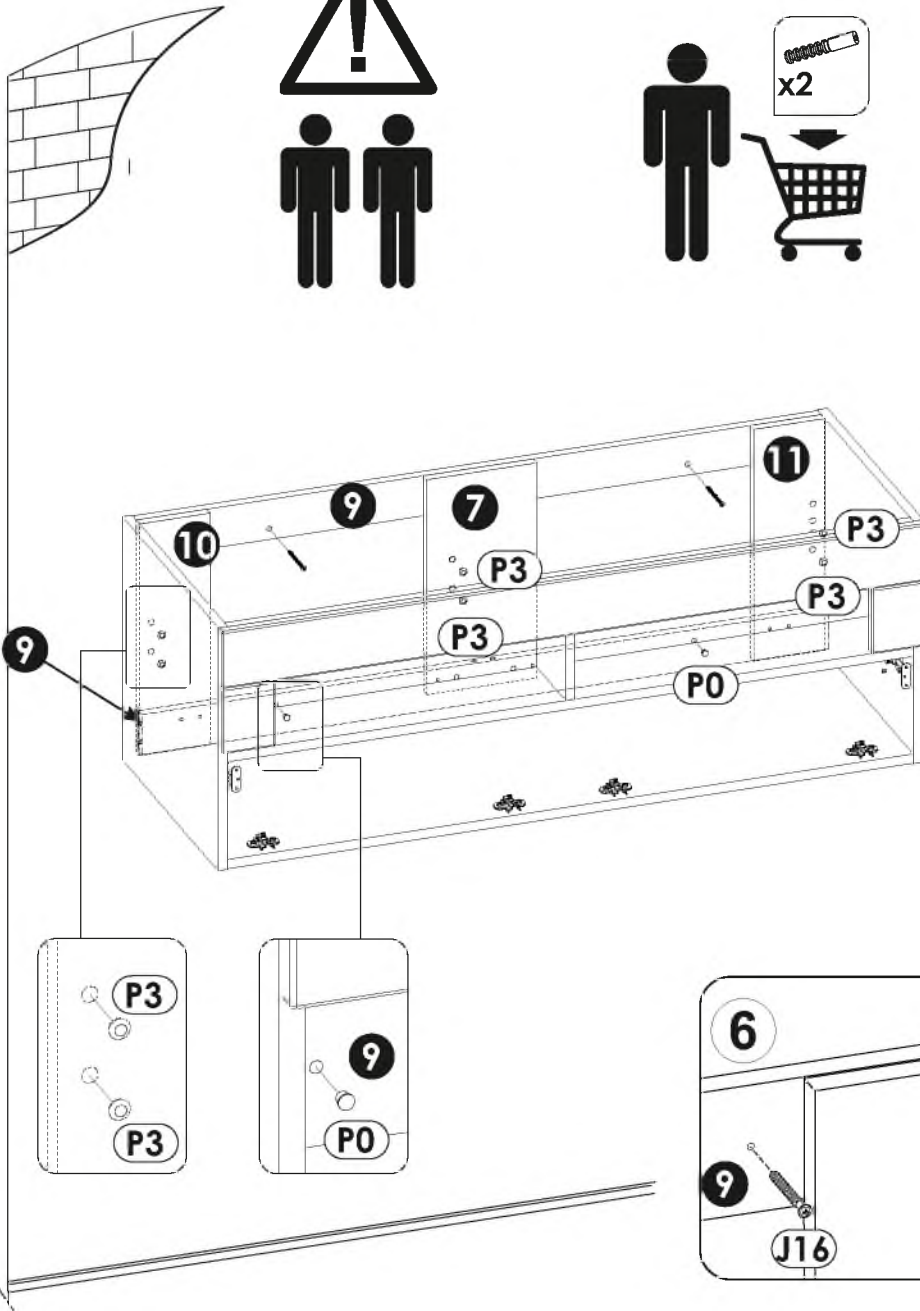
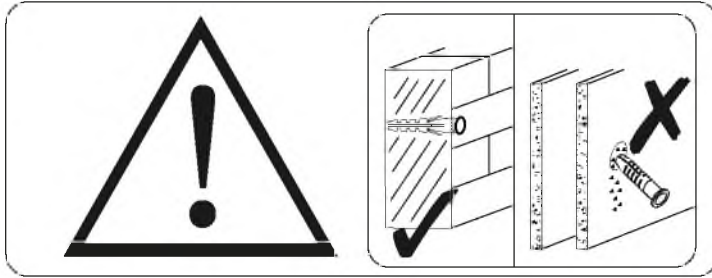
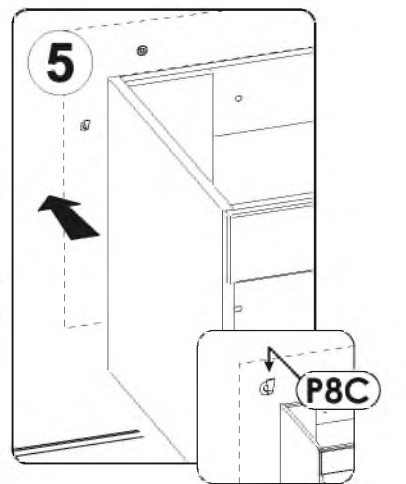
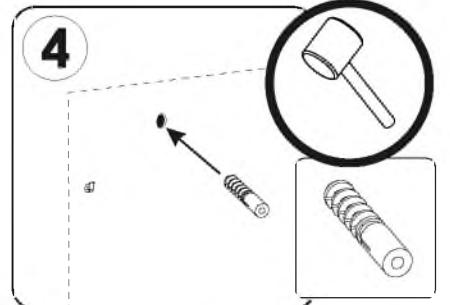
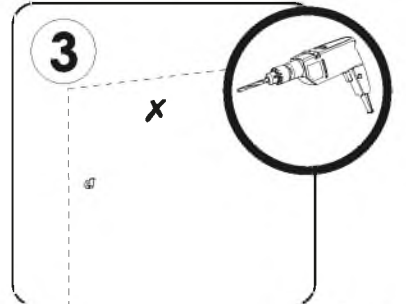
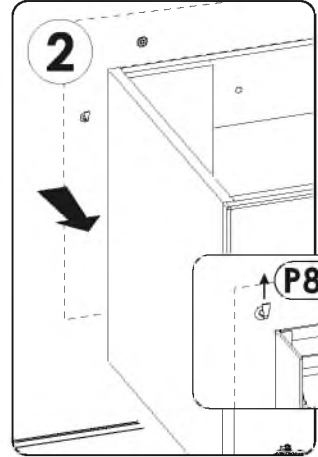

38 ▶

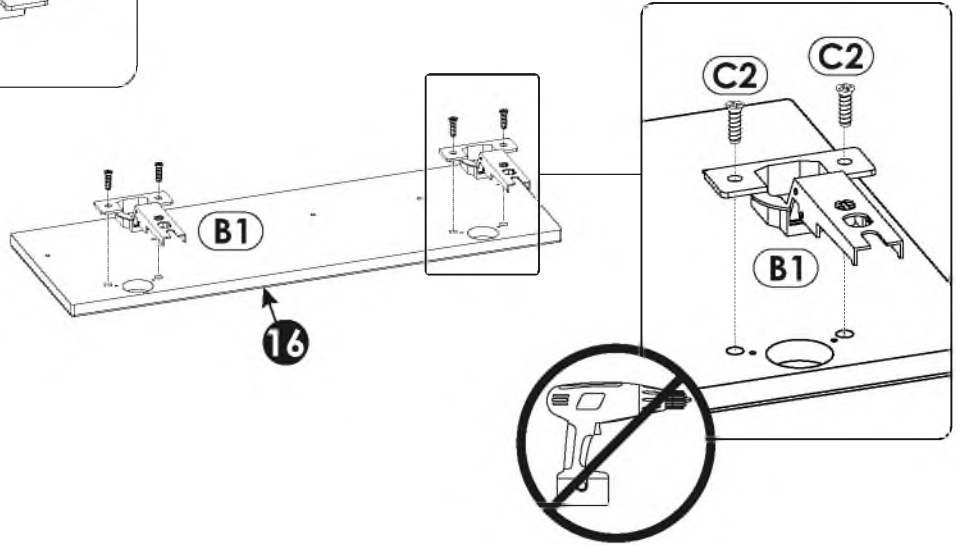
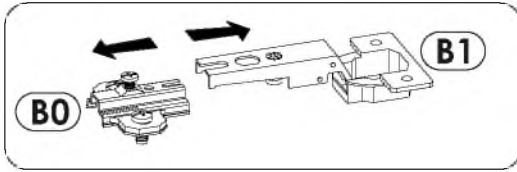
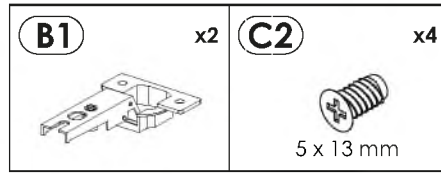
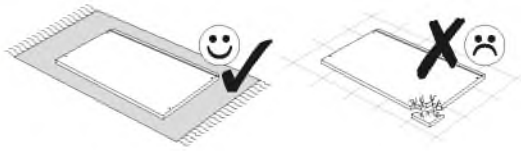

39 ▶

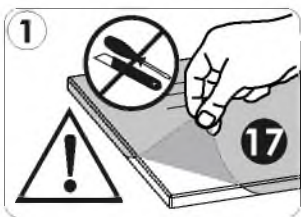
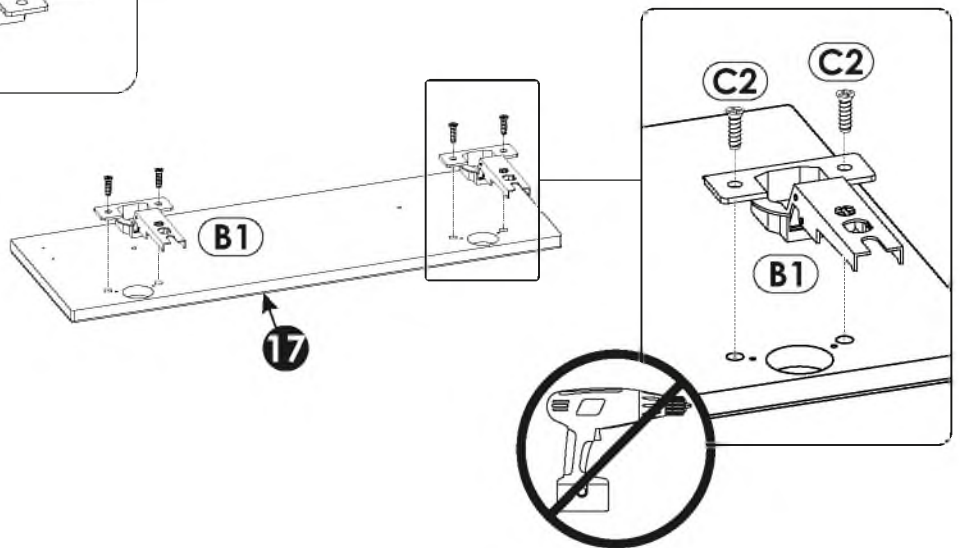
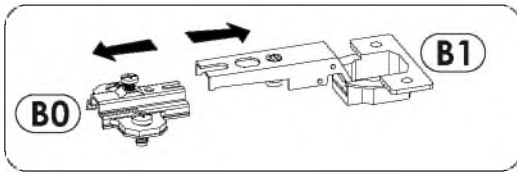
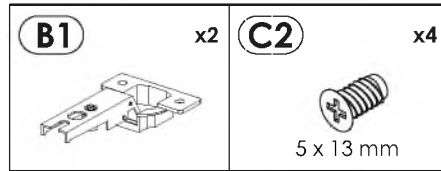

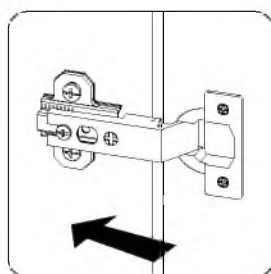
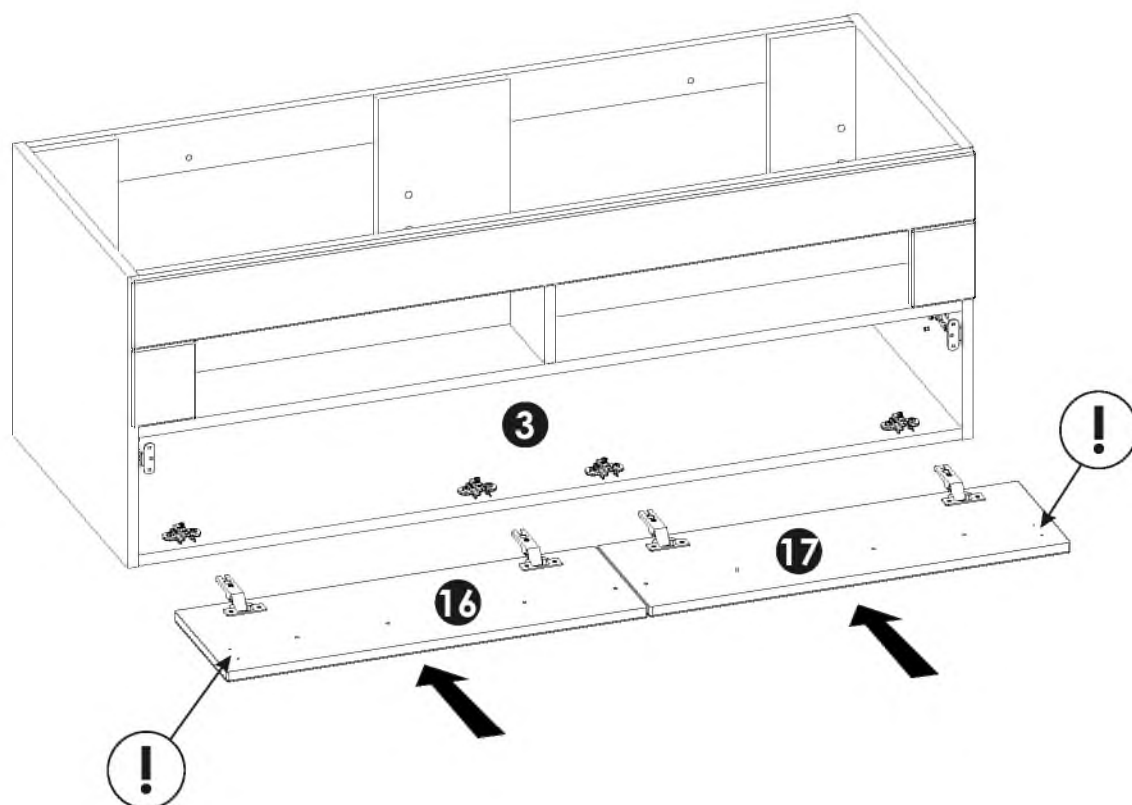

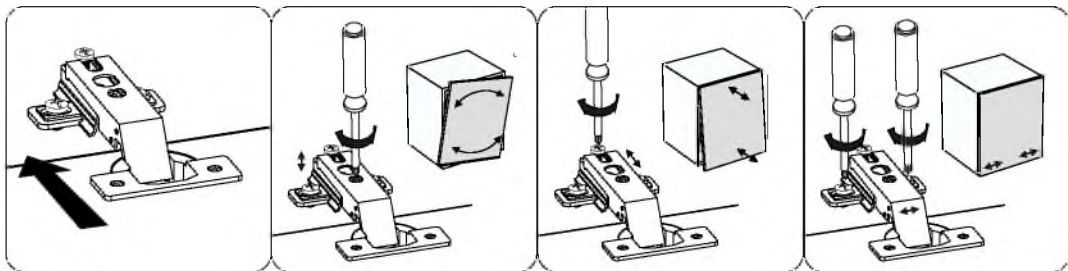
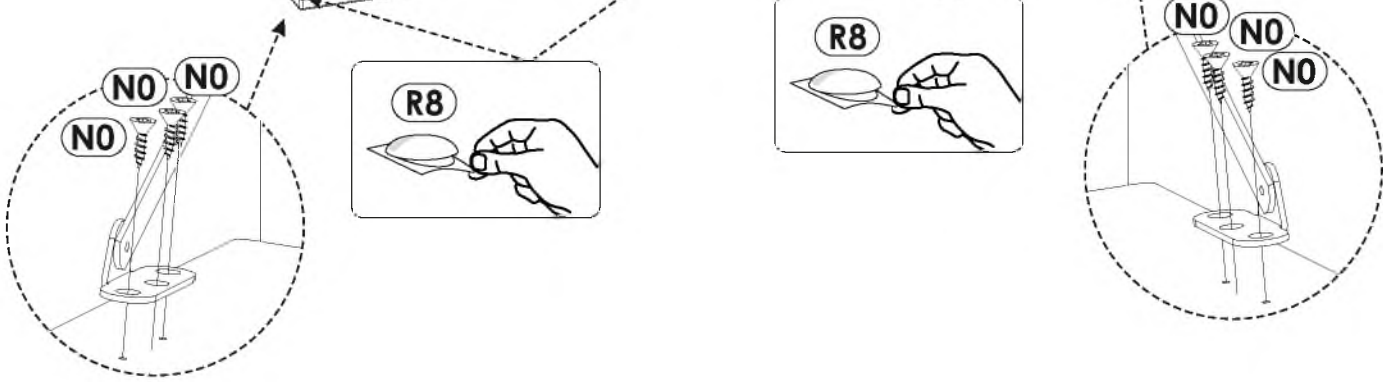
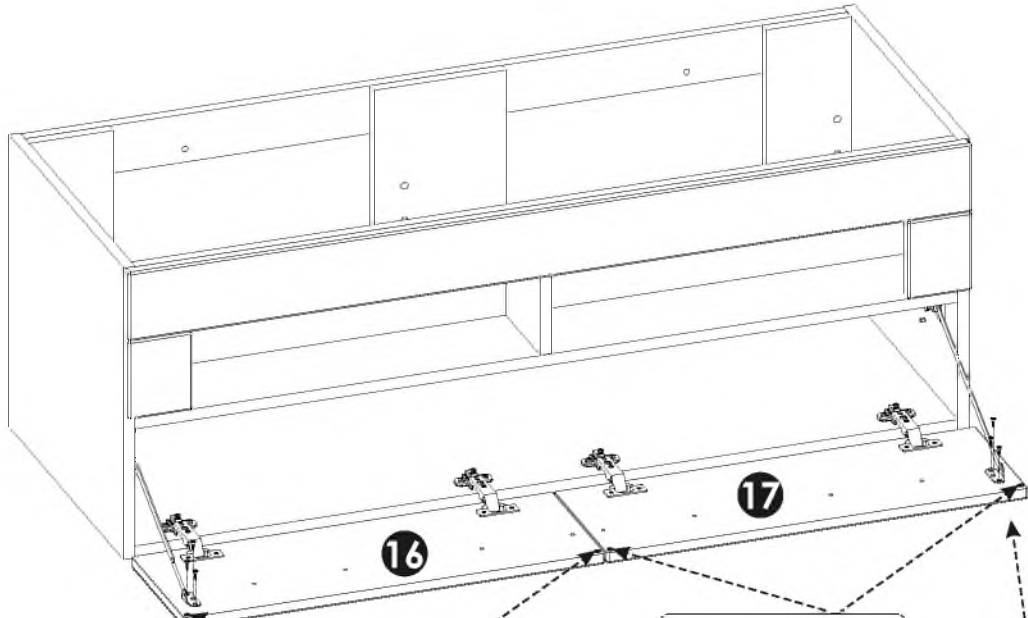
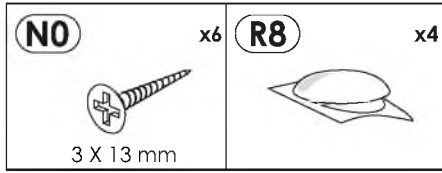

41 ▶



42 ▶

H1	x2	16	x8
			
L - 478 mm		3,5 x 27 mm	

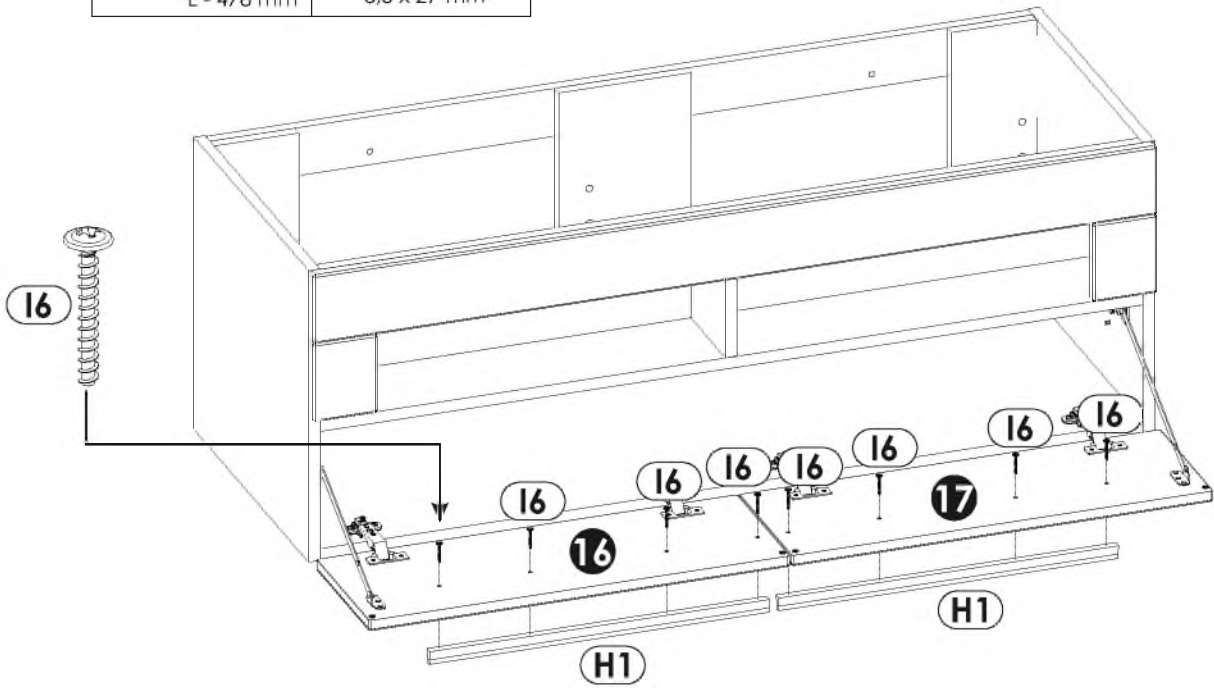

43 ▶

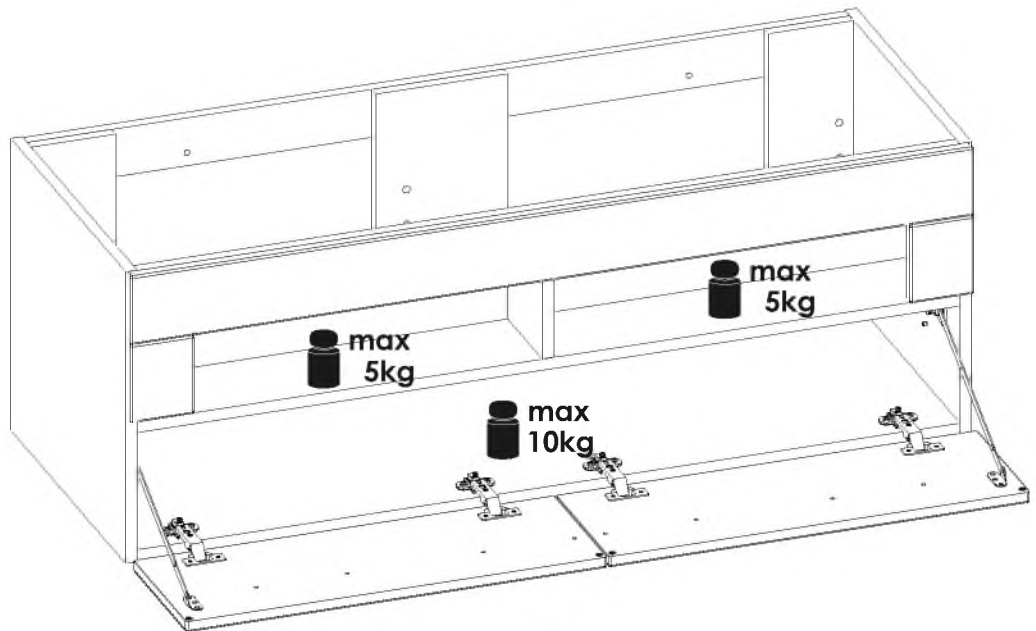

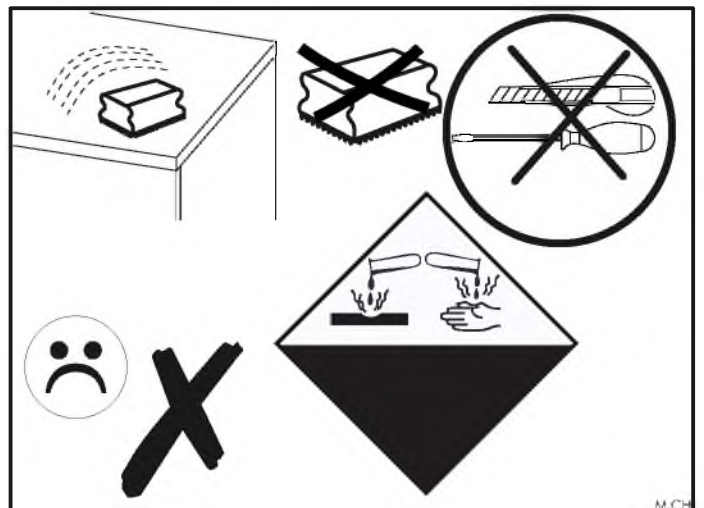
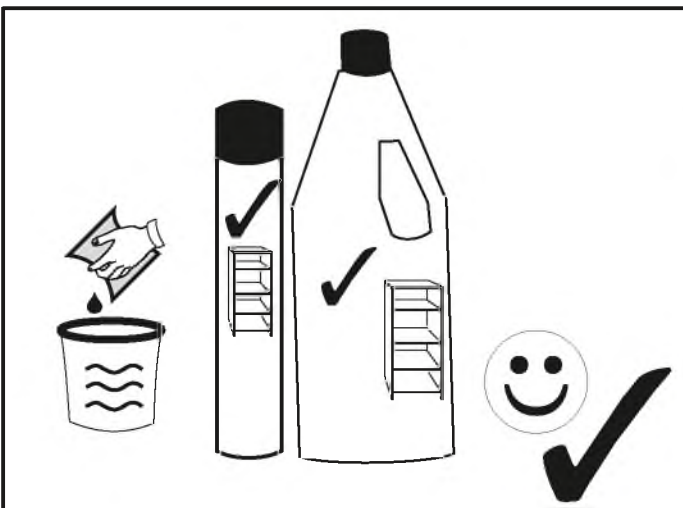
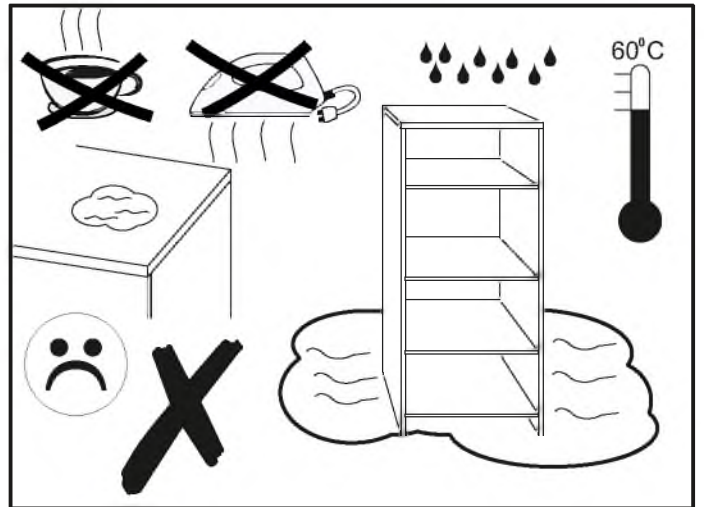
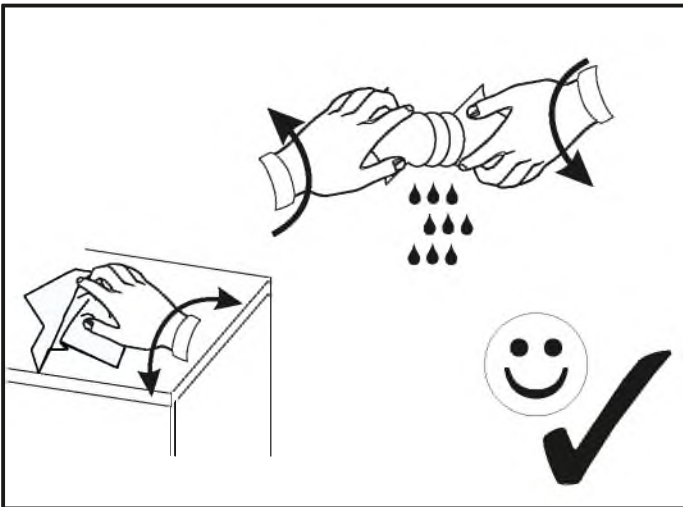
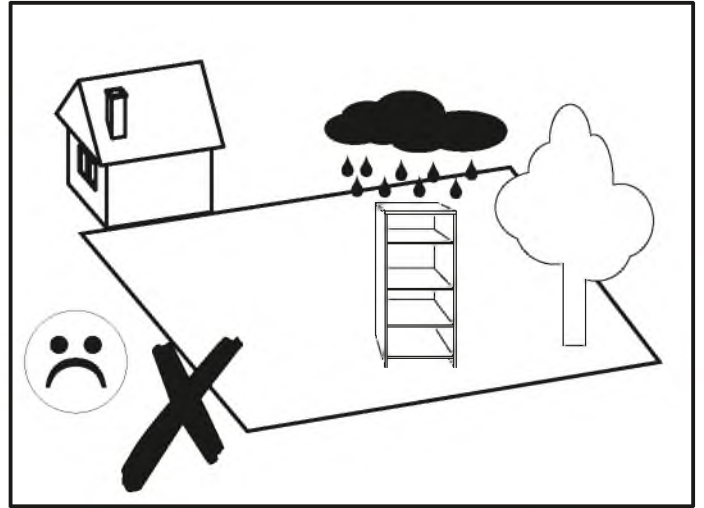
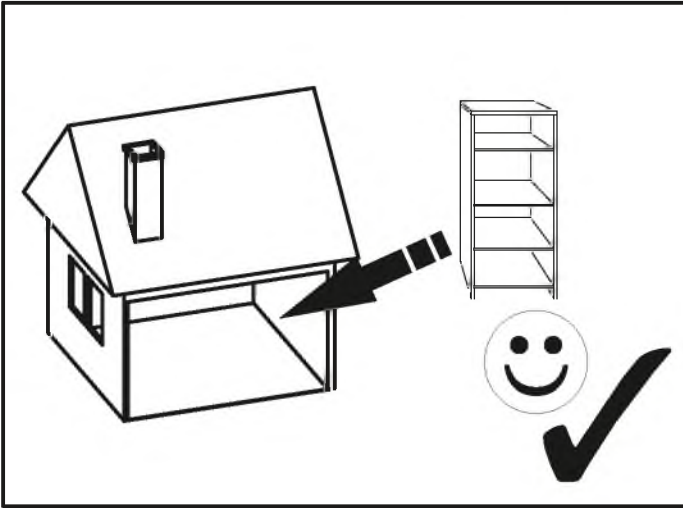
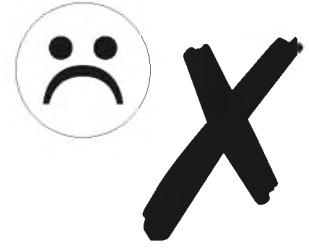

Waschtischbecken BW TB AM 12 00



24 h



WASCHBECKEN 120 (465x1200)

D Anleitung

NL Handleiding

F Manuel

IT Istruzioni

GB Instruction manual

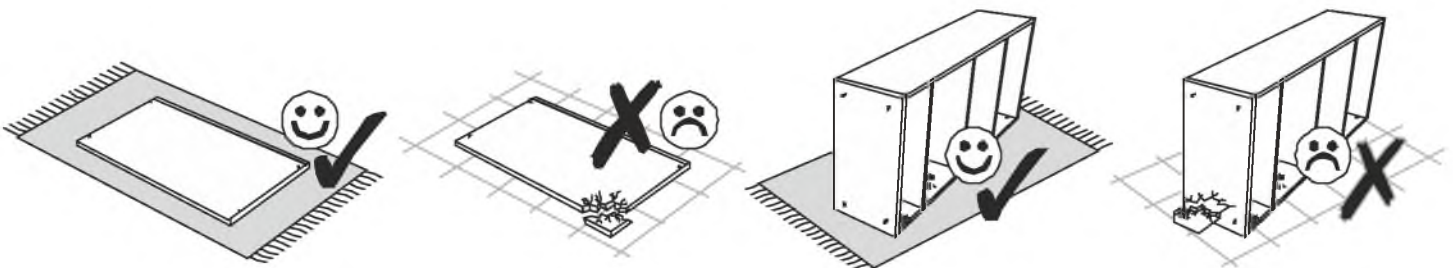
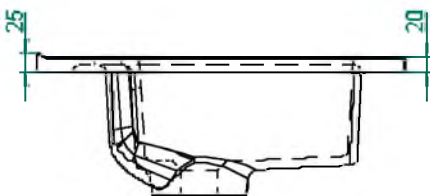
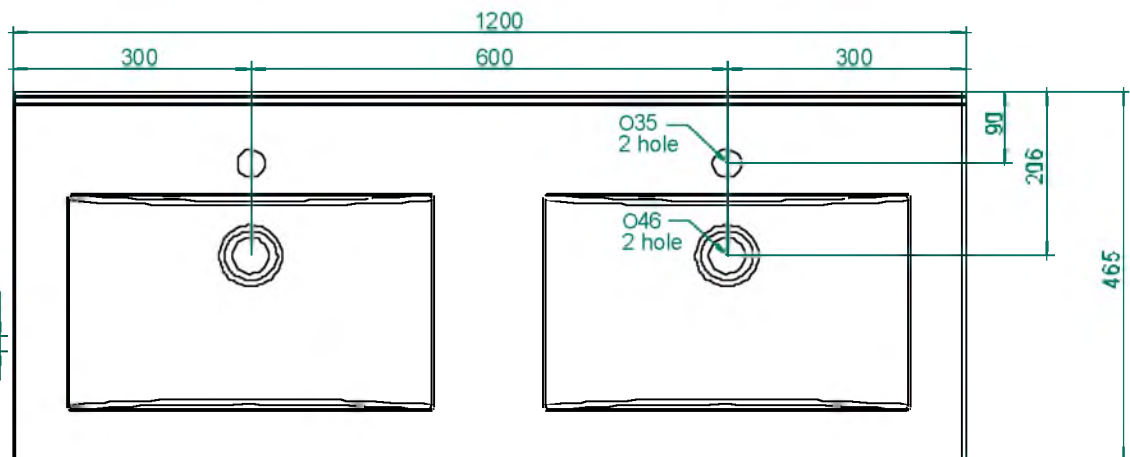
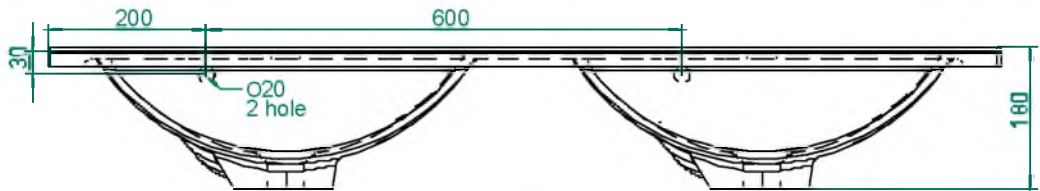

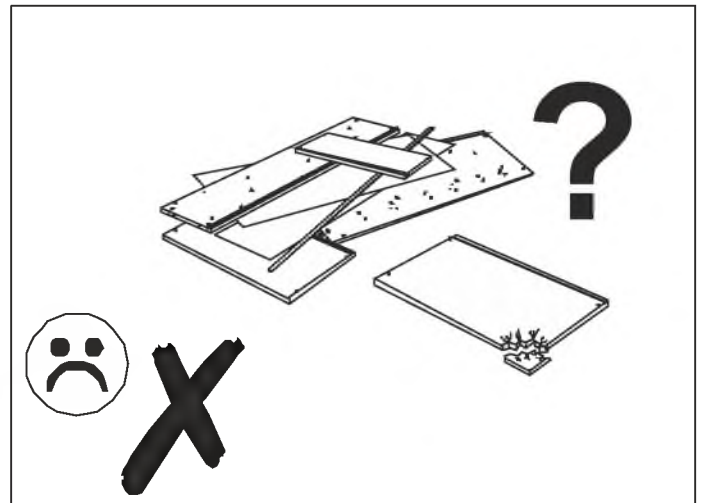
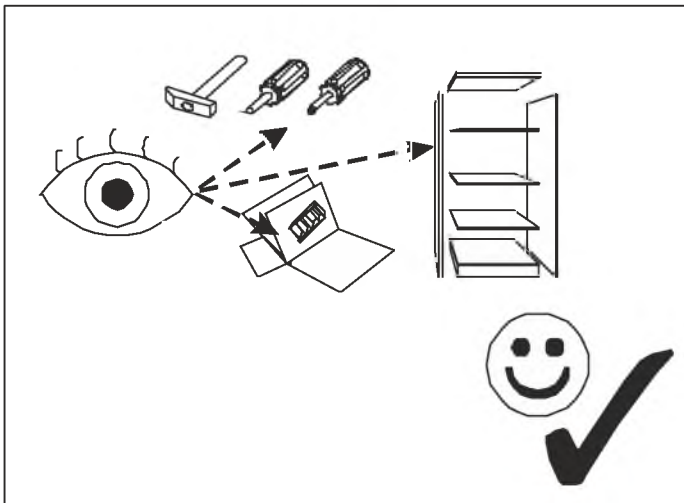
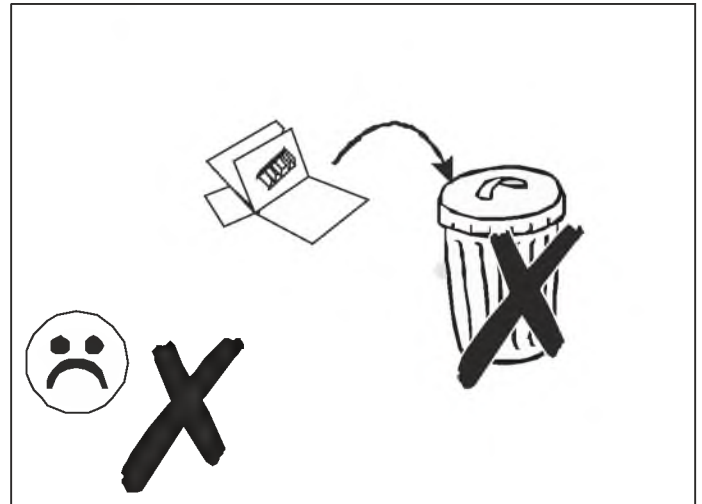
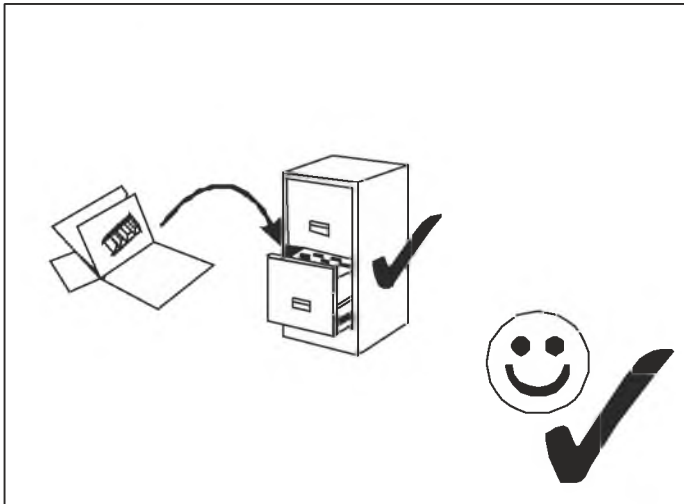
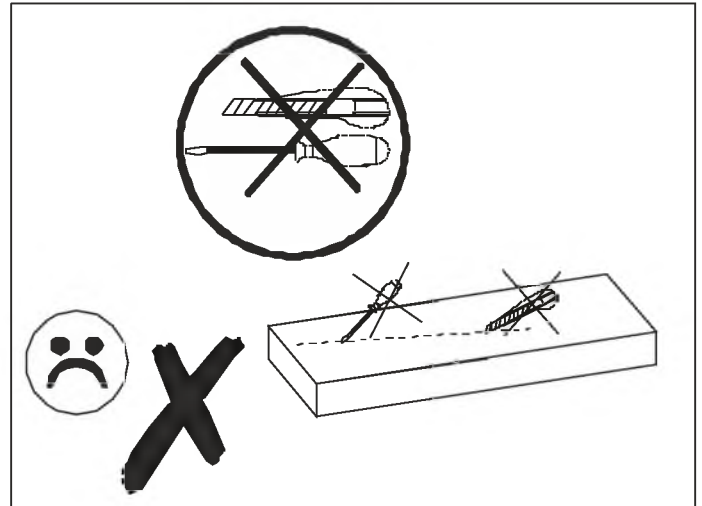
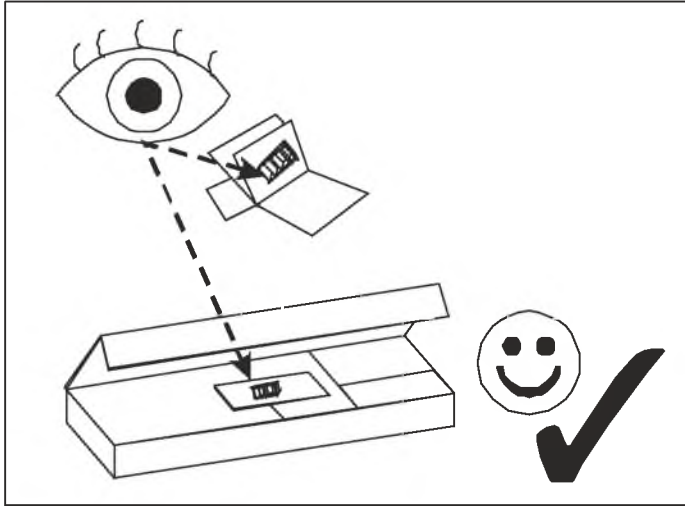

WICHTIG, FÜR SPÄTERE BEZUGNAHME DIESES DOKUMENT AUFBEWAHREN! SORGFÄLTIG LESEN!

Bestimmungsgemäßer Gebrauch

- Diesen Artikel nur für die persönliche Hygiene verwenden. Er ist nicht als Letterersatz, Sitzgelegenheit, Unterstellbock oder Turngerät für Kinder geeignet.
- Dieser Artikel ist nur zum Einsatz im privaten Bereich bestimmt.



Sicherheitshinweise

- **Erstickungs- / Verletzungsgefahr!** Lassen Sie Kinder nicht mit der Verpackung spielen. Sie könnten an der Folie ersticken oder sich an der Umverpackung verletzen.
- Achten Sie darauf, dass Kinder keine kleinen Teile, wie z. B. Muttern, Abdeckkappen oder Ähnliches in den Mund nehmen. Sie könnten sie verschlucken und daran ersticken.
- Der Artikel darf nur von fachkundigen Personen montiert werden.
- **Verletzungsgefahr!** Der Artikel ist kein Kinderspielzeug. Wenn sich Kinder an den Artikel hängen, könnte er aus der Wand herausgerissen werden und die Kinder könnten sich dabei verletzen.
- Montieren Sie den Artikel nur an einer geeigneten, massiven Wand.
- **Achtung:** Die Befestigung des Möbelstückes an der Wand muss von einer fachkundigen Person vorgenommen werden, da für die Montage an die Wand angepasste Dübel erforderlich sind.
- Stellen Sie sicher, dass sich keine Kabel oder Rohrleitungen in den Bohrbereichen befinden.
- Prüfen Sie die Bereiche vor dem Bohren mit einem Metalluchgerät.
- Die Materialien zur Wandmontage sind nicht im Lieferumfang enthalten und im Fachmarkt käuflich zu erwerben.

Pflegehinweise

Entfernen Sie Verunreinigungen mit einem leicht angefeuchteten Tuch. Verwenden Sie keinesfalls aggressive oder Lösemittel enthaltende Reinigungsmittel. Diese könnten die Oberflächen beschädigen.

BELANGRIJK, BEWAREN VOOR LATERE REFERENTIE! ZORGVULDIG DOORLEZEN!

Reglementair gebruik

- Dit artikel enkel voor de persoonlijke hygiëne gebruiken. Het is niet geschikt als vervanging voor een ladder, een opstap of burntoestel voor kinderen.
- Dit artikel is alleen bestemd voor privégebruik.



Veiligheidsinstructies

- **Verstikkings- / verwondingsgevaar!** Laat kinderen niet met de verpakking spelen. Ze kunnen stikken in de folie of zich aan de verpakking bezeren.
- Zorg ervoor dat kinderen geen kleine stukken, zoals moeren, afdekkapjes of dergelijke in de mond nemen. Ze kunnen ze inslikken en daardoor stikken.
- Het artikel mag alleen door vaklui worden gemonteerd.
- **Gevaar voor verwondingen!** Het artikel is geen speelgoed voor kinderen. Als kinderen aan het artikel gaan hangen, kan het uit de muur worden losgetrokken en de kinderen kunnen zich daarbij bezeren.
- **Monteer het artikel alleen op een geschikte, massieve muur.**
- **Opgelet:** een vakkundige persoon dient het meubelstuk aan de muur te bevestigen; voor de montage aan de muur zijn immers aangepaste pluggen vereist.
- Controleer of er in de gebieden waar u gaat boren zich geen snoeren of leidingen bevinden.
- Controleer de muren voor het boren niet een leidingenzoeker.
- Onderdelen ter bevestiging zijn niet inbegrepen in de levering en moeten in de vakwinkel worden gekocht.

Onderhoud

Verwijder vuil met een licht vochtige doek. Gebruik absoluut geen agressieve of oplosmiddelhoudende reinigingsmiddelen. Deze kunnen de oppervlakken beschadigen.

IMPORTANT : CONSERVER CE DOCUMENT POUR CONSULTATION ULTÉRIEURE ! À LIRE ATTENTIVEMENT !

Usage conforme

- Cet article ne doit être utilisé que pour l'hygiène personnelle. Ne convient pas pour une utilisation comme échelle, pour s'asseoir, comme support ou autre appareil de gymnastique pour enfant.
- Cet article est uniquement destiné à un usage privé.



Consignes de sécurité

- Risque d'asphyxie/de blessure! Ne laissez pas les enfants jouer avec l'emballage. Ils pourraient s'asphyxier avec le film ou se blesser avec les habillages de l'emballage.
- Veillez à ce que les enfants ne mettent aucune petite pièce, comme p. ex. des érous, des capuchons ou similaires, dans la bouche. Ils peuvent les avaler et s'étouffer.
- L'article ne pourra être assemblé que par des personnes s'y connaissant.
- Risque de blessure! L'article n'est pas un jouet. Si des enfants se pendent à l'article, il pourrait alors être arraché du mur et les enfants pourraient se blesser.

- Installez l'article uniquement à un mur massif qui convient.

- Attention : La fixation du meuble contre le mur doit être effectuée par une personne compétente car, pour le montage mural, il faut utiliser des chevilles adaptées.

- Assurez-vous qu'aucun câble ni conduite se trouve dans les endroits où vous percez.
- Avant de percer, vérifiez les endroits avec un appareil de détection du métal.

- Les pièces servant à la fixation ne sont pas fournies. Celles-ci sont en vente dans les magasins spécialisés.

Consignes d'entretien

Enlevez les saletés avec un chiffon légèrement humide. N'utilisez en aucun cas des détergents contenant des produits agressifs ou des solvants. Ceux-ci pourraient endommager les surfaces.

IMPORTANTE: CONSERVARE QUESTO DOCUMENTO PER LA SUCCESSIVA CONSULTAZIONE! LEGGERE ATTENTAMENTE!

Utilizzo conforme alla destinazione d'uso

- Utilizzare questo articolo solo per l'igiene personale.
- Il presente articolo è destinato soltanto all'uso in ambito domestico.



Norme di sicurezza

• Pericolo di soffocamento/di lesioni! Non permettere ai bambini di giocare con l'imballaggio. Correbbero il rischio di soffocamento a causa delle pellicole, o di lesioni a causa dell'imballaggio esterno.

- Assicurarsi che i bambini non portino alla bocca le parti piccole, ad es. dadi, copercapochi e simili. Potrebbero ingerirle e soffocare.

- L'articolo può essere montato solo da persona esperta.

- Pericolo di lesioni! L'articolo non è un giocattolo. Se i bambini vi si appendono, potrebbe staccarsi dalla parete e provocare lesioni.

- Montare l'articolo solo una parte idonea, massiccia.

- Attenzione: Il fissaggio del mobile alla parete deve essere eseguito da persone esperte, dato che occorrono tasselli adeguati.

- Assicurarsi che sui punti da trapanare non scorrano cavi o tubazioni.

- Prima di trapanare, ispezionare la zona interessata con un cerca metalli.

- Le parti per il fissaggio non sono contenute nella fornitura e si possono acquistare nei negozi specializzati.

Istruzioni di manutenzione

Rimuovere lo sporco con un panno leggermente umido. In nessun caso utilizzare detergenti aggressivi o a base di solventi, perché potrebbero intaccare le superfici.

IMPORTANT! KEEP THIS DOCUMENT FOR FUTURE REFERENCE! READ CAREFULLY!

Intended use

- This article is only meant to be used for personal hygiene. It is not intended for use as a ladder, seat, support or play equipment for children.
- This item is suitable for domestic use only.



Safety instructions

- Risk of suffocation/injury! Do not allow children to play with the packaging. They could suffocate in the packaging film or injure themselves on the outer packaging.
- Ensure that children do not put any small parts such as nuts, caps or the like in their mouth. They could swallow and choke on them.
- The item should be assembled by competent persons only.
- Risk of injury! This item is not a toy. If children hang from this item it could pull free from the wall and cause injury.
- Mount this item on a suitable wall surface only.
- Attention: A qualified professional is required when mounting furniture to the wall since dowels corresponding to the wall are required for this.
- Ensure that there are no cables or pipes where the holes are to be drilled.
- Check the area before drilling with a metal detector device.

Care information

Clean with a damp cloth. Never use any aggressive cleaning product or those containing solvents. These may damage the surface.

