

17801916, 45349647, 82701805, 39236613,  
65151868, 14530361, 82704151, 48171966

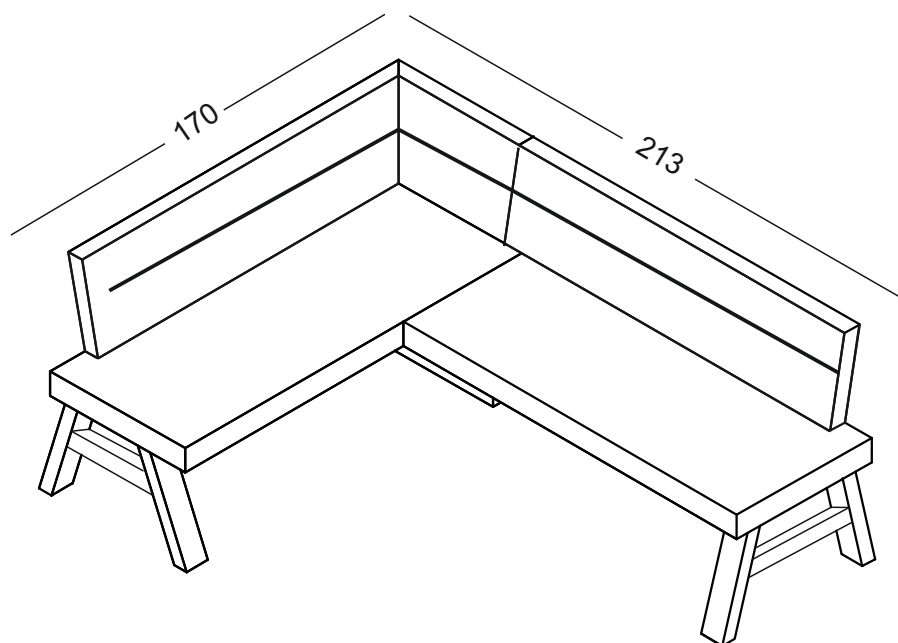

- |           |                                    |           |                                |
|-----------|------------------------------------|-----------|--------------------------------|
| <b>D</b>  | <b>Montageanleitung</b>            | <b>GB</b> | <b>Assembly instructions</b>   |
| <b>FR</b> | <b>Notice de montage</b>           | <b>IT</b> | <b>Istruzioni di montaggio</b> |
| <b>NL</b> | <b>Handleiding voor de montage</b> | <b>PL</b> | <b>Instrukcja montażu</b>      |
| <b>CZ</b> | <b>Montážní návod</b>              | <b>SK</b> | <b>Návod na montáž</b>         |
| <b>HU</b> | <b>Szerelési útmutató</b>          | <b>RO</b> | <b>Instrukțiuni de montaj</b>  |
| <b>TR</b> | <b>Montaj talimatı</b>             | <b>RU</b> | <b>Инструкция по монтажу</b>   |

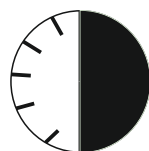
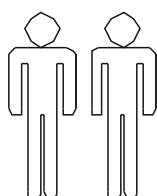

30 min

**LKZ040779**

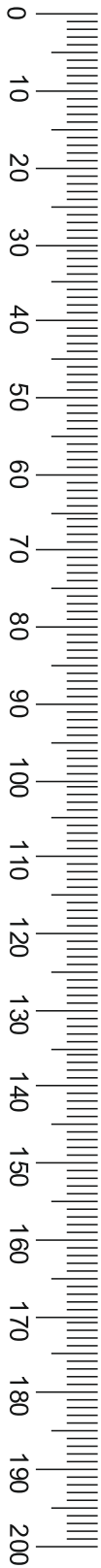

# Service . Assistenza . Dienstverlening . Serwis Servis . Szerviz

Name.Nom.Nome.Naam.  
Nazwa.Jmeno.Nazov.Nev  
Denumire.Isim

Nr.No.N.Homep.Č.Sz  
17801916, 45349647, 82701805,  
39236613, 65151868, 14530361,  
82704151, 48171966

Typ . Type . Tip . Tipus . Tipo

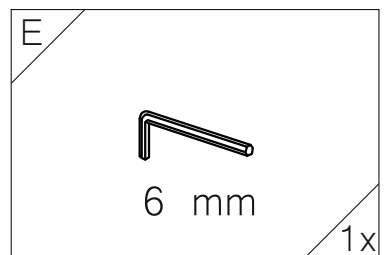
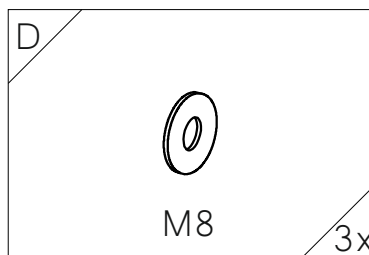
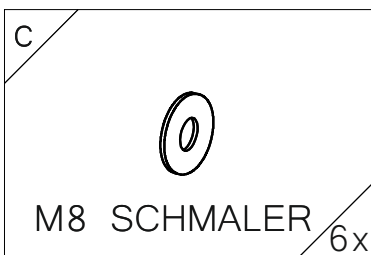
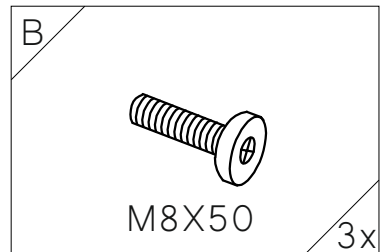
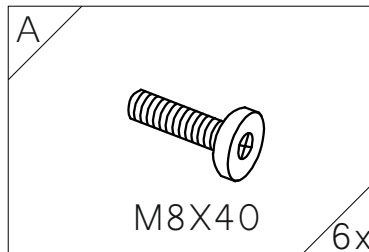
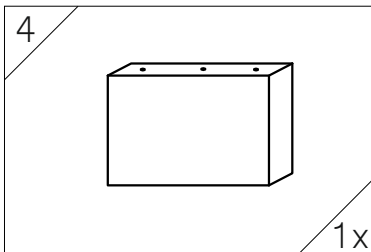
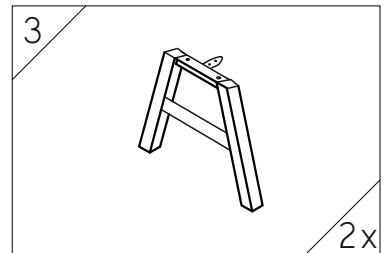
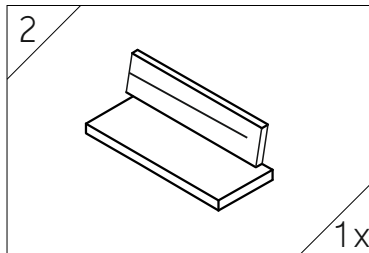
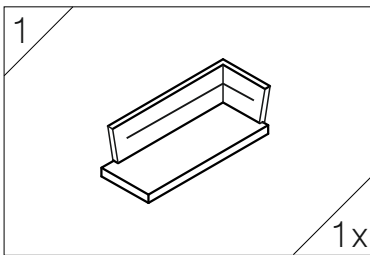
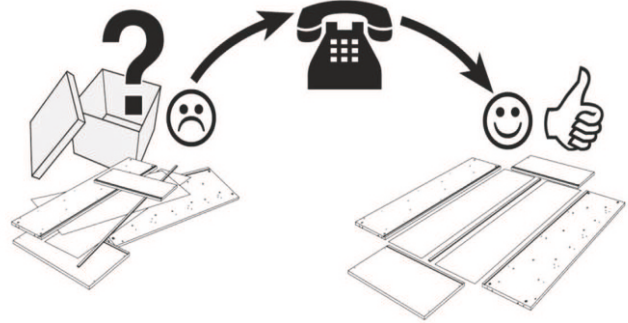
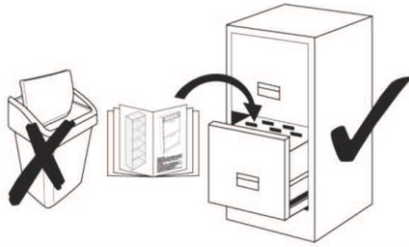

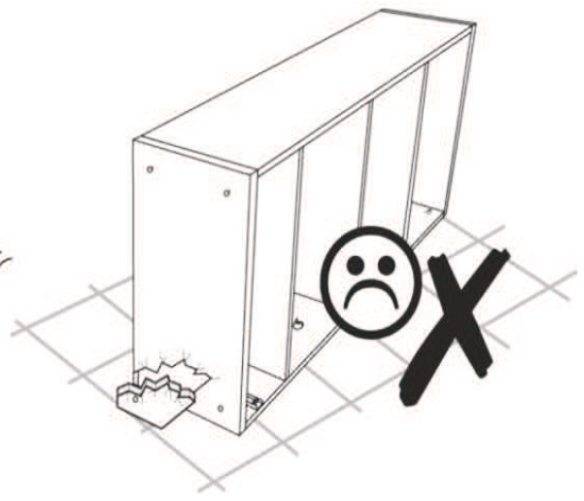
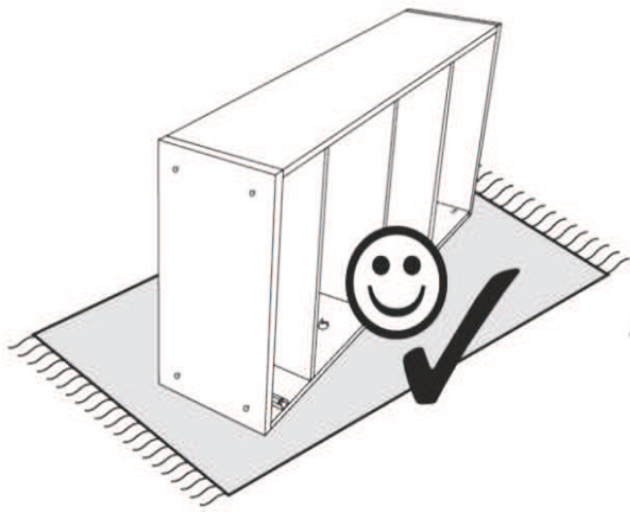

**1**

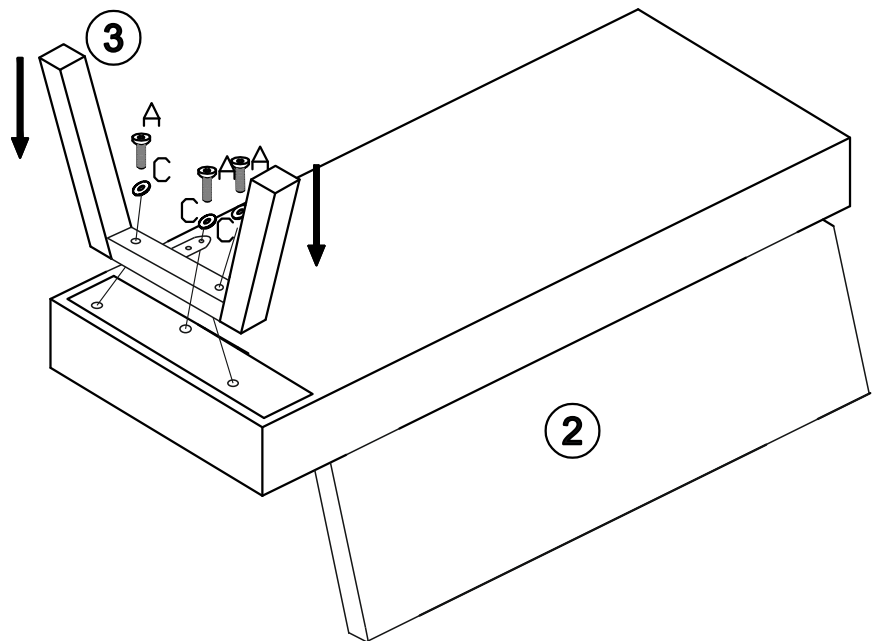
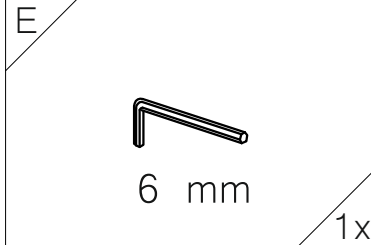
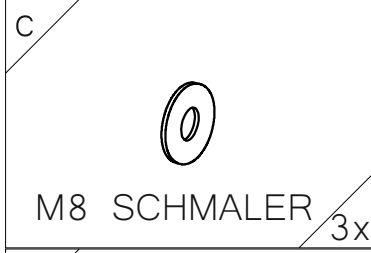
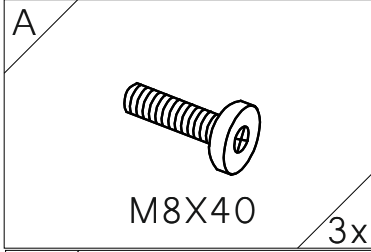
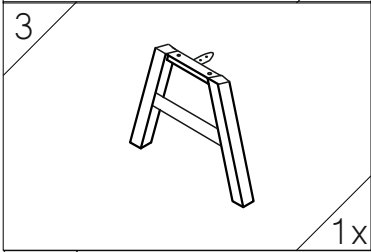
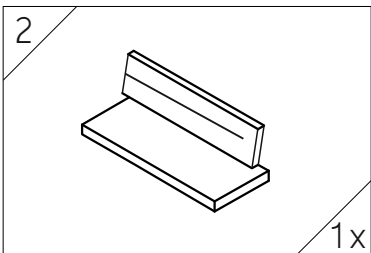

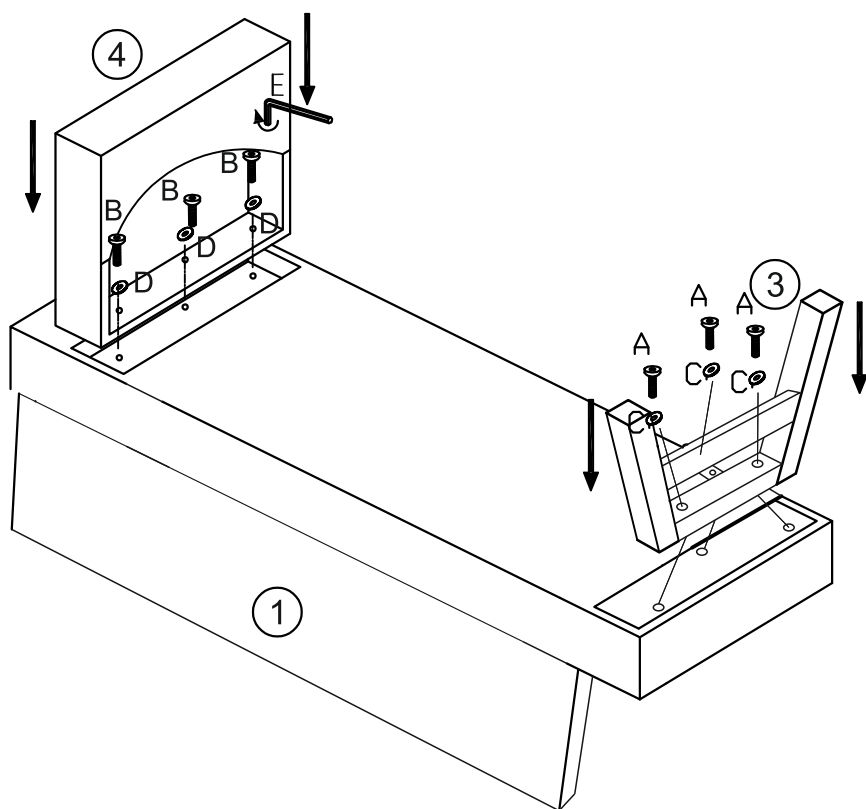
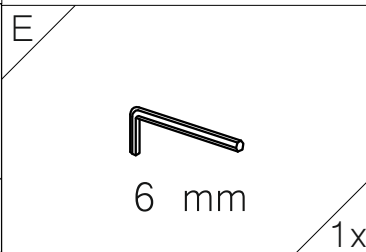
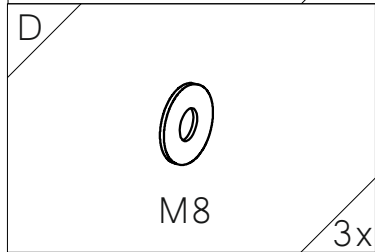
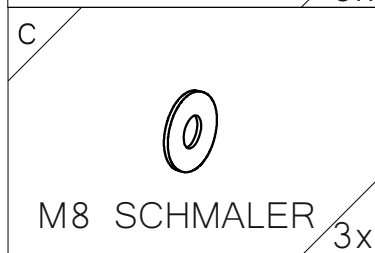
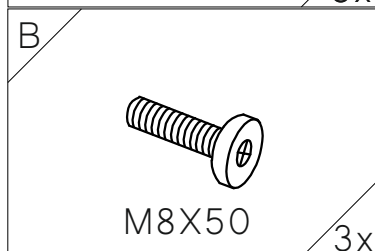
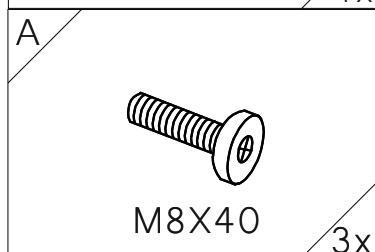
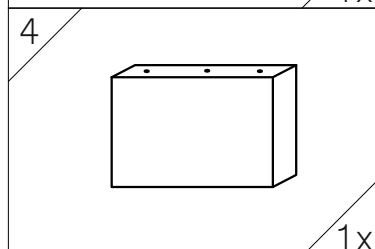
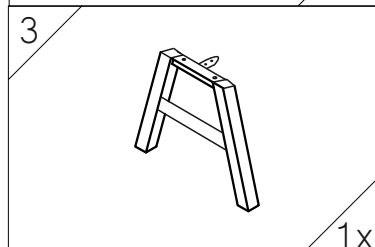
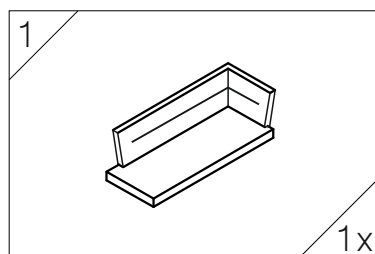

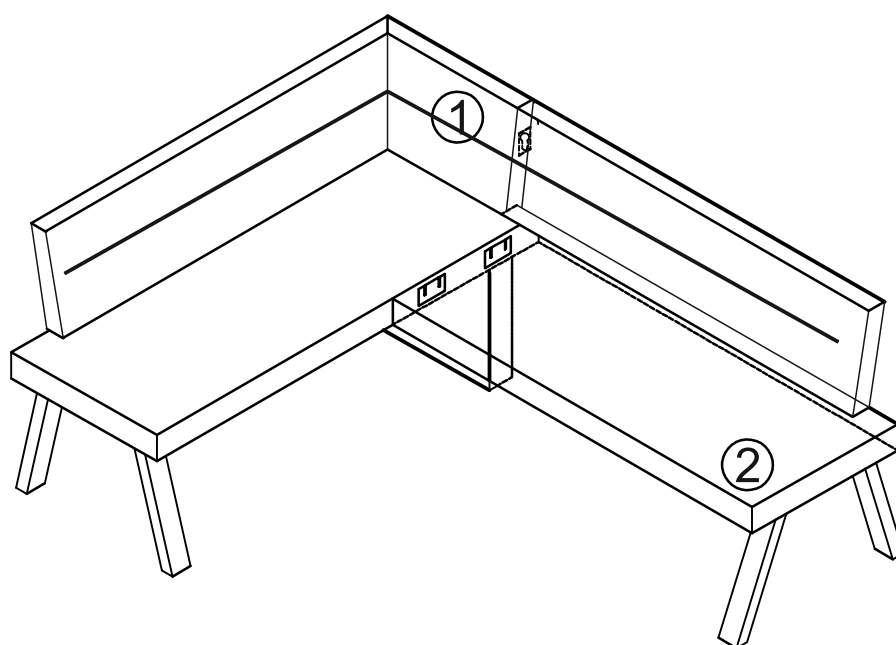
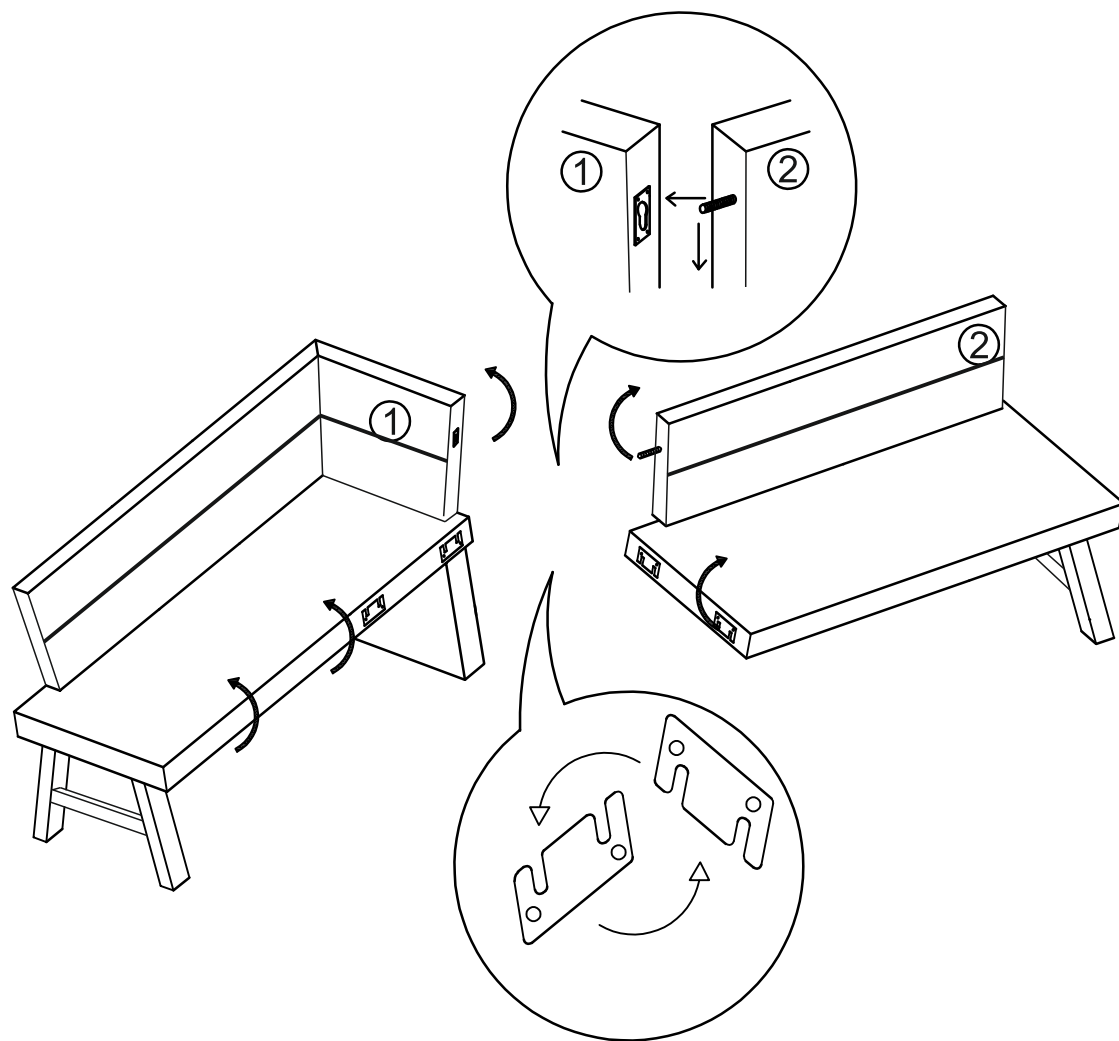



- D Allgemeiner Sicherheitshinweis:**  
Nicht mehr benötigte Verpackungs-Materialien und Kleinteile von Kindern fernhalten!
- GB General safety instructions:**  
Package material you do not need any more take far away from children.
- F Consigne de sécurité:**  
Ecartez les matériaux d'emballage et petites pièces inutiles de la portée des enfants.
- PL Ogólne zasady bezpieczeñstwa:**  
Nie potrzebne opakowania i małe części chronić przed dziećmi!
- RU Общие указания по безопасности:**  
Неиспользуемые упаковочные материалы и мелкие детали следует хранить в недоступном для детей месте!
- NL Algemene veiligheidsinstructie:**  
Verpakkingsmaterialen die u niet meer nodig heeft en kleine onderdelen uit de buurt van kinderen houden!
- TR Genel güvenlik uyarısı:**  
Kullanılmayan ambalaj malzemeleri ve küçük parçaları çocuklardan uzak tutun!
- RO Indicație generală de siguranță:**  
Ambalajele care nu mai sunt necesare și piesele de mici dimensiuni nu vor fi lăsate la îndemâna copiilor!
- IT Indicazioni generali per la sicurezza:**  
Tenere lontano da bambini materiali di imballaggio non più necessari e minuterie!
- SK Všeobecné bezpečnostné upozornenie:**  
Nepotrebný baliaci materiál a malé diely uchovávajte mimo dosahu detí!
- CZ Všeobecné bezpečnostní upozornění:**  
Obalové materiály a malé díly, které už nepotřebujete, udržujte mimo dosah dětí!
- HU Általános biztonsági tudnivaló:**  
Ha már nincs szüksége a csomagolóanyagokra és apró darabokra, tegye őket olyan helyre, ahol nem férhetnek hozzá gyermekek!