

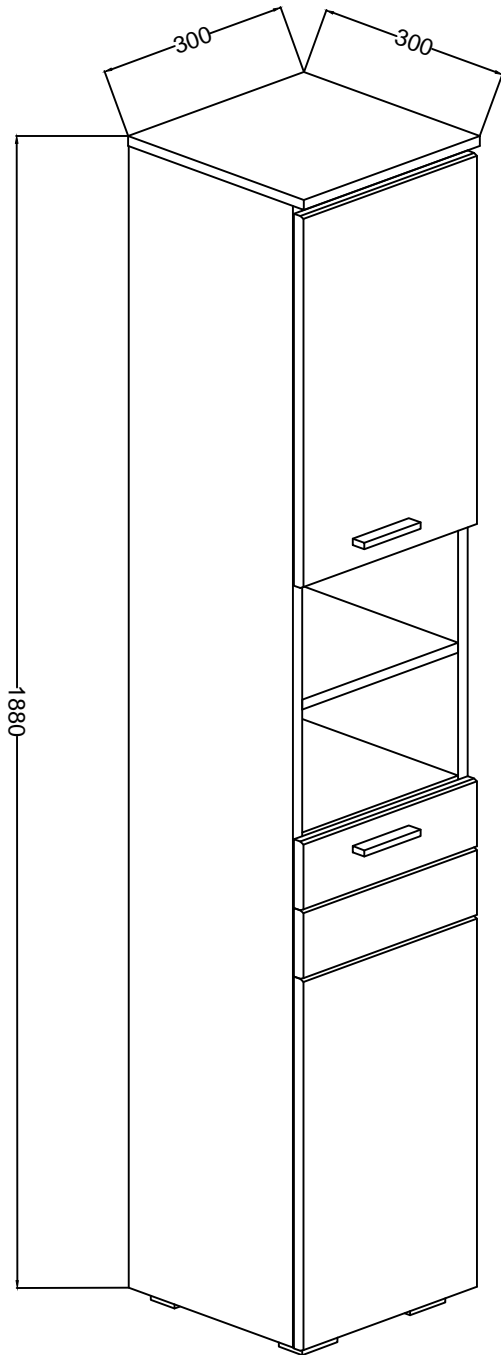

















70-509-V2



 HG 5	 L 8	 P 10	 A 20
 C 16	 D2 16	 F1 4	 J3 8
 J7 10	 R 8	 S 2	 R1 4
 O3 1	 O2 1	 O1 1	 E 16
 O4 2	 E5 3		

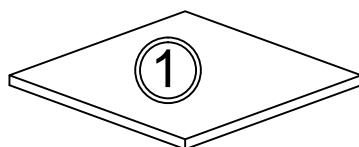

6

7



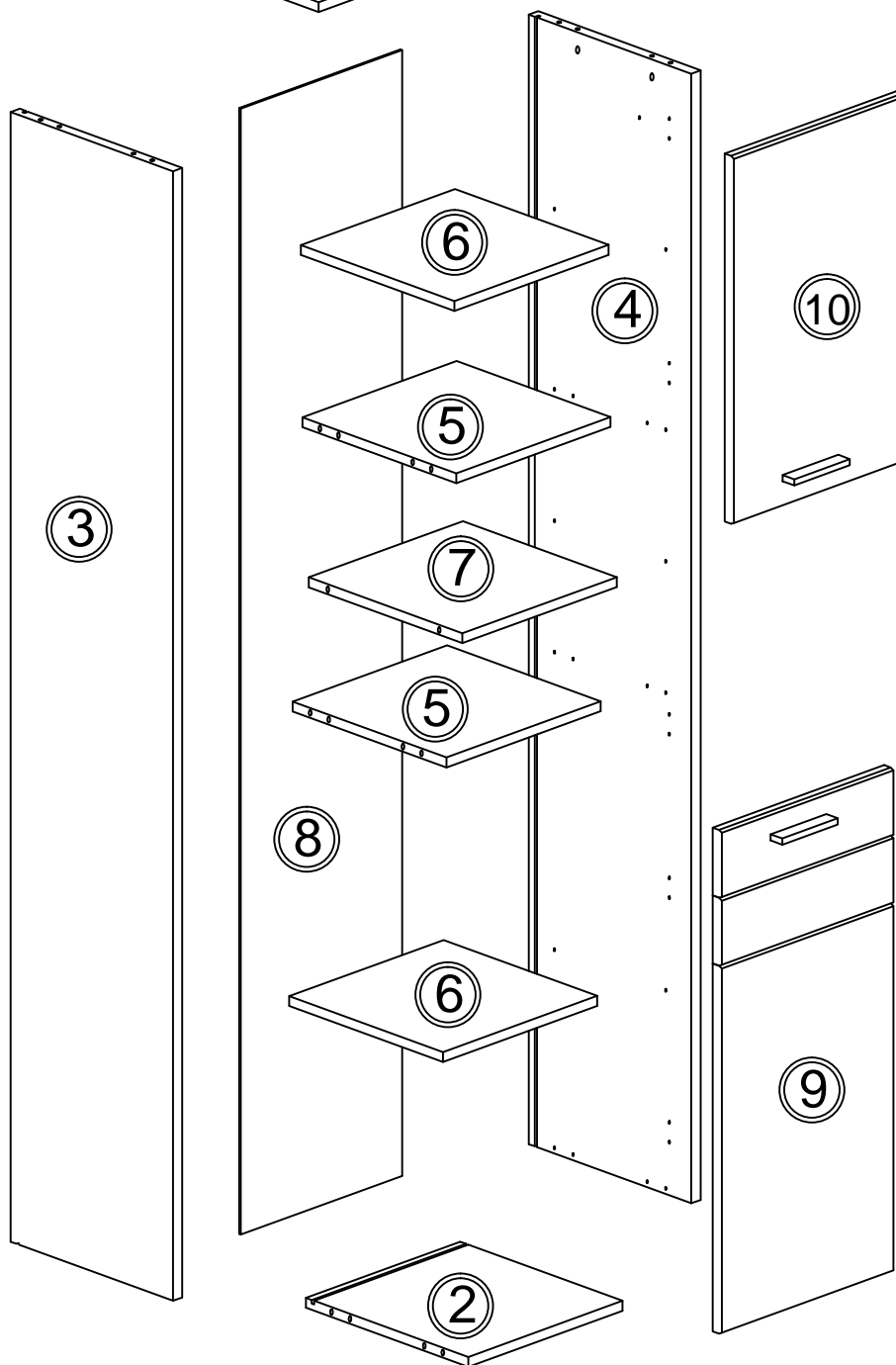

5

2



PACK 1 / 1		
No.	Dimmension	Qty.
1	300x300x16	1
2	280x266x16	1
3	1830x280x16	1
4	1830x280x16	1
5	265x266x16	2
6	265x266x16	2
7	265x266x16	1
8	1824x276x3	1
9	816x296x16	1
10	596x296x16	1

1

 D2 12	 A 4	 C 4
---	---	---

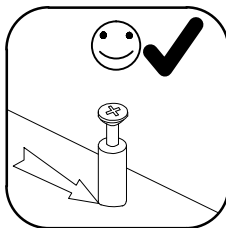
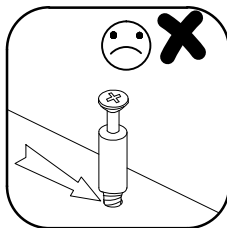
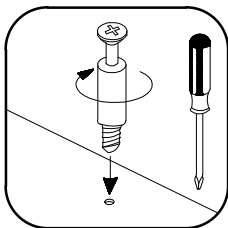
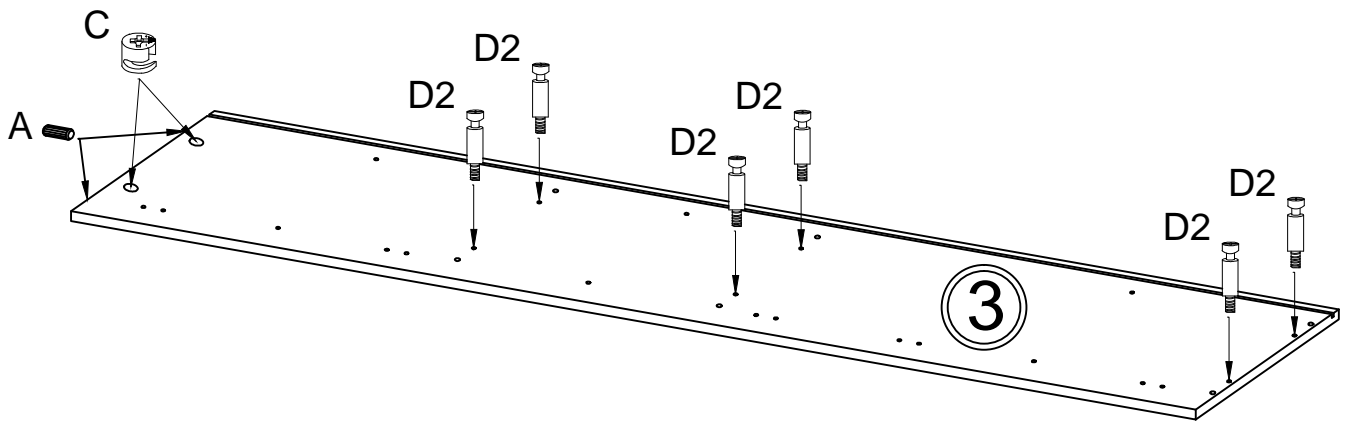
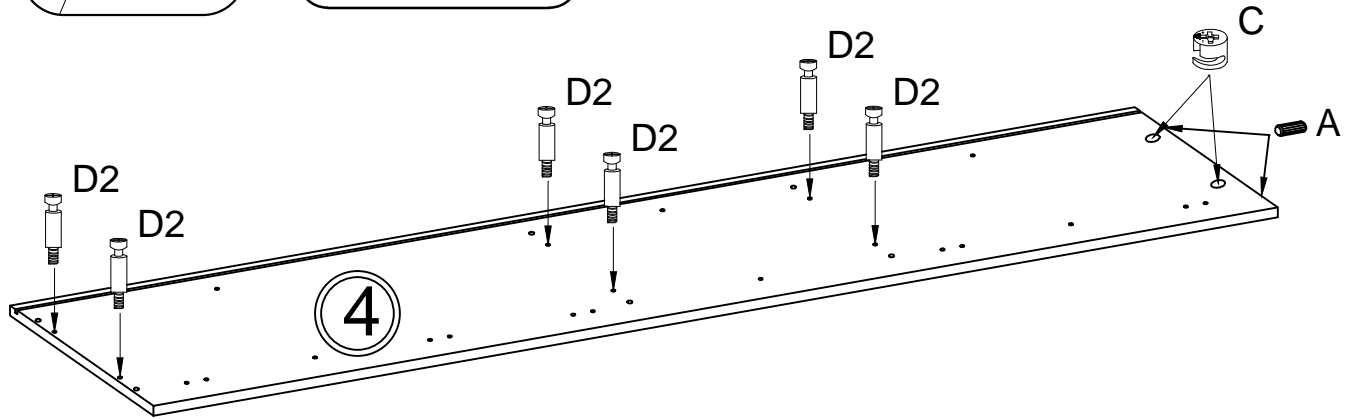
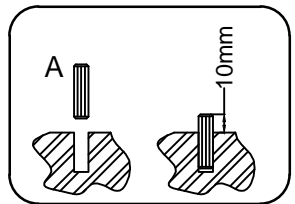
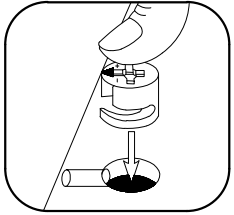
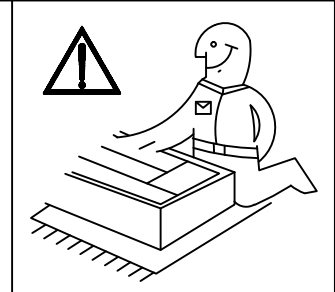

2

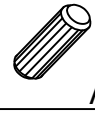
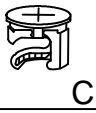
 D2 4	 A 16	 C 12
--	--	--

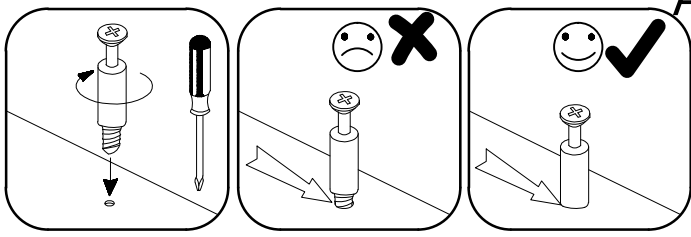
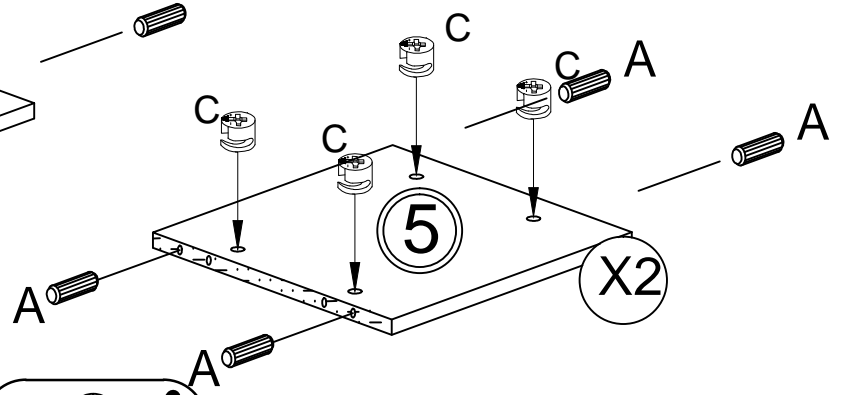
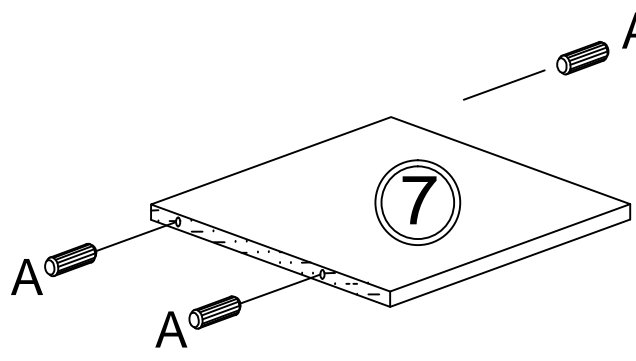
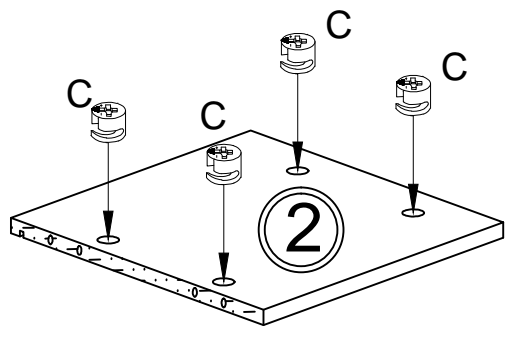
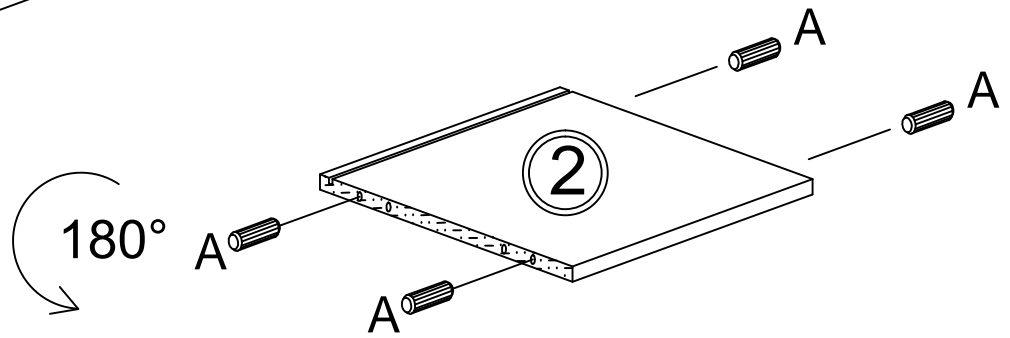
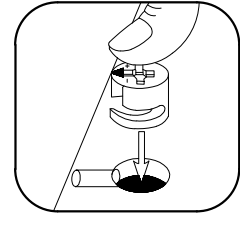
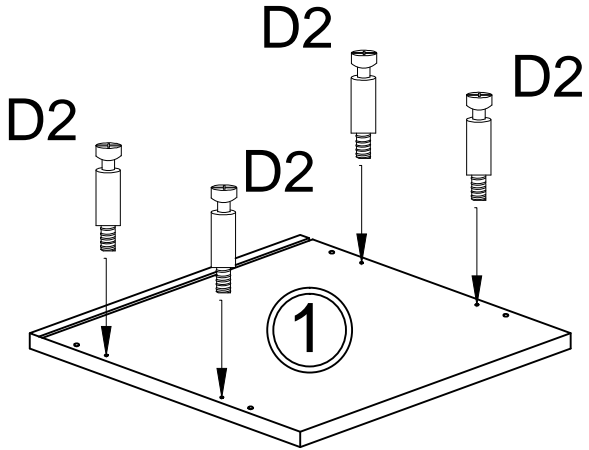
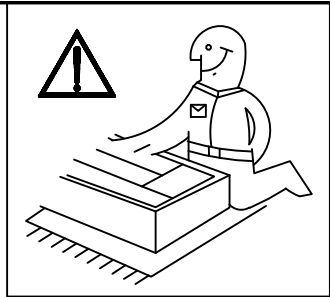

4

3

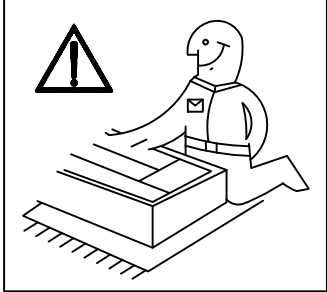

4

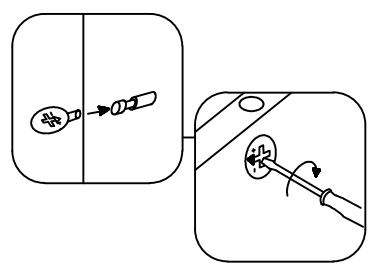
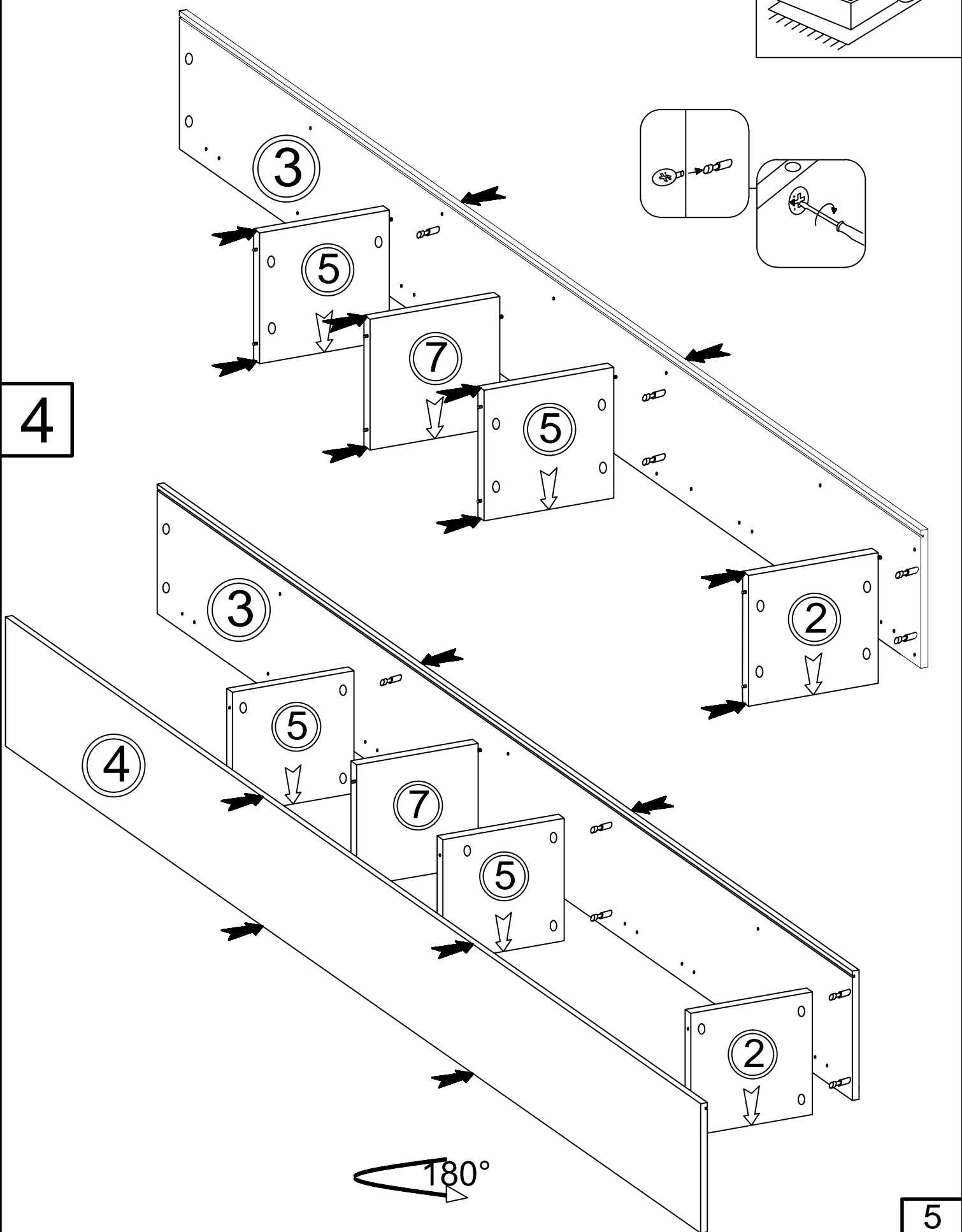

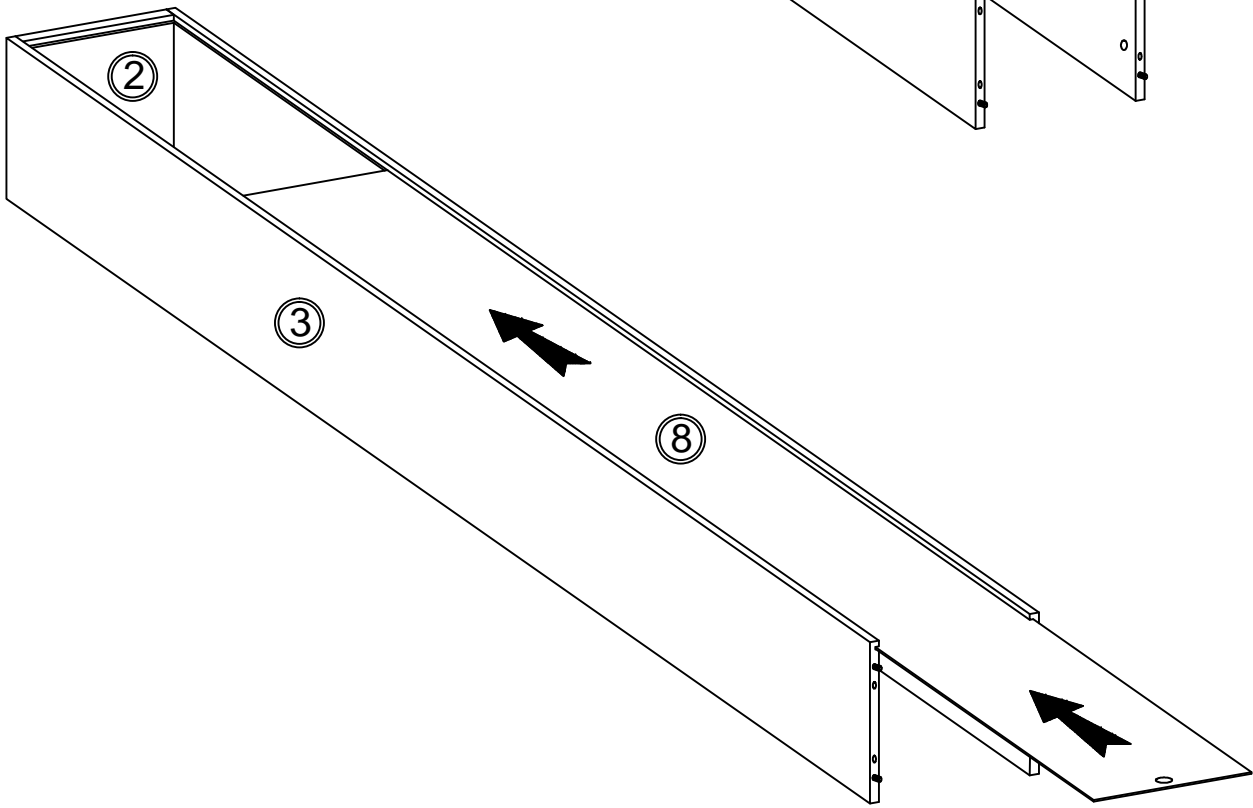
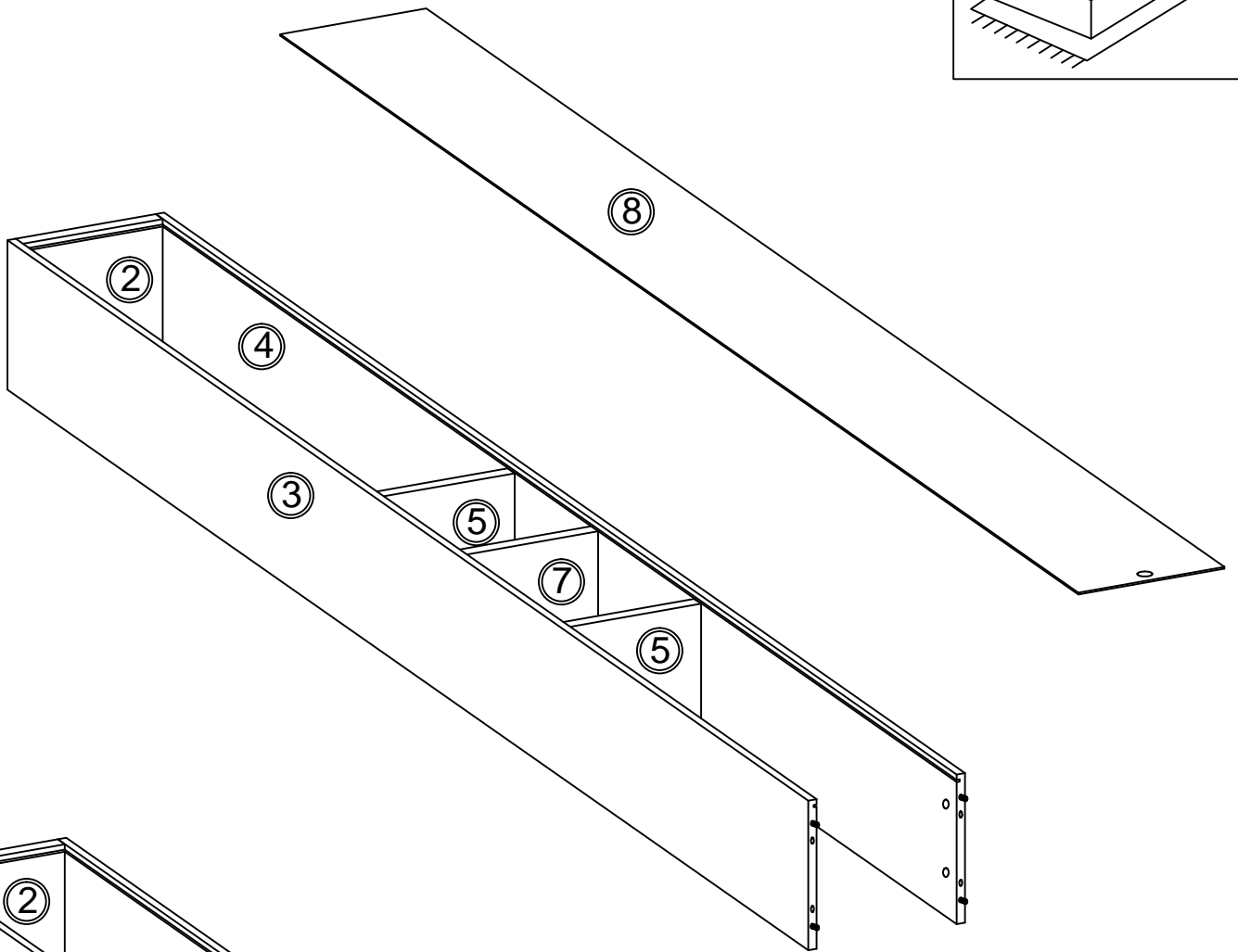
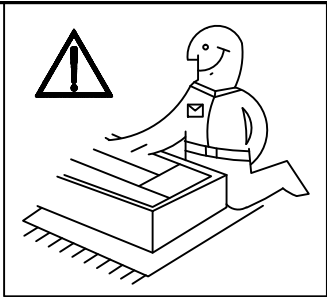

5

5

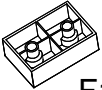

6

6



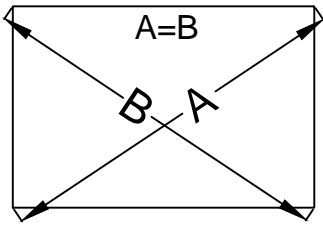
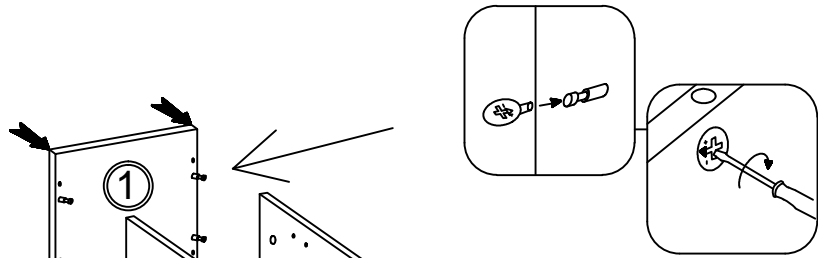
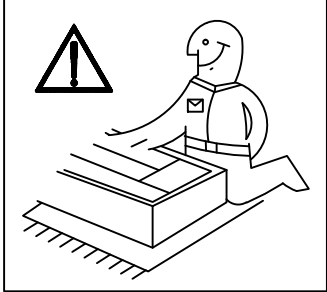

60x60x25  F1 4	Ø4.0x30mm  R 8	 L 8
--	--	---

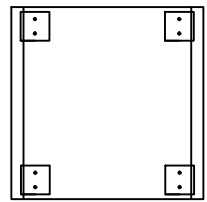
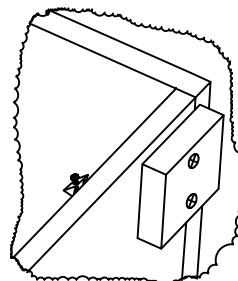
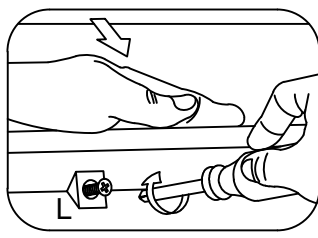
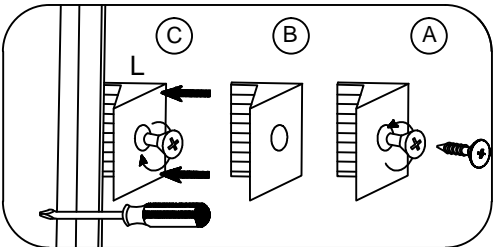
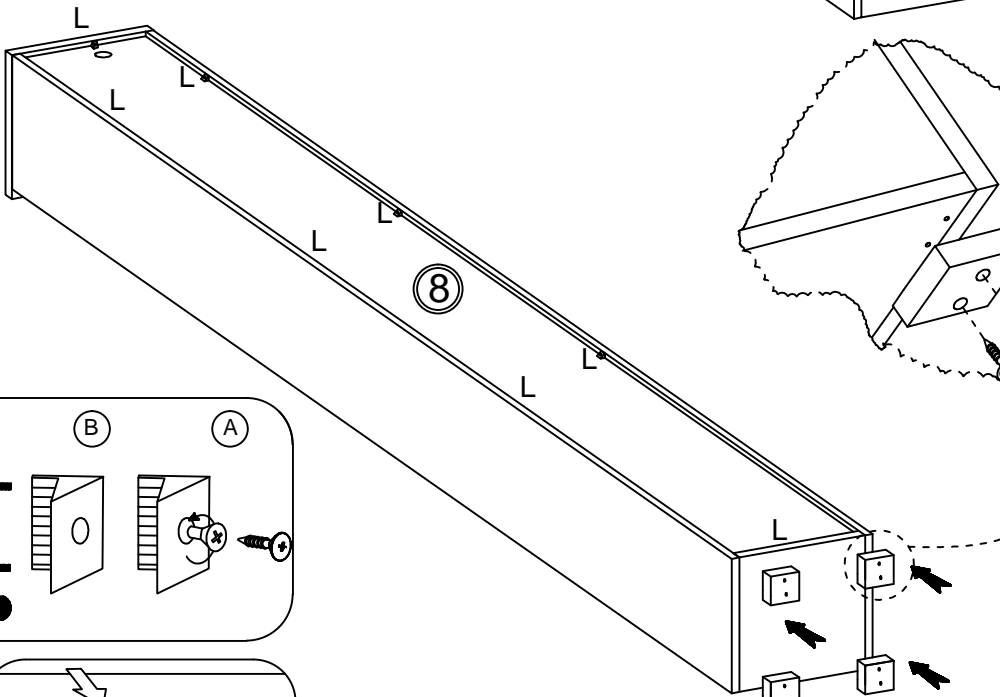

180°



7

 Ø4.0x18mm O3	 O2	 75x30x15mm O1	 O4
1	1	1	2

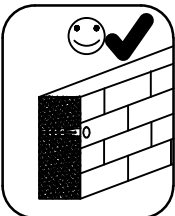
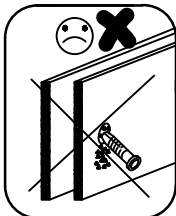
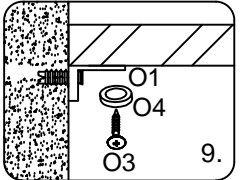
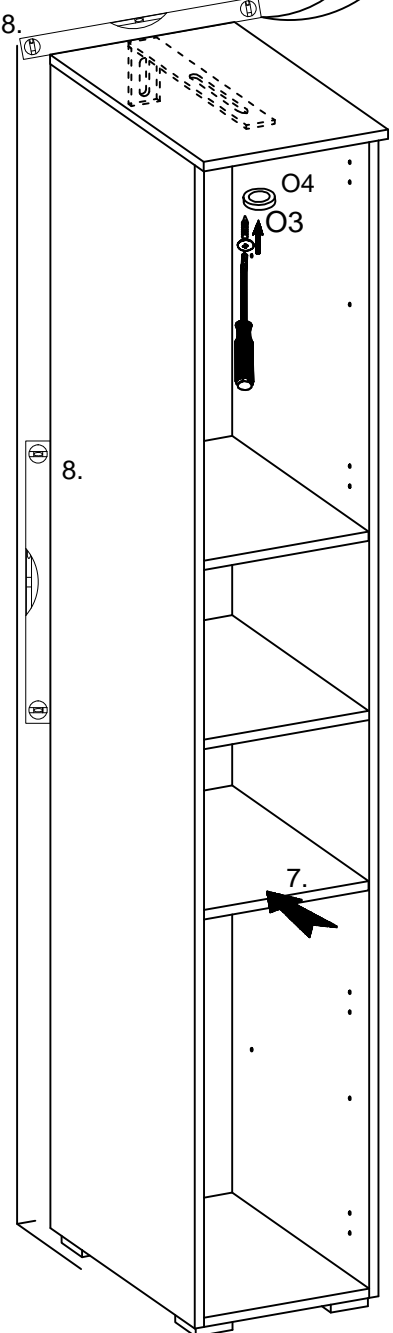
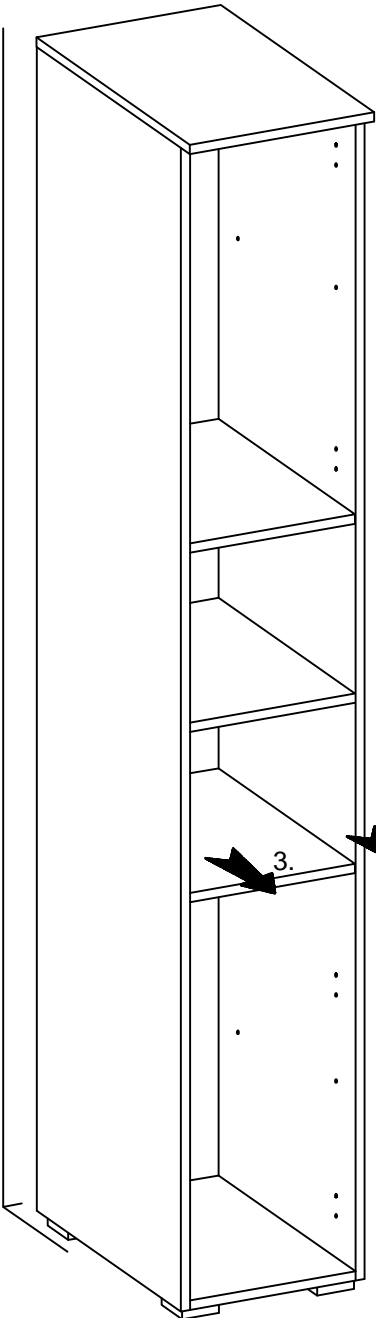
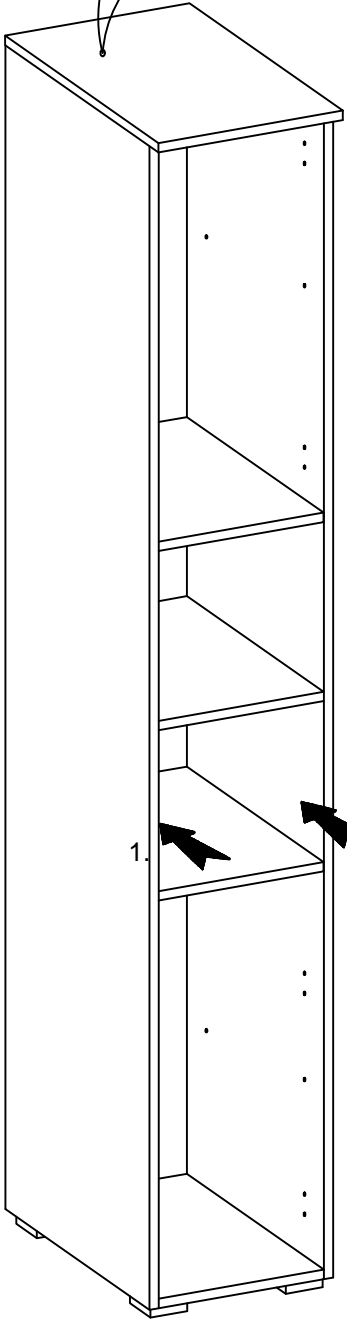
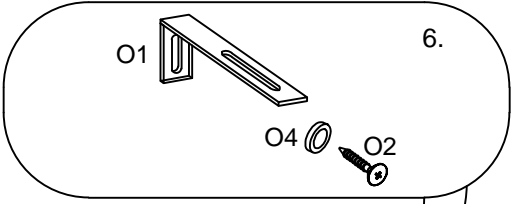
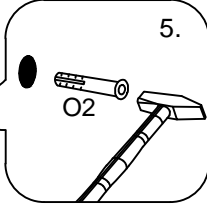
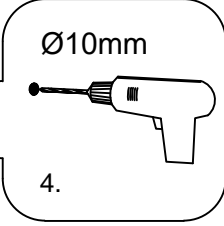
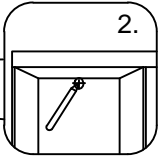

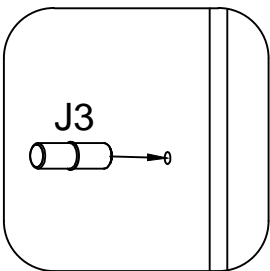
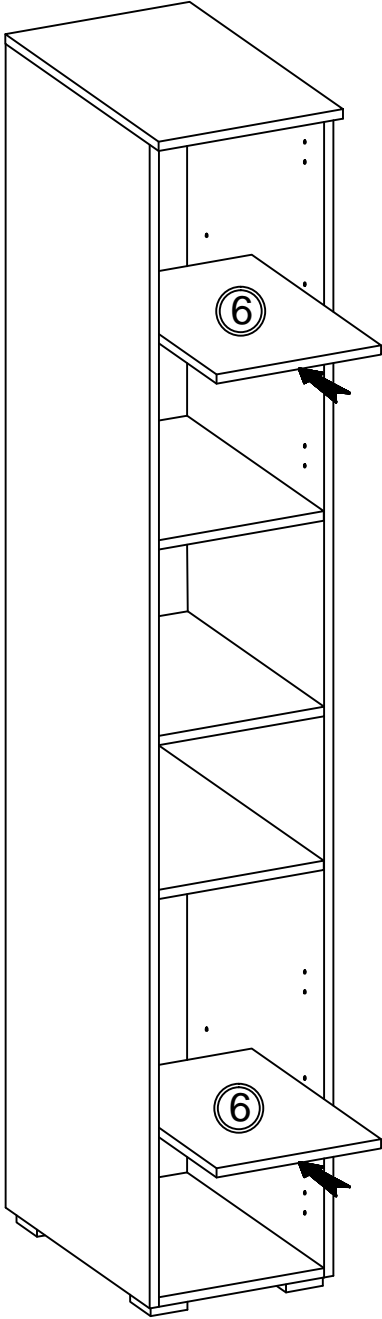
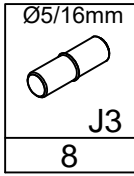

8



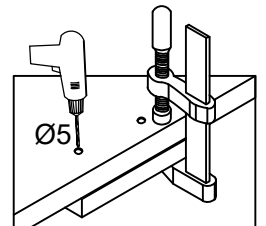
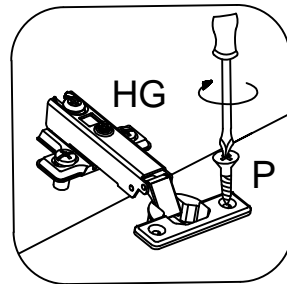
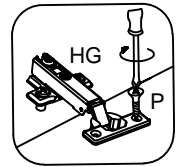
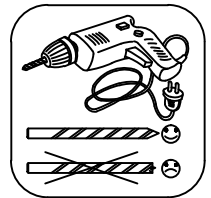
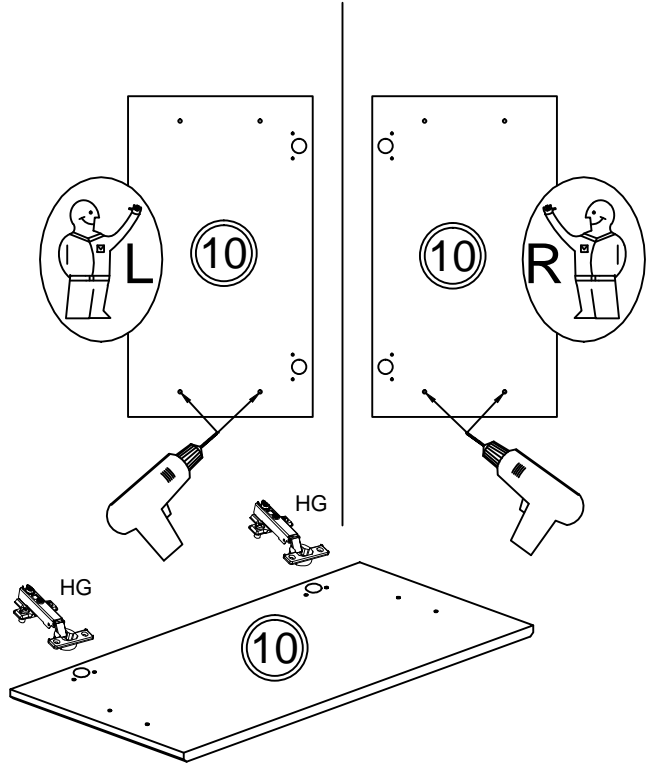
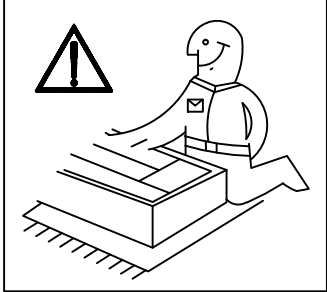
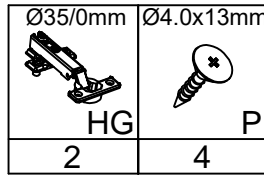



9

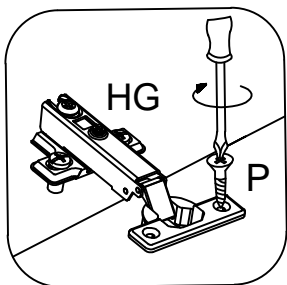
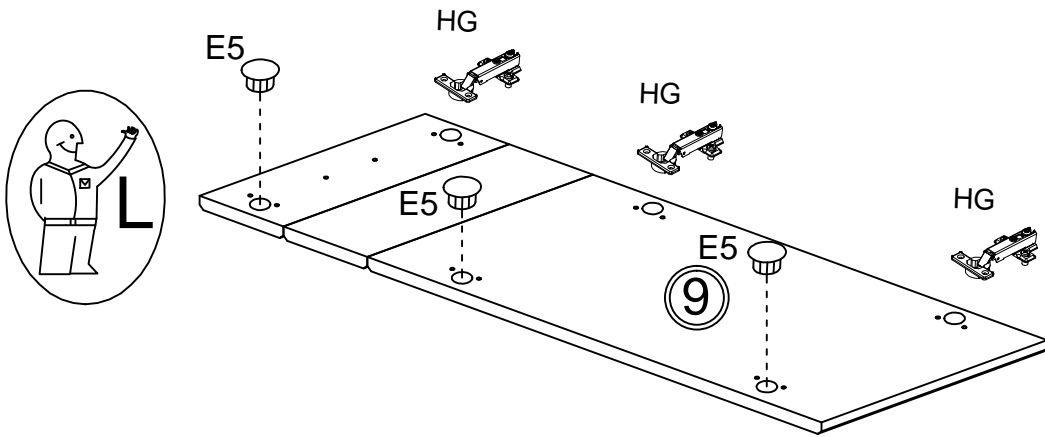
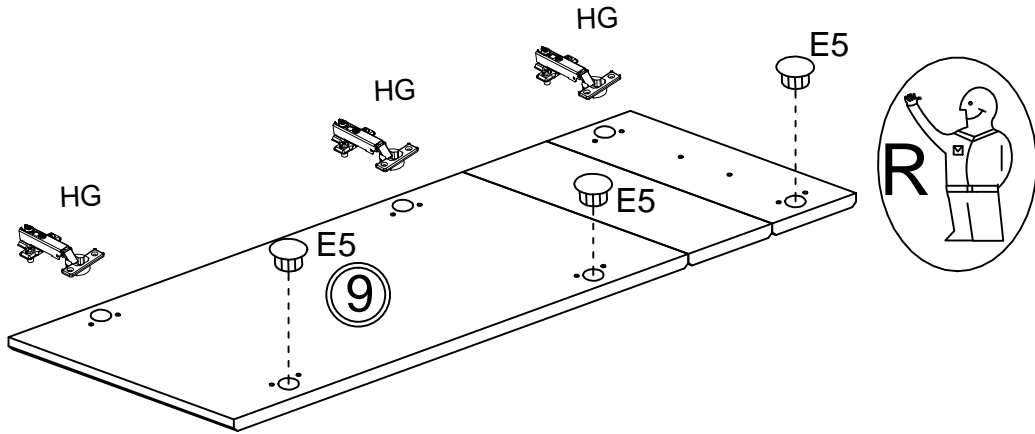
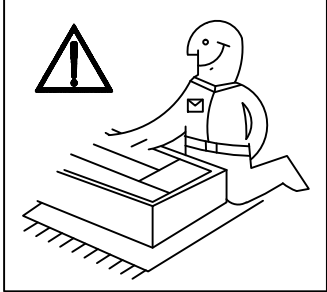

9

$\varnothing 35/0\text{mm}$  HG	$\varnothing 4.0 \times 13\text{mm}$  P	$\varnothing 35\text{mm}$  E5
3	6	3



L=96mm  S 2	Ø3.5x25mm  R1 4	Ø5/4mm  J7 10	 E 12
---	---	---	--

