

2

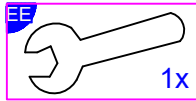

1

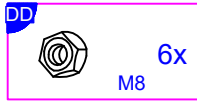
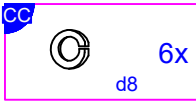
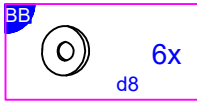
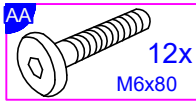
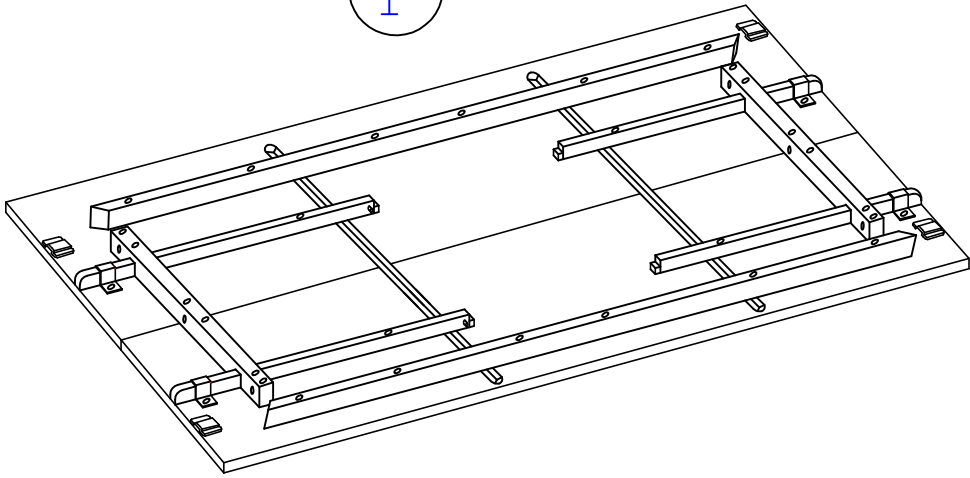

2 x 2

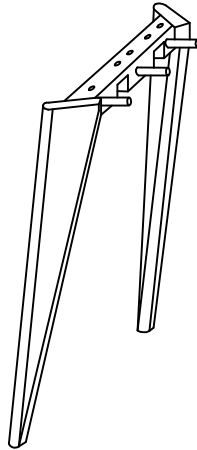

3

