



Kühl- und Gefrierkombination  
Réfrigérateur / Congélateur  
combiné  
Combinazione frigorifero / con-  
gelatore  
Koelvriescombinatie

[de] Gebrauchsanleitung  
[fr] Manuel d'utilisation  
[it] Manuale utente  
[nl] Gebruikershandleiding

**KI242....., KI232....., KI222.....,**



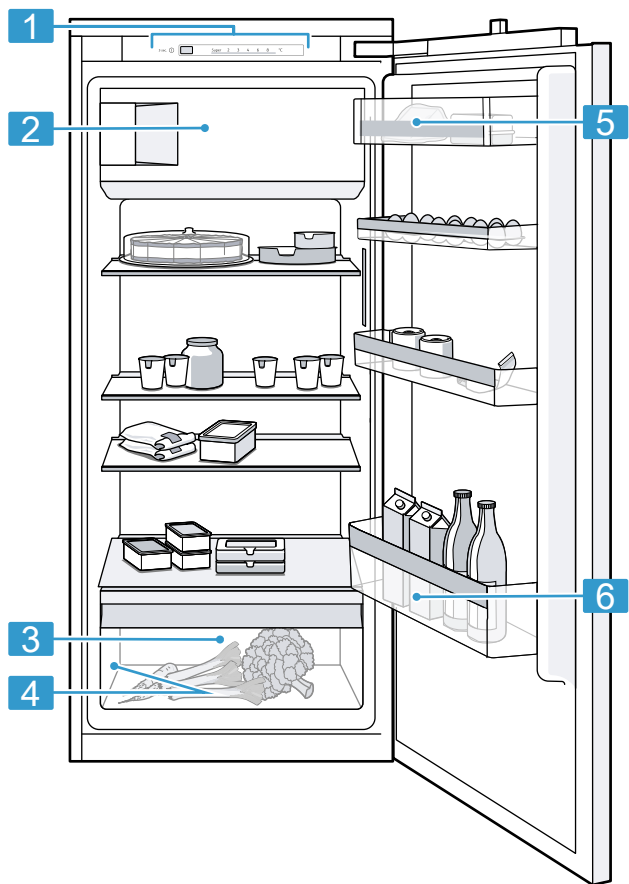

**1**

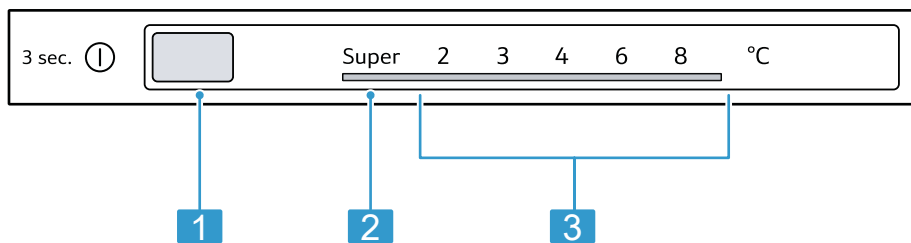

**2**

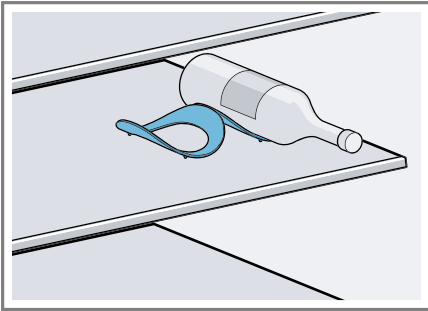

3



4

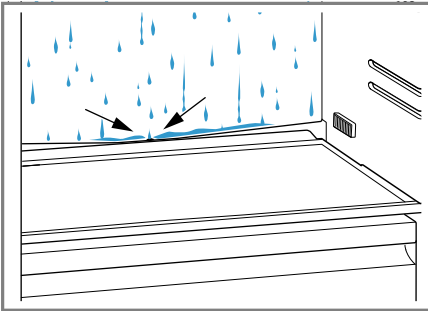

5

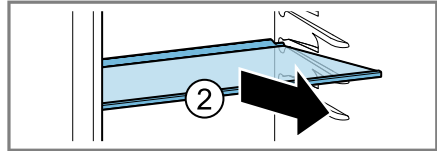
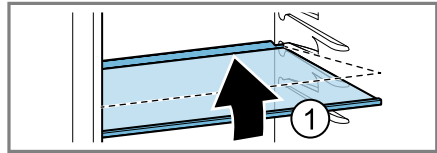

6

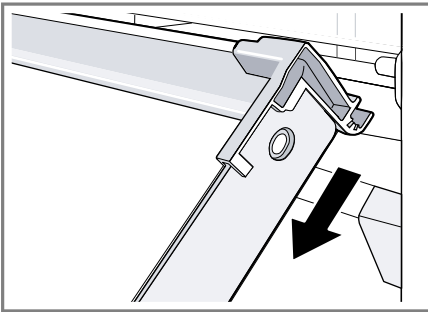

7

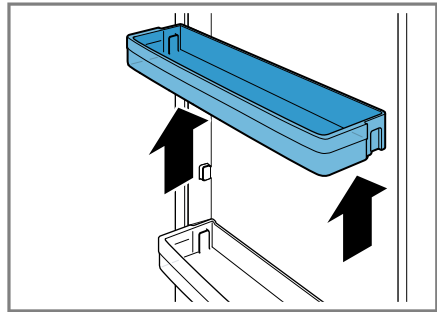

8

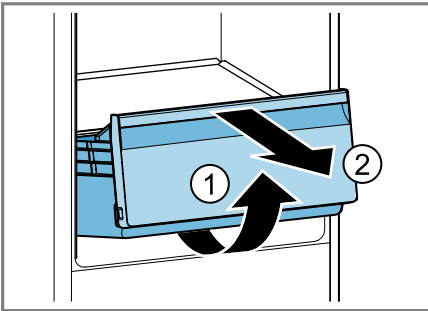

9

# Inhaltsverzeichnis

<b>1 Sicherheit .....</b>	<b>6</b>	<b>8 Zusatzfunktionen .....</b>	<b>16</b>
1.1 Allgemeine Hinweise .....	6	8.1 Super-Funktion .....	16
1.2 Bestimmungsgemäßer Gebrauch .....	6	<b>9 Kühlfach .....</b>	<b>16</b>
1.3 Einschränkung des Nutzerkreises .....	6	9.1 Tipps zum Einlagern von Lebensmitteln ins Kühlfach .....	16
1.4 Sicherer Transport.....	7	9.2 Kältezonen im Kühlfach .....	16
1.5 Sichere Installation .....	7	9.3 Aufkleber OK.....	17
1.6 Sicherer Gebrauch .....	8	<b>10 Gefrierfach.....</b>	<b>17</b>
1.7 Beschädigtes Gerät.....	10	10.1 Gefrierfachtür.....	17
<b>2 Sachschäden vermeiden .....</b>	<b>12</b>	10.2 Gefriervermögen .....	17
<b>3 Umweltschutz und Sparen .....</b>	<b>12</b>	10.3 Tipps zum Einlagern von Lebensmitteln ins Gefrierfach.....	17
3.1 Verpackung entsorgen.....	12	10.4 Tipps zum Einfrieren frischer Lebensmittel .....	18
3.2 Energie sparen .....	12	10.5 Haltbarkeit des Gefrierguts bei -18 °C.....	18
<b>4 Aufstellen und Anschließen .....</b>	<b>12</b>	10.6 Auftaumethoden für Gefriergut .....	18
4.1 Lieferumfang.....	12	<b>11 Abtauen .....</b>	<b>19</b>
4.2 Kriterien für den Aufstellort.....	13	11.1 Abtauen im Kühlfach.....	19
4.3 Gerät montieren .....	13	11.2 Abtauen im Gefrierfach .....	19
4.4 Gerät für den ersten Gebrauch vorbereiten .....	13	<b>12 Reinigen und Pflegen .....</b>	<b>19</b>
4.5 Gerät elektrisch anschließen....	14	12.1 Gerät zum Reinigen vorbereiten.....	19
<b>5 Kennenlernen .....</b>	<b>14</b>	12.2 Gerät reinigen.....	20
5.1 Gerät.....	14	12.3 Tauwasserrinne und Ablaufloch reinigen.....	20
5.2 Bedienfeld .....	14	12.4 Ausstattungsteile entnehmen .....	20
<b>6 Ausstattung.....</b>	<b>14</b>	<b>13 Störungen beheben .....</b>	<b>22</b>
6.1 Ablage .....	14	13.1 Stromausfall.....	24
6.2 Gefrierfachklappe .....	14	13.2 Geräteselbsttest durchführen .....	24
6.3 Obst- und Gemüsebehälter .....	14	<b>14 Lagern und Entsorgen.....</b>	<b>24</b>
6.4 Butter- und Käsefach.....	15	14.1 Gerät außer Betrieb nehmen .....	24
6.5 Türabsteller.....	15	14.2 Altgerät entsorgen.....	25
6.6 Zubehör .....	15		
<b>7 Grundlegende Bedienung .....</b>	<b>15</b>		
7.1 Gerät einschalten .....	15		
7.2 Hinweise zum Betrieb.....	15		
7.3 Gerät ausschalten .....	15		
7.4 Temperatur einstellen.....	15		

**15 Kundendienst ..... 25**  
15.1 Erzeugnisnummer (E-Nr.)  
und Fertigungsnummer  
(FD) ..... 26

**16 Technische Daten ..... 26**



# 1 Sicherheit

---

Beachten Sie die nachfolgenden Sicherheitshinweise.

## 1.1 Allgemeine Hinweise

- Lesen Sie diese Anleitung sorgfältig.
- Bewahren Sie die Anleitung sowie die Produktinformationen für einen späteren Gebrauch oder Nachbesitzer auf.
- Schließen Sie das Gerät bei einem Transportschaden nicht an.

## 1.2 Bestimmungsgemäßer Gebrauch

Dieses Gerät ist nur für den Einbau bestimmt.

Verwenden Sie das Gerät nur:

- um Lebensmittel zu kühlen und zu gefrieren und zur Eiskübelbereitung.
- im privaten Haushalt und in geschlossenen Räumen des häuslichen Umfelds.
- bis zu einer Höhe von 2000 m über dem Meeresspiegel.

## 1.3 Einschränkung des Nutzerkreises

Dieses Gerät kann von Kindern ab 8 Jahren und darüber und von Personen mit reduzierten physischen, sensorischen oder mentalen Fähigkeiten oder Mangel an Erfahrung und/oder Wissen benutzt werden, wenn sie beaufsichtigt oder bezüglich des sicheren Gebrauchs des Geräts unterwiesen wurden und die daraus resultierenden Gefahren verstanden haben.

Kinder dürfen nicht mit dem Gerät spielen.

Reinigung und Benutzerwartung dürfen nicht durch Kinder ohne Beaufsichtigung durchgeführt werden.

Kinder ab 3 Jahren und jünger als 8 Jahre dürfen das Kühl-/Gefriergerät be- und entladen.

## 1.4 Sicherer Transport

### **⚠️ WARNUNG – Verletzungsgefahr!**

Das hohe Gerätegewicht kann beim Anheben zu Verletzungen führen.

- ▶ Das Gerät nicht alleine anheben.

## 1.5 Sichere Installation

### **⚠️ WARNUNG – Stromschlaggefahr!**

Unsachgemäße Installationen sind gefährlich.

- ▶ Das Gerät nur gemäß den Angaben auf dem Typenschild anschließen und betreiben.
- ▶ Das Gerät nur über eine vorschriftsmäßig installierte Steckdose mit Erdung an ein Stromnetz mit Wechselstrom anschließen.
- ▶ Das Schutzleitersystem der elektrischen Hausinstallation muss vorschriftsmäßig installiert sein.
- ▶ Nie das Gerät über eine externe Schaltvorrichtung versorgen, z. B. Zeitschaltuhr oder Fernsteuerung.
- ▶ Wenn das Gerät eingebaut ist, muss der Netzstecker der Netzanschlussleitung frei zugänglich sein, oder falls der freie Zugang nicht möglich ist, muss in der festverlegten elektrischen Installation eine allpolige Trennvorrichtung nach den Errichtungsbestimmungen eingebaut werden.
- ▶ Beim Aufstellen des Geräts darauf achten, dass die Netzanschlussleitung nicht eingeklemmt oder beschädigt wird.

Eine beschädigte Isolierung der Netzanschlussleitung ist gefährlich.

- ▶ Nie die Netzanschlussleitung mit Wärmequellen in Kontakt bringen.

### **⚠️ WARNUNG – Explosionsgefahr!**

Wenn die Belüftungsöffnungen des Geräts verschlossen sind, kann bei einem Leck des Kältekreislaufs ein brennbares Gas-Luft-Gemisch entstehen.

- ▶ Belüftungsöffnungen im Gerätegehäuse oder im Einbaugehäuse nicht verschließen.

### **⚠️ WARNUNG – Brandgefahr!**

Eine verlängerte Netzanschlussleitung und nicht zugelassene Adapter zu verwenden, ist gefährlich.

- ▶ Keine Verlängerungskabel oder Mehrfachsteckdosenleisten verwenden.
  - ▶ Wenn die Netzanschlussleitung zu kurz ist, den Kundendienst kontaktieren.
  - ▶ Nur vom Hersteller zugelassene Adapter verwenden.
- Ortsveränderliche Mehrfachsteckdosenleisten oder Netzteile können überhitzen und zum Brand führen.
- ▶ Ortsveränderliche Mehrfachsteckdosenleisten oder Netzteile nicht an der Rückseite der Geräte platzieren.

## **1.6 Sicherer Gebrauch**

### **⚠️ WARNUNG – Stromschlaggefahr!**

Eindringende Feuchtigkeit kann einen Stromschlag verursachen.

- ▶ Das Gerät nur in geschlossenen Räumen verwenden.
- ▶ Nie das Gerät großer Hitze und Nässe aussetzen.
- ▶ Keinen Dampfreiniger oder Hochdruckreiniger verwenden, um das Gerät zu reinigen.

### **⚠️ WARNUNG – Erstickungsgefahr!**

Kinder können sich Verpackungsmaterial über den Kopf ziehen oder sich darin einwickeln und ersticken.

- ▶ Verpackungsmaterial von Kindern fernhalten.
- ▶ Kinder nicht mit Verpackungsmaterial spielen lassen.

Kinder können Kleinteile einatmen oder verschlucken und dadurch ersticken.

- ▶ Kleinteile von Kindern fernhalten.
- ▶ Kinder nicht mit Kleinteilen spielen lassen.

### **⚠️ WARNUNG – Explosionsgefahr!**

Durch Beschädigung des Kältekreislaufs kann brennbares Kältemittel austreten und explodieren.

- ▶ Zum Beschleunigen des Abtauvorgangs keine anderen mechanischen Einrichtungen oder sonstigen Mittel als die vom Hersteller empfohlenen benutzen.



- ▶ Festgefrorene Lebensmittel mit einem stumpfen Gegenstand lösen, z. B. Holzlöffelstiel.

Produkte mit brennbaren Treibgasen und explosiven Stoffen können explodieren, z. B. Spraydosen.

- ▶ Keine Produkte mit brennbaren Treibgasen und explosiven Stoffen im Gerät lagern.

### **⚠ WARNUNG – Brandgefahr!**

Elektrische Geräte innerhalb des Geräts können zu einem Brand führen, z. B. Heizgeräte oder elektrische Eisbereiter.

- ▶ Keine elektrischen Geräte innerhalb des Geräts betreiben.

### **⚠ WARNUNG – Verletzungsgefahr!**

Behälter mit kohlenensäurehaltigen Getränken können platzen.

- ▶ Keine Behälter mit kohlenensäurehaltigen Getränken im Gefrierfach lagern.

Verletzung der Augen durch Austritt von brennbarem Kältemittel und schädlichen Gasen.

- ▶ Nicht die Rohre des Kältemittel-Kreislaufs und die Isolierung beschädigen.

### **⚠ WARNUNG – Verbrennungsgefahr durch Kälte!**

Kontakt mit Gefriergut und kalten Oberflächen kann zu Verbrennungen durch Kälte führen.

- ▶ Nie Gefriergut sofort in den Mund nehmen, nachdem es aus dem Gefrierfach genommen wurde.
- ▶ Längeren Kontakt der Haut mit Gefriergut, Eis und Oberflächen im Gefrierfach vermeiden.

### **⚠ VORSICHT – Gefahr von Gesundheitsschäden!**

Um die Verunreinigung von Lebensmitteln zu vermeiden, sind die folgenden Anweisungen zu beachten.

- ▶ Wenn die Tür für eine längere Zeit geöffnet wird, kann es zu einem erheblichen Temperaturanstieg in den Fächern des Gerätes kommen.
- ▶ Die Flächen, die mit Lebensmitteln und zugänglichen Ablaufsystemen in Berührung kommen können, regelmäßig reinigen.

- ▶ Rohes Fleisch und Fisch in geeigneten Behältern im Kühlschrank so aufbewahren, dass es andere Lebensmittel nicht berührt oder auf diese tropft.
- ▶ Wenn das Kühl-/Gefriergerät längere Zeit leer steht, das Gerät ausschalten, abtauen, reinigen und die Tür offen lassen, um Schimmelbildung zu vermeiden.

Teile im Gerät aus Metall oder mit Metalloptik können Aluminium enthalten. Wenn saure Lebensmittel mit Aluminium in Kontakt kommen, können Aluminiumionen in die Lebensmittel übergehen.

- ▶ Verunreinigte Lebensmittel nicht verzehren.

## 1.7 Beschädigtes Gerät

### **WARNUNG – Stromschlaggefahr!**

Ein beschädigtes Gerät oder eine beschädigte Netzanschlussleitung ist gefährlich.

- ▶ Nie ein beschädigtes Gerät betreiben.
- ▶ Nie an der Netzanschlussleitung ziehen, um das Gerät vom Stromnetz zu trennen. Immer am Netzstecker der Netzanschlussleitung ziehen.
- ▶ Wenn das Gerät oder die Netzanschlussleitung beschädigt ist, sofort den Netzstecker der Netzanschlussleitung ziehen oder die Sicherung im Sicherungskasten ausschalten.
- ▶ Den Kundendienst rufen. → *Seite 25*

Unsachgemäße Reparaturen sind gefährlich.

- ▶ Nur dafür geschultes Fachpersonal darf Reparaturen am Gerät durchführen.
- ▶ Nur Original-Ersatzteile dürfen zur Reparatur des Geräts verwendet werden.
- ▶ Wenn die Netzanschlussleitung dieses Geräts beschädigt wird, muss sie durch den Hersteller oder seinen Kundendienst oder eine ähnlich qualifizierte Person ersetzt werden, um Gefährdungen zu vermeiden.

**⚠️ WARNUNG – Brandgefahr!**

Bei Beschädigung der Rohre können brennbares Kältemittel und schädliche Gase austreten und sich entzünden.

- ▶ Feuer und Zündquellen vom Gerät fernhalten.
- ▶ Den Raum lüften.
- ▶ Das Gerät ausschalten. → *Seite 15*
- ▶ Den Netzstecker der Netzanschlussleitung ziehen oder die Sicherung im Sicherungskasten ausschalten.
- ▶ Den Kundendienst rufen. → *Seite 25*

---

## 2 Sachschäden vermeiden

### ACHTUNG!

Durch Benutzung der Sockel, Auszüge oder Gerätertüren als Sitzfläche oder Steigfläche kann das Gerät beschädigt werden.

- ▶ Nicht auf Sockel, Auszüge oder Türen treten oder darauf abstützen.

Durch Verschmutzungen mit Öl oder Fett können Kunststoffteile und Türdichtungen porös werden.

- ▶ Kunststoffteile und Türdichtungen öl- und fettfrei halten.

Teile im Gerät aus Metall oder mit Metall-Optik können Aluminium enthalten. Aluminium reagiert bei Kontakt mit sauren Lebensmitteln.

- ▶ Keine Lebensmittel unverpackt im Gerät lagern.

---

## 3 Umweltschutz und Sparen

### 3.1 Verpackung entsorgen

Die Verpackungsmaterialien sind umweltverträglich und wiederverwertbar.

- ▶ Die einzelnen Bestandteile getrennt nach Sorten entsorgen.

### 3.2 Energie sparen

Wenn Sie diese Hinweise beachten, verbraucht Ihr Gerät weniger Strom.

#### Wahl des Aufstellorts

- Das Gerät vor direkter Sonneneinstrahlung schützen.
- Das Gerät mit möglichst großem Abstand zu Heizkörpern, Herd und anderen Wärmequellen aufstellen:

- 30 mm Abstand zu Elektro- oder Gasherden halten.
- 300 mm Abstand zu Öl- oder Kohleherden halten.
- Nie die äußeren Lüftungsöffnungen abdecken oder zustellen.

### Energie sparen beim Gebrauch

**Hinweis:** Die Anordnung der Ausstattungsteile hat keinen Einfluss auf den Energieverbrauch des Geräts.

- Das Gerät nur kurz öffnen und sorgfältig schließen.
- Nie die inneren Belüftungsöffnungen oder die äußeren Lüftungsöffnungen abdecken oder zustellen.
- Gekaufte Lebensmittel in einer Kühltasche transportieren und schnell ins Gerät legen.
- Warme Lebensmittel und Getränke vor dem Einlagern abkühlen lassen.
- Um die Kälte des Gefrierguts zu nutzen, das Gefriergut zum Auftauen ins Kühlfach legen.
- Zwischen den Lebensmitteln und zur Rückwand immer etwas Platz lassen.
- Das Gefrierfach regelmäßig abtauen.
- Das Gefrierfach nur kurz öffnen und sorgfältig schließen.

---

## 4 Aufstellen und Anschließen

### 4.1 Lieferumfang

Prüfen Sie nach dem Auspacken alle Teile auf Transportschäden und die Vollständigkeit der Lieferung. Bei Beanstandungen wenden Sie sich an Ihren Händler oder an unseren Kundendienst → Seite 25.



Die Lieferung besteht aus:

- Einbaugerät
- Ausstattung und Zubehör<sup>1</sup>
- Montagematerial
- Montageanleitung
- Gebrauchsanleitung
- Kundendienstverzeichnis
- Garantiebeilage<sup>2</sup>
- Energielabel
- Informationen zu Energieverbrauch und Geräuschen

## 4.2 Kriterien für den Aufstellort

### **WARNUNG** **Explosionsgefahr!**



Wenn das Gerät in einem zu kleinen Raum steht, kann bei einem Leck des Kältekreislaufs ein brennbares Gas-Luft-Gemisch entstehen.

- ▶ Das Gerät nur in einem Raum aufstellen, der mindestens ein Volumen von 1 m<sup>3</sup> pro 8 g Kältemittel hat. Die Menge des Kältemittels steht auf dem Typenschild.  
→ Abb.  / 

Das Gewicht des Geräts kann je nach Modell ab Werk bis zu 45 kg betragen.

Um das Gewicht des Geräts zu tragen, muss der Untergrund ausreichend stabil sein.

### **Zulässige Raumtemperatur**

Die zulässige Raumtemperatur hängt von der Klimaklasse des Geräts ab. Die Klimaklasse steht auf dem Typenschild. → Abb.  / 

Klimaklasse	Zulässige Raumtemperatur
SN	10 °C...32 °C

Klimaklasse	Zulässige Raumtemperatur
N	16 °C...32 °C
ST	16 °C...38 °C
T	16 °C...43 °C

Das Gerät ist innerhalb der zulässigen Raumtemperatur voll funktionsfähig.

Wenn Sie ein Gerät der Klimaklasse SN bei kälteren Raumtemperaturen betreiben, können Beschädigungen am Gerät bis zu einer Raumtemperatur von 5 °C ausgeschlossen werden.

### **Over-and-Under- und Side-by-Side-Aufstellung**

Wenn Sie 2 Kühlgeräte übereinander oder nebeneinander aufstellen wollen, müssen Sie zwischen den Geräten mindestens 150 mm Abstand halten. Für ausgewählte Geräte ist eine Aufstellung ohne Mindestabstand möglich. Fragen Sie dazu Ihren Fachhändler oder Küchenplaner.

## 4.3 Gerät montieren

- ▶ Das Gerät gemäß beiliegender Montageanleitung montieren.

## 4.4 Gerät für den ersten Gebrauch vorbereiten

1. Das Informationsmaterial entnehmen.
2. Die Schutzfolien und Transportsicherungen, z. B. Klebestreifen und Karton entfernen.
3. Das Gerät zum ersten Mal reinigen. → Seite 20

<sup>1</sup> Je nach Geräteausstattung

<sup>2</sup> Nicht in allen Ländern

## 4.5 Gerät elektrisch anschließen

1. Den Netzstecker der Netzanschlussleitung des Geräts in eine Steckdose in der Nähe des Geräts stecken.

Die Anschlussdaten des Geräts stehen auf dem Typenschild.

→ Abb. 1/4

2. Den Netzstecker auf festen Sitz prüfen.
- ✓ Das Gerät ist jetzt betriebsbereit.

---

## 5 Kennenlernen

### 5.1 Gerät

Hier finden Sie eine Übersicht über die Bestandteile Ihres Geräts.

→ Abb. 1

- 
- |   |  |
|---|--|
| 1 | Bedienfeld → Seite 14                      |
| 2 | Gefrierfach → Seite 17                     |
| 3 | Obst- und Gemüsebehälter → Seite 14        |
| 4 | Typenschild → Seite 26                     |
| 5 | Butter- und Käsefach → Seite 15            |
| 6 | Türabsteller für große Flaschen → Seite 15 |
- 

**Hinweis:** Abweichungen zwischen Ihrem Gerät und den Abbildungen sind hinsichtlich Ausstattung und Größe möglich.

### 5.2 Bedienfeld

Über das Bedienfeld stellen Sie alle Funktionen Ihres Geräts ein und erhalten Informationen zum Betriebszustand.

→ Abb. 2

- 
- |   |  |
|---|--|
| 1 | Die Temperatureinstelltaste stellt die Temperatur des Kühlfachs ein. |
| 2 | Super leuchtet, wenn Super-Kühlen eingeschaltet ist.                 |
| 3 | Zeigt die eingestellte Temperatur des Kühlfachs in °C an.            |
- 

---

## 6 Ausstattung

Die Ausstattung Ihres Geräts ist modellabhängig.

### 6.1 Ablage

Um die Ablage nach Bedarf zu variieren, können Sie die Ablage entnehmen und an anderer Stelle wieder einsetzen.

→ "Ablage entnehmen", Seite 20

### 6.2 Gefrierfachklappe

Lagern Sie auf der Ablage hinter der Gefrierfachklappe häufig verwendete oder kurzzeitig zu lagernde Lebensmittel.

### 6.3 Obst- und Gemüsebehälter

Lagern Sie frisches Obst und Gemüse verpackt im Obst- und Gemüsebehälter.

Angeschnittenes Obst und Gemüse abdeckt oder luftdicht verpackt einlagern.

Je nach Lagermenge und Lagergut kann sich im Obst- und Gemüsebehälter Kondenswasser bilden.

Das Kondenswasser mit einem trockenen Tuch entfernen.

Damit die Qualität und das Aroma erhalten bleiben, lagern Sie kälteempfindliches Obst und Gemüse außerhalb des Geräts bei Temperaturen von ca. 8 °C bis 12 °C, z. B. Ana-

nas, Bananen, Zitrusfrüchte, Gurken, Zucchini, Paprika, Tomaten und Kartoffeln.

## 6.4 Butter- und Käsefach

Lagern Sie Butter und Hartkäse im Butter- und Käsefach.

## 6.5 Türabsteller

Um den Türabsteller nach Bedarf zu variieren, können Sie den Türabsteller entnehmen und an anderer Stelle wieder einsetzen.

→ "Türabsteller entnehmen", Seite 20

## 6.6 Zubehör

Verwenden Sie Originalzubehör. Es ist auf Ihr Gerät abgestimmt. Das Zubehör Ihres Geräts ist modellabhängig.

### Eierablage

Lagern Sie Eier sicher auf der Eierablage.

### Flaschenablage

Lagern Sie Flaschen sicher auf der Flaschenablage.

→ Abb. 3

### Eiswürfelschale

Nutzen Sie die Eiswürfelschale, um Eiswürfel herzustellen.

### Eiswürfel herstellen

Verwenden Sie zur Herstellung von Eiswürfeln ausschließlich Trinkwasser.

1. Die Eiswürfelschale zu  $\frac{3}{4}$  mit Trinkwasser füllen und in das Gefrierfach stellen.

Festgefrorene Eiswürfelschale nur mit stumpfem Gegenstand, z. B. Löffelstiel lösen.

2. Zum Lösen der Eiswürfel die Eiswürfelschale kurz unter fließendes Wasser halten oder leicht verwinden.

---

# 7 Grundlegende Bedienung

## 7.1 Gerät einschalten

1. Das Gerät elektrisch anschließen.  
→ Seite 14

**Hinweis:** Wenn das Gerät zuvor über das Bedienfeld ausgeschaltet wurde, <sup>3 sec.</sup> ⓪ 3 Sekunden gedrückt halten.

- ✓ Das Gerät beginnt zu kühlen.
2. Die gewünschte Temperatur einstellen. → Seite 15

## 7.2 Hinweise zum Betrieb

- Wenn Sie das Gerät eingeschaltet haben, dauert es bis zu mehreren Stunden bis die eingestellte Temperatur erreicht wird. Keine Lebensmittel einlegen, bevor die eingestellte Temperatur erreicht ist.
- Wenn Sie die Tür schließen, kann ein Unterdruck entstehen. Die Tür lässt sich nur schwer wieder öffnen. Warten Sie einen Moment, bis sich der Unterdruck ausgleicht.

## 7.3 Gerät ausschalten

- ▶ <sup>3 sec.</sup> ⓪ 3 Sekunden gedrückt halten.

## 7.4 Temperatur einstellen

### Kühlfachtemperatur einstellen

- ▶ So oft die Temperatureinstelltaste drücken, bis die Temperaturanzeige die gewünschte Temperatur zeigt.

## de Zusatzfunktionen

Die empfohlene Temperatur im Kühlfach beträgt 4 °C.  
→ "Aufkleber OK", Seite 17

### Gefrierfachtemperatur einstellen

- ▶ Um die Gefrierfachtemperatur einzustellen, die Kühlfachtemperatur ändern → Seite 15.

Die Kühlfachtemperatur beeinflusst die Gefrierfachtemperatur. Wärmer eingestellte Kühlfachtemperaturen erzeugen wärmere Gefrierfachtemperaturen.

---

## 8 Zusatzfunktionen

### 8.1 Super-Funktion

Bei der Super-Funktion kühlt das Kühlfach und das Gefrierfach stärker. Schalten Sie die Super-Funktion 4 bis 6 Stunden vor dem Einlagern einer Lebensmittelmenge ab 2 kg ein. Um das Gefriervermögen auszunutzen, verwenden Sie die Super-Funktion.

→ "Gefriervermögen", Seite 17

**Hinweis:** Wenn die Super-Funktion eingeschaltet ist, kann es zu vermehrten Geräuschen kommen.

#### Super-Funktion einschalten

- ▶ So oft die Temperatureinstelltaste drücken, bis Super leuchtet.

**Hinweis:** Nach ca. 24 Stunden schaltet das Gerät auf Normalbetrieb.

#### Super-Funktion ausschalten

- ▶ Die Temperatureinstelltaste drücken.

---

## 9 Kühlfach

Im Kühlfach können Sie Fleisch, Wurst, Fisch, Milchprodukte, Eier, zubereitete Speisen und Backwaren aufbewahren.

Die Temperatur ist von 2 °C bis 8 °C einstellbar.

Durch die Kühlung können Sie auch leicht verderbliche Lebensmittel kurz- bis mittelfristig lagern. Je tiefer die gewählte Temperatur ist, desto länger bleiben die Lebensmittel frisch.

### 9.1 Tipps zum Einlagern von Lebensmitteln ins Kühlfach

- Nur frische und unversehrte Lebensmittel einlagern.
- Die Lebensmittel luftdicht verpackt oder abgedeckt einlagern.
- Um die Luftzirkulation nicht zu beeinträchtigen und das Gefrieren von Lebensmitteln zu vermeiden, die Lebensmittel nicht direkt an die Rückwand stellen.
- Warme Speisen und Getränke erst abkühlen lassen.
- Das vom Hersteller angegebene Mindesthaltbarkeitsdatum oder Verbrauchsdatum beachten.

### 9.2 Kältezonen im Kühlfach

Durch die Luftzirkulation im Kühlfach entstehen unterschiedliche Kältezonen.

#### Kälteste Zone

Die kälteste Zone ist zwischen dem seitlich eingepprägten Pfeil und der darunter liegenden Ablage.

**Tipp:** Lagern Sie leicht verderbliche Lebensmittel in der kältesten Zone, z. B. Fisch, Wurst und Fleisch.



## Wärmste Zone

Die wärmste Zone ist an der Tür ganz oben.

**Tipp:** Lagern Sie unempfindliche Lebensmittel in der wärmsten Zone, z. B. Hartkäse und Butter. Käse kann so sein Aroma weiter entfalten, die Butter bleibt streichfähig.

## 9.3 Aufkleber OK

Mit dem Aufkleber OK können Sie prüfen, ob im Kühlfach die für Lebensmittel empfohlenen sicheren Temperaturbereiche von +4 °C oder kälter erreicht sind.

Der Aufkleber OK ist nicht bei allen Modellen enthalten.

Wenn der Aufkleber nicht OK zeigt, Temperatur schrittweise verringern.  
→ *"Kühlfachtemperatur einstellen"*, Seite 15

Nach Inbetriebnahme des Geräts kann es bis zu 12 Stunden dauern, bis die eingestellte Temperatur erreicht ist.



Korrekte Einstellung

---

## 10 Gefrierfach

Im Gefrierfach können Sie Tiefkühlkost lagern, Lebensmittel einfrieren und Eiswürfel herstellen.

Die Temperatur im Gefrierfach ist abhängig von der Temperatur im Kühlfach.

Die langfristige Lagerung von Lebensmitteln sollte bei -18 °C oder darunter erfolgen.

Durch die Gefrierlagerung können Sie verderbliche Lebensmittel langfristig lagern. Die tiefen Temperaturen verlangsamen oder stoppen den Verderb.

### 10.1 Gefrierfachtür

Damit das eingelagerte Gefriergut nicht auftaut und das Gefrierfach nicht so stark vereist, schließen Sie immer die Gefrierfachtür.

### 10.2 Gefriervermögen

Das Gefriervermögen gibt an, welche Menge Lebensmittel in wie vielen Stunden bis zum Kern durchgefroren werden kann.

Angaben zum Gefriervermögen finden Sie auf dem Typenschild.

→ Abb. **1/4**

### Voraussetzungen für das Gefriervermögen

1. Beim Einlegen frischer Lebensmittel, Super-Funktion einschalten.  
→ *"Super-Funktion einschalten"*, Seite 16
2. Frische Lebensmittel möglichst hinten dicht an den Seitenwänden einfrieren.

### 10.3 Tipps zum Einlagern von Lebensmitteln ins Gefrierfach

- Die Lebensmittel luftdicht verpackt einlagern.
- Einzufrierende Lebensmittel nicht mit gefrorenen Lebensmitteln in Berührung bringen.
- Die Lebensmittel großflächig im Gefrierfach verteilen.

## 10.4 Tipps zum Einfrieren frischer Lebensmittel

- Nur frische und einwandfreie Lebensmittel einfrieren.
- Lebensmittel portionsweise einfrieren.
- Zubereitete Lebensmittel sind geeigneter als roh verzehrbare Lebensmittel.
- Gemüse vor dem Einfrieren waschen, zerkleinern und blanchieren.
- Obst vor dem Einfrieren waschen, entkernen und eventuell schälen, eventuell Zucker oder Ascorbinsäurelösung zufügen.
- Zum Einfrieren geeignete Lebensmittel sind z. B. Backwaren, Fisch und Meeresfrüchte, Fleisch, Wild und Geflügel, Eier ohne Schale, Käse, Butter, Quark, fertige Speisen und Speisereste.
- Zum Einfrieren ungeeignete Lebensmittel sind z. B. Blattsalate, Radieschen, Eier mit Schale, Weintrauben, rohe Äpfel und Birnen, Joghurt, saure Sahne, Crème Fraîche und Mayonnaise.

### Gefriergut verpacken

Geeignetes Verpackungsmaterial und die richtige Art der Verpackung erhalten maßgeblich die Produktqualität und vermeiden Gefrierbrand.

1. Die Lebensmittel in die Verpackung einlegen.
2. Die Luft herausdrücken.
3. Die Verpackung luftdicht verschließen, damit die Lebensmittel den Geschmack nicht verlieren oder austrocknen.
4. Die Verpackung mit dem Inhalt und dem Einfrierdatum beschriften.

## 10.5 Haltbarkeit des Gefrierguts bei $-18\text{ }^{\circ}\text{C}$

Lebensmittel	Lagerzeit
Fisch, Wurst, zubereitete Speisen, Backwaren	bis zu 6 Monate
Geflügel, Fleisch	bis zu 8 Monate
Gemüse, Obst	bis zu 12 Monate

## 10.6 Auftaumethoden für Gefriergut

### VORSICHT

#### Gefahr von Gesundheitsschäden!

Beim Auftauen können sich Bakterien vermehren und das Gefriergut kann verderben.

- ▶ An- oder aufgetautes Gefriergut nicht wieder einfrieren.
- ▶ Erst nach dem Kochen oder Braten erneut einfrieren.
- ▶ Die maximale Lagerdauer nicht mehr voll nutzen.
- Tierische Lebensmittel im Kühlfach auftauen, z. B. Fisch, Fleisch, Käse und Quark.
- Brot bei Raumtemperatur auftauen.
- Lebensmittel zum sofortigen Verzehr in der Mikrowelle, im Backofen oder auf dem Herd zubereiten.

---

## 11 Abtauen

### 11.1 Abtauen im Kühlfach

Im Betrieb bilden sich an der Rückwand des Kühlfachs funktionsbedingt Tauwassertropfen oder Reif. Die Rückwand im Kühlfach taut automatisch ab.

→ *Abb. 4*

Das Tauwasser läuft über die Tauwasserrinne in das Ablaufloch zur Verdunstungsschale und muss nicht abgewischt werden.

Damit das Tauwasser ablaufen kann und Geruchsbildung vermieden wird, beachten Sie folgende Informationen:

→ *"Tauwasserrinne und Ablaufloch reinigen", Seite 20.*

### 11.2 Abtauen im Gefrierfach

Das Gefrierfach taut nicht automatisch ab. Eine Reifschicht im Gefrierfach verschlechtert die Kälteabgabe an das Gefriergut und erhöht den Stromverbrauch.

#### Gefrierfach abtauen

Tauen Sie das Gefrierfach regelmäßig ab.

1. Ca. 4 Stunden vor dem Abtauen die Super-Funktion einschalten.  
→ *"Super-Funktion einschalten", Seite 16*  
Die Lebensmittel erreichen dadurch sehr tiefe Temperaturen und Sie können die Lebensmittel länger bei Raumtemperatur lagern.
2. Das Gefriergut entnehmen und an einem kühlen Ort zwischenlagern. Das Gefriergut in Decken oder Zeitungspapier mit Kälteakkus, wenn vorhanden, einwickeln.
3. Das Gerät ausschalten. → *Seite 15*
4. Das Gerät vom Stromnetz trennen.

Den Netzstecker der Netzanschlussleitung ziehen oder die Sicherung im Sicherungskasten ausschalten.

5. Um den Abtauvorgang zu beschleunigen, einen Topf mit heißem Wasser auf einem Topfuntersetzer in das Gefrierfach stellen.
6. Das Tauwasser mit einem weichen Tuch oder einem Schwamm aufwischen.
7. Das Gefrierfach mit einem weichen, trockenen Tuch trocken reiben.
8. Das Gerät elektrisch anschließen.  
→ *Seite 14*
9. Das Gefriergut einlegen.  
→ *Seite 17*

---

## 12 Reinigen und Pflegen

Damit Ihr Gerät lange funktionsfähig bleibt, reinigen und pflegen Sie es sorgfältig.

Die Reinigung von unzugänglichen Stellen muss durch den Kundendienst erfolgen. Die Reinigung durch den Kundendienst kann Kosten verursachen.

### 12.1 Gerät zum Reinigen vorbereiten

1. Das Gerät ausschalten. → *Seite 15*
2. Das Gerät vom Stromnetz trennen.  
Den Netzstecker der Netzanschlussleitung ziehen oder die Sicherung im Sicherungskasten ausschalten.
3. Alle Lebensmittel entnehmen und an einem kühlen Ort lagern.  
Wenn vorhanden, Kälteakkus auf die Lebensmittel legen.
4. Wenn eine Reifschicht vorhanden ist, diese abtauen lassen.

5. Alle Ausstattungsteile und Zubehörteile aus dem Gerät nehmen.  
→ Seite 20

## 12.2 Gerät reinigen

### **WARNUNG**

#### **Stromschlaggefahr!**

Eindringende Feuchtigkeit kann einen Stromschlag verursachen.

- ▶ Keinen Dampfreiniger oder Hochdruckreiniger verwenden, um das Gerät zu reinigen.

Flüssigkeit in der Beleuchtung oder in den Bedienelementen kann gefährlich sein.

- ▶ Das Spülwasser darf nicht in die Beleuchtung oder in die Bedienelemente gelangen.

### **ACHTUNG!**

Ungeeignete Reinigungsmittel können die Oberflächen des Geräts beschädigen.

- ▶ Keine harten Scheuerkissen oder Putzschwämme verwenden.
- ▶ Keine scharfen oder scheuernden Reinigungsmittel verwenden.
- ▶ Keine stark alkoholhaltigen Reinigungsmittel verwenden.

Wenn Flüssigkeit in das Ablaufloch gelangt, kann die Verdunstungsschale überlaufen.

- ▶ Das Spülwasser darf nicht in das Ablaufloch gelangen.

Wenn Sie Ausstattungsteile und Zubehör im Geschirrspüler reinigen, können sich diese verformen oder verfärben.

- ▶ Nie Ausstattungsteile und Zubehör im Geschirrspüler reinigen.

1. Das Gerät zum Reinigen vorbereiten. → Seite 19

2. Das Gerät, die Ausstattungsteile, die Zubehörteile und die Türdichtungen mit einem Spültuch, lauwarmem Wasser und etwas pH-neutralem Spülmittel reinigen.
3. Mit einem weichen, trockenen Tuch gründlich nachtrocknen.
4. Die Ausstattungsteile einsetzen.
5. Das Gerät elektrisch anschließen.  
→ Seite 14
6. Die Lebensmittel einlegen.

## 12.3 Tauwasserrinne und Ablaufloch reinigen

Damit das Tauwasser ablaufen kann, reinigen Sie die Tauwasserrinne und das Ablaufloch regelmäßig.

- ▶ Die Tauwasserrinne und das Ablaufloch vorsichtig reinigen, z. B. mit einem Wattestäbchen.  
→ Abb. 5

## 12.4 Ausstattungsteile entnehmen

Wenn Sie die Ausstattungsteile gründlich reinigen wollen, entnehmen Sie diese aus Ihrem Gerät.

### **Ablage entnehmen**

- ▶ Die Ablage vorn anheben ①, herausziehen und entnehmen ②.  
→ Abb. 6

### **Gefrierfachklappe entfernen**

- ▶ Die Gefrierfachklappe öffnen und von der Halterung lösen.  
→ Abb. 7

### **Türabsteller entnehmen**

- ▶ Den Türabsteller anheben und entnehmen.  
→ Abb. 8

## **Obst- und Gemüsebehälter entnehmen**

1. Den Obst- und Gemüsebehälter bis zum Anschlag herausziehen.
2. Den Obst- und Gemüsebehälter vorn anheben ① und entnehmen ②

→ *Abb. 9*

## 13 Störungen beheben

Kleinere Störungen an Ihrem Gerät können Sie selbst beheben. Nutzen Sie die Informationen zur Störungsbehebung, bevor Sie den Kundendienst kontaktieren. So vermeiden Sie unnötige Kosten.

### **WARNUNG** **Stromschlaggefahr!**

Unsachgemäße Reparaturen sind gefährlich.

- ▶ Nur dafür geschultes Fachpersonal darf Reparaturen am Gerät durchführen.
- ▶ Nur Original-Ersatzteile dürfen zur Reparatur des Geräts verwendet werden.
- ▶ Wenn die Netzanschlussleitung dieses Geräts beschädigt wird, muss sie durch den Hersteller oder seinen Kundendienst oder eine ähnlich qualifizierte Person ersetzt werden, um Gefährdungen zu vermeiden.

<b>Störung</b>	<b>Ursache und Störungsbehebung</b>
Gerät kühlt nicht, Anzeigen und Beleuchtung leuchten.	Ausstellungsmodus ist eingeschaltet. <ul style="list-style-type: none"><li>▶ Führen Sie den Geräteselbsttest durch. → <i>Seite 24</i></li><li>✓ Nach Ablauf des Geräteselbsttest geht das Gerät in den Normalbetrieb über.</li></ul>
LED-Beleuchtung funktioniert nicht.	Unterschiedliche Ursachen sind möglich. <ul style="list-style-type: none"><li>▶ Rufen Sie den Kundendienst.</li></ul> Die Kundendienstnummer finden Sie im beiliegenden Kundendienstverzeichnis.
Temperatur weicht stark von der Einstellung ab.	Unterschiedliche Ursachen sind möglich. <ol style="list-style-type: none"><li>1. Schalten Sie das Gerät aus. → <i>Seite 15</i></li><li>2. Schalten Sie das Gerät nach ca. 5 Minuten wieder ein. → <i>Seite 15</i><ul style="list-style-type: none"><li>– Wenn die Temperatur zu warm ist, prüfen Sie die Temperatur nach ein paar Stunden erneut.</li><li>– Wenn die Temperatur zu kalt ist, prüfen Sie die Temperatur am Folgetag erneut.</li></ul></li></ol>
Boden des Kühlfachs ist nass.	Tauwasserrinne oder Ablaufloch sind verstopft. <ul style="list-style-type: none"><li>▶ Reinigen Sie die Tauwasserrinne und das Ablaufloch. → <i>Seite 20</i></li></ul>
Gerät brummt, blubbert, surrt, gurgelt oder klickt.	Kein Fehler. Ein Motor läuft, z. B. Kälteaggregat, Ventilator. Kältemittel fließt durch die Rohre. Motor, Schalter oder Magnetventile schalten ein oder aus. Keine Handlung notwendig.
Gerät macht Geräusche.	Ausstattungsteile wackeln oder klemmen. <ul style="list-style-type: none"><li>▶ Prüfen Sie die entnehmbaren Ausstattungsteile und setzen Sie diese eventuell neu ein.</li></ul> Flaschen oder Gefäße berühren sich.

<b>Störung</b>	<b>Ursache und Störungsbehebung</b>
Gerät macht Geräusche.	<ul style="list-style-type: none"><li>▶ Rücken Sie die Flaschen oder Gefäße auseinander.</li></ul> Super-Funktion ist eingeschaltet. Keine Handlung notwendig.

## 13.1 Stromausfall

Während eines Stromausfalls steigt die Temperatur im Gerät, dadurch verkürzt sich die Lagerzeit und die Qualität des Gefrierguts verringert sich.

Auf unserer Webseite zu Ihrem Gerät finden Sie in den technischen Daten die Lagerzeit des Gefrierguts bei einer Störung.

### Hinweise

- Das Gerät während eines Stromausfalls möglichst wenig öffnen und keine weiteren Lebensmittel einlagern.
- Die Qualität der Lebensmittel unmittelbar nach dem Stromausfall überprüfen.
  - Gefriergut, das angetaut und wärmer als 5 °C ist, entsorgen.
  - Leicht angetautes Gefriergut kochen oder braten und entweder verzehren oder wieder einfrieren.

## 13.2 Geräteselbsttest durchführen

1. Das Gerät ausschalten. → *Seite 15*
2. Das Gerät vom Stromnetz trennen. Den Netzstecker der Netzanschlussleitung ziehen oder die Sicherung im Sicherungskasten ausschalten.
3. Das Gerät nach 5 Minuten wieder elektrisch anschließen. → *Seite 14*
4. Innerhalb von 10 Sekunden nach dem Einschalten die Temperatureinstelltaste für 5 bis 7 Sekunden gedrückt halten, bis ein zweites akustisches Signal ertönt.
  - ✓ Der Geräteselbsttest startet.
  - ✓ Während des Geräteselbsttests ertönt zwischendurch ein langes akustisches Signal.

- ✓ Wenn nach Ende des Geräteselbsttests 2 akustische Signale ertönen und **Super** zweimal blinkt, ist Ihr Gerät in Ordnung. Das Gerät geht in den Normalbetrieb über.
- ✓ Wenn nach Ende des Geräteselbsttests 5 akustische Signale ertönen und **Super** für 10 Sekunden blinkt, den Kundendienst benachrichtigen.

---

## 14 Lagern und Entsorgen

Erfahren Sie hier, wie Sie Ihr Gerät für die Lagerung vorbereiten. Außerdem erfahren Sie, wie Sie Altgeräte entsorgen.

### 14.1 Gerät außer Betrieb nehmen

1. Das Gerät ausschalten. → *Seite 15*
2. Das Gerät vom Stromnetz trennen. Den Netzstecker der Netzanschlussleitung ziehen oder die Sicherung im Sicherungskasten ausschalten.
3. Alle Lebensmittel entnehmen.
4. Das Gerät abtauen. → *Seite 19*
5. Das Gerät reinigen. → *Seite 20*
6. Um die Belüftung des Innenraums sicherzustellen, das Gerät geöffnet lassen.



## 14.2 Altgerät entsorgen

Durch umweltgerechte Entsorgung können wertvolle Rohstoffe wiederverwendet werden.

### **WARNUNG**

#### **Gefahr von Gesundheitsschäden!**

Kinder können sich im Gerät einsperren und in Lebensgefahr geraten.

- ▶ Um Kindern das Hineinklettern zu erschweren, Ablagen und Behälter nicht aus dem Gerät nehmen.
- ▶ Kinder vom ausgedienten Gerät fernhalten.

### **WARNUNG**

#### **Brandgefahr!**

Bei Beschädigung der Rohre können brennbares Kältemittel und schädliche Gase austreten und sich entzünden.

- ▶ Nicht die Rohre des Kältemittel-Kreislaufs und die Isolierung beschädigen.

1. Den Netzstecker der Netzanschlussleitung ziehen.
2. Die Netzanschlussleitung durchtrennen.
3. Das Gerät umweltgerecht entsorgen.

Informationen über aktuelle Entsorgungswege erhalten Sie bei Ihrem Fachhändler sowie Ihrer Gemeinde- oder Stadtverwaltung.



Dieses Gerät ist entsprechend der europäischen Richtlinie 2012/19/EU über Elektro- und Elektronikaltgeräte (waste

electrical and electronic equipment – WEEE) gekennzeichnet.

Die Richtlinie gibt den Rahmen für eine EU-weit gültige Rücknahme und Verwertung der Altgeräte vor.

## 15 Kundendienst

Wenn Sie Fragen haben, eine Störung am Gerät nicht selbst beheben können oder das Gerät repariert werden muss, wenden Sie sich an unseren Kundendienst.

Funktionsrelevante Original-Ersatzteile gemäß der entsprechenden Ökodesign-Verordnung erhalten Sie bei unserem Kundendienst für die Dauer von mindestens 10 Jahren ab dem Inverkehrbringen Ihres Geräts innerhalb des Europäischen Wirtschaftsraums.

**Hinweis:** Der Einsatz des Kundendienstes ist im Rahmen der jeweils lokal geltenden Herstellergarantiebedingungen kostenlos. Die Mindestdauer der Garantie (Herstellergarantie für Privatverbraucher) im Europäischen Wirtschaftsraum beträgt 2 Jahre gemäß den geltenden lokalen Garantiebedingungen. Die Garantiebedingungen haben keine Auswirkungen auf andere Rechte oder Ansprüche, die Ihnen nach lokalem Recht zustehen.

Detaillierte Informationen über die Garantiedauer und die Garantiebedingungen in Ihrem Land erhalten Sie bei unserem Kundendienst, Ihrem Händler oder auf unserer Webseite. Wenn Sie den Kundendienst kontaktieren, benötigen Sie die Erzeugnisnummer (E-Nr.) und die Fertigungsnummer (FD) Ihres Geräts.

## de Technische Daten

Die Kontaktdaten des Kundendienstes finden Sie im beiliegenden Kundendienstverzeichnis oder auf unserer Webseite.

### 15.1 Erzeugnisnummer (E-Nr.) und Fertigungsnummer (FD)

Die Erzeugnisnummer (E-Nr.) und die Fertigungsnummer (FD) finden Sie auf dem Typenschild des Geräts.

→ Abb. **1**/4

Um Ihre Gerätedaten und die Kundendienst-Telefonnummer schnell wiederzufinden, können Sie die Daten notieren.

---

## 16 Technische Daten

Kältemittel, Nutzinhalt und weitere technische Angaben befinden sich auf dem Typenschild.

→ Abb. **1**/4

Dieses Produkt enthält eine Lichtquelle der Energie-Effizienzklasse E. Die Lichtquelle ist als Ersatzteil verfügbar und nur durch dafür geschultes Fachpersonal auszutauschen.

Weitere Informationen zu Ihrem Modell finden Sie im Internet unter <https://eprel.ec.europa.eu/><sup>1</sup>. Diese Webadresse verlinkt auf die offizielle EU-Produktdatenbank EPREL. Bitte folgen Sie dann den Anweisungen der Modellsuche. Die Modellkennung ergibt sich aus den Zeichen vor dem Schrägstrich der Erzeugnisnummer (E-Nr.) auf dem Typenschild. Alternativ finden Sie die Modellkennung auch in der ersten Zeile des EU-Energielabels.

---

<sup>1</sup> Gilt nur für Länder im Europäischen Wirtschaftsraum

## Table des matières

<b>1 Sécurité.....</b>	<b>29</b>	<b>7 Utilisation .....</b>	<b>40</b>
1.1 Indications générales .....	29	7.1 Allumer l'appareil .....	40
1.2 Utilisation conforme.....	29	7.2 Remarques concernant le fonctionnement de l'appareil....	40
1.3 Restrictions du périmètre uti- lisateurs .....	29	7.3 Éteindre l'appareil.....	40
1.4 Prescriptions-d'hygiène-ali- mentaire.....	30	7.4 Régler la température .....	40
1.5 Transport sûr .....	30	<b>8 Fonctions additionnelles .....</b>	<b>40</b>
1.6 Installation sûre .....	31	8.1 Super-fonction .....	40
1.7 Utilisation sûre.....	32	<b>9 Compartiment réfrigération.....</b>	<b>41</b>
1.8 Appareil endommagé.....	34	9.1 Conseils pour ranger des produits alimentaires dans le compartiment réfrigération .....	41
<b>2 Prévenir les dégâts matériels....</b>	<b>36</b>	9.2 Zones froides dans le com- partiment réfrigération .....	41
<b>3 Protection de l'environne- ment et économies d'énergie ....</b>	<b>36</b>	9.3 Autocollant « OK » .....	41
3.1 Élimination de l'emballage .....	36	<b>10 Compartiment congélation.....</b>	<b>42</b>
3.2 Économies d'énergie .....	36	10.1 Porte du congélateur.....	42
<b>4 Installation et branchement.....</b>	<b>37</b>	10.2 Capacité de congélation .....	42
4.1 Contenu de la livraison .....	37	10.3 Conseils pour ranger des aliments dans le comparti- ment congélation.....	42
4.2 Critères pour le lieu d'instal- lation.....	37	10.4 Conseils pour congeler des aliments frais .....	42
4.3 Monter l'appareil.....	38	10.5 Durée de conservation du produit congelé à -18 °C.....	43
4.4 Préparation de l'appareil pour la première utilisation.....	38	10.6 Méthodes de décongéla- tion pour aliments congelés...	43
4.5 Raccordement électrique de l'appareil.....	38	<b>11 Dégivrage .....</b>	<b>44</b>
<b>5 Description de l'appareil.....</b>	<b>38</b>	11.1 Dégivrage du comparti- ment réfrigération .....	44
5.1 Appareil .....	38	11.2 Décongélation dans le compartiment congélation .....	44
5.2 Bandeau de commande .....	38	<b>12 Nettoyage et entretien .....</b>	<b>44</b>
<b>6 Équipement .....</b>	<b>39</b>	12.1 Préparer l'appareil pour le nettoyage.....	44
6.1 Clayette.....	39	12.2 Nettoyage de l'appareil .....	45
6.2 Trappe du compartiment congélation.....	39		
6.3 Bac(s) à fruits et légumes.....	39		
6.4 Casier à beurre et à fromage...	39		
6.5 Compartiment dans la contreporte .....	39		
6.6 Accessoires.....	39		

12.3 Nettoyer la rigole à eau de dégivrage et le trou d'écoulement.....	45
12.4 Retirer les pièces d'équipement.....	46
<b>13 Dépannage .....</b>	<b>47</b>
13.1 Panne de courant.....	49
13.2 Effectuer l'auto-test de l'appareil.....	49
<b>14 Entreposage et élimination .....</b>	<b>49</b>
14.1 Mise hors service de l'appareil.....	49
14.2 Mettre au rebut un appareil usagé.....	50
<b>15 Service après-vente .....</b>	<b>50</b>
15.1 Numéro de produit (E-Nr) et numéro de fabrication (FD) .....	51
<b>16 Caractéristiques techniques ...</b>	<b>51</b>



# 1 Sécurité

Respectez les consignes de sécurité suivantes.

## 1.1 Indications générales

- Lisez attentivement cette notice.
- Conservez la notice ainsi que les informations produites en vue d'une réutilisation ultérieure ou pour un futur nouveau propriétaire.
- Ne branchez pas l'appareil si ce dernier a été endommagé durant le transport.

## 1.2 Utilisation conforme

Cet appareil est conçu pour être encastré uniquement.

Utilisez l'appareil uniquement :

- pour réfrigérer et congeler des aliments, et pour préparer des glaçons.
- pour un usage privé et dans les pièces fermées d'un domicile.
- jusqu'à une hauteur maximale de 2 000 m au-dessus du niveau de la mer.

## 1.3 Restrictions du périmètre utilisateurs

Les enfants de 8 ans et plus, les personnes souffrant d'un handicap physique, sensoriel ou mental ou ne détenant pas l'expérience et/ou les connaissances nécessaires pourront utiliser cet appareil à condition de le faire sous surveillance, ou que son utilisation sûre leur ait été enseignée et qu'ils aient compris les dangers qui en émanent.

Les enfants ne sont pas autorisés à jouer avec l'appareil.

Le nettoyage de l'appareil, et l'entretien par l'utilisateur, sont des activités que les enfants ne peuvent pas effectuer sans surveillance.

Les enfants à partir de 3 ans et ceux âgés de moins de 8 ans peuvent charger et décharger l'appareil de réfrigération/congélation.

## 1.4 Prescriptions-d'hygiène-alimentaire

Conformément à la réglementation française visant à empêcher la présence de listeria dans le compartiment réfrigérateur, nous vous remercions de respecter les consignes suivantes.

- Nettoyez fréquemment le compartiment intérieur du réfrigérateur à l'aide d'un détergent non agressif, ne provoquant pas d'oxydation des pièces métalliques (utilisez par ex. de l'eau tiède additionnée d'un peu de produit à vaisselle).  
Ensuite, désinfectez avec de l'eau additionnée de vinaigre ou de jus de citron les surfaces que vous avez préalablement nettoyées, ou utilisez un produit germicide en vente dans le commerce et adapté aux réfrigérateurs (avant d'utiliser ce produit sur les pièces métalliques, faites un test de compatibilité à un endroit peu visible).
- Enlevez les emballages commerciaux avant de mettre les produits alimentaires dans le compartiment réfrigérateur (par ex. le carton qui réunit les pots de yaourt).
- Pour éviter toute contamination entre des produits alimentaires de nature différente, rangez-les bien séparés les uns des autres, bien emballés ou rangés dans des récipients à couvercle.
- Avant de préparer des plats et de saisir des produits alimentaires, lavez-vous les mains. Avant de préparer d'autres plats, lavez-vous à nouveau les mains. Lavez-les encore une fois avant de prendre un repas.
- Lavez les ustensiles de cuisine dont vous venez de vous servir avant de les réutiliser (cuillère en bois, planche de découpe, couteau de cuisine, etc.).

## 1.5 Transport sûr

### **AVERTISSEMENT – Risque de blessure !**

Le soulèvement du poids élevé de l'appareil peut entraîner des blessures.

- ▶ Ne soulevez jamais seul l'appareil.

## 1.6 Installation sûre

### **⚠ AVERTISSEMENT – Risque d'électrocution !**

Les installations non conformes sont dangereuses.

- ▶ Pour le raccordement et l'utilisation de l'appareil, respectez impérativement les indications figurant sur la plaque signalétique.
- ▶ L'appareil doit être branché uniquement à une source d'alimentation avec courant alternatif à l'aide d'une prise murale correctement installée et reliée à la terre.
- ▶ Le système à conducteur de protection de l'installation électrique de la maison doit être conforme.
- ▶ N'alimentez jamais l'appareil par l'intermédiaire d'un appareil de commutation externe, par ex. une minuterie ou une télécommande.
- ▶ Si l'appareil est encastré, la fiche du cordon d'alimentation secteur doit être librement accessible ou, si un accès libre est impossible, un dispositif de sectionnement tous pôles doit être installé dans l'installation électrique fixe, conformément aux réglementations d'installation.
- ▶ Lors de l'installation de l'appareil, veiller à ce que le cordon d'alimentation secteur ne soit pas coincé ni endommagé.

Le cordon d'alimentation pose un danger si sa gaine de protection est endommagée.

- ▶ Ne mettez jamais en contact le cordon d'alimentation avec des sources de chaleur.

### **⚠ AVERTISSEMENT – Risque d'explosion !**

Si les orifices de ventilation de l'appareil sont fermés, un mélange gaz-air inflammable peut se produire si le circuit de réfrigération fuit.

- ▶ Ne fermez pas les orifices de ventilation dans le boîtier de l'appareil ou dans le boîtier d'installation.

### **⚠ AVERTISSEMENT – Risque d'incendie !**

Un cordon d'alimentation secteur prolongé ainsi qu'un adaptateur non agréé sont dangereux.

- ▶ Ne pas utiliser de rallonge ni de bloc multiprise.

- ▶ Si le cordon d'alimentation secteur est trop court, contacter le service après-vente.
- ▶ Utiliser uniquement des adaptateurs agréés par le fabricant. Les blocs multiprises ou blocs secteur mobiles peuvent surchauffer et provoquer un incendie.
- ▶ Ne placez pas les blocs multiprises ou blocs secteur mobiles à l'arrière des appareils.

## 1.7 Utilisation sûre

### **⚠ AVERTISSEMENT – Risque d'électrocution !**

L'infiltration d'humidité peut occasionner un choc électrique.

- ▶ Utiliser l'appareil uniquement dans des pièces fermées.
- ▶ Ne jamais exposer l'appareil à une forte chaleur ou humidité.
- ▶ Ne pas utiliser de nettoyeur vapeur ou haute pression pour nettoyer l'appareil.

### **⚠ AVERTISSEMENT – Risque d'asphyxie !**

Les enfants risquent de s'envelopper dans les matériaux d'emballage ou de les mettre sur la tête et de s'étouffer.

- ▶ Conserver les matériaux d'emballage hors de portée des enfants.
- ▶ Ne jamais laisser les enfants jouer avec les emballages.

Les enfants risquent d'inhaler ou d'avalier des petits morceaux et s'étouffer.

- ▶ Conserver les petites pièces hors de portée des enfants.
- ▶ Ne pas laisser les enfants jouer avec les petites pièces.

### **⚠ AVERTISSEMENT – Risque d'explosion !**

L'endommagement du circuit de réfrigération peut provoquer la fuite et l'explosion du fluide frigorigène inflammable.

- ▶ Pour accélérer le dégivrage, n'utilisez pas d'autres équipements mécaniques ou d'autres produits que ceux recommandés par le fabricant.
- ▶ Détachez les aliments congelés à l'aide d'un objet émoussé, par exemple le manche d'une cuillère en bois.



Des produits contenant des gaz propulseurs inflammables et des matières explosives peuvent exploser, par ex. bombes aérosols.

- ▶ Ne pas stocker de produits contenant des gaz propulseurs inflammables et des matières explosives dans l'appareil.

### **⚠ AVERTISSEMENT – Risque d'incendie !**

Les appareils électriques à l'intérieur de l'appareil peuvent provoquer un incendie, par ex. appareils de chauffage ou fabriques de glace électriques.

- ▶ N'utilisez aucun appareil électrique à l'intérieur de l'appareil.

### **⚠ AVERTISSEMENT – Risque de blessure !**

Les récipients contenant des boissons gazeuses risquent d'éclater.

- ▶ Ne jamais ranger de boissons gazeuses dans le compartiment congélation.

Lésions oculaires dues à la fuite de fluide frigorigène inflammable et de gaz nocifs.

- ▶ Veillez à ne pas endommager les tubulures du circuit frigorifique, ni l'isolant.

### **⚠ AVERTISSEMENT – Risque de brûlures par le froid !**

Un contact avec les produits congelés et les surfaces froides peut entraîner des brûlures par le froid.

- ▶ Ne portez jamais des produits surgelés à la bouche immédiatement après les avoir sortis du compartiment congélation.
- ▶ Évitez tout contact prolongé de la peau avec les produits congelés, la glace et les surfaces métalliques présents dans le compartiment congélation.

### **⚠ PRUDENCE – Risque de préjudice pour la santé !**

Pour éviter toute contamination des produits alimentaires, respecter les instructions suivantes.

- ▶ L'ouverture prolongée de la porte peut entraîner une importante augmentation de la température dans les compartiments de l'appareil.

- ▶ Nettoyer régulièrement les surfaces qui peuvent entrer en contact avec des produits alimentaires et systèmes d'écoulement accessibles.
- ▶ Conserver la viande et le poisson crus dans des récipients appropriés dans le compartiment réfrigération de sorte qu'ils ne soient pas en contact avec d'autres aliments et qu'ils ne coulent pas dessus.
- ▶ Si le réfrigérateur/congélateur reste vide pendant une longue période, éteindre l'appareil, le dégivrer, le nettoyer et laisser la porte ouverte, afin d'éviter la formation de moisissures.

Les pièces métalliques ou d'aspect métallique de l'appareil peuvent contenir de l'aluminium. Si des aliments acides entrent en contact avec de l'aluminium, des ions d'aluminium peuvent être transférés dans les aliments.

- ▶ Ne consommez pas les aliments contaminés.

## 1.8 Appareil endommagé

### **⚠ AVERTISSEMENT – Risque d'électrocution !**

Un appareil endommagé ou un cordon d'alimentation secteur endommagé est dangereux.

- ▶ N'utilisez jamais un appareil endommagé.
- ▶ Ne tirez jamais sur le cordon d'alimentation secteur pour débrancher l'appareil du secteur. Débranchez toujours la fiche du cordon d'alimentation secteur.
- ▶ Si l'appareil ou le cordon d'alimentation secteur est endommagé, débranchez immédiatement le cordon d'alimentation secteur ou coupez le fusible dans le boîtier à fusibles.
- ▶ Appelez le service après-vente. → *Page 50*

Les réparations non conformes sont dangereuses.

- ▶ Seul un personnel dûment qualifié peut entreprendre des réparations sur l'appareil.
- ▶ Seules des pièces de rechange d'origine peuvent être utilisées pour réparer l'appareil.

- ▶ Afin d'écartier tout danger quand le cordon d'alimentation secteur de cet appareil est endommagé, seul le fabricant ou son service après-vente ou toute autre personne de qualification équivalente est habilité à le remplacer.

**⚠ AVERTISSEMENT – Risque d'incendie !**



En cas d'endommagement des tuyaux, du fluide frigorigène inflammable et des gaz nocifs peuvent s'échapper et s'enflammer.

- ▶ Éloigner de l'appareil toute flamme ou source d'inflammation.
- ▶ Aérer la pièce.
- ▶ Éteindre l'appareil. → *Page 40*
- ▶ Débrancher la fiche secteur du cordon d'alimentation secteur ou désactiver le fusible dans le boîtier à fusibles.
- ▶ Appeler le service après-vente. → *Page 50*

---

## 2 Prévenir les dégâts matériels

### ATTENTION !

L'utilisation du socle, des glissières ou des portes de l'appareil comme surface d'assise ou comme marchepied peut endommager l'appareil.

- ▶ Ne jamais se servir du socle, des glissières ou des portes comme marchepied et ne pas s'appuyer dessus.

En cas de salissures provenant d'huile ou de graisse, des pièces en matière plastique et les joints de porte peuvent devenir poreux.

- ▶ Veiller à ce que les pièces en matière plastique et les joints de porte restent exempts d'huile et de graisse.

Les pièces métalliques ou d'aspect métallique de l'appareil peuvent contenir de l'aluminium. L'aluminium réagit en contact avec les aliments acides.

- ▶ Ne stockez pas d'aliments non emballés dans l'appareil.

---

## 3 Protection de l'environnement et économies d'énergie

### 3.1 Élimination de l'emballage

Les emballages sont écologiques et recyclables.

- ▶ Veuillez éliminer les pièces détachées après les avoir triées par matière.



---

Éliminez l'emballage en respectant l'environnement.

---

### 3.2 Économies d'énergie

Si vous respectez les instructions suivantes, votre appareil consommera moins de courant.

#### Choix du lieu d'installation

- Protégez l'appareil de la lumière directe du soleil.
- Installez l'appareil aussi loin que possible des radiateurs, des cuisinières et des autres sources de chaleur :
  - Respecter une distance de 30 mm par rapport aux cuisinières électriques ou à gaz.
  - Respectez une distance de 300 mm par rapport à un appareil de chauffage au fuel ou au charbon.
- Ne recouvrez et ne bouchez jamais les orifices de ventilation extérieurs.

#### Économiser de l'énergie lors de l'utilisation

**Remarque :** La disposition des pièces d'équipement n'a aucune influence sur la consommation d'énergie de l'appareil.

- N'ouvrez que brièvement l'appareil et fermez-le avec précaution.
- Ne recouvrez et n'obstruez jamais les grilles de ventilation intérieures ni les orifices de ventilation extérieurs.
- Transportez les aliments achetés dans un sac isotherme et rangez-les rapidement dans l'appareil.
- Attendez que les aliments et les boissons chaudes refroidissent avant de les ranger.
- Pour profiter du froid des produits congelés, placez les produits à décongeler dans le compartiment réfrigération.

- Laissez toujours un peu de place entre les aliments et la paroi arrière.
- Dégivrez régulièrement le compartiment congélation.
- N'ouvrez que brièvement le compartiment congélation et fermez-le avec précaution.

## 4 Installation et branchement

### 4.1 Contenu de la livraison

Après avoir déballé le produit, inspectez toutes les pièces pour détecter d'éventuels dégâts dus au transport et vous assurer de l'intégralité de la livraison.

En cas de réclamation, veuillez vous adresser à votre revendeur ou à notre service après-vente  
→ Page 50.

La livraison comprend :

- Appareil encastrable
- Des équipements et accessoires<sup>1</sup>
- Matériel de montage
- Instructions de montage
- La notice d'utilisation
- Les coordonnées du service après-vente
- Le document annexe de la garantie<sup>2</sup>
- Le label énergétique
- Des informations relatives à la consommation d'énergie et aux bruits

<sup>1</sup> Selon l'équipement de l'appareil

<sup>2</sup> Pas dans tous les pays

### 4.2 Critères pour le lieu d'installation

#### **AVERTISSEMENT** **Risque d'explosion !**

Si l'appareil est installé dans une pièce trop petite, une éventuelle fuite du circuit de réfrigération pourrait donner lieu à un mélange de gaz et d'air inflammable.

- ▶ Installer l'appareil uniquement dans une pièce ayant un volume minimum de 1 m<sup>3</sup> par 8 g de fluide frigorigène. La quantité de fluide frigorigène est indiquée sur la plaque signalétique. → Fig. 1/4

Selon le modèle, le poids de l'appareil départ usine peut atteindre 45 kg. Le plancher doit être assez stable pour supporter le poids de l'appareil.

#### **Température ambiante admissible**

La température ambiante admissible dépend de la classe climatique de l'appareil.

La classe climatique figure sur la plaque signalétique de l'appareil.

→ Fig. 1/4

Classe climatique	Température ambiante admissible
SN	10 °C...32 °C
N	16 °C...32 °C
ST	16 °C...38 °C
T	16 °C...43 °C

L'appareil est entièrement opérationnel dans la plage de température ambiante admissible.

Si vous utilisez un appareil de la classe climatique SN à des températures ambiantes plus basses, il n'est

pas exclu que l'appareil subisse des dommages en présence d'une température ambiante atteignant +5 °C.

### Installation au-dessus et en-dessous, et côte à côte

Si vous souhaitez installer 2 appareils de réfrigération en les superposant ou les plaçant côte à côte, respectez une distance d'au moins 150 mm entre les appareils. Pour certains appareils, une installation sans distance minimale est possible. Demandez conseil à votre revendeur ou à votre cuisiniste.

### 4.3 Monter l'appareil

- ▶ Montez l'appareil selon les instructions de montage jointes.

### 4.4 Préparation de l'appareil pour la première utilisation

1. Retirer le matériel d'informations.
2. Retirer les films protecteurs et les sécurités de transport, par ex. les bandes adhésives et le carton.
3. Nettoyage de l'appareil pour la première fois. → Page 45

### 4.5 Raccordement électrique de l'appareil

1. Branchez la fiche secteur du cordon d'alimentation de l'appareil dans une prise murale à proximité de l'appareil.

Vous trouverez les données de raccordement de l'appareil sur la plaque signalétique. → Fig. 1/4

2. Assurez-vous que la fiche secteur soit correctement branchée.
- ✓ Maintenant, l'appareil est prêt à fonctionner.

---

## 5 Description de l'appareil

### 5.1 Appareil

Cette section contient une vue d'ensemble des composants de votre appareil.

→ Fig. 1

---

1	Bandeau de commande → Page 38
2	Compartiment congélation → Page 42
3	Bacs à fruits et légumes → Page 39
4	Plaque signalétique → Page 51
5	Casier à beurre et à fromage → Page 39
6	Compartiment dans la contre-porte pour grandes bouteilles → Page 39

---

**Remarque :** Selon l'équipement et la taille, des divergences sont possibles entre votre appareil et les illustrations.

### 5.2 Bandeau de commande

Le champ de commande vous permet de configurer toutes les fonctions de votre appareil et vous donne des informations sur l'état de fonctionnement.

→ Fig. 2

---

1	La touche de réglage de température règle la température du compartiment réfrigération.
2	Super s'allume lorsque Super-réfrigération est activé.
3	Affiche la température réglée du compartiment de réfrigération en °C.

---

## 6 Équipement

L'équipement de votre appareil dépend de son modèle.

### 6.1 Clayette

Pour varier la position de la clayette selon les besoins, vous pouvez retirer la clayette et la replacer à un autre endroit.

→ "Retirer la clayette", Page 46

### 6.2 Trappe du compartiment congélation

Sur la clayette derrière la trappe du compartiment congélation, rangez des aliments souvent utilisés ou devant être stockés brièvement.

### 6.3 Bac(s) à fruits et légumes

Conservez les fruits et légumes frais emballés dans le bac à fruits et légumes.

Conservez les fruits et légumes coupés recouverts ou dans un emballage hermétique.

Suivant la quantité et la nature des produits stockés, de l'eau peut se condenser dans le bac à fruits et légumes.

Essuyer l'eau condensée avec un essuie-tout sec.

Afin de conserver leur qualité et leurs arômes, rangez les fruits et légumes sensibles au froid en dehors de l'appareil à des températures comprises entre 8 °C à 12 °C environ, par ex. les ananas, les bananes, les agrumes, les concombres, les courgettes, les poivrons, les tomates et les pommes de terre.

### 6.4 Casier à beurre et à fromage

Rangez le beurre et le fromage à pâte dure dans le casier à beurre et à fromage.

### 6.5 Compartiment dans la contreporte

Pour varier la position du compartiment dans la contreporte selon les besoins, vous pouvez le retirer et le replacer à un autre endroit.

→ "Retirer le compartiment dans la contreporte", Page 46

### 6.6 Accessoires

Utilisez uniquement des accessoires d'origine. Ils ont été spécialement conçus pour votre appareil.

Les accessoires de votre appareil dépendent de son modèle.

#### Bac à œufs

Rangez les œufs sur le bac à œufs.

#### Support-crochet pour bouteilles

Rangez les bouteilles de manière sûre sur le support-crochet pour bouteilles.

→ Fig. 8

#### Bac à glaçons

Utilisez le bac à glaçons, pour confectionner des glaçons.

#### Confectionner des glaçons

Pour préparer des glaçons, utilisez exclusivement de l'eau potable.

1. Remplissez le bac à glaçons aux  $\frac{3}{4}$  avec de l'eau potable et placez-le au congélateur.

Décolliez le bac à glaçons resté collé dans le congélateur uniquement à l'aide d'un instrument émoussé, par ex. un manche de cuillère.

2. Pour enlever les glaçons du bac à glaçons, passez le bac brièvement sous l'eau du robinet ou déformez-le légèrement.

---

## 7 Utilisation

### 7.1 Allumer l'appareil

1. Raccordement électrique de l'appareil. → Page 38

**Remarque :** Si l'appareil a été préalablement éteint à l'aide du bandeau de commande, maintenez la touche <sup>3 sec.</sup> ① enfoncée pendant 3 secondes.

- ✓ L'appareil commence à réfrigérer.
2. Réglez la température souhaitée. → Page 40

### 7.2 Remarques concernant le fonctionnement de l'appareil

- Lorsque vous avez allumé l'appareil, il peut s'écouler jusqu'à plusieurs heures avant que la température réglée ne soit atteinte. Ne rangez aucun aliment avant que la température réglée ne soit atteinte.
- Lorsque vous refermez la porte, une dépression peut se produire. La porte est alors difficile à rouvrir. Patientez quelques instants jusqu'à ce que la dépression soit compensée.

### 7.3 Éteindre l'appareil

- ▶ Appuyez sur <sup>3 sec.</sup> ① pendant 3 secondes.

## 7.4 Régler la température

### Réglage de la température du compartiment réfrigération

- ▶ Appuyer à plusieurs reprises sur la touche de réglage de température jusqu'à ce que l'affichage de la température indique la température souhaitée.

La température recommandée dans le compartiment réfrigération est de 4 °C.

→ "Autocollant « OK »", Page 41

### Régler la température du compartiment congélation

- ▶ Pour régler la température du compartiment congélation, Modifier la température du compartiment réfrigération → Page 40.

La température du compartiment réfrigération influence la température du compartiment congélation. Des températures de compartiment réfrigération plus élevées engendrent des températures de compartiment congélation plus élevées.

---

## 8 Fonctions additionnelles

### 8.1 Super-fonction

Avec la Super-fonction, le compartiment réfrigération et le compartiment congélation réfrigèrent plus fortement.

Activez la Super-fonction 4 à 6 heures avant de ranger une quantité d'aliments à partir de 2 kg.

Pour utiliser la capacité de congélation, utilisez la Super-fonction.

→ "Capacité de congélation", Page 42



**Remarque :** Lorsque la Super-fonction est activée, il est possible que l'appareil fonctionne plus bruyamment.

### Activer Super-fonction

- ▶ Appuyez sur la touche de réglage de température jusqu'à ce que Super s'allume.

**Remarque :** Au bout d'environ 24 heures, l'appareil revient en service normal.

### Désactivez Super-fonction

- ▶ Appuyez sur la touche de réglage de température.

---

## 9 Compartiment réfrigération

Le compartiment réfrigération permet de conserver la viande, la charcuterie, le poisson, les produits laitiers, les œufs, les plats cuisinés et les pâtisseries.

La température est réglable de 2 °C à 8 °C.

Le stockage au froid vous permet aussi de ranger des denrées facilement périssables à court et moyen terme. Plus la température choisie est basse, plus les aliments restent frais plus longtemps.

### 9.1 Conseils pour ranger des produits alimentaires dans le compartiment réfrigération

- Stockez uniquement des aliments frais et intacts.
- Conservez les aliments dans un récipient hermétique ou couvert.

- Pour ne pas entraver la circulation de l'air et pour éviter que les aliments ne gèlent, ne placez pas les aliments directement contre la paroi arrière.
- Laissez les boissons et aliments chauds refroidir avant de les ranger.
- Respectez la date de péremption ou la date limite d'utilisation indiquée par le fabricant.

### 9.2 Zones froides dans le compartiment réfrigération

L'air circulant dans le compartiment réfrigération engendre des zones différemment froides.

#### Zone la plus froide

La zone la plus froide est située entre la flèche imprimée sur le côté et la clayette située en dessous.

**Conseil :** Rangez les aliments périssables dans la zone la plus froide, par ex. le poisson, la charcuterie et la viande.

#### Zone la moins froide

La zone la moins froide se trouve complètement en haut, contre la porte.

**Conseil :** Rangez des produits alimentaires insensibles dans la zone la moins froide, par ex. le fromage à pâte dure et le beurre. Le fromage peut ainsi continuer à développer son arôme, et le beurre reste tartinable.

### 9.3 Autocollant « OK »

L'autocollant « OK » vous permet de vérifier si les plages de températures sûres de + 4 °C ou moins recom-

mandées pour les aliments sont atteintes dans le compartiment réfrigération.

L'autocollant OK n'est pas compris sur tous les modèles.

Si l'autocollant n'indique pas « OK », abaisser progressivement la température.

→ "Réglage de la température du compartiment réfrigération", Page 40

Après la mise en service de l'appareil, ce dernier peut nécessiter jusqu'à 12 heures pour atteindre la température réglée.



Réglage correct

---

## 10 Compartiment congélation

Dans le compartiment congélation, vous pouvez stocker des aliments congelés, congeler des aliments et confectionner des glaçons.

La température dans le compartiment congélation dépend de celle régnant dans le compartiment réfrigération.

La température de stockage à long terme des produits alimentaires doit se situer à  $-18\text{ °C}$  ou encore plus bas.

La congélation vous permet de stocker les aliments facilement périssables à long terme. Les basses températures ralentissent ou stoppent la l'altération des aliments.

### 10.1 Porte du congélateur

Pour que les aliments congelés stockés ne décongèlent pas et que le congélateur ne givre pas aussi fort, fermez toujours la porte du congélateur.

### 10.2 Capacité de congélation

La capacité de congélation indique quelle quantité d'aliments l'appareil peut congeler à cœur en combien d'heures.

Sur la plaque signalétique, vous trouverez des indications concernant la capacité de congélation. → Fig. 1/4

#### Conditions préalables pour la capacité de congélation

1. Lorsque vous rangez des produits alimentaires frais, activez Superfonction.  
→ "Activer Super-fonction", Page 41
2. Faire congeler les produits alimentaires frais à l'arrière, le plus près possible des parois latérales.

### 10.3 Conseils pour ranger des aliments dans le compartiment congélation

- Conservez les aliments dans des emballages hermétiques.
- Veillez à ce que les aliments à congeler n'entrent pas en contact avec d'autres déjà congelés.
- Répartir les produits alimentaires sur toute la surface dans le compartiment congélation.

### 10.4 Conseils pour congeler des aliments frais

- Congelez uniquement des aliments frais et d'un aspect impeccable.

- Congelez les aliments en portions.
- Les plats cuisinés sont plus appropriés que les aliments crus comestibles.
- Lavez, hachez et blanchissez les légumes avant de les congeler.
- Avant la congélation, lavez les fruits, retirez les pépins et épluchez les fruits si nécessaire, ajoutez du sucre ou une solution d'acide ascorbique si nécessaire.
- Les produits de boulangerie, le poisson et les fruits de mer, la viande, le gibier et la volaille, les œufs sans coquille, le fromage, le beurre, le caillé, les plats préparés et les restes se prêtent à la congélation.
- La laitue, les radis, les œufs en coquille, les raisins, les pommes et poires crues, le yaourt, la crème aigre, la crème fraîche et la mayonnaise ne se prêtent pas à la congélation.

### Emballer les surgelés

Un matériau d'emballage approprié et le bon type d'emballage sont essentiels pour maintenir la qualité du produit et éviter les brûlures de congélation.

1. Placez les aliments dans l'emballage.
2. Pressez pour chasser l'air.
3. Fermez hermétiquement l'emballage afin que les aliments ne perdent pas leur saveur ou ne se dessèchent pas.
4. Indiquez sur l'emballage le contenu et la date de congélation.

## 10.5 Durée de conservation du produit congelé à -18 °C

Aliments	Durée de conservation
Poisson, charcuterie, plats cuisinés, pâtisseries	jusqu'à 6 mois
Viande, volaille	jusqu'à 8 mois
Légumes, fruits	jusqu'à 12 mois

## 10.6 Méthodes de décongélation pour aliments congelés



### PRUDENCE

#### Risque de préjudice pour la santé !

Lors de la décongélation, les bactéries peuvent se multiplier et les aliments congelés peuvent s'abîmer.

- ▶ Ne remettez pas à congeler des produits alimentaires partiellement ou entièrement décongelés.
- ▶ Ne recongelez les aliments qu'après avoir les avoir fait cuire ou rôtir.
- ▶ N'utilisez plus la durée de conservation dans son intégralité.
- Décongelez les aliments d'origine animale dans le réfrigérateur, par exemple le poisson, la viande, le fromage et le lait caillé.
- Décongelez le pain à température ambiante.
- Préparez les aliments au micro-ondes, au four ou sur la cuisinière pour une consommation immédiate.

---

## 11 Dégivrage

### 11.1 Dégivrage du compartiment réfrigération

En cours de fonctionnement, des gouttelettes d'eau de condensation ou du givre se forment contre la paroi arrière du réfrigérateur. La paroi arrière du réfrigérateur se dégivre automatiquement.

→ Fig. 4

L'eau de dégivrage s'écoule par la rigole d'écoulement de l'eau de condensation dans le trou d'écoulement pour gagner le bac d'évaporation et ne doit pas être essuyée.

Pour que l'eau de dégivrage puisse s'écouler librement et pour éviter toute apparition d'odeur, respectez les informations suivantes :

→ "Nettoyer la rigole à eau de dégivrage et le trou d'écoulement", Page 45.

### 11.2 Décongélation dans le compartiment congélation

Le compartiment congélation ne décongèle pas automatiquement. Une couche de givre dans le compartiment de congélation empêche le passage du froid vers les aliments congelés et augmente la consommation d'énergie.

#### Dégivrage du compartiment congélation

Dégivrez régulièrement le compartiment congélateur.

1. Env. 4 heures avant le dégivrage, activer la Super-fonction.  
→ "Activer Super-fonction", Page 41

Ce mode amène les produits alimentaires à très basses températures, ce qui vous permet de les stocker plus longtemps à température ambiante.

2. Retirez les aliments congelés et stockez-les dans un endroit frais. Emballez les aliments congelés dans des sacs ou du papier journal avec des accumulateurs de froid, si possible.
3. Éteindre l'appareil. → Page 40
4. Débrancher l'appareil du réseau électrique.  
Débrancher la fiche secteur du cordon d'alimentation secteur ou désactiver le fusible dans le boîtier à fusibles.
5. Pour accélérer le dégivrage, poser dans le compartiment congélation un dessous de plat et une casserole remplie d'eau chaude.
6. Essuyer l'eau de dégivrage avec un chiffon doux ou une éponge.
7. Frotter le compartiment congélateur pour le sécher avec un chiffon sec et doux.
8. Raccordement électrique de l'appareil. → Page 38
9. Ranger des produits congelés.  
→ Page 42

---

## 12 Nettoyage et entretien

Pour que votre appareil reste longtemps opérationnel, nettoyez-le et entretenez-le avec soin.

Le nettoyage de points inaccessibles doit être réalisé par le service après-vente. Le nettoyage par le service après-vente peut engendrer des frais.

### 12.1 Préparer l'appareil pour le nettoyage

1. Éteindre l'appareil. → Page 40

2. Débrancher l'appareil du réseau électrique.  
Débrancher la fiche secteur du cordon d'alimentation secteur ou désactiver le fusible dans le boîtier à fusibles.
3. Retirez tous les aliments de l'appareil et rangez-les dans un endroit frais.  
Si possible, placez des accumulateurs de froid sur les aliments.
4. Si une couche de givre s'est formée, la faire dégivrer.
5. Retirez toutes les pièces d'équipement et les accessoires de l'appareil. → Page 46

## 12.2 Nettoyage de l'appareil

### **AVERTISSEMENT** **Risque d'électrocution !**

L'infiltration d'humidité peut occasionner un choc électrique.

- ▶ Ne pas utiliser de nettoyeur vapeur ou haute pression pour nettoyer l'appareil.

La présence de liquide dans l'éclairage ou dans les éléments de commande peut être dangereuse.

- ▶ L'eau de rinçage ne doit pas pénétrer dans l'éclairage ni dans les éléments de commande.

### **ATTENTION !**

Des produits nettoyants inappropriés peuvent endommager les surfaces de l'appareil.

- ▶ Ne pas utiliser de tampon en paille métallique ni d'éponge à dos récurant.
- ▶ Ne pas utiliser de produits de nettoyage agressifs ou récurants.
- ▶ N'utilisez pas de nettoyants fortement alcoolisés.

Si des liquides pénètrent dans le trou d'écoulement, le bac d'évaporation peut déborder.

- ▶ L'eau de nettoyage ne doit pas pénétrer dans le trou d'écoulement. Si vous nettoyez les pièces d'équipement et les accessoires au lave-vaisselle, ceux-ci risquent de se déformer ou de déteindre.
- ▶ Ne nettoyez jamais les équipements et accessoires au lave-vaisselle.

1. Préparer l'appareil pour le nettoyage. → Page 44
2. Nettoyez l'appareil, les pièces d'équipement, les accessoires et les joints de porte avec une lavette, de l'eau tiède et du produit à vaisselle présentant un pH neutre.
3. Sécher ensuite minutieusement avec un chiffon doux et sec.
4. Insérez les pièces d'équipement.
5. Raccordement électrique de l'appareil. → Page 38
6. Ranger les aliments.

## 12.3 Nettoyer la rigole à eau de dégivrage et le trou d'écoulement

Pour que l'eau de dégivrage puisse s'écouler, nettoyez régulièrement la rigole à eau de dégivrage et le trou d'écoulement.

- ▶ Nettoyer la rigole à eau de dégivrage et le trou d'écoulement avec précaution, par ex. à l'aide d'un coton-tige.  
→ Fig. 5

## 12.4 Retirer les pièces d'équipement

Si vous désirez nettoyer soigneusement les pièces d'équipement, retirez celles-ci de votre appareil.

### Retirer la clayette

- ▶ Soulevez la clayette vers l'avant ①, tirez-la et retirez-la ②.  
→ Fig. 6

### Enlever la trappe du compartiment congélation

- ▶ Ouvrir la trappe du compartiment congélation et la détacher de la fixation.  
→ Fig. 7

### Retirer le compartiment dans la contreporte

- ▶ Soulevez le compartiment dans la contre-porte vers le haut et retirez-le.  
→ Fig. 8

### Retirer le bac à fruits et légumes

1. Extrayez le bac à fruits et légumes jusqu'en butée.
2. Soulevez le bac à fruits et légumes vers l'avant ① et retirez-le ②.  
→ Fig. 9

## 13 Dépannage

Vous pouvez corriger par vous-même les petits défauts de votre appareil. Lisez les renseignements de dépannage avant de contacter le service consommateurs. Vous vous épargnerez ainsi des dépenses inutiles.



### AVERTISSEMENT

#### Risque d'électrocution !

Les réparations non conformes sont dangereuses.

- ▶ Seul un personnel dûment qualifié peut entreprendre des réparations sur l'appareil.
- ▶ Seules des pièces de rechange d'origine peuvent être utilisées pour réparer l'appareil.
- ▶ Afin d'écartier tout danger quand le cordon d'alimentation secteur de cet appareil est endommagé, seul le fabricant ou son service après-vente ou toute autre personne de qualification équivalente est habilité à le remplacer.

Défaut	Cause et dépannage
L'appareil ne réfrigère pas, les affichages et l'éclairage sont allumés.	L'appareil se trouve en mode Exposition. <ul style="list-style-type: none"> <li>▶ Lancez l'auto-test de l'appareil. → <i>Page 49</i></li> <li>✓ Une fois l'auto-test de l'appareil effectué, l'appareil passe en service normal.</li> </ul>
L'éclairage par LED ne fonctionne pas.	Différentes causes sont possibles. <ul style="list-style-type: none"> <li>▶ Appelez le service après-vente.</li> </ul> Vous trouverez le numéro du service après-vente dans les coordonnées des services après-vente dont la liste est jointe.
La température dévie fortement par rapport au réglage.	Différentes causes sont possibles. <ol style="list-style-type: none"> <li>1. Éteignez l'appareil. → <i>Page 40</i></li> <li>2. Allumez à nouveau l'appareil après env. 5 minutes. → <i>Page 40</i> <ul style="list-style-type: none"> <li>– Si la température est trop élevée, vérifiez-la à nouveau au bout de quelques heures.</li> <li>– Si la température est trop basse, vérifiez-la à nouveau le jour suivant.</li> </ul> </li> </ol>
Le fond du compartiment réfrigération est mouillé.	La rigole à eau de dégivrage ou le trou d'écoulement sont bouchés. <ul style="list-style-type: none"> <li>▶ Nettoyez la rigole à eau de dégivrage et le trou d'écoulement. → <i>Page 45</i></li> </ul>
L'appareil vrombit, fait des bulles, des bourdonnements, des gargouillis ou des cliquetis.	Il ne s'agit pas d'un défaut. Un moteur tourne, par ex. groupe frigorifique, ventilateur. Le fluide frigorigène circule dans les tuyaux. Le moteur, les interrupteurs ou les électrovannes s'allument ou s'éteignent. Aucune action nécessaire.

Défaut	Cause et dépannage
L'appareil émet des bruits.	Les pièces d'équipement vacillent ou se coincent. ▶ Vérifiez les pièces d'équipement amovibles et re-mettez-les éventuellement en place correctement.
	Des bouteilles ou récipients se touchent. ▶ Éloigner les bouteilles ou les récipients les uns des autres.
	Super-fonction est activé. Aucune action nécessaire.



## 13.1 Panne de courant

En cas de panne de courant, la température à l'intérieur de l'appareil augmente, ce qui raccourcit la durée de conservation et réduit la qualité des aliments congelés.

Sur notre site Internet dédié à votre appareil, vous trouverez dans les caractéristiques techniques la durée de conservation des aliments congelés en cas de dysfonctionnement.

### Remarques

- Ouvrez l'appareil le moins possible en cas de panne de courant et ne stockez pas d'autres aliments.
- Vérifiez la qualité des aliments immédiatement après la panne de courant.
  - Jetez les aliments congelés qui sont décongelés et dont la température est supérieure à 5 °C.
  - Faites bouillir ou frire des aliments congelés légèrement décongelés et consommez-les ou recongelez-les.

## 13.2 Effectuer l'auto-test de l'appareil

1. Éteindre l'appareil. → *Page 40*
  2. Débrancher l'appareil du réseau électrique.  
Débrancher la fiche secteur du cordon d'alimentation secteur ou désactiver le fusible dans le boîtier à fusibles.
  3. Raccordez l'appareil à l'alimentation électrique après 5 minutes.  
→ *Page 38*
  4. Dans les 10 secondes qui suivent la mise sous tension, maintenez enfoncé la touche de réglage de température pendant 5 à 7 secondes, jusqu'à ce qu'un deuxième signal sonore retentisse.
- ✓ L'auto-test de l'appareil démarre.

- ✓ Au cours de l'auto-test, un signal sonore long retentit par intermittence.
- ✓ Si, à la fin de l'auto-test, 2 signaux sonores retentissent et que *Super* clignote deux fois, cela signifie que votre appareil fonctionne correctement. L'appareil revient en service normal.
- ✓ Si, à la fin de l'auto-test, 5 signaux sonores retentissent et si *Super* clignote pendant 10 secondes, informer le service après-vente.

---

## 14 Entreposage et élimination

Découvrez ici comment préparer votre appareil pour le stockage. Découvrez également comment éliminer les appareils usagés.

### 14.1 Mise hors service de l'appareil

1. Éteindre l'appareil. → *Page 40*
2. Débrancher l'appareil du réseau électrique.  
Débrancher la fiche secteur du cordon d'alimentation secteur ou désactiver le fusible dans le boîtier à fusibles.
3. Retirez tous les aliments.
4. Dégivrer l'appareil. → *Page 44*
5. Nettoyer l'appareil. → *Page 45*
6. Afin de garantir la ventilation de l'espace intérieur, laissez l'appareil ouvert.

## 14.2 Mettre au rebut un appareil usagé

La destruction dans le respect de l'environnement permet de récupérer de précieuses matières premières.

### AVERTISSEMENT

#### Risque de préjudice pour la santé !

Des enfants risquent de s'enfermer dans l'appareil et de mettre leur vie en danger.

- ▶ Pour compliquer la pénétration des enfants dans l'appareil, ne pas retirer les clayettes et les bacs.
- ▶ Éloigner les enfants de l'appareil qui a cessé de servir.

### AVERTISSEMENT

#### Risque d'incendie !

En cas d'endommagement des tuyaux, du fluide frigorigène inflammable et des gaz nocifs peuvent s'échapper et s'enflammer.

- ▶ Veillez à ne pas endommager les tubulures du circuit frigorifique, ni l'isolant.
1. Débrancher la fiche du cordon d'alimentation secteur.
  2. Couper le cordon d'alimentation secteur.
  3. Éliminez l'appareil dans le respect de l'environnement.
- Vous trouverez des informations sur les circuits actuels d'élimination auprès de votre revendeur spécialisé ou de l'administration de votre commune/ville.



Cet appareil est marqué selon la directive européenne 2012/19/UE relative aux appareils électriques et électroniques

usagés (waste electrical and electronic equipment - WEEE).

La directive définit le cadre pour une reprise et une récupération des appareils usagés applicables dans les pays de la CE.

---

## 15 Service après-vente

Contactez notre service après-vente si vous avez des questions, si vous n'arrivez pas à corriger un défaut de l'appareil ou si ce dernier doit être réparé.

Les pièces de rechange relatives au fonctionnement de l'appareil et conformes à l'ordonnance d'écoconception correspondante sont disponibles auprès de notre service après-vente pour une durée d'au moins 10 ans à partir de la mise sur le marché de votre appareil dans l'Espace économique européen.

**Remarque :** L'intervention du service après-vente est gratuite dans le cadre de la garantie locale du fabricant en vigueur. La durée minimale de la garantie (garantie du fabricant pour consommateurs privés) dans l'Espace économique européen est de 2 ans selon les conditions de garantie locales en vigueur. Les conditions de garantie n'ont aucune incidence sur les autres droits ou recours qui vous sont disponibles en vertu du droit local.

Pour plus d'informations sur la durée et les conditions de la garantie dans votre pays, adressez-vous à notre service après-vente, à votre revendeur ou consultez notre site Web.

Lorsque vous contactez le service après-vente, vous avez besoin du numéro de produit (E-Nr.) et du numéro de fabrication (FD) de votre appareil. Vous trouverez les données de contact du service après-vente dans la liste ci-jointe ou sur notre site Web.

### **15.1 Numéro de produit (E-Nr) et numéro de fabrication (FD)**

Le numéro de série (E-Nr.) et le numéro de fabrication (FD) sont indiqués sur la plaque signalétique de l'appareil.

→ Fig. **1**/ **4**

Pour retrouver rapidement les données de votre appareil et le numéro de téléphone du service consommateurs, n'hésitez pas à les recopier ailleurs.

L'identifiant du modèle se base sur les caractères précédant la barre oblique dans le numéro de produit (E-Nr.) sur la plaque signalétique. Vous pouvez également trouver l'identifiant du modèle sur la première ligne du label énergétique de l'UE.

---

## **16 Caractéristiques techniques**

La plaque signalétique mentionne le fluide frigorigène, le volume net ainsi que d'autres données techniques.

→ Fig. **1**/ **4**

Ce produit contient une source de lumière de la classe d'efficacité énergétique E. La source de lumière est disponible en tant que pièce de rechange et doit être remplacée uniquement par du personnel qualifié. Vous trouverez de plus amples informations sur votre modèle sur Internet à l'adresse

<https://eprel.ec.europa.eu/><sup>1</sup>. Cette adresse Internet renvoie à la base de données officielle des produits de l'UE, EPREL. Veuillez suivre les instructions de la recherche de modèle.

---

<sup>1</sup> Valable uniquement pour les pays de l'espace économique européen

# Indice

<b>1 Sicurezza .....</b>	<b>54</b>		
1.1 Avvertenze generali.....	54	7.2 Istruzioni per il funzionamen-	
1.2 Utilizzo conforme all'uso pre-		to .....	64
visto .....	54	7.3 Spegnimento dell'apparec-	
1.3 Limitazione di utilizzo.....	54	chio.....	64
1.4 Trasporto sicuro .....	54	7.4 Regolazione della tempera-	
1.5 Installazione sicura.....	55	tura .....	64
1.6 Utilizzo sicuro .....	56	<b>8 Funzioni supplementari.....</b>	<b>64</b>
1.7 Apparecchio danneggiato.....	58	8.1 Funzione «super» .....	64
<b>2 Prevenzione di danni materia-</b>		<b>9 Frigorifero.....</b>	<b>65</b>
<b>li.....</b>	<b>60</b>	9.1 Consigli per la conservazio-	
<b>3 Tutela dell'ambiente e rispar-</b>		ne degli alimenti nel frigorife-	
<b>mio .....</b>	<b>60</b>	ro .....	65
3.1 Smaltimento dell'imballaggio ...	60	9.2 Zone fredde nel frigorifero .....	65
3.2 Risparmio energetico .....	60	9.3 Adesivo OK .....	65
<b>4 Installazione e allacciamento ....</b>	<b>61</b>	<b>10 Congelatore .....</b>	<b>66</b>
4.1 Contenuto della confezione .....	61	10.1 Porta del congelatore.....	66
4.2 Criteri per il luogo d'installa-		10.2 Capacità di congelamento .....	66
zione .....	61	10.3 Consigli per la conservazio-	
4.3 Montaggio dell'apparecchio.....	62	ne di alimenti nel vano con-	
4.4 Preparazione dell'apparec-		gelatore .....	66
chio per il primo utilizzo .....	62	10.4 Consigli per congelare ali-	
4.5 Collegamento elettrico		menti freschi.....	66
dell'apparecchio .....	62	10.5 Conservazione degli ali-	
<b>5 Conoscere l'apparecchio.....</b>	<b>62</b>	menti congelati a -18 °C.....	67
5.1 Apparecchio .....	62	10.6 Metodi di scongelamento	
5.2 Pannello di comando .....	62	per alimenti congelati.....	67
<b>6 Dotazione.....</b>	<b>63</b>	<b>11 Scongelamento .....</b>	<b>67</b>
6.1 Ripiano .....	63	11.1 Scongelamento nel frigori-	
6.2 Sportello del congelatore.....	63	fero .....	67
6.3 Contenitore per frutta e ver-		11.2 Scongelamento nel vano	
dura .....	63	congelatore .....	67
6.4 Comparto per burro e for-		<b>12 Pulizia e cura.....</b>	<b>68</b>
maggio .....	63	12.1 Preparazione dell'apparec-	
6.5 Balconcino controporta.....	63	chio per la pulizia .....	68
6.6 Accessori.....	63	12.2 Pulizia dell'apparecchio.....	68
<b>7 Comandi di base .....</b>	<b>64</b>	12.3 Pulizia del convogliatore	
7.1 Accensione dell'apparecchio... 64		dell'acqua di sbrinamento e	
		del foro di scarico .....	69
		12.4 Rimozione degli accessori.....	69

<b>13 Sistemazione guasti.....</b>	<b>70</b>
13.1 Interruzione dell'alimenta- zione elettrica .....	72
13.2 Esecuzione dell'autotest dell'apparecchio .....	72
<b>14 Stoccaggio e smaltimento .....</b>	<b>72</b>
14.1 Messa fuori servizio dell'ap- parecchio.....	72
14.2 Rottamazione di un appa- recchio dismesso .....	73
<b>15 Servizio di assistenza clienti... 73</b>	
15.1 Codice prodotto (E-Nr.) e codice di produzione (FD) .....	74
<b>16 Dati tecnici.....</b>	<b>74</b>



## 1 Sicurezza

Osservare le seguenti avvertenze di sicurezza.

### 1.1 Avvertenze generali

- Leggere attentamente le presenti istruzioni.
- Conservare le istruzioni e le informazioni sul prodotto per il successivo utilizzo o per il futuro proprietario.
- Non collegare l'apparecchio se ha subito danni durante il trasporto.

### 1.2 Utilizzo conforme all'uso previsto

Questo apparecchio è concepito esclusivamente per l'incasso. Utilizzare l'apparecchio soltanto:

- Per refrigerare e per congelare gli alimenti e per la produzione di ghiaccio.
- in case private e in locali chiusi in ambito domestico;
- fino a un'altitudine di massimo 2000 m sul livello del mare.

### 1.3 Limitazione di utilizzo

Questo apparecchio può essere utilizzato da bambini di età pari o superiore a 8 anni e da persone con ridotte facoltà fisiche, sensoriali o mentali o prive di sufficiente esperienza e/o conoscenza se sorvegliati o già istruiti in merito all'utilizzo sicuro dell'apparecchio e se hanno compreso i rischi da esso derivanti.

I bambini non devono giocare con l'apparecchio.

Ai bambini senza sorveglianza è vietato eseguire la pulizia e manutenzione di competenza dell'utente.

I bambini da 3 a 8 anni possono caricare e scaricare il frigorifero/ congelatore.

### 1.4 Trasporto sicuro

#### **AVVERTENZA – Pericolo di lesioni!**

Il peso elevato dell'apparecchio può causare lesione durante il sollevamento.

- ▶ Non sollevare l'apparecchio autonomamente.

## 1.5 Installazione sicura

### **⚠ AVVERTENZA – Pericolo di scosse elettriche!**

Le installazioni effettuate in modo non appropriato costituiscono un pericolo.

- ▶ Collegare e utilizzare l'apparecchio solo in conformità con i dati indicati sulla targhetta identificativa.
- ▶ Collegare l'apparecchio a una rete a corrente alternata soltanto con una presa con messa a terra installata a norma.
- ▶ Il sistema del conduttore di protezione dell'impianto elettrico domestico deve essere installato a norma.
- ▶ Non alimentare mai l'apparecchio da un commutatore esterno ad es. un timer esterno o un telecomando.
- ▶ Se l'apparecchio è incassato, la spina di alimentazione del cavo di collegamento alla rete elettrica deve essere liberamente accessibile, oppure qualora non fosse possibile accedere liberamente alla spina, nell'impianto elettrico fisso deve essere montato un dispositivo di separazione onnipolare conformemente alle norme di installazione.
- ▶ Durante l'installazione dell'apparecchio prestare attenzione che il cavo di alimentazione non resti incastrato e non si danneggi.

Un isolamento danneggiato del cavo di allacciamento alla rete costituisce un pericolo.

- ▶ Non mettere mai il cavo di allacciamento alla rete a contatto con fonti di calore.

### **⚠ AVVERTENZA – Pericolo di esplosione!**

Se le aperture di ventilazione dell'apparecchio sono tappate, in caso di perdita del circuito refrigerante si può creare una miscela infiammabile di gas e aria.

- ▶ Nonappare le aperture di ventilazione all'interno dell'alloggiamento dell'apparecchio o nell'alloggiamento a incasso.

### **⚠ AVVERTENZA – Pericolo di incendio!**

È pericoloso utilizzare un cavo di alimentazione con una prolunga e un adattatore non ammesso.

- ▶ Non utilizzare cavi di prolunga o prese multiple.

- ▶ Se il cavo di alimentazione è troppo corto, contattare il servizio di assistenza clienti.
- ▶ Utilizzare esclusivamente gli adattatori approvati dal produttore. Le prese multiple mobili o gli alimentatori mobili possono surriscaldarsi e provocare un incendio.
- ▶ Non collocare prese multiple mobili o alimentatori mobili nella parte posteriore dell'apparecchio.

## 1.6 Utilizzo sicuro

### **⚠ AVVERTENZA – Pericolo di scosse elettriche!**

L'infiltrazione di umidità può provocare una scarica elettrica.

- ▶ Utilizzare l'apparecchio esclusivamente in luoghi chiusi.
- ▶ Non esporre mai l'apparecchio a calore e umidità eccessivi.
- ▶ Non lavare l'apparecchio con pulitori a vapore o idropulitrici.

### **⚠ AVVERTENZA – Pericolo di soffocamento!**

I bambini potrebbero mettersi in testa il materiale di imballaggio o avvolgersi nello stesso, rimanendo soffocati.

- ▶ Tenere lontano il materiale di imballaggio dai bambini.
- ▶ Vietare ai bambini di giocare con materiali d'imballaggio.

I bambini possono inspirare o ingoiare le parti piccole, rimanendo soffocati.

- ▶ Tenere i bambini lontano dalle parti piccole.
- ▶ Non lasciare che i bambini giochino con le parti piccole.

### **⚠ AVVERTENZA – Pericolo di esplosione!**

Se il circuito refrigerante è danneggiato, può fuoriuscire del refrigerante infiammabile ed esplodere.

- ▶ Per accelerare il processo di scongelamento non utilizzare dispositivi meccanici o altri strumenti diversi da quelli consigliati dal produttore.
- ▶ Staccare gli alimenti congelati con un oggetto smussato, ad es. il manico di un cucchiaio di legno.

I prodotti contenenti gas propellenti combustibili e sostanze esplosive possono esplodere, per es. bombolette spray.

- ▶ Non conservare nell'apparecchio prodotti contenenti gas propellenti combustibili e sostanze esplosive.



**⚠ AVVERTENZA – Pericolo di incendio!**

Gli apparecchi elettrici all'interno di questo elettrodomestico possono incendiarsi, ad esempio apparecchi di riscaldamento o produttori di ghiaccio elettrici.

- ▶ Non utilizzare alcun apparecchio elettrico all'interno dell'elettrodomestico.

**⚠ AVVERTENZA – Pericolo di lesioni!**

I contenitori di bevande contenenti anidride carbonica possono esplodere.

- ▶ Non conservare nel congelatore contenitori con bevande contenenti anidride carbonica.

Pericolo di lesioni agli occhi dovute alla fuoriuscita di refrigerante infiammabile e gas nocivi.

- ▶ Non danneggiare i tubi del circuito refrigerante e l'isolamento.

**⚠ AVVERTENZA – Pericolo di ustioni da freddo!**

Il contatto con gli alimenti surgelati e le superfici fredde può causare bruciature dovute al freddo.

- ▶ Non mettere in bocca alimenti congelati appena presi dal congelatore.
- ▶ Evitare il contatto prolungato della pelle con prodotti surgelati, ghiaccio e con superfici nel congelatore.

**⚠ ATTENZIONE – Pericolo di danni alla salute!**

Osservare le seguenti indicazioni per evitare di sporcare gli alimenti.

- ▶ Se la porta viene aperta per un periodo di tempo prolungato, si può verificare un notevole aumento di temperatura all'interno degli scomparti dell'apparecchio.
- ▶ Pulire regolarmente le superfici che entrano in contatto con gli alimenti e i sistemi di scarico accessibili.
- ▶ Conservare carne e pesce crudi in contenitori adatti nel frigorifero, in modo che non entrino in contatto con altri alimenti o non gocciolino su questi.

- ▶ Se il frigorifero/congelatore rimane vuoto per un lungo periodo, spegnere l'apparecchio, scongelarlo, pulirlo e lasciare aperta la porta per prevenire la formazione di muffa.

I componenti nell'apparecchio in metallo o che sembrano in metallo possono contenere alluminio. Se cibi con un certo grado di acidità entrano in contatto con l'alluminio, gli ioni di alluminio possono trasferirsi negli alimenti.

- ▶ Non consumare alimenti contaminati.

## 1.7 Apparecchio danneggiato

### **⚠ AVVERTENZA – Pericolo di scosse elettriche!**

Un apparecchio o un cavo di alimentazione danneggiati costituiscono un pericolo.

- ▶ Non mettere mai in funzione un apparecchio danneggiato.
- ▶ Non tirare mai il cavo di collegamento alla rete elettrica per staccare l'apparecchio dalla rete elettrica. Staccare sempre la spina del cavo di alimentazione.
- ▶ Se l'apparecchio o il cavo di alimentazione è danneggiato, staccare subito la spina di alimentazione del cavo di alimentazione e spegnere il fusibile nella scatola dei fusibili.
- ▶ Rivolgersi al servizio di assistenza clienti. → *Pagina 73*

Gli interventi di riparazione effettuati in modo non appropriato rappresentano una fonte di pericolo.

- ▶ Solo il personale adeguatamente specializzato e formato può eseguire riparazioni sull'apparecchio.
- ▶ Per la riparazione dell'apparecchio possono essere impiegati soltanto pezzi di ricambio originali.
- ▶ Al fine di evitare pericoli, se il cavo di alimentazione di questo apparecchio subisce danni deve essere sostituito dal produttore, dal suo servizio di assistenza clienti o da persona in possesso di simile qualifica.

**⚠ AVVERTENZA – Pericolo di incendio!**

In caso di danneggiamento dei tubi, il refrigerante infiammabile e i gas nocivi possono fuoriuscire e prendere fuoco.

- ▶ Tenere il fuoco e le fonti di calore lontani dall'apparecchio.
- ▶ Ventilare l'ambiente.
- ▶ Spegnere l'apparecchio. → *Pagina 64*
- ▶ Togliere la spina del cavo di alimentazione o disattivare il fusibile nella scatola dei fusibili.
- ▶ Rivolgersi al servizio di assistenza clienti. → *Pagina 73*

---

## 2 Prevenzione di danni materiali

### ATTENZIONE!

Salendo o sedendosi sullo zoccolo, sugli elementi estraibili o sulle porte, l'apparecchio può danneggiarsi.

- ▶ Non salire su zoccolo, parti estraibili o porte, né sostenersi sugli stessi.

Le parti di plastica e le guarnizioni delle porte possono diventare porose a causa di sporco di olio o grasso.

- ▶ Tenere le parti in materiale plastico e le guarnizioni delle porte sempre libere da olio e grasso.

I componenti nell'apparecchio in metallo o che sembrano in metallo possono contenere alluminio. L'alluminio ha una reazione chimica se è a contatto con cibi con un certo grado di acidità.

- ▶ Non mettere alimenti nell'apparecchio senza imballaggio.

---

## 3 Tutela dell'ambiente e risparmio

### 3.1 Smaltimento dell'imballaggio

I materiali dell'imballaggio sono rispettosi dell'ambiente e possono essere riutilizzati.

- ▶ Smaltire le singole parti distintamente secondo il tipo di materiale.

### 3.2 Risparmio energetico

Osservando queste avvertenze l'apparecchio consuma meno energia elettrica.

#### Selezione del luogo d'installazione

- Proteggere l'apparecchio dalla luce diretta del sole.
- Disporre l'apparecchio alla maggiore distanza possibile da radiatori, piano cottura e altre fonti di calore:
  - Mantenere una distanza di 30 mm dai fornelli elettrici o a gas.
  - Mantenere una distanza di 300 mm da stufe a olio o a carbone.
- Non coprire oppure ostruire mai le aperture di ventilazione esterne.

#### Risparmio energetico durante l'utilizzo

**Nota:** La disposizione delle parti dell'attrezzatura non influisce sul consumo di energia dell'apparecchio.

- Aprire solo per poco l'apparecchio e richiuderlo accuratamente.
- Non coprire né bloccare mai le aperture di aerazione interne e le aperture di ventilazione esterne.
- Trasportare gli alimenti acquistati in una borsa termica e metterli subito nell'apparecchio.
- Lasciare raffreddare gli alimenti e le bevande, se caldi, prima di collocarli nell'apparecchio.
- Per scongelare gli alimenti surgelati metterli nel frigorifero, in modo da sfruttare il freddo che hanno accumulato.
- Lasciare sempre un poco di spazio fra gli alimenti e la parete posteriore.
- Sbrinare regolarmente il congelatore.

- Aprire solo per poco il congelatore e richiuderlo accuratamente.

## 4 Installazione e allacciamento

### 4.1 Contenuto della confezione

Dopo il disimballaggio controllare che ci siano tutti i componenti e che non presentino danni dovuti al trasporto.

In caso di contestazioni rivolgersi al fornitore oppure al nostro servizio di assistenza clienti → *Pagina 73*.

La dotazione comprende:

- Apparecchio da incasso
- Attrezzatura e accessori<sup>1</sup>
- Materiale di montaggio
- Istruzioni per il montaggio
- Istruzioni per l'uso
- Elenco dei centri di assistenza clienti
- Allegato di garanzia convenzionale<sup>2</sup>
- Etichetta energetica
- Informazioni sul consumo energetico e sui possibili rumori

### 4.2 Criteri per il luogo d'installazione

#### AVVERTENZA

##### Pericolo di esplosione!

Se l'apparecchio è collocato in un locale troppo piccolo, in caso di perdita del circuito refrigerante si può creare una miscela infiammabile di gas e aria.

- ▶ Collocare l'apparecchio soltanto in un locale con un volume minimo di 1 m<sup>3</sup> ogni 8 g di refrigerante. La quantità di refrigerante è indicata sulla targhetta identificativa. → *Fig. 1/4*

A seconda del modello l'apparecchio può pesare di fabbrica fino a 45 kg. Per poter trasportare il peso dell'apparecchio, la base deve essere sufficientemente stabile.

#### Temperatura ambiente ammessa

La temperatura ambiente ammessa dipende dalla classe climatica dell'apparecchio.

La classe climatica è indicata nella targhetta identificativa. → *Fig. 1/4*

Classe climatica	Temperatura ambiente ammessa
SN	10 °C...32 °C
N	16 °C...32 °C
ST	16 °C...38 °C
T	16 °C...43 °C

Nei limiti della temperatura ambiente ammessa l'apparecchio è pienamente efficiente.

Se un apparecchio della classe climatica SN viene utilizzato a temperature ambiente inferiori, possono esse-

<sup>1</sup> In funzione dell'allestimento dell'apparecchio

<sup>2</sup> Non in tutti i Paesi

re esclusi danni all'apparecchio fino ad una temperatura ambiente di 5 °C.

### Installazione over-and-under e side-by-side

Se si desiderano installare due apparecchi di refrigerazione sovrapposti o vicini, mantenere una distanza di almeno 150 mm l'uno dall'altro. Per apparecchi selezionati è possibile eseguire un'installazione senza distanza minima. A tal proposito, rivolgersi al proprio rivenditore specializzato o progettista della cucina.

### 4.3 Montaggio dell'apparecchio

- ▶ Montare l'apparecchio secondo le relative istruzioni di montaggio.

### 4.4 Preparazione dell'apparecchio per il primo utilizzo

1. Rimuovere il materiale informativo.
2. Rimuovere la pellicola protettiva e i blocchi di trasporto, come il nastro adesivo e il cartone.
3. Pulire l'apparecchio per la prima volta. → *Pagina 68*

### 4.5 Collegamento elettrico dell'apparecchio

1. Inserire la spina del cavo di allacciamento alla rete dell'apparecchio a una presa vicina.

I dati di collegamento dell'apparecchio sono indicati sulla targhetta di identificazione. → *Fig. 1/4*

2. Controllare il corretto posizionamento della spina.
- ✓ Ora l'apparecchio è pronto per il funzionamento.

## 5 Conoscere l'apparecchio

### 5.1 Apparecchio

Di seguito è riportata una panoramica dei componenti dell'apparecchio. → *Fig. 1*

- 
- |          |  |
|----------|--|
| <b>1</b> | Pannello di comando<br>→ <i>Pagina 62</i>                |
| <b>2</b> | Congelatore → <i>Pagina 66</i>                           |
| <b>3</b> | Contenitore per frutta e verdura → <i>Pagina 63</i>      |
| <b>4</b> | Targhetta identificativa<br>→ <i>Pagina 74</i>           |
| <b>5</b> | Scomparto per burro e formaggio → <i>Pagina 63</i>       |
| <b>6</b> | Balconcino porta per grandi bottiglie → <i>Pagina 63</i> |
- 

**Nota:** A seconda della dotazione e delle dimensioni sono possibili differenze fra apparecchio e figure.

### 5.2 Pannello di comando

Il pannello di comando consente di impostare tutte le funzioni dell'apparecchio e di ottenere informazioni sullo stato di esercizio.

→ *Fig. 2*

- 
- |          |  |
|----------|--|
| <b>1</b> | Il pulsante di regolazione della temperatura imposta la temperatura del frigorifero. |
| <b>2</b> | Super si accende quando Super-raffreddamento è attiva.                               |
| <b>3</b> | Indica in °C la temperatura impostata del frigorifero.                               |
-

## 6 Dotazione

La dotazione dell'apparecchio dipende dal modello.

### 6.1 Ripiano

Per variare il ripiano secondo la necessità, rimuoverlo e reinserirlo in un altro punto.

→ *"Rimozione del ripiano", Pagina 69*

### 6.2 Sportello del congelatore

Sul ripiano dietro lo sportello del congelatore riporre alimenti utilizzati spesso oppure quelli da conservare per un breve periodo.

### 6.3 Contenitore per frutta e verdura

Conservare frutta e verdura fresche coprendole nell'apposito cassetto. La frutta e la verdura già tagliate devono essere conservate coperte o sigillate ermeticamente.

A seconda della quantità e del prodotto conservato, nel cassetto per frutta e verdura può formarsi condensa.

Rimuovere la condensa con un panno asciutto.

Per mantenere la qualità e l'aroma, conservare frutta e verdura sensibili al freddo all'esterno dell'apparecchio a temperature tra 8 °C e 12 °C, ad es. ananas, banane, agrumi, cetrioli, zucchine, peperoni, pomodori e patate.

### 6.4 Scomparto per burro e formaggio

Conservare il burro e il formaggio duro nei relativi scomparti.

### 6.5 Balconcino controporta

Per variare il balconcino controporta, è possibile rimuoverlo e reinserirlo in un altro punto.

→ *"Rimozione del balconcino controporta", Pagina 69*

### 6.6 Accessori

Utilizzare gli accessori originali in quanto prodotti appositamente per questo apparecchio.

Gli accessori dipendono dal modello di apparecchio.

#### Portauova

Conservare le uova nel portauova.

#### Portabottiglie

Disporre in sicurezza le bottiglie sul portabottiglie.

→ *Fig. 8*

#### Vaschetta per cubetti di ghiaccio

Per fare i cubetti di ghiaccio, utilizzare la vaschetta apposita.

#### Produzione di cubetti di ghiaccio

Per produrre cubetti di ghiaccio utilizzare esclusivamente acqua potabile.

1. Riempire la vaschetta per cubetti di ghiaccio per  $\frac{3}{4}$  con acqua potabile e inserirla nel congelatore.

Staccare la vaschetta eventualmente attaccata solo con un oggetto non acuminato, ad esempio un manico di cucchiaio.

2. Per staccare i cubetti di ghiaccio mettere brevemente la vaschetta sotto acqua corrente oppure torcerla leggermente.

---

## 7 Comandi di base

### 7.1 Accensione dell'apparecchio

1. Collegare elettricamente l'apparecchio. → *Pagina 62*

**Nota:** Se l'apparecchio è stato precedentemente spento con il pannello di comando, tenere premuto <sup>3 sec.</sup> ① per 3 secondi.

- ✓ L'apparecchio inizia a raffreddare.
2. Impostare la temperatura desiderata. → *Pagina 64*

### 7.2 Istruzioni per il funzionamento

- Una volta acceso, l'apparecchio può impiegare anche diverse ore per raggiungere la temperatura impostata.  
Non inserire alcuna pietanza prima che venga raggiunta la temperatura impostata.
- Chiudendo lo sportello, si può verificare una depressione. Lo sportello si riapre solo con difficoltà. Attendere brevemente finché la depressione non è stata compensata.

### 7.3 Spegnimento dell'apparecchio

- ▶ Tenere premuto <sup>3 sec.</sup> ① per 3 secondi.

## 7.4 Regolazione della temperatura

### Regolazione della temperatura del frigorifero

- ▶ Premere ripetutamente il pulsante di regolazione della temperatura finché l'indicatore non indica la temperatura desiderata.

La temperatura consigliata all'interno del frigorifero è di 4 °C.

→ *"Adesivo OK", Pagina 65*

### Regolazione della temperatura del congelatore

- ▶ Per regolare la temperatura del congelatore, modificare la temperatura del frigorifero → *Pagina 64*.  
La temperatura del frigorifero influisce su quella del congelatore.  
Temperature alte del frigorifero generano temperature alte nel congelatore.

---

## 8 Funzioni supplementari

### 8.1 Funzione «super»

Con il Funzione «super» il frigorifero e il congelatore raffreddano di più. Attivare la Funzione «super» da 4 a 6 ore prima di conservare una quantità di alimenti a partire da 2 kg. Per sfruttare la capacità di congelamento, utilizzare Funzione «super». → *"Capacità di congelamento", Pagina 66*

**Nota:** Con il Funzione «super» attivato, il rumore dell'apparecchio potrebbe aumentare.



### Attivare Funzione «super»

- ▶ Premere ripetutamente il pulsante di regolazione della temperatura finché Super non si accende.

**Nota:** Dopo 24 ore l'apparecchio commuta al funzionamento normale.

### Disattivare Funzione «super»

- ▶ Premere il pulsante di regolazione della temperatura.

---

## 9 Frigorifero

Nel frigorifero è possibile conservare carne, salsiccia, pesce, latticini, uova, piatti cucinati e prodotti da forno. La temperatura può essere regolata da 2 °C a 8 °C.

Mediante conservazione in frigorifero anche alimenti facilmente deperibili possono essere conservati a breve o medio termine. Minore è la temperatura selezionata, più a lungo rimangono freschi gli alimenti.

### 9.1 Consigli per la conservazione degli alimenti nel frigorifero

- Conservare soltanto alimenti freschi e integri.
- Sistemare gli alimenti confezionati o coperti in modo sigillato.
- Per non compromettere la circolazione dell'aria ed evitare che gli alimenti congelino, non posizionare questi ultimi direttamente davanti alla parete posteriore.
- Fare prima raffreddare gli alimenti e le bevande caldi.
- Osservare la data minima di conservazione o la data di consumo indicata dal produttore.

### 9.2 Zone fredde nel frigorifero

Per via della circolazione dell'aria all'interno del frigo si creano diverse zone fredde.

#### Zona più fredda

La zona più fredda si trova fra la freccia impressa lateralmente e il sottostante ripiano.

**Consiglio:** Conservare nella zona più fredda gli alimenti facilmente deperibili, per esempio pesce, salsiccia, carne.

#### Zona meno fredda

La zona meno fredda è nella parte più alta della porta.

**Consiglio:** Conservare gli alimenti meno delicati nella zona meno fredda, ad es. formaggio duro e burro. Il formaggio può così continuare a diffondere il suo aroma e il burro resta spalmabile.

### 9.3 Adesivo OK

Con l'adesivo OK è possibile controllare se nel frigorifero sono stati raggiunti i range di temperatura sicuri consigliati per gli alimenti di +4 °C o di temperatura inferiore.

L'adesivo OK non è compreso nella fornitura di tutti i modelli.

Se l'adesivo non indica OK, ridurre progressivamente la temperatura.

→ *"Regolazione della temperatura del frigorifero", Pagina 64*

Dopo la messa in funzione dell'apparecchio possono passare fino a 12 ore prima che sia raggiunta la temperatura impostata.



Corretta regolazione

## 10 Congelatore

Nel vano congelatore è possibile conservare i prodotti surgelati, congelare gli alimenti e produrre i cubetti di ghiaccio.

La temperatura del congelatore dipende dalla temperatura del frigorifero.

La conservazione a lungo termine degli alimenti va eseguita a  $-18\text{ }^{\circ}\text{C}$  o a temperature più basse.

Mediante conservazione in congelatore anche alimenti deperibili possono essere conservati a lungo termine. Le basse temperature rallentano oppure arrestano il deterioramento.

### 10.1 Porta del congelatore

Chiudere sempre la porta del congelatore, affinché gli alimenti surgelati non si scongelino e non si formi più ghiaccio nel vano.

### 10.2 Capacità di congelamento

La capacità di congelamento indica in quante ore può essere completamente congelata una determinata quantità di alimenti.

Sulla targhetta identificativa sono riportati i dati della capacità di congelamento. → Fig. 1/4

#### Condizioni per la capacità di congelamento

1. Mentre si introducono gli alimenti freschi, accendere Funzione «super».  
→ "Attivare Funzione «super»",  
Pagina 65
2. Congelare gli alimenti freschi possibilmente dietro, vicino alle pareti laterali.

### 10.3 Consigli per la conservazione di alimenti nel vano congelatore

- Sistemare gli alimenti confezionati o coperti in modo sigillato.
- Non mettere gli alimenti da surgelare a contatto con gli alimenti surgelati.
- Distribuire in modo esteso gli alimenti nel congelatore.

### 10.4 Consigli per congelare alimenti freschi

- Congelare soltanto alimenti freschi e integri.
- Congelare alimenti in porzioni.
- Gli alimenti da cuocere sono più adeguati rispetto a quelli da consumare crudi.
- Lavare, sminuzzare e sbollentare la verdura prima di congelarla.
- Lavare, snocciolare ed eventualmente sbucciare la frutta prima di congelarla, aggiungere eventualmente zucchero o una soluzione di acido ascorbico.
- Alimenti adatti al congelamento sono ad es. prodotti da forno, pesce e frutti di mare, carne, selvaggina e pollame, uova senza guscio, formaggio, burro, quark, cibi pronti e i residui di alimenti.
- Alimenti non adatti al congelamento sono ad es. lattuga, ravanelli, uova con guscio, uva, mele e pere crude, yogurt, panna acida, crème fraîche e maionese.

#### Confezionamento di alimenti surgelati

Il materiale di confezionamento adeguato e la tipologia corretta di imballaggio mantengono la qualità del prodotto ed evitano bruciature da freddo.

1. Introdurre l'alimento nella confezione.
2. Fare uscire l'aria.
3. Chiudere le confezioni a tenuta d'aria, per evitare che gli alimenti perdano il gusto o possano essiccarsi.
4. Scrivere sulla confezione il contenuto e la data di congelamento.

## 10.5 Conservazione degli alimenti congelati a $-18\text{ }^{\circ}\text{C}$

Alimento	Tempo di conservazione
Pesce, insaccati di carne, cibi cotti, prodotti da forno	fino a 6 mesi
Carne, pollame	fino a 8 mesi
Frutta, verdura	fino a 12 mesi

## 10.6 Metodi di scongelamento per alimenti congelati

### ATTENZIONE

#### Pericolo di danni alla salute!

Durante lo sbrinamento possono aumentare i batteri e i prodotti surgelati possono deteriorarsi.

- ▶ Non ricongelare gli alimenti parzialmente o completamente scongelati.
- ▶ Ricongelare solo dopo la cottura.
- ▶ Considerare una durata di conservazione inferiore.
- Scongelare gli alimenti di origine animale, come pesce, carne, formaggio e quark, nel frigorifero.
- Scongelare il pane a temperatura ambiente.
- Preparare gli alimenti per il consumo immediato nel microonde, nel forno o sui fornelli.

# 11 Scongelamento

## 11.1 Scongelamento nel frigorifero

A seconda della funzione, durante il funzionamento si formano gocce d'acqua o brina sulla parete posteriore del frigorifero. La parete posteriore del frigorifero si sbrina automaticamente.

→ Fig. 4

L'acqua di sbrinamento scorre attraverso l'apposito convogliatore nel foro di scarico verso la vaschetta di evaporazione e non deve essere rimossa.

Affinché l'acqua di sbrinamento possa defluire e per evitare la formazione di odori, osservare le seguenti informazioni:

→ "Pulizia del convogliatore dell'acqua di sbrinamento e del foro di scarico", Pagina 69.

## 11.2 Scongelamento nel vano congelatore

Il congelatore non esegue lo sbrinamento automaticamente. Uno strato di brina nel congelatore rallenta il passaggio del freddo agli alimenti congelati e aumenta il consumo di energia elettrica.

### Scongelamento del vano congelatore

Sbrinare regolarmente il congelatore.

1. Attivare la Funzione «super» circa 4 ore prima dello sbrinamento.  
→ "Attivare Funzione «super»", Pagina 65

Gli alimenti raggiungono così temperature molto basse e possono essere conservati a temperatura ambiente più a lungo.

2. Togliere gli alimenti congelati e collocarli in un luogo fresco. Avvolgere gli alimenti congelati in coperture o giornali con accumulatori del freddo, se disponibili.
3. Spegnerne l'apparecchio. → *Pagina 64*
4. Staccare l'apparecchio dalla rete elettrica.  
Togliere la spina del cavo di alimentazione o disattivare il fusibile nella scatola dei fusibili.
5. Per accelerare lo sbrinamento, mettere nel congelatore una pentola con acqua bollente su un sottopentola.
6. Rimuovere l'acqua prodotta dallo scongelamento con un panno morbido o una spugna.
7. Asciugare il vano con un panno morbido e asciutto.
8. Collegare elettricamente l'apparecchio. → *Pagina 62*
9. Introdurre gli alimenti congelati. → *Pagina 66*

---

## 12 Pulizia e cura

Per mantenere a lungo l'apparecchio in buone condizioni, sottoporlo a una cura e a una manutenzione scrupolose.

La pulizia dei punti inaccessibili deve essere effettuata dal servizio di assistenza clienti. La pulizia da parte del servizio di assistenza clienti può comportare costi.

### 12.1 Preparazione dell'apparecchio per la pulizia

1. Spegnerne l'apparecchio. → *Pagina 64*
2. Staccare l'apparecchio dalla rete elettrica.

Togliere la spina del cavo di alimentazione o disattivare il fusibile nella scatola dei fusibili.

3. Togliere tutti gli alimenti e conservarli in un luogo fresco.  
Se disponibili, mettere degli accumulatori del freddo sugli alimenti.
4. Se è presente uno strato di brina, lasciarlo scongelare.
5. Rimuovere tutte le parti dell'attrezzatura e gli accessori dall'apparecchio. → *Pagina 69*

### 12.2 Pulizia dell'apparecchio



#### **AVVERTENZA** **Pericolo di scosse elettriche!**

L'infiltrazione di umidità può provocare una scarica elettrica.

- ▶ Non lavare l'apparecchio con pulitori a vapore o idropulitrici.
- I liquidi che raggiungono l'interno dell'unità d'illuminazione o gli elementi di comando possono essere nocivi.
- ▶ L'acqua con detersivo non deve penetrare nell'unità d'illuminazione o negli elementi di comando.

#### **ATTENZIONE!**

I detersivi non appropriati possono danneggiare le superfici dell'apparecchio.

- ▶ Non utilizzare spugnette dure o abrasive.
- ▶ Non usare prodotti corrosivi o abrasivi.
- ▶ Non utilizzare detersivi a elevato contenuto di alcol,

Se il liquido raggiunge il foro di scarico, la vaschetta di evaporazione può traboccare.

- ▶ Evitare che l'acqua penetri nel foro di scarico.

Lavando i pezzi dell'attrezzatura e gli accessori in lavastoviglie, questi si possono deformare o scolorire.

- ▶ Non lavare mai le parti dell'attrezzatura e gli accessori in lavastoviglie.
1. Preparare l'apparecchio per la pulizia. → *Pagina 68*
  2. Pulire l'apparecchio, le parti dell'attrezzatura, i componenti dell'apparecchio e le guarnizioni della porta utilizzando un panno spugna, acqua tiepida e una quantità esigua di detergente con pH neutro.
  3. Asciugare a fondo con un panno morbido e asciutto.
  4. Inserire le parti dell'attrezzatura.
  5. Collegare elettricamente l'apparecchio. → *Pagina 62*
  6. Inserire gli alimenti.

### **12.3 Pulizia del convogliatore dell'acqua di sbrinamento e del foro di scarico**

Per il libero deflusso dell'acqua di sbrinamento, pulire regolarmente il convogliatore dell'acqua e il foro di scarico.

- ▶ Pulire attentamente il convogliatore dell'acqua e il foro di scarico ad esempio con un bastoncino cotonato.  
→ *Fig. 5*

### **12.4 Rimozione degli accessori**

Se si vogliono pulire a fondo le parti dell'attrezzatura, rimuoverle dall'apparecchio.

#### **Rimozione del ripiano**

- ▶ Sollevare da davanti il ripiano ①, estrarlo e rimuoverlo ②.  
→ *Fig. 6*

#### **Rimozione dello sportello del congelatore**

- ▶ Aprire lo sportello del congelatore e staccarlo dal supporto.  
→ *Fig. 7*

#### **Rimozione del balconcino controporta**

- ▶ Sollevare il balconcino controporta ed estrarlo.  
→ *Fig. 8*

#### **Rimozione del cassetto per frutta e verdura**

1. Estrarre il cassetto della frutta e della verdura finché non si innesta in posizione.
2. Sollevare da davanti il cassetto della frutta e della verdura ① e rimuoverlo ②.  
→ *Fig. 9*

## 13 Sistemazione guasti

I guasti minori possono essere sistemati autonomamente dall'utente. Utilizzare le informazioni per la sistemazione dei guasti prima di contattare il servizio di assistenza clienti. In questo modo si evitano costi non necessari.

### AVVERTENZA

#### Pericolo di scosse elettriche!

Gli interventi di riparazione effettuati in modo non appropriato rappresentano una fonte di pericolo.

- ▶ Solo il personale adeguatamente specializzato e formato può eseguire riparazioni sull'apparecchio.
- ▶ Per la riparazione dell'apparecchio possono essere impiegati soltanto pezzi di ricambio originali.
- ▶ Al fine di evitare pericoli, se il cavo di alimentazione di questo apparecchio subisce danni deve essere sostituito dal produttore, dal suo servizio di assistenza clienti o da persona in possesso di simile qualifica.

Anomalia	Causa e ricerca guasti
L'apparecchio non raffredda, l'indicatore e l'illuminazione sono accesi.	Il programma «dimostrativo» è attivo. <ul style="list-style-type: none"> <li>▶ Eseguire l'autotest dell'apparecchio. → <i>Pagina 72</i></li> <li>✓ Alla fine dell'autotest, l'apparecchio passa al funzionamento normale.</li> </ul>
L'illuminazione LED non funziona.	Sono possibili diverse cause scatenanti. <ul style="list-style-type: none"> <li>▶ Rivolgersi al servizio di assistenza clienti.</li> </ul> <p>Il numero del servizio di assistenza clienti si trova nell'elenco dei centri di assistenza allegato.</p>
La temperatura si discosta notevolmente dall'impostazione.	Sono possibili diverse cause scatenanti. <ol style="list-style-type: none"> <li>1. Spegnerne l'apparecchio. → <i>Pagina 64</i></li> <li>2. Riaccendere l'apparecchio dopo circa 5 minuti. → <i>Pagina 64</i> <ul style="list-style-type: none"> <li>– Se la temperatura è troppo elevata, controllarla di nuovo dopo qualche ora.</li> <li>– Se la temperatura è troppo bassa, controllarla di nuovo il giorno seguente.</li> </ul> </li> </ol>
Il fondo del vano frigorifero è bagnato.	Il convogliatore dell'acqua di sbrinamento o il foro di scarico sono otturati. <ul style="list-style-type: none"> <li>▶ Pulire il convogliatore dell'acqua di sbrinamento e il foro di scarico. → <i>Pagina 69</i></li> </ul>
L'apparecchio emette rumori come gorgoglii, ronzii o scatti.	Nessun guasto. Un motore è in funzione, ad es. gruppo frigorifero, ventola. Il refrigerante fluisce nei tubi. Motore, interruttori ed elettrovalvole si inseriscono o disinseriscono. Nessun trattamento necessario.

---

<b>Anomalia</b>	<b>Causa e ricerca guasti</b>
L'apparecchio produce dei rumori.	Le parti dell'attrezzatura traballano o si incastrano. ▶ Controllare le parti estraibili ed eventualmente inserirle di nuovo correttamente.
	Le bottiglie o le stoviglie si toccano. ▶ Separare le bottiglie o le stoviglie.
	La Funzione «super» è attivata. Nessun trattamento necessario.

---

## 13.1 Interruzione dell'alimentazione elettrica

Durante un'interruzione di corrente la temperatura nell'apparecchio aumenta, riducendo il tempo di conservazione e la qualità degli alimenti congelati.

Sul nostro sito web relativo all'apparecchio, all'interno dei dati tecnici è riportato il tempo di conservazione degli alimenti congelati in caso di anomalia.

### Note

- Durante un'interruzione di corrente, aprire l'apparecchio il meno possibile e non conservare ulteriori alimenti.
- Controllare la qualità degli alimenti dopo l'interruzione dell'alimentazione elettrica.
  - Smaltire gli alimenti che si sono scongelati e hanno una temperatura superiore a 5 °C.
  - Cucinare gli alimenti leggermente scongelati e consumarli o congelarli di nuovo.

## 13.2 Esecuzione dell'autotest dell'apparecchio

1. Spegnerne l'apparecchio. → *Pagina 64*
2. Staccare l'apparecchio dalla rete elettrica.  
Togliere la spina del cavo di alimentazione o disattivare il fusibile nella scatola dei fusibili.
3. Ricollegare elettricamente l'apparecchio dopo 5 minuti. → *Pagina 62*
4. Entro 10 secondi dopo l'accensione, mantenere premuto per 5-7 secondi il tasto di impostazione della temperatura, finché non viene emesso un secondo segnale acustico.

- ✓ Si avvia l'autotest dell'apparecchio.
- ✓ Durante l'autotest, di tanto in tanto viene emesso un lungo segnale acustico.
- ✓ Se al termine dell'autotest vengono emessi 2 segnali acustici e *Super* lampeggia due volte significa che l'apparecchio funziona regolarmente. L'apparecchio passa al funzionamento normale.
- ✓ Se al termine dell'autotest viene emesso 5 volte il segnale acustico e *Super* lampeggia per 10 secondi, informare il servizio di assistenza clienti.

---

## 14 Stoccaggio e smaltimento

Di seguito sono indicate informazioni per preparare l'apparecchio per l'immagazzinamento. Vi sono anche informazioni sulla rottamazione degli apparecchi dismessi.

### 14.1 Messa fuori servizio dell'apparecchio

1. Spegnerne l'apparecchio. → *Pagina 64*
2. Staccare l'apparecchio dalla rete elettrica.  
Togliere la spina del cavo di alimentazione o disattivare il fusibile nella scatola dei fusibili.
3. Estrarre tutti gli alimenti.
4. Scongelerne l'apparecchio. → *Pagina 67*
5. Pulire l'apparecchio. → *Pagina 68*
6. Per garantire un'aerazione nel vano interno, lasciare aperto l'apparecchio.



## 14.2 Rottamazione di un apparecchio dismesso

Un corretto smaltimento nel rispetto dell'ambiente permette di recuperare materie prime preziose.

### **AVVERTENZA**

#### **Pericolo di danni alla salute!**

I bambini possono restare chiusi nell'apparecchio, rischiando la vita.

- ▶ Per rendere difficile ai bambini l'ingresso nell'apparecchio, non rimuovere dal suo interno ripiani e contenitori.
- ▶ Tenere i bambini lontano dall'apparecchio dismesso.

### **AVVERTENZA**

#### **Pericolo di incendio!**

In caso di danneggiamento dei tubi, il refrigerante infiammabile e i gas nocivi possono fuoriuscire e prendere fuoco.

- ▶ Non danneggiare i tubi del circuito refrigerante e l'isolamento.
1. Staccare la spina del cavo di alimentazione.
  2. Tagliare il cavo di alimentazione.
  3. Smaltire l'apparecchio nel rispetto dell'ambiente.

Per informazioni sulle attuali procedure di smaltimento rivolgersi al rivenditore specializzato o al comune di competenza.



Questo apparecchio dispone di contrassegno ai sensi della direttiva europea 2012/19/UE in materia di apparecchi elettrici ed elettronici

(waste electrical and electronic equipment - WEEE).

Questa direttiva definisce le norme per la raccolta e il riciclaggio degli apparecchi dismessi valide su tutto il territorio dell'Unione Europea.

## 15 Servizio di assistenza clienti

In caso di domande, se non si riesce a sistemare un guasto in autonomia o se l'apparecchio deve essere riparato, rivolgersi al nostro servizio di assistenza clienti.

I ricambi originali rilevanti per il funzionamento secondo il corrispondente regolamento Ecodesign sono reperibili presso il nostro servizio di assistenza clienti per un periodo di almeno 10 anni a partire dalla messa in circolazione dell'apparecchio all'interno dello Spazio economico europeo.

**Nota:** L'intervento del servizio di assistenza clienti è gratuito nell'ambito delle condizioni di garanzia del produttore applicabili a livello locale. La durata minima della garanzia (garanzia del produttore per utenti privati) nello Spazio economico europeo è di 2 anni secondo le condizioni di garanzia applicabili a livello locale. Le condizioni di garanzia non producono alcun effetto su altri diritti o rivendicazioni spettanti conformemente al diritto locale.

Informazioni dettagliate sulla durata della garanzia e sulle condizioni di garanzia in ciascun Paese sono reperibili presso il nostro servizio di assistenza clienti, presso il proprio rivenditore o sul nostro sito Internet.

## it Dati tecnici

Quando si contatta il servizio di assistenza clienti sono necessari il codice prodotto (E-Nr.) e il codice di produzione (FD) dell'apparecchio.

I dati di contatto del servizio di assistenza clienti sono disponibili nell'elenco dei centri di assistenza allegato o sul nostro sito Internet.

### 15.1 Codice prodotto (E-Nr.) e codice di produzione (FD)

Il codice prodotto (E-Nr.) e il codice di produzione (FD) sono riportati sulla targhetta identificativa dell'apparecchio.

→ Fig. 1/4

Annotare i dati dell'apparecchio e il numero di telefono del servizio di assistenza clienti per ritrovarli rapidamente.

alternativa, l'indicazione del modello si trova anche nella prima riga dell'etichetta energetica UE.

---

## 16 Dati tecnici

Il refrigerante, il contenuto utile ed altri dati tecnici sono indicati sulla targhetta identificativa.

→ Fig. 1/4

Il prodotto contiene una sorgente luminosa con classe di efficienza energetica E. Tale sorgente è disponibile come componente di ricambio e deve essere sostituita esclusivamente da personale qualificato.

Ulteriori informazioni sul modello scelto sono disponibili sul sito Internet <https://eprel.ec.europa.eu/><sup>1</sup>. Questo link rimanda alla pagina ufficiale del database europeo dei prodotti EPREL. Seguire quindi le indicazioni relative alla ricerca del modello. Si riconosce il modello dal segno prima della barra del codice prodotto (E-Nr.) sulla targhetta identificativa. In al-

---

<sup>1</sup> Valido solo per i Paesi dello Spazio economico europeo

# Inhoudsopgave

<b>1 Veiligheid</b> .....	<b>77</b>	<b>8 Extra functies</b> .....	<b>87</b>
1.1 Algemene aanwijzingen .....	77	8.1 Super-functie .....	87
1.2 Bestemming van het apparaat .....	77	<b>9 Koelvak</b> .....	<b>87</b>
1.3 Inperking van de gebruikers ....	77	9.1 Tips voor het bewaren van levensmiddelen in het koelvak .....	87
1.4 Veiliger transport .....	77	9.2 Koudezones in het koelvak .....	88
1.5 Veilige installatie.....	78	9.3 Sticker "OK" .....	88
1.6 Veilig gebruik.....	79	<b>10 Vriesvak</b> .....	<b>88</b>
1.7 Beschadigd apparaat.....	81	10.1 Deur van het vriesvak.....	88
<b>2 Het voorkomen van materiële schade</b> .....	<b>83</b>	10.2 Invriescapaciteit.....	88
<b>3 Milieubescherming en besparing</b> .....	<b>83</b>	10.3 Tips voor het bewaren van levensmiddelen in het vriesvak .....	89
3.1 Afvoeren van de verpakking ....	83	10.4 Tips voor het bevroren van verse levensmiddelen .....	89
3.2 Energie besparen .....	83	10.5 Houdbaarheid van de diepvrieswaren bij -18 °C .....	89
<b>4 Opstellen en aansluiten</b> .....	<b>83</b>	10.6 Ontdooimethodes voor diepvrieswaren .....	89
4.1 Leveringsomvang .....	83	<b>11 Ontdooien</b> .....	<b>90</b>
4.2 Criteria voor de opstellocatie ...	84	11.1 Ontdooien in het koelvak. ....	90
4.3 Apparaat monteren .....	84	11.2 Ontdooien in het vriesvak .....	90
4.4 Het apparaat voor het eerste gebruik voorbereiden .....	84	<b>12 Reiniging en onderhoud</b> .....	<b>90</b>
4.5 Apparaat elektrisch aansluiten.....	85	12.1 Apparaat voorbereiden voor reiniging .....	90
<b>5 Uw apparaat leren kennen</b> .....	<b>85</b>	12.2 Apparaat schoonmaken.....	91
5.1 Apparaat.....	85	12.3 De dooiwatergoot en het afvoergat reinigen.....	91
5.2 Bedieningspaneel.....	85	12.4 Onderdelen eruit halen .....	91
<b>6 Uitrusting</b> .....	<b>85</b>	<b>13 Stringen verhelpen</b> .....	<b>93</b>
6.1 Legplateau.....	85	13.1 Stroomuitval.....	95
6.2 Klep van het vriesvak .....	85	13.2 Apparaatzelftest uitvoeren.....	95
6.3 Groente- en fruitlade.....	85	<b>14 Opslaan en afvoeren</b> .....	<b>95</b>
6.4 Boter- en kaasvak .....	86	14.1 Apparaat buiten gebruik stellen .....	95
6.5 Deurrekken.....	86	14.2 Afvoeren van uw oude apparaat .....	96
6.6 Accessoires.....	86		
<b>7 De Bediening in essentie</b> .....	<b>86</b>		
7.1 Apparaat inschakelen.....	86		
7.2 Opmerkingen bij het gebruik ...	86		
7.3 Machine uitschakelen.....	86		
7.4 Temperatuur instellen.....	87		

nl

<b>15 Servicedienst.....</b>	<b>96</b>
15.1 Productnummer (E-nr.) en productienummer (FD).....	97
<b>16 Technische gegevens.....</b>	<b>97</b>



## 1 Veiligheid

Neem de volgende veiligheidsvoorschriften in acht.

### 1.1 Algemene aanwijzingen

- Lees deze gebruiksaanwijzing zorgvuldig door.
- Bewaar de gebruiksaanwijzing en de productinformatie voor later gebruik of voor volgende eigenaren.
- Sluit het apparaat in geval van transportschade niet aan.

### 1.2 Bestemming van het apparaat

Dit apparaat is uitsluitend voor de inbouw bedoeld.

Gebruik het apparaat uitsluitend:

- om levensmiddelen te koelen en in te vriezen en voor de bereiding van ijsblokjes.
- voor huishoudelijk gebruik en in gesloten ruimtes binnen de huiselijke omgeving.
- tot een hoogte van 2000 m boven zeeniveau.

### 1.3 Inperking van de gebruikers

Dit apparaat kan worden bediend door kinderen vanaf 8 jaar en door personen met fysieke, sensorische of geestelijke beperkingen of met gebrekkige ervaring en/of kennis, indien zij onder toezicht staan of zijn geïnstrueerd in het veilige gebruik van het apparaat en de daaruit resulterende gevaren hebben begrepen.

Kinderen mogen niet met het apparaat spelen.

Reiniging en gebruikersonderhoud mogen niet worden uitgevoerd door kinderen indien deze niet onder toezicht staan.

Kinderen vanaf 3 jaar en jonger dan 8 jaar mogen de koelkast/diepvriezer vullen en legen.

### 1.4 Veiliger transport

#### **WAARSCHUWING – Kans op letsel!**

Het hoge gewicht van het apparaat kan bij het optillen letsels veroorzaken.

- ▶ Het apparaat niet alleen optillen.

## 1.5 Veilige installatie

### **⚠ WAARSCHUWING – Kans op elektrische schok!**

Ondeskundige installaties zijn gevaarlijk.

- ▶ Het apparaat uitsluitend aansluiten en gebruiken volgens de gegevens op het typeplaatje.
- ▶ Het apparaat uitsluitend via een volgens de voorschriften geïnstalleerd stopcontact met randaarde op een stroomnet met wisselstroom aansluiten.
- ▶ Het randaardesysteem van de elektrische huisinstallatie moet conform de elektrotechnische voorschriften zijn geïnstalleerd.
- ▶ Nooit het apparaat via een externe schakelinrichting voeden, bijvoorbeeld een tijdschakelaar of besturing op afstand.
- ▶ Wanneer het apparaat is ingebouwd, moet de netstekker van de netaansluitkabel vrij toegankelijk zijn, of wanneer vrije toegang niet mogelijk is, moet in de vast geplaatste elektrische installatie een alpolige scheidingsinrichting volgens de installatievoorschriften worden ingebouwd.
- ▶ Bij het opstellen van het apparaat erop letten dat het netsnoer niet wordt afgeklemd of beschadigd.

Een beschadigde isolatie van het netsnoer is gevaarlijk.

- ▶ Nooit het aansluitsnoer met warmtebronnen in contact brengen.

### **⚠ WAARSCHUWING – Kans op explosie!**

Wanneer de ventilatie-openingen van het apparaat zijn gesloten, dan kan bij een lek van het koude circuit een brandbaar gas-luchtmengsel ontstaan.

- ▶ Sluit ventilatie-openingen in de behuizing van het apparaat of in de inbouwbehuizing niet af.

### **⚠ WAARSCHUWING – Kans op brand!**

Het gebruik van een verlengd netsnoer en niet-toegestane adapters is gevaarlijk.

- ▶ Geen verlengsnoeren of meervoudige stopcontacten gebruiken.
- ▶ Als het netsnoer te kort is, contact opnemen met de servicedienst.
- ▶ Alleen door de fabrikant goedgekeurde adapters gebruiken.

Draagbare mobiele meervoudige stopcontacten of draagbare netvoedingen kunnen oververhit raken en tot brand leiden.

- ▶ Draagbare mobiele meervoudige stopcontacten of draagbare netvoedingen niet aan de achterkant van de apparaten plaatsen.

## 1.6 Veilig gebruik

### **⚠ WAARSCHUWING – Kans op elektrische schok!**

Binnendringend vocht kan een elektrische schok veroorzaken.

- ▶ Gebruik het apparaat alleen in gesloten ruimtes.
- ▶ Stel het apparaat nooit bloot aan grote hitte en vochtigheid.
- ▶ Geen stoomreiniger of hogedrukreiniger gebruiken om het apparaat te reinigen.

### **⚠ WAARSCHUWING – Kans op verstikking!**

Kinderen kunnen verpakkingsmateriaal over het hoofd trekken en hierin verstrikt raken en stikken.

- ▶ Verpakkingsmateriaal uit de buurt van kinderen houden.
  - ▶ Laat kinderen niet met verpakkingsmateriaal spelen.
- Kinderen kunnen kleine onderdelen inademen of inslikken en hierdoor stikken.
- ▶ Kleine onderdelen uit de buurt van kinderen houden.
  - ▶ Kinderen niet met kleine onderdelen laten spelen.

### **⚠ WAARSCHUWING – Kans op explosie!**

Door beschadiging van de koudemiddelkringloop kan brandbaar koudemiddel lekken en exploderen.

- ▶ Gebruik voor het versnellen van het ontdooien geen andere mechanische inrichtingen of andere middelen dan diegene die door de fabrikant zijn aanbevolen.
- ▶ Maak vastgevroren levensmiddelen met een stomp voorwerp los, bijv. met een steel van een houten lepel.

Producten met brandbare drijfgassen en explosieve stoffen kunnen exploderen, bijv. spuitbussen.

- ▶ Bewaar geen producten met brandbare drijfgassen en explosieve stoffen in het apparaat.

### **⚠ WAARSCHUWING – Kans op brand!**

Elektrische apparaten binnenin het apparaat kunnen tot een brand leiden, bijv. verwarmingsapparaten of elektrische ijsbereiders.

- ▶ Gebruik geen elektrische apparaten binnenin het apparaat.

### **⚠ WAARSCHUWING – Kans op letsel!**

Flessen of blikjes met koolzuurhoudende drank kunnen barsten.

- ▶ Geen flessen of blikjes met koolzuurhoudende drank in het vriesvak bewaren.

Letsel aan de ogen door lekkend brandbaar koudemiddel en schadelijke gassen.

- ▶ De buizen van de koudemiddelkringloop en de isolatie niet beschadigen.

### **⚠ WAARSCHUWING – Kans op koude-brandwonden!**

Contact met diepvrieswaren en koude oppervlakken kan tot brandwonden door koude leiden.

- ▶ Nooit diepvrieswaren in de mond nemen nadat deze uit het vriesvak werden genomen.
- ▶ Vermijd langer contact van de huid met diepvrieswaren, ijs en oppervlakken van het vriesvak.

### **⚠ VOORZICHTIG – Kans op gevaar voor de gezondheid!**

Houd de volgende aanwijzingen aan om verontreiniging van levensmiddelen te voorkomen.

- ▶ Wanneer de deur langere tijd wordt geopend, kan dit leiden tot een aanzienlijke temperatuurstijging in de vakken van het apparaat.
- ▶ Maak de oppervlakken, die met levensmiddelen en toegankelijke afvoersystemen in contact komen, regelmatig schoon.
- ▶ Rauw vlees en vis in geschikte containers in de koelkast dusdanig bewaren dat het niet in contact komt met andere levensmiddelen of op deze drupt.
- ▶ Wanneer het koel-/vriesapparaat langere tijd leeg staat, het apparaat uitschakelen, ontdooien, reinigen en de deur open laten, om schimmelvorming te voorkomen.



Delen in het apparaat van metaal of met een metalen uiterlijk kunnen aluminium bevatten. Wanneer zure levensmiddelen in contact komen met aluminium in contact komen, dan kunnen aluminiumionen overdragen naar de levensmiddelen.

- ▶ Verontreinigde levensmiddelen niet consumeren.

## 1.7 Beschadigd apparaat

### **WAARSCHUWING – Kans op elektrische schok!**

Een beschadigd apparaat of een beschadigd netsnoer is gevaarlijk.

- ▶ Nooit een beschadigd apparaat gebruiken.
- ▶ Nooit aan het netsnoer trekken, om het apparaat van het elektriciteitsnet te scheiden. Altijd aan de stekker van het netsnoer trekken.
- ▶ Wanneer het apparaat of het netsnoer is beschadigd, dan direct de stekker van het netsnoer uit het stopcontact halen of de zekering in de meterkast uitschakelen.
- ▶ Contact opnemen met de servicedienst. → *Pagina 96*

Ondeskundige reparaties zijn gevaarlijk.

- ▶ Alleen daarvoor geschoold vakpersoneel mag reparaties aan het apparaat uitvoeren.
- ▶ Er mogen uitsluitend originele reserveonderdelen worden gebruikt voor reparatie van het apparaat.
- ▶ Als het netsnoer van dit apparaat beschadigd raakt, moet het ter vermijding van risico's worden vervangen door de fabrikant, de servicedienst of een andere gekwalificeerde persoon.

### **WAARSCHUWING – Kans op brand!**



Bij beschadiging van de leidingen kunnen brandbaar koudemiddel en schadelijke gassen ontsnappen en ontsteken.

- ▶ Houd vuur en ontstekingsbronnen uit de buurt van het apparaat.
- ▶ Ventileer de ruimte.
- ▶ Het apparaat uitschakelen. → *Pagina 86*

**nl** Veiligheid

- ▶ De stekker van het netsnoer uit het stopcontact trekken of de zekering in de meterkast uitschakelen.
- ▶ Neem contact op met de service-afdeling. → *Pagina 96*

---

## 2 Het voorkomen van materiële schade

### LET OP!

Door het gebruik van de plint, laden of apparaatdeuren als zitvlak of opstapje kan het apparaat beschadigd raken.

- ▶ Niet op de plint, laden of deuren staat of leunen.

Door verontreinigingen met olie of vet kunnen kunststofdelen en deurafdichtingen poreus worden.

- ▶ Houd kunststofdelen en deurafdichtingen olie- en vetvrij.

Delen in het apparaat van metaal of met een metalen uiterlijk kunnen aluminium bevatten. Aluminium reageert bij contact met zure levensmiddelen.

- ▶ Geen levensmiddelen onverpakt in het apparaat bewaren.

---

## 3 Milieubescherming en besparing

### 3.1 Afvoeren van de verpakking

De verpakkingsmaterialen zijn milieuvriendelijk en kunnen worden hergebruikt.

- ▶ De afzonderlijke componenten op soort gescheiden afvoeren.

### 3.2 Energie besparen

Als u deze aanwijzingen opvolgt, verbruikt uw apparaat minder stroom.

#### Keuze van de opstellingslocatie

- Stel het apparaat niet bloot aan direct zonlicht.

- Plaats het apparaat zo ver mogelijk van radiatoren, fornuis en andere warmtebronnen:
  - Houd 30 mm afstand aan tot elektrische- of gasfornuizen.
  - Houd 300 mm afstand aan tot olie- en kolenfornuizen.
- De externe ventilatieopeningen nooit afdekken of blokkeren.

#### Energie besparen bij het gebruik.

**Opmerking:** De plaatsing van de uitrustingsonderdelen heeft geen invloed op het energieverbruik van het apparaat.

- Open het apparaat slechts kort en sluit het zorgvuldig.
- De binnenste ventilatieopeningen of de externe ventilatieopeningen nooit afdekken of blokkeren.
- Transporteer gekoelde levensmiddelen in een koeltas en leg ze snel in het apparaat.
- Warm voedsel en dranken eerst laten afkoelen, daarna in het apparaat plaatsen.
- Leg om de koude van de diepvriesproducten te benutten, deze ter ontdooiing in het koelvak.
- Laat altijd wat ruimte tussen de levensmiddelen en de achterwand.
- Ontdooi het vriesvak regelmatig.
- Open het vriesvak slechts kort en sluit het zorgvuldig.

---

## 4 Opstellen en aansluiten

### 4.1 Leveringsomvang

Controleer na het uitpakken alle onderdelen op transportschade en de volledigheid van de levering.

Neem bij klachten met uw dealer of onze servicedienst → *Pagina 96* contact op.

De levering bestaat uit:

## nl Opstellen en aansluiten

- Inbouw
- Uitrusting en accessoires<sup>1</sup>
- Montagemateriaal
- Montagehandleiding
- Gebruiksaanwijzing
- Klantenservice overzicht
- Garantiebijlage<sup>2</sup>
- Energielabel
- Informatie over energieverbruik en geluiden

## 4.2 Criteria voor de opstellocatie

### WAARSCHUWING

#### Kans op explosie!

Wanneer het apparaat in een te kleine ruimte staat, kan er bij een lek van het koudecircuit een brandbaar gasluchtmengsel ontstaan.

- ▶ Stel het apparaat uitsluitend op in een ruimte, welke tenminste een volume heeft van 1 m<sup>3</sup> per 8 g koudemiddel. De hoeveelheid van het koudemiddel staat op het typeplaatje. → Fig. 1/4

Het gewicht van het apparaat kan afhankelijk van het model tot 45 bedragen.

De ondergrond moet stabiel genoeg zijn om het gewicht van het apparaat te dragen.

### Toegestane ruimtetemperatuur

De toegestane kamertemperatuur is afhankelijk van de klimaatklasse van het apparaat.

De klimaatklasse vindt u op het typeplaatje. → Fig. 1/4

Klimaat-klasse	Toegestane ruimtetemperatuur
SN	10 °C...32 °C

Klimaat-klasse	Toegestane ruimtetemperatuur
N	16 °C...32 °C
ST	16 °C...38 °C
T	16 °C...43 °C

Het apparaat is volledig functioneel binnen de toegestane binnentemperatuur.

Wanneer u een apparaat van de klimaatklasse SN gebruikt bij lagere kamertemperaturen, dan kunnen beschadigingen aan het apparaat tot een kamertemperatuur van 5 °C worden uitgesloten.

### Over-and-Under- en Side-by-Side-opstelling

Als u 2 koeltoestellen boven of naast elkaar wilt opstellen, moet u tussen de toestellen minimaal een tussenafstand van 150 mm aanhouden. Voor bepaalde toestellen is een opstelling zonder minimumafstand mogelijk. Neem hiervoor contact op met uw dealer of keukinstallateur.

## 4.3 Apparaat monteren

- ▶ Het apparaat conform meegeleverde montagehandleiding monteren.

## 4.4 Het apparaat voor het eerste gebruik voorbereiden

1. Haal het informatiemateriaal er uit.
2. Verwijder de beschermfolie en transportborgingen, bijv. plakstrips en karton.
3. Het apparaat voor de eerste keer reinigen. → Pagina 91

<sup>1</sup> Afhankelijk van de apparaatuitvoering

<sup>2</sup> Niet in alle landen

## 4.5 Apparaat elektrisch aansluiten

- De netstekker van het aansluit-snoer van het apparaat in een stopcontact in de omgeving van het apparaat steken.  
De aansluitgegevens van het apparaat staan op het typeplaatje.  
→ Fig. 1/4
  - De netstekker op vastheid controleren.
- ✓ Het apparaat is nu gereed voor gebruik.

## 5 Uw apparaat leren kennen

### 5.1 Apparaat

Hier vindt u een overzicht van de onderdelen van uw apparaat.

→ Fig. 1

1	Bedieningspaneel → Pagina 85
2	Vriesvak → Pagina 88
3	Groente- en fruitlade → Pagina 85
4	Typeplaatje → Pagina 97
5	Boter- en kaasvak → Pagina 86
6	Deurrek voor grote flessen → Pagina 86

**Opmerking:** Verschillen tussen uw apparaat en de afbeeldingen zijn mogelijk op basis van uitrusting en grootte.

## 5.2 Bedieningspaneel

Via het bedieningsveld kunt u alle functies van uw apparaat instellen en informatie krijgen over de gebruikstoestand.

→ Fig. 2

1	De temperatuurinsteltoets stelt de temperatuur van het koelvak in.
2	Super brandt, wanneer Superkoelen is ingeschakeld.
3	Toont de ingestelde temperatuur van het koelvak in °C.

## 6 Uitrusting

De uitrusting van uw apparaat is modelafhankelijk.

### 6.1 Legplateau

Om de schappen naar wens te variëren, kunt u het schap uitnemen en op een andere positie weer plaatsen.

→ "Plateau verwijderen", Pagina 91

### 6.2 Klep van het vriesvak

Bewaar op het legplateau achter de klep van het vriesvak vaak gebruikte of kortstondig te bewaren levensmiddelen.

### 6.3 Groente- en fruitlade

Bewaar vers fruit en groente verpakt in de fruit- en groentelade.

Bewaar gesneden fruit en groente afgedekt of luchtdicht verpakt.

Afhankelijk van de soort levensmiddelen en de hoeveelheid kan zich in de fruit- en groentelade condenswater vormen.

Verwijder het condenswater met een droge doek.

Om ervoor te zorgen dat de kwaliteit en het aroma behouden blijven, moet u koudegevoelig fruit en groente buiten het apparaat bewaren bij temperaturen van ca. 8 °C tot 12 °C, bijv. ananas, bananen, citrusvruchten, augurken, courgette, paprika, tomaten en aardappelen.

## 6.4 Boter- en kaasvak

Bewaar boter en harde kaas in het boter- en kaasvak.

## 6.5 Deurrekken

Om het deurrek naar behoefte te variëren kunt u het deurrek er uit nemen en op een andere positie weer plaatsen.

→ "Deurrek verwijderen", Pagina 92

## 6.6 Accessoires

Gebruik alleen originele accessoires. Deze zijn op het apparaat afgestemd. De accessoires van het apparaat zijn afhankelijk van het model.

### Eierplateau

Bewaar eieren veilig op het eierplateau.

### Flessenrek

Bewaar flessen veilig op het flessenrek.

→ Fig. 3

### Ijsblokjeschaal

Gebruik de ijsblokjeschaal om ijsblokjes te maken.

### Ijsblokjes maken

Gebruik voor het maken van ijsblokjes uitsluitend drinkwater.

1. Vul de schaal voor ijsblokjes voor  $\frac{3}{4}$  met drinkwater en plaats deze in het diepvriesvak.

Vastgevroren ijsblokjeschaal alleen met een bot voorwerp, bijv. steel van een lepel, losmaken.

2. Om de ijsblokjeschaal los te maken de ijsblokjeschaal iets torderen of kort onder stromend water houden.

---

## 7 De Bediening in essentie

### 7.1 Apparaat inschakelen

1. Het apparaat elektrisch aansluiten.  
→ Pagina 85

**Opmerking:** Wanneer het apparaat eerder via het bedieningspaneel werd uitgeschakeld, <sup>3 sec.</sup> ① 3 seconden ingedrukt houden.

- ✓ Het apparaat begint te koelen.
2. De gewenste temperatuur instellen.  
→ Pagina 87

### 7.2 Opmerkingen bij het gebruik

- Wanneer u het apparaat heeft ingeschakeld, duurt het tot enkele uren voordat de ingestelde temperatuur wordt bereikt.  
Plaats geen levensmiddelen in het apparaat voordat de ingestelde temperatuur is bereikt.
- Wanneer u de deur sluit, kan een onderdruk ontstaan. De deur gaat dan alleen moeilijker open. Wacht een ogenblik tot de onderdruk wordt gecompenseerd.

### 7.3 Machine uitschakelen

- ▶ <sup>3 sec.</sup> ① 3 Seconden ingedrukt houden.

## 7.4 Temperatuur instellen

### Koelvaktemperatuur instellen

- ▶ Druk net zo vaak op de temperatuurinsteltoets tot de gewenste temperatuur op het temperatuurdisplay wordt weergegeven.

De aanbevolen temperatuur in het koelvak bedraagt 4 °C.

→ "Sticker "OK"", Pagina 88

### Vriesvaktemperatuur instellen

- ▶ Om de vriesvaktemperatuur in te stellen, de koelvaktemperatuur wijzigen → Pagina 87.

De koelvaktemperatuur beïnvloedt de vriesvaktemperatuur. Hoger ingestelde koelvaktemperaturen zorgen voor hogere vriesvaktemperaturen.

---

## 8 Extra functies

### 8.1 Super-functie

Bij de Super-functie koelen het koelvak en het vriesvak sterker. Schakel de Super-functie 4 tot 6 uur vóór het opslaan van een hoeveelheid levensmiddelen vanaf 2 kg in. Om het invriesvermogen te benutten, gebruikt u de Super-functie. → "Invriescapaciteit", Pagina 88

**Opmerking:** Als de Super-functie is ingeschakeld, kan er meer geluid ontstaan.

### Super-functie inschakelen

- ▶ Druk net zo vaak op de temperatuurinsteltoets tot Super brandt.

**Opmerking:** Na ca. 24 uur schakelt het apparaat over op de normale werking.

### Super-functie uitschakelen

- ▶ Druk op de temperatuurinsteltoets.

---

## 9 Koelvak

In het koelvak kunt u vlees, worst, vis, melkproducten, eieren, bereide gerechten en brood en banket bewaren.

De temperatuur is van 2 °C tot 8 °C instelbaar.

Door de koelopslag kunt u ook licht bederfelijke levensmiddelen op korte of middellange termijn bewaren. Hoe lager de gekozen temperatuur is, des te langer blijven de levensmiddelen vers.

### 9.1 Tips voor het bewaren van levensmiddelen in het koelvak

- Alleen verse en onbeschadigde levensmiddelen inruimen.
- Bewaar de levensmiddelen luchtdicht verpakt of afgedekt.
- Om de luchtcirculatie niet te hinderen en het bevroren van levensmiddelen te vermijden, de levensmiddelen niet direct tegen de achterwand plaatsen.
- Laat warme etenswaren en dranken eerst afkoelen.
- Houd de door de fabrikant vermelde houdbaarheidsdatum of gebruiksdatum in acht.

## 9.2 Koudezones in het koelvak

Door de luchtcirculatie in et koelvak ontstaan verschillende koudezones.

### Koudste zone

De koudste zone is tussen de op de zijkant gestempelde pijl en het eronder liggende legplateau.

**Tip:** Bewaar snel bedervende levensmiddelen in de koudste zone, bijv. vis, worst en vlees.

### Warmste zone

De warmste zone bevindt zich helemaal bovenaan in de deur.

**Tip:** Bewaar minder gevoelige levensmiddelen in de warmste zone, bijv. harde kaas en boter. Hierdoor komt het aroma van de kaas beter tot ontwikkeling en blijft de boter smeerbaar.

## 9.3 Sticker "OK"

Met de sticker OK kunt u controleren of in het koelvak de voor de levensmiddelen aanbevolen veilige temperatuurbereiken van +4°C of kouder bereikt zijn.

De sticker OK wordt niet bij alle modellen meegeleverd.

Wanneer de sticker OK niet weergeeft, dan de temperatuur stapsgewijze verlagen.

→ *"Koelvaktemperatuur instellen", Pagina 87*

Na ingebruikneming van het apparaat kan het tot wel 12 uur duren voordat de ingestelde temperatuur is bereikt.



Correcte instelling

---

## 10 Vriesvak

In het vriesvak kunt u diepvrieswaren bewaren, levensmiddelen bevroren en ijsblokjes maken.

De temperatuur in het vriesvak is afhankelijk van de temperatuur in het koelvak.

Langdurig bewaren van levensmiddelen moet op een temperatuur van – 18 °C of lager gebeuren.

Door het invriezen kunt u bederfelijke levensmiddelen gedurende lange tijd bewaren. De lage temperaturen vertragen of stoppen het bederven.

### 10.1 Deur van het vriesvak

Om ervoor te zorgen dat diepvrieswaren niet ontdooien en het vriesvak niet te sterk verijst, dient u de deur van het vriesvak altijd te sluiten.

### 10.2 Invriescapaciteit

Het invriesvermogen geeft aan welke hoeveelheid levensmiddelen in hoeveel uur tot in de kern kan worden ingevroren.

Informatie over het invriesvermogen vindt u op het typeplaatje. → Fig. 11/

4

### Voorwaarden voor invriesvermogen

1. Bij het inladen van verse levensmiddelen, Super-functie inschakelen.  
→ *"Super-functie inschakelen", Pagina 87*
2. Verse levensmiddelen het best zo dicht mogelijk achteraan tegen de zijwanden invriezen.



### 10.3 Tips voor het bewaren van levensmiddelen in het vriesvak

- Bewaar de levensmiddelen luchtdicht verpakt.
- Breng in te vriezen levensmiddelen niet in aanraking met ingevroren levensmiddelen.
- De levensmiddelen over een groot oppervlak van het vriesvak verdeelen.

### 10.4 Tips voor het bevriezen van verse levensmiddelen

- Alleen verse en onberispelijke levensmiddelen bevriezen.
- Levensmiddelen per portie invriezen.
- Bereide levensmiddelen zijn beter geschikt dan rauw eetbare levensmiddelen.
- Groente vóór het invriezen wassen, kleiner maken en blancheren.
- Fruit vóór het invriezen wassen, ontpitten en eventueel schillen, eventueel suiker of ascorbinezuuroplossing toevoegen.
- Voor het invriezen geschikte levensmiddelen zijn bijv. bakwaren, vis en zeevruchten, vlees, wild en gevogelte, eieren zonder schaal, kaas, boter, kwark, kant-en-klaargerechten en etensresten.
- Voor het invriezen ongeschikte levensmiddelen zijn bijv. kropsla, radijsjes, eieren met schaal, druiven, rode appels en peren, yoghurt, zure room, crème fraîche en mayonaise.

### Diepvrieswaren verpakken

Geschikt verpakkingsmateriaal en de juiste soort verpakking behouden in hoge mate de productkwaliteit en vermijden vriesbrand.

1. De levensmiddelen in de verpakking leggen.
2. De lucht eruit drukken.
3. De verpakking luchtdicht afsluiten om te voorkomen dat de levensmiddelen hun smaak verliezen of uitdrogen.
4. De verpakking met de inhoud van de invriesdatum voorzien.

### 10.5 Houdbaarheid van de diepvrieswaren bij $-18\text{ }^{\circ}\text{C}$

Product	Bewaartijd
Vis, worst, klaarge- maakte gerechten, brood en banket	Tot 6 maanden
Gevogelte, vlees	Tot 8 maanden
Groente, fruit	Tot 12 maanden

### 10.6 Ontdooimethodes voor diepvrieswaren



#### VOORZICHTIG

#### Kans op gevaar voor de gezondheid!

- Bij het ontdooien kunnen bacteriën zich vermeerderen en kunnen de diepvrieswaren bederven.
- ▶ Half of geheel ontdooide diepvrieswaren niet opnieuw invriezen.
  - ▶ Het voedsel pas na koken of braden opnieuw invriezen.
  - ▶ De maximale bewaartijd niet meer ten volle benutten.
- Dierlijke levensmiddelen in het koelvak ontdooien, bijv. vis, vlees, kaas en kwark.
  - Brood bij kamertemperatuur ontdooien.

- Levensmiddelen voor directe consumptie in de magnetron, in de oven of op het fornuis bereiden.

---

## 11 Ontdooien

### 11.1 Ontdooien in het koelvak.

Tijdens het gebruik vormen zich op de achterwand van het koelvak afhankelijk van de werking waterdruppels of rijp. De achterwand van het koelvak ontdooit automatisch.

→ Fig. 4

Het dooiwater loopt via de dooiwatergoot in het afvoergat naar de verdampingsschaal en hoeft niet worden afgeveegd.

Neem de volgende informatie in acht om ervoor te zorgen dat dooiwater kan weglopen en geurvorming wordt vermeden:

→ "De dooiwatergoot en het afvoergat reinigen.", Pagina 91.

### 11.2 Ontdooien in het vriesvak

Het diepvriesvak ontdooit niet automatisch. Een laag rijp in het vriesvak vermindert de afgifte van koude aan de diepvrieswaren en verhoogt het energieverbruik.

#### Vriesvak ontdooien

Het vriesvak regelmatig ontdooien.

1. Ca. 4 uur vóór het ontdooien de Super-functie inschakelen.  
→ "Super-functie inschakelen", Pagina 87

De levensmiddelen bereiken hierdoor heel lage temperaturen en u kunt de levensmiddelen langer op kamertemperatuur bewaren.

2. De diepvrieswaren verwijderen en op een koele plaats bewaren. De diepvriesproducten in dekens of krantenpapier met koelelementen, indien voorhanden, wikkelen.

3. Het apparaat uitschakelen.

→ Pagina 86

4. Haal de stekker van het apparaat uit het stopcontact.

De stekker van het netsnoer uit het stopcontact trekken of de zekering in de meterkast uitschakelen.

5. Om het ontdooien te versnellen, een pan met heet water op een onderzetter in het vriesvak zetten.

6. Het dooiwater met een zachte doek of een spons opvegen.

7. Het vriesvak met een zachte, droge doek droogwrijven.

8. Het apparaat elektrisch aansluiten.

→ Pagina 85

9. De diepvrieswaren inladen.

→ Pagina 89

---

## 12 Reiniging en onderhoud

Reinig en onderhoud uw apparaat zorgvuldig om er voor te zorgen dat het lang goed blijft werken.

De reiniging van ontoegankelijke plaatsen moet door de servicedienst worden uitgevoerd. Aan de reiniging door de servicedienst kunnen kosten verbonden zijn.

### 12.1 Apparaat voorbereiden voor reiniging

1. Het apparaat uitschakelen.

→ Pagina 86

2. Haal de stekker van het apparaat uit het stopcontact.

De stekker van het netsnoer uit het stopcontact trekken of de zekering in de meterkast uitschakelen.

3. Alle levensmiddelen eruit halen en op een koele plaats bewaren.

Indien beschikbaar koelelementen op de levensmiddelen leggen.

4. Als een rijplaag voorhanden is, deze laten ontdooien.
5. Verwijder alle uitrustingsdelen en accessoires uit het apparaat.  
→ *Pagina 91*

## 12.2 Apparaat schoonmaken

### **WAARSCHUWING** **Kans op elektrische schok!**

Binnendringend vocht kan een schok veroorzaken.

- ▶ Geen stoomreiniger of hogedrukreiniger gebruiken om het apparaat te reinigen.

Vloeistof in de verlichting of in de bedieningselementen kan gevaarlijk zijn.

- ▶ Het afwaswater mag niet in de verlichting of in de bedieningselementen terecht komen.

### **LET OP!**

Ongeschikte reinigingsmiddelen kunnen de oppervlakken van het apparaat beschadigen.

- ▶ Geen harde schuur- of afwaspontjes gebruiken.
- ▶ Geen scherpe of schurende reinigingsmiddelen gebruiken.
- ▶ Geen sterk alcoholhoudende reinigingsmiddelen gebruiken.

Wanneer vloeistof in het afvoergat komt, kan de verdampingsschaal overstromen.

- ▶ Het sop mag niet in het afvoergat komen.

Wanneer u uitrustingsdelen en accessoires in de vaatwasser reinigt, kunnen deze vervormen of verkleuren.

- ▶ Nooit uitrustingsdelen en accessoires in de vaatwasser reinigen.

1. Apparaat voorbereiden voor reiniging. → *Pagina 90*
2. Het apparaat, de uitrustingsdelen, de accessoires en de deurafdichtingen met een vaatdoek, lauw water en een beetje pH-neutraal afwasmiddel reinigen.
3. Met een zachte, droge doek grondig nadrogen.
4. De uitrustingsdelen plaatsen.
5. Het apparaat elektrisch aansluiten.  
→ *Pagina 85*
6. Doe de levensmiddelen in het apparaat.

## 12.3 De dooiwatergoot en het afvoergat reinigen.

Reinig de dooiwatergoot en het afvoergat regelmatig, om ervoor te zorgen dat het dooiwater kan weglopen.

- ▶ Reinig de dooiwatergoot en het afvoergat voorzichtig, bijv. met een wattenstaafje.

→ *Fig. 5*

## 12.4 Onderdelen eruit halen

Neem wanneer u de uitrustingsdelen grondig wilt reinigen deze uit het apparaat.

### **Plateau verwijderen**

- ▶ Het plateau aan de voorzijde optillen ①, er uit trekken en verwijderen ②.

→ *Fig. 6*

### **Klep van het vriesvak verwijderen**

- ▶ De klep van het vriesvak openen en van de houder losmaken.

→ *Fig. 7*

## Deurrek verwijderen

- ▶ Het deurrek omhoog tillen en verwijderen.  
→ Fig. 8

## Groente- en fruitlade verwijderen

1. De fruit- en groentelade tot de aanslag uittrekken.
2. Til de fruit- en groentelade aan de voorzijde op ① en verwijder deze ②.  
→ Fig. 9

## 13 Storingen verhelpen

Kleinere storingen aan het apparaat kunt u zelf verhelpen. Raadpleeg voordat u contact opneemt met de klantenservice de informatie over het verhelpen van storingen. Zo voorkomt u onnodige kosten.

### WAARSCHUWING

#### Kans op elektrische schok!

Ondeskundige reparaties zijn gevaarlijk.

- ▶ Alleen daarvoor geschoold vakpersoneel mag reparaties aan het apparaat uitvoeren.
- ▶ Er mogen uitsluitend originele reserveonderdelen worden gebruikt voor reparatie van het apparaat.
- ▶ Als het netsnoer van dit apparaat beschadigd raakt, moet het ter vermindering van risico's worden vervangen door de fabrikant, de servicedienst of een andere gekwalificeerde persoon.

Storing	Oorzaak en probleemoplossing
Apparaat koelt niet, indicaties en verlichting branden.	Het presentatielicht is ingeschakeld. <ul style="list-style-type: none"> <li>▶ Voer de apparaatzelftest uit. → <i>Pagina 95</i></li> <li>✓ Na het verstrijken van de apparaatzelftest gaat het apparaat weer over op normale werking.</li> </ul>
LED-verlichting functioneert niet.	Verschillende oorzaken zijn mogelijk. <ul style="list-style-type: none"> <li>▶ Neem contact op met de servicedienst.</li> </ul> Het nummer van de servicedienst vindt u in het bijgevoegde overzicht van servicediensten.
Temperatuur wijkt erg af van de instelling.	Verschillende oorzaken zijn mogelijk. <ol style="list-style-type: none"> <li>1. Schakel het apparaat uit. → <i>Pagina 86</i></li> <li>2. Schakel het apparaat na ca. 5 minuten opnieuw in. → <i>Pagina 86</i> <ul style="list-style-type: none"> <li>– Als de temperatuur te hoog is, controleer dan de temperatuur na een paar uur opnieuw.</li> <li>– Als de temperatuur te laag is, controleer de temperatuur dan de volgende dag opnieuw.</li> </ul> </li> </ol>
Bodem van het koelvak is nat.	De dooiwatergoot of het afvoergat is verstopt. <ul style="list-style-type: none"> <li>▶ De dooiwatergoot en het afvoergat reinigen. → <i>Pagina 91</i></li> </ul>
Het apparaat borrelt, zoemt of gorgelt of klikt.	Geen storing. Een motor draait, bijv. koelaggregaat, ventilator. Er stroomt koudemiddel door de buizen. Motor, schakelaars of magneetventielen schakelen in- of uit. Geen handeling vereist. Geen handeling vereist.

<b>Storing</b>	<b>Oorzaak en probleemoplossing</b>
Apparaat produceert geluiden.	Uitrustingsdelen wiebelen of klemmen. ▶ Controleer de uitneembare uitrustingsdelen en zet ze eventueel opnieuw in het apparaat.
	Flessen of containers raken elkaar. ▶ Haal flessen of containers van elkaar.
	Super-functie is ingeschakeld. Geen handeling vereist. Geen handeling vereist.

## 13.1 Stroomuitval

Tijdens een stroomuitval stijgt de temperatuur in het apparaat, hierdoor verkort de bewaartijd en de kwaliteit van de diepvriesproducten vermindert.

Op onze website van uw apparaat vindt in de technische gegevens de bewaartijd van de diepvriesproducten in geval van een storing.

### Opmerkingen

- Het apparaat tijdens een stroomuitval zo weinig mogelijk openen en geen andere levensmiddelen inruimen.
- De kwaliteit van de levensmiddelen onmiddellijk na de stroomuitval controleren.
  - Diepvriesproducten die ontdooit en warmer dan 5 °C zijn, weggoien.
  - Licht ontdooide diepvriesproducten koken of bakken en ofwel verbruiken of opnieuw invriezen.

## 13.2 Apparaatzelftest uitvoeren

1. Het apparaat uitschakelen.  
→ *Pagina 86*
  2. Haal de stekker van het apparaat uit het stopcontact.  
De stekker van het netsnoer uit het stopcontact trekken of de zekering in de meterkast uitschakelen.
  3. Het apparaat na 5 minuten opnieuw elektrisch aansluiten.  
→ *Pagina 85*
  4. Binnen 10 seconden na het inschakelen de temperatuurinstelknop gedurende 5 tot 7 seconden ingedrukt houden, tot een tweede akoestische signaal klinkt.
- ✓ De apparaatzelftest start.

- ✓ Tijdens de apparaatzelftest weerklinkt tussendoor een lang akoestisch signaal.
- ✓ Als na het einde van de apparaatzelftest 2 akoestische signalen weerklinken en Super twee keer knippert, is uw apparaat in orde. Het apparaat gaat over op de normale werking.
- ✓ Als na het einde van de apparaatzelftest 5 akoestische signalen weerklinken en Super gedurende 10 seconden knippert, contact opnemen met de service.

---

## 14 Opslaan en afvoeren

Hier krijgt u uitleg over de manier waarop u het apparaat voorbereidt voor de opslag. Daarnaast leggen we u uit hoe u oude apparaten dient af te voeren.

### 14.1 Apparaat buiten gebruik stellen

1. Het apparaat uitschakelen.  
→ *Pagina 86*
2. Haal de stekker van het apparaat uit het stopcontact.  
De stekker van het netsnoer uit het stopcontact trekken of de zekering in de meterkast uitschakelen.
3. Alle levensmiddelen verwijderen.
4. Het apparaat ontdooien.  
→ *Pagina 90*
5. Het apparaat reinigen.  
→ *Pagina 91*
6. Om de ventilatie van het interieur te waarborgen het apparaat geopend laten.

## 14.2 Afvoeren van uw oude apparaat

Door een milieuvriendelijke afvoer kunnen waardevolle grondstoffen opnieuw worden gebruikt.

### **WAARSCHUWING**

#### **Kans op gevaar voor de gezondheid!**

Kinderen kunnen zich in het apparaat opsluiten en in levensgevaar geraken.

- ▶ Om te voorkomen dat kinderen in het apparaat kruipen legplateaus en lades niet uit het apparaat nemen.
- ▶ Kinderen uit de buurt van een afgedankt apparaat houden.

### **WAARSCHUWING**

#### **Kans op brand!**

Bij beschadiging van de leidingen kunnen brandbaar koudemiddel en schadelijke gassen ontsnappen en ontsteken.

- ▶ De buizen van de koudemiddelkringloop en de isolatie niet beschadigen.
1. De stekker van het netsnoer uit het stopcontact trekken.
  2. Het netsnoer doorknippen.
  3. Voer het apparaat milieuvriendelijk af.

Bij uw dealer en uw gemeente- of deelraadskantoor kunt u informatie verkrijgen over de actuele afvoermethoden.



Dit apparaat is gekenmerkt in overeenstemming met de Europese richtlijn 2012/19/EU betreffende afgedankte elektrische en elektroni-

sche apparatuur (waste electrical and electronic equipment - WEEE).

De richtlijn geeft het kader aan voor de in de EU geldige terugneming en verwerking van oude apparaten.

---

## 15 Servicedienst

Als u vragen hebt, een storing aan het apparaat niet zelf kunt verhelpen of als het apparaat moet worden gerepareerd, neem dan contact op met onze servicedienst.

Originele vervangende onderdelen die relevant zijn voor de werking in overeenstemming met de desbetreffende Ecodesign-verordening kunt u voor de duur van ten minste 10 jaar vanaf het moment van in de handel brengen van het apparaat binnen de Europese Economische Ruimte bij onze servicedienst verkrijgen.

**Opmerking:** Het inschakelen van de servicedienst is in het kader van de plaatselijk geldende fabrieksgarantievoorwaarden gratis. De minimumduur van de garantie (fabrieksgarantie voor particuliere gebruikers) in de Europese Economische Ruimte bedraagt 2 jaar in overeenstemming met de geldende plaatselijke garantievoorwaarden. De garantievoorwaarden doen geen afbreuk aan eventuele andere rechten of claims die u op grond van het plaatselijke recht heeft.

Gedetailleerde informatie over de garantieperiode en garantievoorwaarden in uw land kunt u opvragen bij onze servicedienst, uw dealer of op onze website.



Als u contact opneemt met de servicedienst, hebt u het productnummer (E-Nr.) en het productienummer (FD) van het apparaat nodig.

De contactgegevens van de servicedienst vindt u in de meegeleverde servicedienstlijst of op onze website.

## **15.1 Productnummer (E-nr.) en productienummer (FD)**

Het productnummer (E-Nr.) en het productienummer (FD) vindt u op het typeplaatje van het apparaat.

→ Fig. 1/4

Om uw apparaatgegevens en de servicedienst-telefoonnummers snel terug te kunnen vinden, kunt u de gegevens noteren.

---

## **16 Technische gegevens**

Koudemiddel, netto inhoud en overige technische gegevens bevinden zich op het typeplaatje.

→ Fig. 1/4

Dit product bevat een lichtbron van energieklasse E. De lichtbron is leverbaar als reserveonderdeel en mag uitsluitend door een hiervoor getrainde monteur worden vervangen.

Meer informatie over uw model vindt u op het internet onder

<https://eprel.ec.europa.eu/><sup>1</sup>. Dit webadres verwijst naar de officiële EU-productdatabank EPREL. Volg dan de aanwijzingen bij het zoeken naar het model op. De modelidentificatie bestaat uit het teken voor de slash van het E-nummer (E-Nr.) op het typeplaatje. Alternatief vindt u de modelidentificatie ook in de eerste regel van het EU-energielabel.

---

<sup>1</sup> Geldt alleen voor landen in de Europese Economische Ruimte





A series of horizontal lines for writing, starting from the top right of the pencil icon and extending across the page.



BSH Hausgeräte GmbH  
Carl-Wery-Straße 34  
81739 München, GERMANY



REGISTER YOUR PRODUCT  
ONLINE [NEFF-HOME.COM](http://NEFF-HOME.COM)







**9001715343**  
de, fr, it, nl  
020209

# SELF-REPAIR HINTS

[bg]	Съвети за ремонт .....	2
[hr]	Savjeti za popravak .....	18
[cs]	Poznámky k opravě .....	34
[da]	Tip til reparation .....	50
[nl]	Reparatie informatie .....	66
[en]	Self-repair hints .....	82
[et]	Remonditeave .....	98
[fi]	Korjausvinkit .....	114
[fr]	Conseils de réparation .....	130
[de]	Reparatur Hinweise .....	146
[el]	Υποδείξεις επισκευής .....	162
[hu]	Javítási útmutató .....	178
[it]	Consigli di riparazione .....	194
[lv]	Informācija par remontu .....	210
[lt]	Informacija apie remontą .....	226
[no]	Reparasjonstips .....	242
[pl]	Wskazówki naprawy .....	258
[pt]	Dicas de resolução .....	274
[ro]	Indicii pentru reparații .....	290
[sk]	Poznámky k opravám .....	306
[sl]	Nasveti za popravilo .....	322
[es]	Consejos de reparación .....	338
[sv]	Reparationsinformation .....	354
[tr]	Onarım İpuçları .....	370

# Съвети за ремонт - Хладилник

 <b>Относно този документ</b> .....	<b>3</b>
1.1 Важна информация.....	3
1.1.1 Цел.....	3
1.2 Обяснение на символите.....	3
1.2.1 Нива на опасност.....	3
1.2.2 Символи за опасност.....	3
1.2.3 Структура на предупрежденията.....	4
1.2.4 Общи символи.....	4
 <b>Безопасност</b> .....	<b>5</b>
2.1 Общи инструкции за безопасност.....	5
2.1.1 Всички домашни уреди.....	5
 <b>Инструменти и помощни средства</b> .....	<b>6</b>
 <b>Ремонт</b> .....	<b>7</b>
4.1 Смяна на уплътнителя на вратата.....	7
4.1.1 Сваляне на уплътнителя на вратата.....	7
4.1.2 Монтиране на уплътнителя на вратата.....	7
4.2 Смяна на плоска панта.....	10
4.2.1 Сваляне на плоската панта.....	10
4.2.2 Монтиране на плоска панта.....	11
4.3 Смяна на плъзгащата се панта.....	12
4.3.1 Сваляне на плъзгащата се панта.....	12
4.3.2 Монтиране на плъзгащата се панта.....	12
4.4 Смяна на рафта.....	13
4.4.1 Изваждане на рафта.....	13
4.4.2 Монтиране на рафта.....	13
4.5 Смяна на стелажа на вратата.....	14
4.5.1 Изваждане на стелажа на вратата.....	14
4.5.2 Монтиране на стелажа на вратата.....	14
4.6 Смяна на контейнера за плодове и зеленчуци.....	15
4.6.1 Изваждане на контейнера за плодове и зеленчуци.....	15
4.6.2 Монтиране на контейнера за плодове и зеленчуци.....	15
4.7 Смяна на страничната LED светлина.....	16
4.7.1 Сваляне на страничната LED лампа.....	16
4.7.2 Монтиране на страничната LED лампа.....	17

# **i** Относно този документ

## 1.1 Важна информация

### 1.1.1 Цел

Тези съвети за ремонт помагат на потребителя да ремонтира сам уреди в съответствие с регламента за екологосъобразно проектиране на уредите (от 03.2021 г.).

Те съдържат информация как да сменят определени резервни части, включително предупреждения и рискове.

Ако имате някакви въпроси, моля свържете се с нашия отдел за обслужване на клиенти. Носим отговорност за щети, само ако съветите за ремонт са спазени правилно.

## 1.2 Обяснение на символите

### 1.2.1 Нива на опасност

Предупредителните нива се състоят от символ и сигнална дума. Сигналната дума показва сериозността на опасността.





Ниво на предупреждение	Значение
	Неспазването на предупредителното съобщение ще доведе до смърт или сериозни наранявания.
	Неспазването на предупредителното съобщение може да доведе до смърт или сериозни наранявания.
	Неспазването на предупредителното съобщение може да доведе до леки наранявания.
	Неспазването на предупредителното съобщение може да доведе до имуществени щети.

Таблица 1: Нива на опасност

### 1.2.2 Символи за опасност

Символите за опасност са символични изображения, които дават индикация за вида опасност.

В този документ се използват следните символи за опасност:

Символ за опасност	Значение
	Общо предупредително съобщение
	Опасност от електрическо напрежение
	Риск от експлозия
	Опасност от порязвания

## **i** Относно този документ





Символ за опасност	Значение
	Опасност от премазване
	Опасност от горещи повърхности
	Опасност от силно магнитно поле
	Опасност от нейонизиращо лъчение

Таблица 2: Символи за опасност

### 1.2.3 Структура на предупрежденията

Предупрежденията в този документ имат стандартизиран външен вид и стандартизирана структура.

	<p><b>ОПАСНОСТ</b></p> <p><b>Вид и източник на опасността!</b> Възможни последици от игнориране на опасността/предупреждението.</p> <ul style="list-style-type: none"> <li>▶ Мерки и забрани за предотвратяване на опасността.</li> </ul>
--	---

Следният пример показва предупреждение, което уведомява за токов удар, предизвикан от части под напрежение. Споменава се мярката за избягване на опасността.

	<p><b>ОПАСНОСТ</b></p> <p><b>Риск от токов удар поради части под напрежение!</b> Смърт от токов удар</p> <ul style="list-style-type: none"> <li>▶ Изключете уредите от електрическото захранване поне 60 секунди преди започване на ремонта.</li> </ul>
--	---

### 1.2.4 Общи символи

В този документ се използват следните общи символи:







Общ символ	Значение
	Идентифициране на специален съвет (текст и/или графика)
	Идентифициране на прост съвет (само текст)
	Идентифициране на връзка към видео урок
	Идентифициране на необходимите инструменти
	Идентифициране на необходимите предварителни условия
	Идентифициране на условие (ако ..., тогава ...)
	Идентифициране на резултат
Старт	Идентифициране на ключ или бутон
[00123456]	Идентифициране на каталожен номер
Статус	Идентифициране на показания текст/прозорец (на дисплея на уреда)

Таблица 3: Общи символи



## **2.1 Общи инструкции за безопасност**

### **2.1.1 Всички домашни уреди**

#### **Риск от токов удар поради части под напрежение!**

- Грешки при ремонти, включващи електрически компоненти, могат да доведат до токов удар!
- Разкачете уреда от електрическата мрежа за поне 60 секунди, преди да започнете работа.
- След ремонта трябва да се извърши проверка за безопасност съгласно VDE 0701 или в съответствие със специфичните за страната разпоредби.

#### **Риск от нараняване от остри ръбове!**

- Носете предпазни ръкавици.

#### **Риск от премазване по време на ремонт, поддръжка, отстраняване на неизправности и сервиз поради тежки и движещи се компоненти**

- Носете защитни обувки.
- Закрепете тежките компоненти, така че да не паднат.
- Не позволявайте контакт на части от тялото с движещи се компоненти.

#### **Риск за безопасността/функцията на уреда!**

- Използвайте само оригинални резервни части.

#### **Риск от повреда на електростатично чувствителни компоненти (ESD)!**

- Не докосвайте модулите, включително връзки и проводникови пътища.

## Инструменти и помощни средства

посочване	Подробности	Изображения
Защитна кърпа [00342013]	60 см x 50 см	
Смукателна чаша [00342224]	Ø50 мм	
Накрайник Torx TX20 [00340865]	6,3 мм (1/4")	

## 4.1 Смяна на уплътнителя на вратата

### Изискване:

- ✔ Вратата е отворена.

### 4.1.1 Сваляне на уплътнителя на вратата

1. Освободете уплътнителя на вратата от жлеба отляво и отдясно.

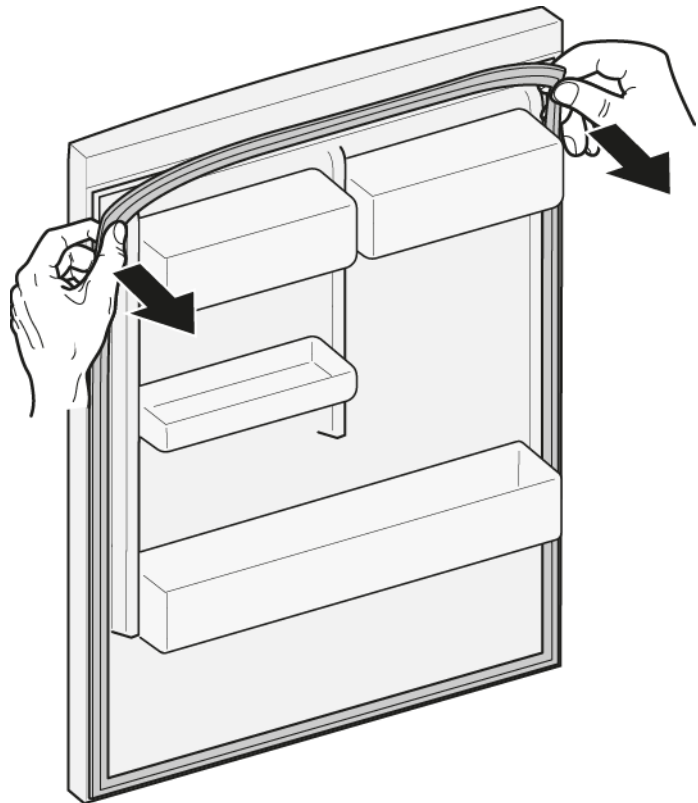

2. Извадете уплътнителя на вратата от жлеба.

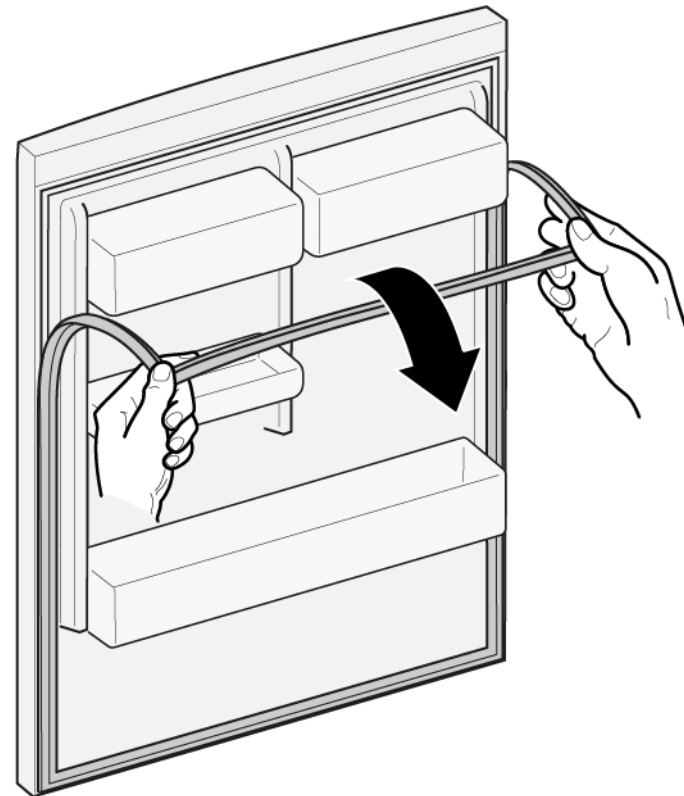

- ➡ Уплътнителят на вратата е свален.

### 4.1.2 Монтиране на уплътнителя на вратата



Дебелината на новия уплътнител на вратата може леко да се отличава от тази на стария уплътнител. Това няма да повлияе на начина на затваряне и нейната работа в дългосрочен план.

Ако вашият уред има регулируеми панти или приставки за панти, можете да оптимизирате начина на затваряне по-късно.

Малките странични отвори в уплътнителя на вратата са функционални (необходими за вентилация). Те не са производствени грешки.

1. Проверете жлеба на уплътнителя за повреди.



4. Натиснете ъглите на уплътнителя отгоре и отдолу към жлеба.

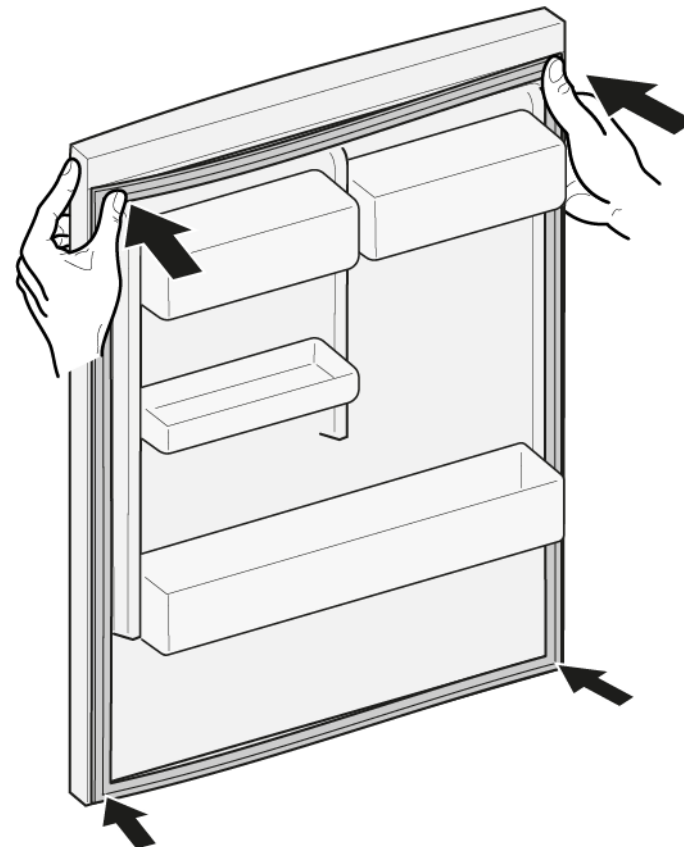



2.  Ако жлебът на уплътнителя е повреден:  
- Свържете се с отдела за обслужване на клиенти.

3.  Леката деформация на уплътнителя на вратата е нормална и не засяга неговата функция. Препоръчително е да изправите уплътнителя на вратата, преди да го поставите в уреда.

Загрейте уплътнителя на вратата със сешоар или гореща вода и променете формата му.

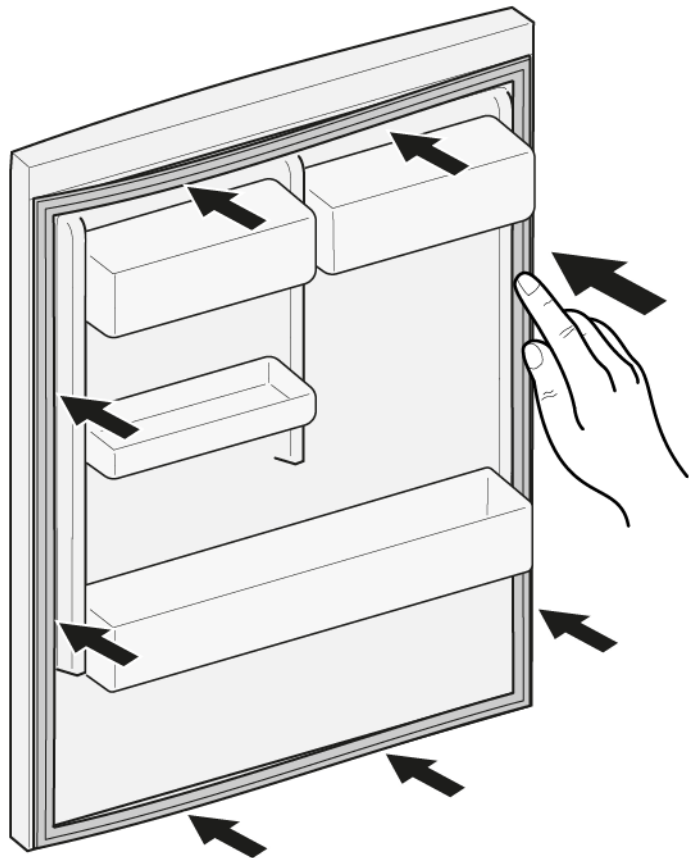
5. Постепенно вкарайте с натискане целия уплътнител в жлеба.





-  Уплътнителят на вратата е монтиран.

## 4.2 Смяна на плоска панта

Специални инструменти:

 Накрайник Torx TX20      6,3 мм (1/4")      [00340865]

	<b>⚠ ПРЕДУПРЕЖДЕНИЕ</b>
	<p><b>Тежки, обемисти уреди!</b> Травми на гърба и мускулите</p> <ul style="list-style-type: none"> <li>▶ Операцията по отстраняване на вратите на уреда трябва да се извършва само от обучени специалисти.</li> <li>▶ За преместването на уреда са необходими двама души.</li> <li>▶ Използвайте само подходящи инструменти и оборудване.</li> </ul>



	<b>⚠ ВНИМАТЕЛНО</b>
	<p><b>Остри ръбове!</b> Наранявания от порязване</p> <ul style="list-style-type: none"> <li>▶ Носете предпазни ръкавици.</li> </ul>

	<b>⚠ ВНИМАТЕЛНО</b>
	<p><b>Отворете областта на пантите!</b> Премазване/захващане на пръстите</p> <ul style="list-style-type: none"> <li>▶ Не посягайте към областта на пантите.</li> <li>▶ Носете предпазни ръкавици.</li> </ul>

	<b>⚠ ВНИМАТЕЛНО</b>
	<p><b>Риск от падащи части поради разхлабени винтове!</b> Нараняване поради падащи части.</p> <ul style="list-style-type: none"> <li>▶ Закрепете компонента, така че да не падне.</li> </ul>

	<b>ВНИМАНИЕ!</b>
	<p><b>Риск от падащи части поради разхлабени винтове!</b> Повреда на други части на уреда или в дома на клиента, напр. дъното.</p> <ul style="list-style-type: none"> <li>▶ Закрепете компонента, така че да не падне.</li> </ul>

Изискване:

-  Уредът е изключен от захранването.
-  Мебелната врата е свалена. Вижте "Инструкция за монтаж".
-  Вратата е отворена.

### 4.2.1 Сваляне на плоската панта



1. Отстранете двете капачета на пантите.

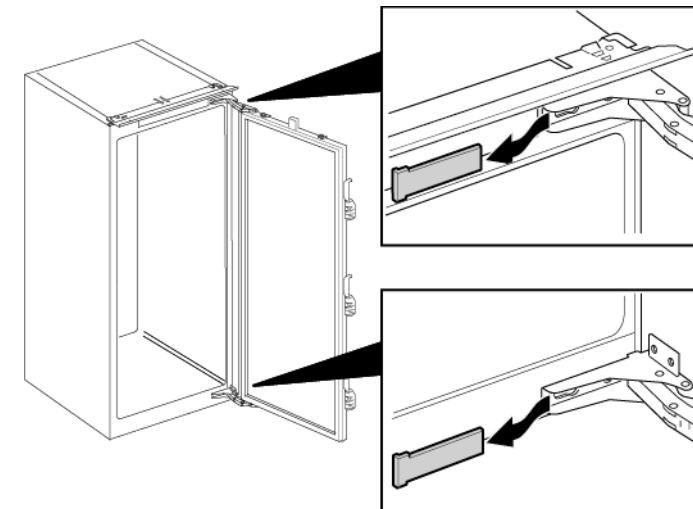

2. 1. Разхлабете четирите винта (1).
2. Плъзнете навън и свалете вратата (2).

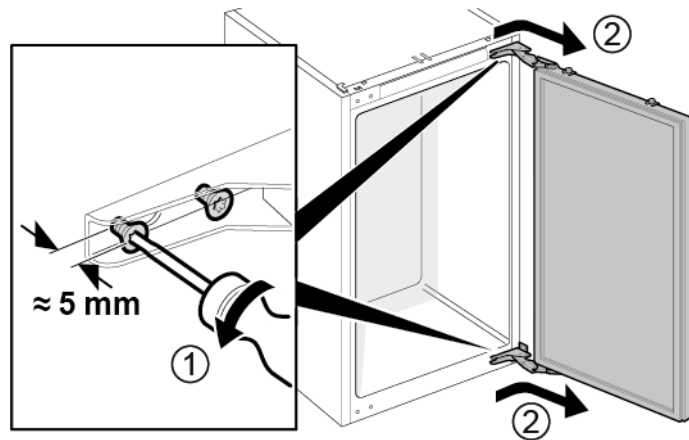

3. 1. Свалете четирите винта (1).
2. Свалете пантите (2).

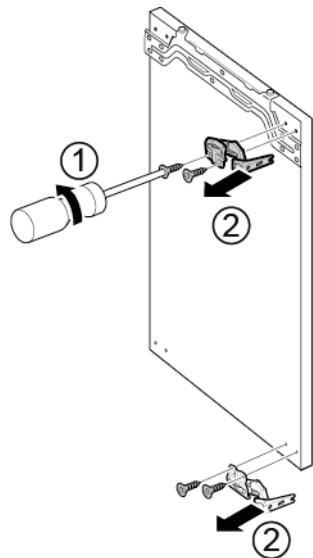

 Пантите са свалени.

## 4.2.2 Монтиране на плоска панта

- ▶ Монтирайте в обратен ред.

### 4.3 Смяна на плъзгащата се панта

Специални инструменти:

 Накрайник Torx TX20      6,3 мм (1/4")      [00340865]



	<b>⚠ ПРЕДУПРЕЖДЕНИЕ</b>
	<p><b>Тежки, обемисти уреди!</b> Травми на гърба и мускулите</p> <ul style="list-style-type: none"> <li>▶ Операцията по отстраняване на вратите на уреда трябва да се извършва само от обучени специалисти.</li> <li>▶ За преместването на уреда са необходими двама души.</li> <li>▶ Използвайте само подходящи инструменти и оборудване.</li> </ul>

	<b>⚠ ВНИМАТЕЛНО</b>
	<p><b>Остри ръбове!</b> Наранявания от порязване</p> <ul style="list-style-type: none"> <li>▶ Носете предпазни ръкавици.</li> </ul>

	<b>⚠ ВНИМАТЕЛНО</b>
	<p><b>Риск от падащи части поради разхлабени винтове!</b> Нараняване поради падащи части.</p> <ul style="list-style-type: none"> <li>▶ Закрепете компонента, така че да не падне.</li> </ul>

	<b>ВНИМАНИЕ!</b>
	<p><b>Риск от падащи части поради разхлабени винтове!</b> Повреда на други части на уреда или в дома на клиента, напр. дъното.</p> <ul style="list-style-type: none"> <li>▶ Закрепете компонента, така че да не падне.</li> </ul>

Изискване:

-  Уредът е изключен от захранването.
-  Мебелната врата и вратата на уреда са разделени. Вижте "Инструкция за монтаж".

#### 4.3.1 Сваляне на плъзгащата се панта

- ▶ 1. Развийте двата винта (1).
- ▶ 2. Свалете горната панта (2).
- ▶ 3. Извадете вратата (3).
- ▶ 4. Развийте двата винта (4).
- ▶ 5. Свалете долната панта (5).

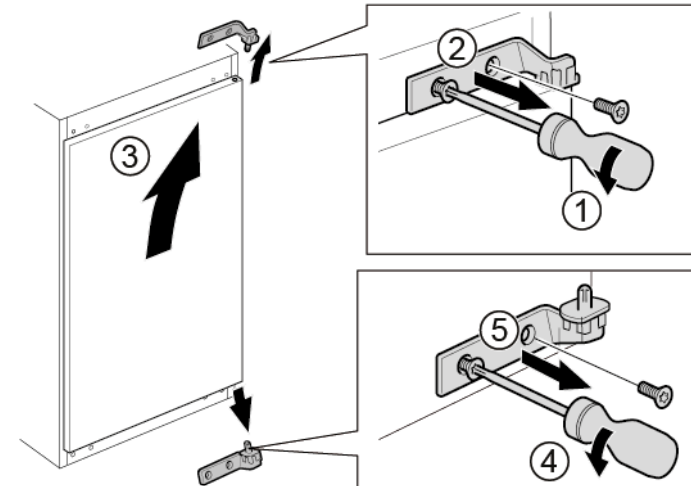

 Пантите са свалени.

#### 4.3.2 Монтиране на плъзгащата се панта

- ▶ Монтирайте в обратен ред.



## 4.4 Смяна на рафта

### Изискване:

- ✔ Вратата е отворена.

### 4.4.1 Изваждане на рафта

- ▶ Издърпайте рафта.

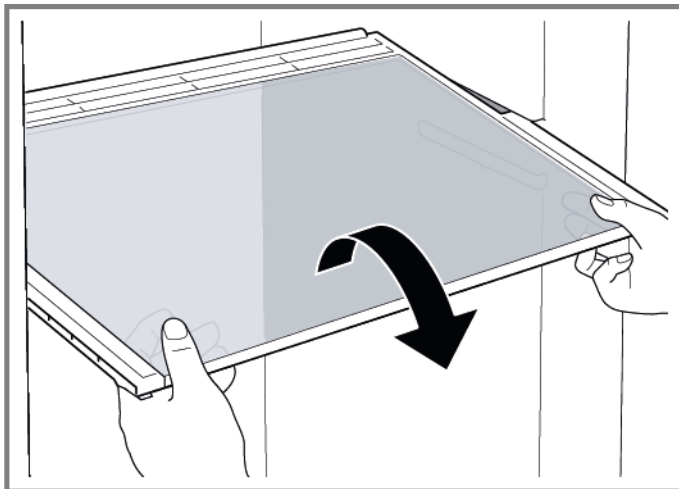

- ➡ Рафтът е свален.

### 4.4.2 Монтиране на рафта

- ▶ Монтирайте в обратен ред.

## 4.5 Смяна на стелажа на вратата

Изискване:

- ✔ Вратата е отворена.

### 4.5.1 Изваждане на стелажа на вратата

- ▶ Повдигнете стелажа на вратата нагоре.

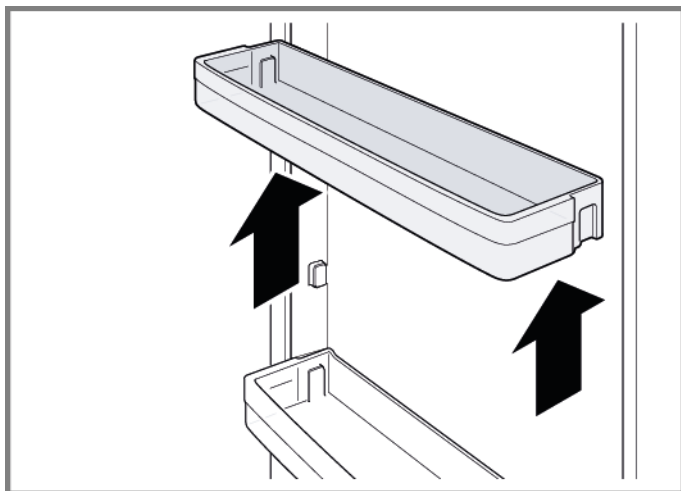

- ➡ Стелажът на вратата е свален.

### 4.5.2 Монтиране на стелажа на вратата

- ▶ Монтирайте в обратен ред.

## 4.6 Смяна на контейнера за плодове и зеленчуци

### Изискване:

- ✔ Вратата е отворена.

### 4.6.1 Изваждане на контейнера за плодове и зеленчуци

1. Издърпайте контейнера за плодове и зеленчуци докъдето може да стигне.
2. 1. Повдигнете контейнера за плодове и зеленчуци в предната част (1).  
2. Извадете контейнера (2).



- ➡ Контейнерът за плодове и зеленчуци е отстранен.

### 4.6.2 Монтиране на контейнера за плодове и зеленчуци

- ▶ Монтирайте в обратен ред.

## 4.7 Смяна на страничната LED светлина

### Специални инструменти:

 Смукателна чаша      Ø50 мм      [00342224]



	<p>Вашият уред е снабден с LED осветление, което не изисква поддръжка.</p> <p>Това осветление може да бъде ремонтирано само от специалисти от службата за обслужване на клиенти или от квалифицирани техници!</p>
---	---

	<b>⚠ ОПАСНОСТ</b>
	<p><b>Риск от токов удар поради части под напрежение!</b></p> <p>Опасност за живота от токов удар в случай на неправилен ремонт</p> <ul style="list-style-type: none"> <li>▶ Електрическите части трябва да се ремонтират от квалифицирани електротехници.</li> <li>▶ След ремонта трябва да се извърши проверка за безопасност съгласно VDE 0701 или в съответствие със специфичните за страната разпоредби.</li> </ul>

	<b>⚠ ОПАСНОСТ</b>
	<p><b>Риск от токов удар поради части под напрежение!</b></p> <p>Смърт от токов удар</p> <ul style="list-style-type: none"> <li>▶ Изключете уредите от електрическото захранване поне 60 секунди преди започване на ремонта.</li> </ul>

	<b>⚠ ВНИМАТЕЛНО</b>
	<p><b>Остри ръбове!</b></p> <p>Наранявания от порязване</p> <ul style="list-style-type: none"> <li>▶ Носете предпазни ръкавици.</li> </ul>

### Изискване:

-  Уредът е изключен от захранването.
-  Вратата е отворена.
-  Рафтовете са извадени.

### 4.7.1 Сваляне на страничната LED лампа

1. Поставете две смукателни чаши върху капака на страничната LED светлина.

2. Издърпайте смукателните чаши напред с едно въртеливо движение.

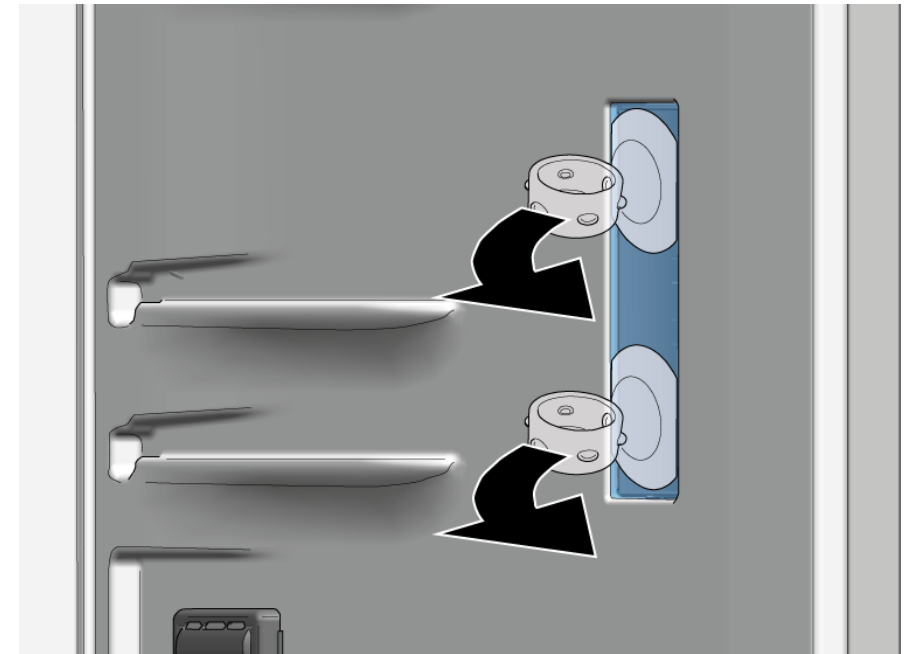

 Капакът на LED лампата е свален.

3. Свалете LED модула.

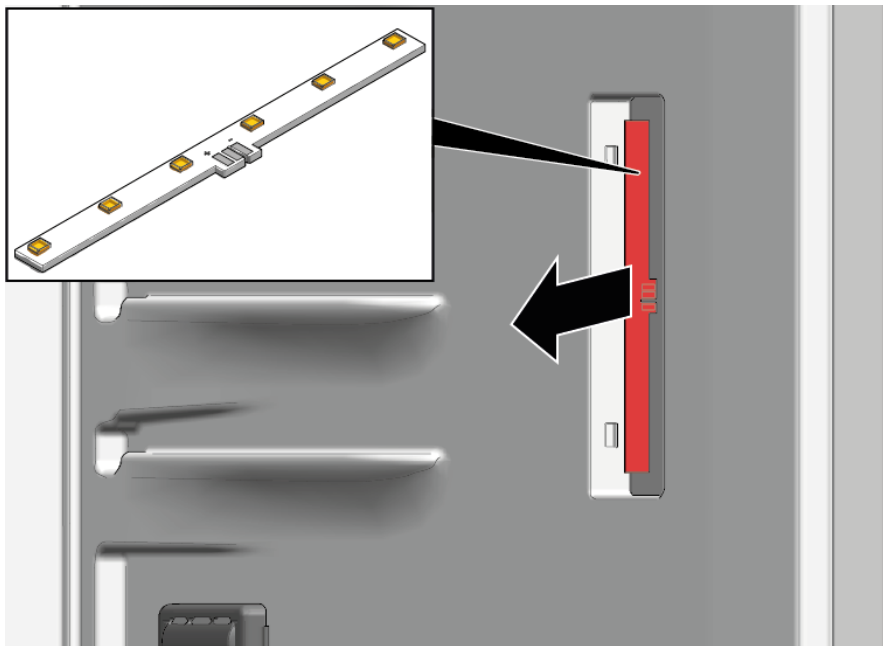

 Страничната LED лампа е свалена.





#### 4.7.2 Монтиране на страничната LED лампа



Поради възможността куките на капака на лампата да се счупят по време на свалянето, резервната странична LED лампа е комплект, който включва LED модул и капак.

► Монтирайте в обратен ред.

# Savjeti za popravak - Hladnjak

 <b>O ovom dokumentu</b> .....	<b>19</b>
1.1 Važne informacije .....	19
1.1.1 Svrha .....	19
1.2 Objašnjenje oznaka .....	19
1.2.1 Stupnjevi opasnosti .....	19
1.2.2 Oznake opasnosti .....	19
1.2.3 Struktura upozorenja .....	20
1.2.4 Opće oznake .....	20
 <b>Sigurnost</b> .....	<b>21</b>
2.1 Opće sigurnosne upute .....	21
2.1.1 Svi kućanski uređaji .....	21
 <b>Alat i pomagala</b> .....	<b>22</b>
 <b>Popravak</b> .....	<b>23</b>
4.1 Zamjena brtve vrata.....	23
4.1.1 Uklanjanje brtve vrata.....	23
4.1.2 Postavljanje brtve vrata .....	23
4.2 Zamjena ravnog zgloba.....	26
4.2.1 Uklanjanje ravnog zgloba .....	26
4.2.2 Postavljanje ravnog zgloba .....	27
4.3 Zamjena kliznog zgloba .....	28
4.3.1 Uklanjanje kliznog zgloba .....	28
4.3.2 Postavljanje kliznog zgloba .....	28
4.4 Zamjena police .....	29
4.4.1 Uklanjanje police.....	29
4.4.2 Postavljanje police .....	29
4.5 Zamjena posude za vrata.....	30
4.5.1 Uklanjanje posude za vrata.....	30
4.5.2 Postavljanje posude za vrata .....	30
4.6 Zamjena spremnika za voće i povrće .....	31
4.6.1 Uklanjanje spremnika za voće i povrće .....	31
4.6.2 Postavljanje spremnika za voće i povrće .....	31
4.7 Zamjena bočnog LED svjetla.....	32
4.7.1 Uklanjanje bočnog LED svjetla.....	32
4.7.2 Postavljanje bočnog LED svjetla .....	33

# **i** O ovom dokumentu

## 1.1 Važne informacije

### 1.1.1 Svrha

Ove upute za popravak služe kao podrška korisnicima prilikom samostalnog popravljivanja uređaja u skladu s primjenjivom Direktivom o ekološkom dizajnu (od ožujka 2021.).

One sadrže informacije o zamjeni određenih rezervnih dijelova, kao i napomene o upozorenjima i opasnostima.

Ako imate dodatna pitanja, obratite se našoj službi za korisnike. Mi snosimo odgovornost za oštećenja samo u slučaju pridržavanja uputa za popravak.

## 1.2 Objašnjenje oznaka

### 1.2.1 Stupnjevi opasnosti

Stupnjevi upozorenja sastoje se od oznake i signalne riječi. Signalna riječ ukazuje na ozbiljnost opasnosti.





Stupanj upozorenja	Značenje
 <b>OPASNOST</b>	Nepridržavanje poruke upozorenja rezultirat će smrtnim ili teškim ozljedama.
 <b>UPOZORENJE</b>	Nepridržavanje poruke upozorenja može rezultirati smrtnim ili teškim ozljedama.
 <b>OPREZ</b>	Nepridržavanje poruke upozorenja može rezultirati lakšim ozljedama.
 <b>POZORI!</b>	Nepridržavanje poruke upozorenja može rezultirati oštećenjem imovine.

Tablica 1: Stupnjevi opasnosti



### 1.2.2 Oznake opasnosti

Oznake opasnosti simbolička su reprezentacija s oznakom vrste opasnosti.

U ovom dokumentu koriste se sljedeće oznake opasnosti:

Oznaka opasnosti	Značenje
	Opća poruka upozorenja
	Opasnost od električnog napona
	Opasnost od eksplozije
	Opasnost od porezotina
	Opasnost od prignječenja

## O ovom dokumentu

Oznaka opasnosti	Značenje
	Opasnost od vrućih površina
	Opasnost od jakog magnetskog polja
	Opasnost od neionizirajućeg zračenja

Tablica 2: Oznake opasnosti

### 1.2.3 Struktura upozorenja

Upozorenja u ovom dokumentu imaju normirani izgled i strukturu.



	<div style="background-color: red; color: white; padding: 2px; text-align: center;"> <b>OPASNOST</b></div> <p><b>Vrsta i izvor opasnosti!</b> Moguće posljedice zanemarivanja opasnosti/upozorenja.</p> <ul style="list-style-type: none"> <li>▶ Mjere i zabrane za sprječavanje opasnosti.</li> </ul>
--	---





Sljedeći primjer pokazuje upozorenje na strujni udar od dijelova koji provode struju. Spominje se mjera za izbjegavanje opasnosti.

	<div style="background-color: red; color: white; padding: 2px; text-align: center;"> <b>OPASNOST</b></div> <p><b>Opasnost od strujnog udara zbog dijelova koji provode struju!</b> Smrt od strujnog udara</p> <ul style="list-style-type: none"> <li>▶ Isključite uređaj iz električnog napajanja najmanje 60 sekundi prije izvođenja popravaka.</li> </ul>
---	--

### 1.2.4 Opće oznake

U ovom dokumentu koriste se sljedeće opće oznake:

Opća znaka	Značenje
	Oznaka posebnog savjeta (tekst i/ili grafika)
	Oznaka jednostavnog savjeta (samo tekst)
	Oznaka veze na videovodič

Opća znaka	Značenje
	Oznaka potrebnog alata
	Oznaka potrebnih preduvjeta
	Oznaka uvjeta (ako ..., tad ...)
	Oznaka rezultata
[Početak]	Oznaka tipke ili gumba
[00123456]	Oznaka broja materijala
Status	Oznaka prikazanog teksta / prozor (na zaslonu uređaja)

Tablica 3: Opće oznake



## 2.1 Opće sigurnosne upute

### 2.1.1 Svi kućanski uređaji

#### **Opasnost od strujnog udara zbog dijelova koji provode struju!**

- Pogreške izazvane popravcima električnih sastavnih dijelova mogu dovesti do strujnog udara!
- Isključite uređaj iz struje na najmanje 60 sekundi prije početka radova.
- Nakon popravka provedite sigurnosni test u skladu s VDE 0701 ili nacionalnim propisima.

#### **Opasnost od ozljeda zbog oštih rubova!**

- Nosite zaštitne rukavice.

#### **Opasnost od prignječenja tijekom izvođenja radova na popravcima, održavanju, rješavanju problema i servisiranju teških i pokretnih sastavnih dijelova**

- Nosite zaštitnu obuću.
- Osigurajte teške sastavne dijelove od pada.
- Nemojte umetati dijelove tijela u pokretne sastavne dijelove.



#### **Opasnost za sigurnost/rad uređaja!**

- Koristite samo originalne rezervne dijelove.

#### **Opasnost od oštećenja elektrostatički osjetljivih sastavnih dijelova (ESD)!**

- Nemojte dodirivati module, uključujući priključke i rute vodiča.

## Alat i pomagala

Oznaka	Pojedinosti	Slike
Zaštitna navlaka [00342013]	60 cm x 50 cm	
Ušisna čašica [00342224]	Ø50 mm	
Nastavak Torx TX20 [00340865]	6,3 mm (1/4")	

## 4.1 Zamjena brtve vrata

### Zahtjev:

-  Vrata su otvorena.

### 4.1.1 Uklanjanje brtve vrata

1. Otpustite brtvu vrata iz utora u desnom i lijevom kutu.

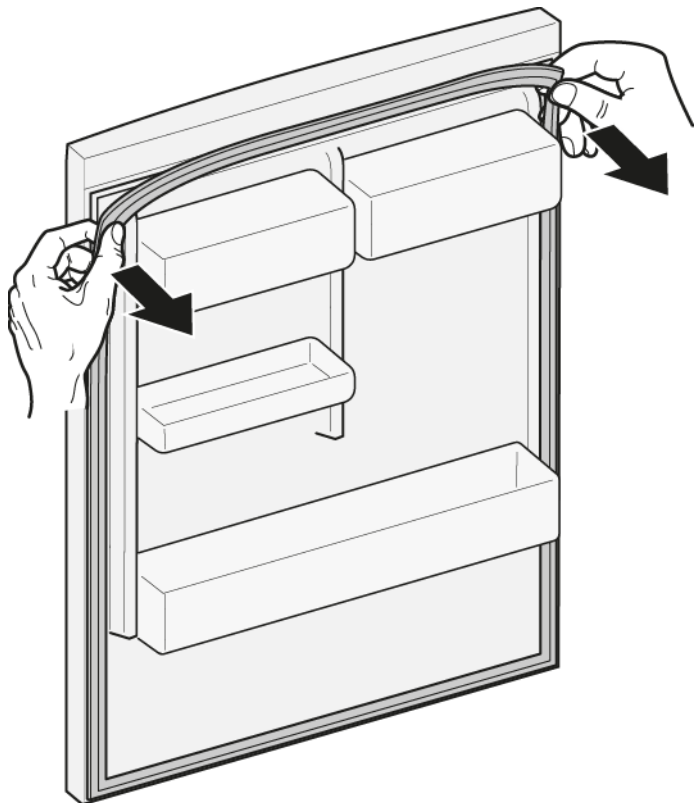

2. Izvucite brtvu vrata iz utora.



-  Brtva vrata je uklonjena.

### 4.1.2 Postavljanje brtve vrata



Debljina nove brtve vrata može malo odstupati od debljine stare brtve vrata. To neće utjecati na zatvaranje i dugoročnu funkciju.

Ako uređaj ima prilagodljive zglobove ili nastavke zglobova, možete dodatno optimizirati zatvaranje.

Mali bočni otvori u brtvi vrata su funkcijski (potrebni za ventilaciju). Nije riječ o proizvodnim pogreškama.

1. Provjerite ima li oštećenja na utoru za brtvu.



4. Gurnite kutove brtve na vrh i dno utora.

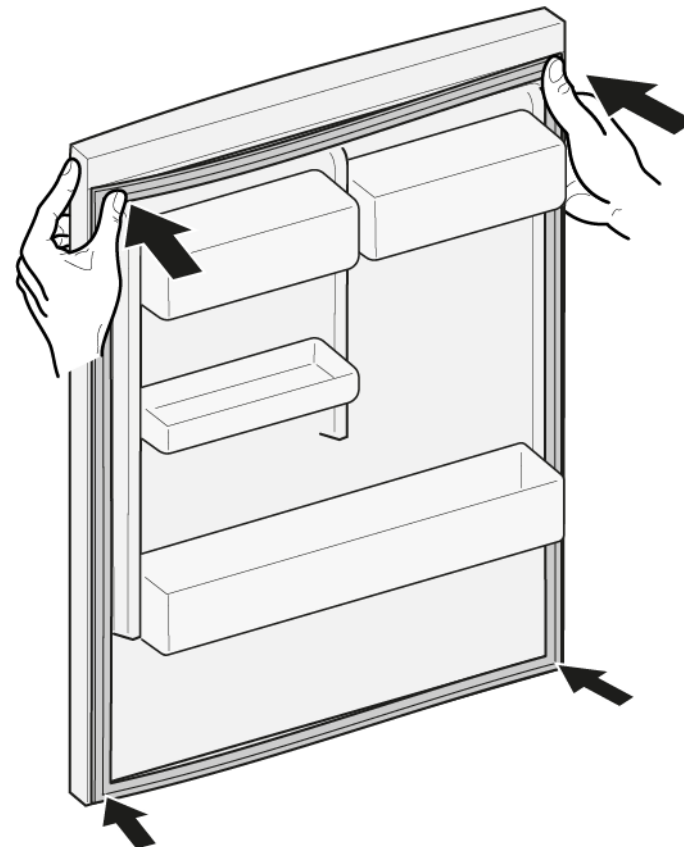

2.  Ako je utor za brtvu oštećen.  
- Obratite se službi za korisnike.

3.  Blago odstupanje brtve vrata normalno je i ne utječe na funkciju. Preporučuje se izravnati brtvu vrata prije umetanja u uređaj.

Zagrijte brtvu vrata sušilom za kosu ili vrućom vodom i ručno je oblikujte.

5. Utisnite cijelu brtvu korak po korak u utor.



-  Brtva vrata je postavljena.

## 4.2 Zamjena ravnog zgloba

### Specijalni alati:

🌀 Nastavak Torx TX20      6,3 mm (1/4")      [00340865]

	<b>⚠️ UPOZORENJE</b>
	<p><b>Teški, veliki uređaji!</b> Ozljede leđa i kralježnice</p> <ul style="list-style-type: none"> <li>▶ Uklanjanje vrata uređaja smiju obavljati samo obučeni stručnjaci.</li> <li>▶ Za pomicanje uređaja potrebne su dvije osobe.</li> <li>▶ Koristite samo prikladan alat i opremu.</li> </ul>

	<b>⚠️ OPREZ</b>
	<p><b>Oštri rubovi!</b> Porezotine</p> <ul style="list-style-type: none"> <li>▶ Nosite zaštitne rukavice.</li> </ul>

	<b>⚠️ OPREZ</b>
	<p><b>Otvorite područje zgloba!</b> Prignječenje/zaglavljivanje prstiju</p> <ul style="list-style-type: none"> <li>▶ Nemojte posezati rukama u područje zgloba.</li> <li>▶ Nosite zaštitne rukavice.</li> </ul>

	<b>⚠️ OPREZ</b>
	<p><b>Opasnost od padanja dijelova zbog otpuštenih vijaka!</b> Ozljeda od dijelova koji padaju.</p> <ul style="list-style-type: none"> <li>▶ Osigurajte sastavne dijelove od pada.</li> </ul>

	<b>POZOR!</b>
	<p><b>Opasnost od padanja dijelova zbog otpuštenih vijaka!</b> Oštećenje drugih dijelova uređaja ili objekta klijenta, npr. poda.</p> <ul style="list-style-type: none"> <li>▶ Osigurajte sastavne dijelove od pada.</li> </ul>

### Zahtjev:

- ✔️ Uređaj je isključen iz napajanja.
- ✔️ Vrata namještaja su uklonjena. Pogledajte upute za postavljanje.
- ✔️ Vrata su otvorena.

## 4.2.1 Uklanjanje ravnog zgloba



1. Uklonite dva poklopca zgloba.

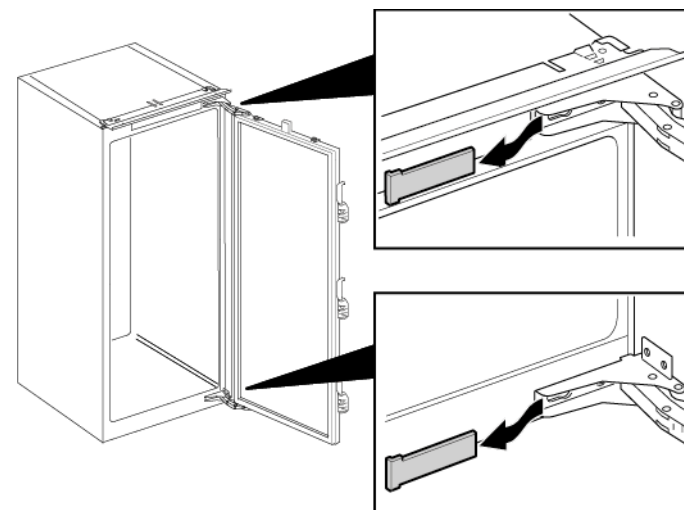

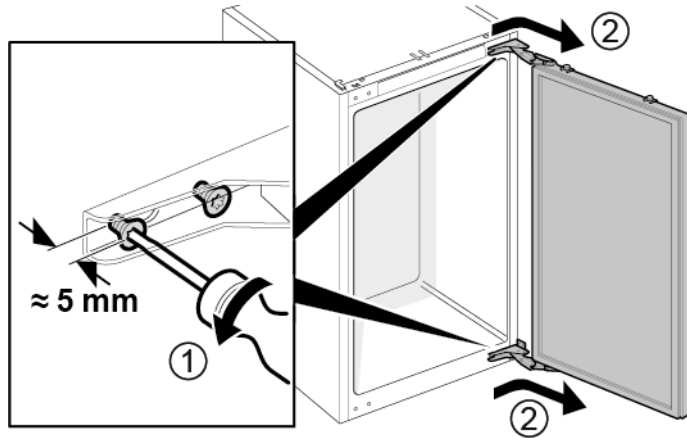

## Popravak

1. Otpustite četiri vijka (1).
2. Gurnite vrata prema van i uklonite ih (2).

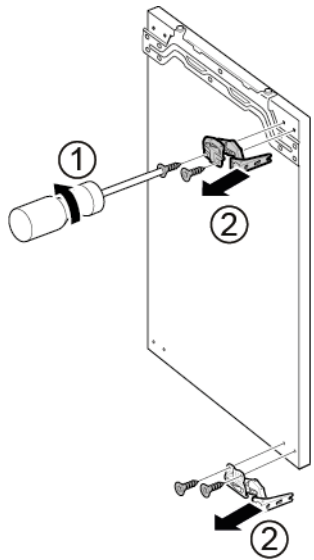

3. 1. Uklonite četiri vijka (1).
2. Uklonite zglobove (2).



 Zglobovi su uklonjeni.

### 4.2.2 Postavljanje ravnog zgloba

- Postavite obratnim redoslijedom.

## 4.3 Zamjena kliznog zgloba

### Specijalni alati:

🔧 Nastavak Torx TX20      6,3 mm (1/4")      [00340865]

	<b>⚠️ UPOZORENJE</b>
	<p><b>Teški, veliki uređaji!</b> Ozljede leđa i kralježnice</p> <ul style="list-style-type: none"> <li>▶ Uklanjanje vrata uređaja smiju obavljati samo obučeni stručnjaci.</li> <li>▶ Za pomicanje uređaja potrebne su dvije osobe.</li> <li>▶ Koristite samo prikladan alat i opremu.</li> </ul>

	<b>⚠️ OPREZ</b>
	<p><b>Oštri rubovi!</b> Porezotine</p> <ul style="list-style-type: none"> <li>▶ Nosite zaštitne rukavice.</li> </ul>

	<b>⚠️ OPREZ</b>
	<p><b>Opasnost od padanja dijelova zbog otpuštenih vijaka!</b> Ozljeda od dijelova koji padaju.</p> <ul style="list-style-type: none"> <li>▶ Osigurajte sastavne dijelove od pada.</li> </ul>

	<b>POZOR!</b>
	<p><b>Opasnost od padanja dijelova zbog otpuštenih vijaka!</b> Oštećenje drugih dijelova uređaja ili objekta klijenta, npr. poda.</p> <ul style="list-style-type: none"> <li>▶ Osigurajte sastavne dijelove od pada.</li> </ul>

### Zahtjev:

- ✔ Uređaj je isključen iz napajanja.
- ✔ Vrata namještaja i vrata uređaja su odvojena. Pogledajte upute za postavljanje.

### 4.3.1 Uklanjanje kliznog zgloba

- ▶ 1. Odvijte dva vijka (1).
- ▶ 2. Uklonite gornji zglob (2).
- ▶ 3. Uklonite vrata (3).
- ▶ 4. Odvijte dva vijka (4).
- ▶ 5. Uklonite donji zglob (5).

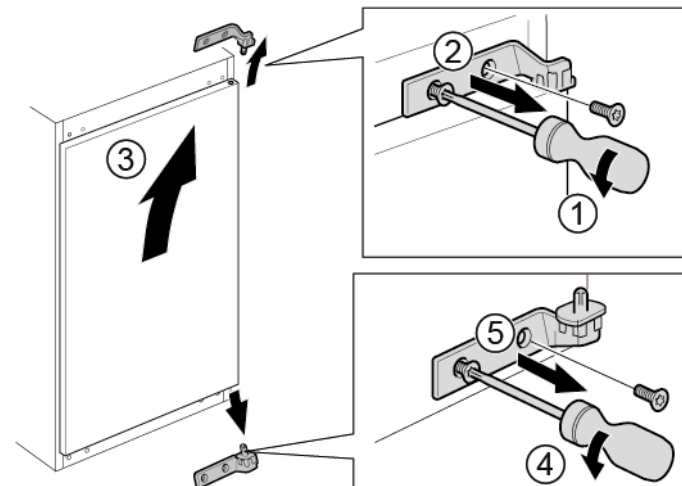

➡ Zglobovi su uklonjeni.

### 4.3.2 Postavljanje kliznog zgloba

- ▶ Postavite obratnim redoslijedom.



## 4.4 Zamjena police

### Zahtjev:

- ✔ Vrata su otvorena.

### 4.4.1 Uklanjanje police

- ▶ Izvucite policu.

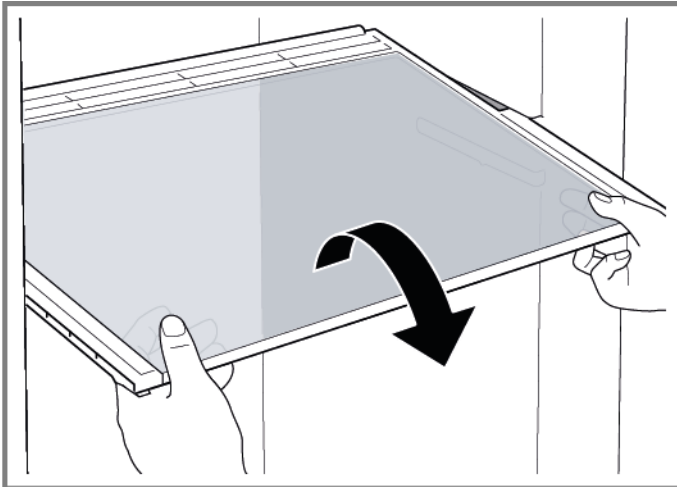

- ➡ Polica je uklonjena.

### 4.4.2 Postavljanje police

- ▶ Postavite obratnim redoslijedom.

## 4.5 Zamjena posude za vrata

### Zahtjev:

- ✔ Vrata su otvorena.

### 4.5.1 Uklanjanje posude za vrata

- ▶ Podignite posudu za vrata prema gore.

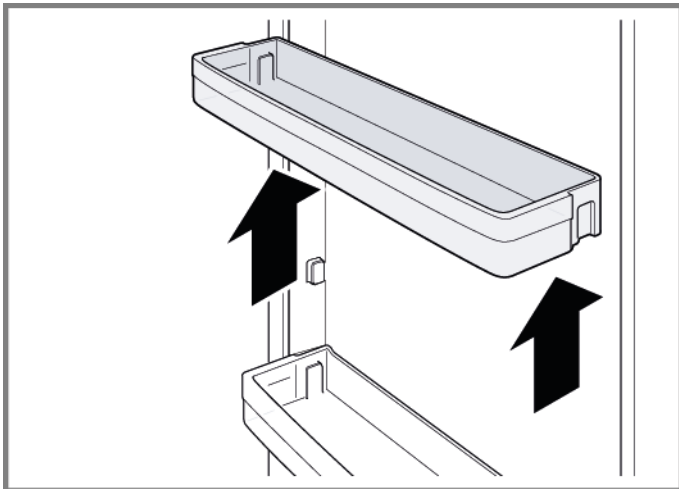

- ➡ Posuda za vrata je uklonjena.

### 4.5.2 Postavljanje posude za vrata

- ▶ Postavite obratnim redoslijedom.

## 4.6 Zamjena spremnika za voće i povrće

### Zahtjev:

- ✔ Vrata su otvorena.

### 4.6.1 Uklanjanje spremnika za voće i povrće

1. Izvucite spremnik za voće i povrće koliko je moguće.
2. 1. Podignite prednji dio spremnika za voće i povrće (1).  
2. Uklonite spremnik (2).

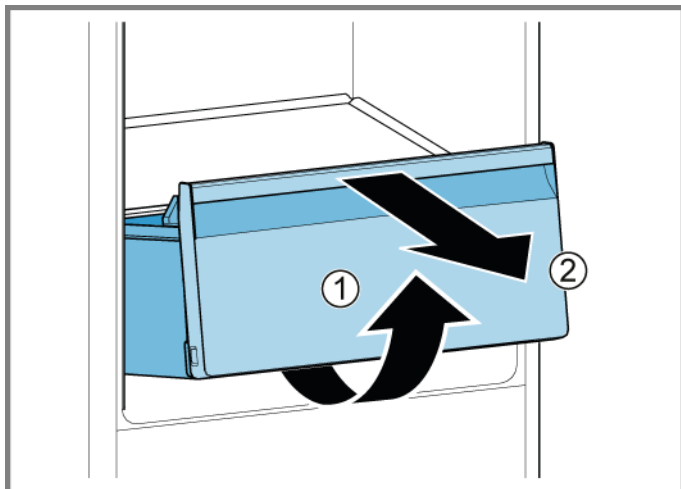

- ➡ Spremnik za voće i povrće je uklonjen.

### 4.6.2 Postavljanje spremnika za voće i povrće

- ▶ Postavite obratnim redoslijedom.

## 4.7 Zamjena bočnog LED svjetla

### Specijalni alati:

🔧 Usisna čašica Ø50 mm [00342224]

**i** Uređaj ima svjetlo LED koje ne zahtijeva održavanje.  
Ta svjetla smije popravljati samo osoblje iz službe za korisnike ili ovlašteni tehničari!

**⚠️ OPASNOST**  
**Opasnost od strujnog udara zbog dijelova koji provode struju!**  
U slučaju nepravilnog popravka može doći do opasnosti za život od strujnog udara

- ▶ Električne dijelove mora popraviti kvalificirani električar.
- ▶ Nakon popravka provedite sigurnosni test u skladu s VDE 0701 ili nacionalnim propisima.

**⚠️ OPASNOST**  
**Opasnost od strujnog udara zbog dijelova koji provode struju!**  
Smrt od strujnog udara

- ▶ Isključite uređaj iz električnog napajanja najmanje 60 sekundi prije izvođenja popravaka.

**⚠️ OPREZ**  
**Oštri rubovi!**  
Porezotine

- ▶ Nosite zaštitne rukavice.

### Zahtjev:

- ✔ Uređaj je isključen iz napajanja.
- ✔ Vrata su otvorena.
- ✔ Police su uklonjene.

### 4.7.1 Uklanjanje bočnog LED svjetla

1. Postavite dvije usisne čašice na poklopac bočnog LED svjetla.

2. Povucite usisne čašice naprijed jednim okretom.

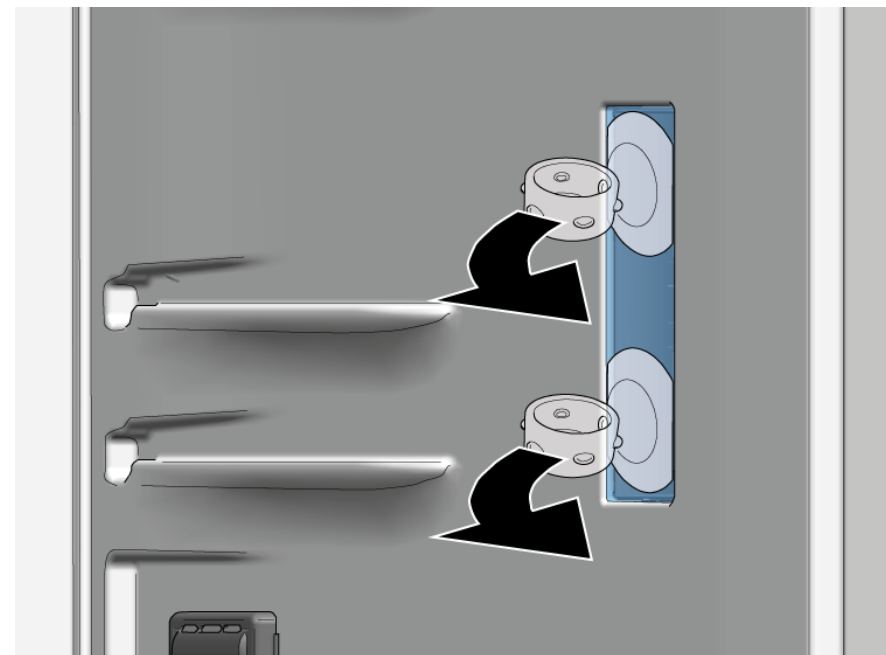

➡ Poklopac LED svjetla je uklonjen.

3. Uklonite LED modul.



 Bočno LED svjetlo je uklonjeno.



### 4.7.2 Postavljanje bočnog LED svjetla



Budući da se kuke poklopca svjetiljke lako lome pri uklanjanju, rezervni dio LED bočnog svjetla je komplet koji sadrži LED modul i poklopac svjetiljke.

- ▶ Postavite obratnim redoslijedom.

# Poznámky k opravě - Chladnička

 <b>O tomto dokumentu</b> .....	<b>35</b>
1.1 Důležité informace .....	35
1.1.1 Účel .....	35
1.2 Vysvětlení symbolů .....	35
1.2.1 Úroveň nebezpečí .....	35
1.2.2 Symboly nebezpečí .....	35
1.2.3 Struktura výstrah .....	36
1.2.4 Obecné symboly .....	36
 <b>Bezpečnost</b> .....	<b>37</b>
2.1 Všeobecné bezpečnostní pokyny .....	37
2.1.1 Všechny domácí spotřebiče .....	37
 <b>Nástroje a pomůcky</b> .....	<b>38</b>
 <b>Oprava</b> .....	<b>39</b>
4.1 Výměna těsnění dvířek .....	39
4.1.1 Vyjmutí těsnění dvířek .....	39
4.1.2 Montáž těsnění dvířek .....	39
4.2 Výměna plochých pantů .....	42
4.2.1 Odstranění plochých pantů .....	42
4.2.2 Montáž plochých pantů .....	43
4.3 Výměna posuvných závěsů .....	44
4.3.1 Odstranění posuvných závěsů .....	44
4.3.2 Montáž posuvných závěsů .....	44
4.4 Výměna odkládací plochy .....	45
4.4.1 Vyjmutí odkládací plochy .....	45
4.4.2 Montáž odkládací plochy .....	45
4.5 Výměna dveřní přihrádky .....	46
4.5.1 Vyjmutí dveřní přihrádky .....	46
4.5.2 Montáž dveřní přihrádky .....	46
4.6 Výměna zásobníku na ovoce a zeleninu .....	47
4.6.1 Vyjmutí zásobníku na ovoce a zeleninu .....	47
4.6.2 Montáž zásobníku na ovoce a zeleninu .....	47
4.7 Výměna LED bočního osvětlení .....	48
4.7.1 Vyjmutí LED bočního osvětlení .....	48
4.7.2 Montáž LED bočního osvětlení .....	49

# **i** O tomto dokumentu

## 1.1 Důležité informace

### 1.1.1 Účel

Tyto pokyny k opravě pomáhají spotřebiteli při vlastnoruční opravě spotřebičů v souladu s platnými předpisy o ekodesignu (platnými k 03/2021).



Obsahují informace o výměně některých náhradních dílů včetně příslušných výstrah a nebezpečí.

V případě dotazů se obraťte na náš zákaznický servis. Za škody ručíme pouze v případě, že budou správně dodrženy pokyny k opravě.

## 1.2 Vysvětlení symbolů

### 1.2.1 Úroveň nebezpečí

Jednotlivé úrovně výstrah se skládají ze symbolu a signálního slova. Signální slova uvádějí závažnost nebezpečí.





Úroveň výstrahy	Význam
 <b>NEBEZPEČÍ</b>	Nedodržení výstražného upozornění způsobí smrt nebo vážná zranění.
 <b>VÝSTRAHA</b>	Nedodržení výstražného upozornění může způsobit smrt nebo vážná zranění.
 <b>POZOR</b>	Nedodržení výstražného upozornění může způsobit lehká zranění.
<b>POZOR!</b>	Nedodržení výstražného upozornění může způsobit škody na majetku.

Tabulka 1: Úroveň nebezpečí



### 1.2.2 Symboly nebezpečí

Symboly nebezpečí jsou symbolická znázornění určující druh nebezpečí.

V tomto dokumentu jsou použity následující symboly nebezpečí:

Symbol nebezpečí	Význam
	Obecné výstražné upozornění
	Nebezpečí vycházející z elektrického napětí
	Nebezpečí výbuchu
	Nebezpečí pořezání
	Nebezpečí rozdrcení



## O tomto dokumentu

Symbol nebezpečí	Význam
	Nebezpečí spojené s horkými povrchy
	Nebezpečí vycházející ze silného elektromagnetického pole
	Nebezpečí z neionizujícího záření

Tabulka 2: Symboly nebezpečí

### 1.2.3 Struktura výstrah

Výstrahy použité v tomto dokumentu mají standardizovaný vzhled a strukturu.



	<div style="background-color: red; color: white; padding: 2px; text-align: center;"> <b>NEBEZPEČÍ</b></div> <p><b>Typ a zdroj nebezpečí!</b> Možné důsledky nedodržení výstražného upozornění.</p> <ul style="list-style-type: none"> <li>▶ Opatření a zákazy eliminující nebezpečí.</li> </ul>
--	--





Následující příklad ukazuje výstrahu, která varuje před zásahem elektrickým proudem při dotyku dílů pod proudem. Je uvedeno opatření pro zabránění rizika.

	<div style="background-color: red; color: white; padding: 2px; text-align: center;"> <b>NEBEZPEČÍ</b></div> <p><b>Nebezpečí úrazu elektrickým proudem při dotyku dílů pod proudem!</b> Usmrcení elektrickým proudem</p> <ul style="list-style-type: none"> <li>▶ Odpojte spotřebič od přívodu elektrického proudu alespoň 60 sekund před zahájením opravy.</li> </ul>
---	--

### 1.2.4 Obecné symboly

V tomto dokumentu jsou použity následující obecné symboly:

Obecný symbol	Význam
	Uvedení zvláštního tipu (text nebo grafické vyjádření)
	Uvedení jednoduchého tipu (pouze text)
	Uvedení odkazu k videonávodu

Obecný symbol	Význam
	Uvedení požadovaných nástrojů
	Uvedení požadovaných podmínek
	Uvedení podmínky (když, pak atd.)
	Uvedení výsledku
[Start]	Uvedení klávesy nebo tlačítka
[00123456]	Uvedení čísla materiálu
Status	Uvedení zobrazeného textu / okna (na ukazateli spotřebiče)

Tabulka 3: Obecné symboly



## **2.1 Všeobecné bezpečnostní pokyny**

### **2.1.1 Všechny domácí spotřebiče**

#### **Nebezpečí úrazu elektrickým proudem při dotyku dílů pod proudem!**

- Chyby při opravě elektrických součástí mohou vést k úrazu elektrickým proudem!
- Odpojte spotřebič ze sítě alespoň 60 sekund před zahájením prací.
- Po opravě nechte provést bezpečnostní zkoušku podle VDE 0701 nebo specifických předpisů dané země.

#### **Nebezpečí poranění o ostré hrany!**

- Používejte ochranné rukavice.

#### **Nebezpečí rozdrčení během opravy, údržby, odstranění závad a servisu těžkými a pohyblivými součástmi**

- Používejte bezpečnostní obuv.
- Zajistěte těžké součásti před pádem.
- Nesahejte na pohyblivé součásti.



#### **Nebezpečí z hlediska bezpečnosti / funkce spotřebiče!**

- Používejte pouze originální náhradní díly.

#### **Nebezpečí poškození elektrostaticky citlivých součástí (elektrostatický výboj)!**

- Nedotýkejte se modulů, včetně přípojek a vodičů.

## Nástroje a pomůcky

Označení	Detaily	Snímky
Ochranná tkanina [00342013]	60 cm x 50 cm	
Přísavka [00342224]	Ø50 mm	
Torx Bit TX20 [00340865]	6,3 mm (1/4")	

## 4.1 Výměna těsnění dvířek

### Požadavek:

- ✔ Dvířka jsou otevřená.

### 4.1.1 Vyjmutí těsnění dvířek

1. Uvolněte těsnění dvířek z drážky v pravém a levém rohu.



2. Vytáhněte těsnění z drážky.



- ➡ Těsnění dvířek je vyjmuté.

### 4.1.2 Montáž těsnění dvířek





Nové těsnění dvířek může mít trochu jinou šířku než původní těsnění. Dovření dvířek ani dlouhodobá funkce tím nebudou ovlivněny. Pokud má spotřebič nastavitelné závěsy nebo nástavce závěsů, můžete dovření dvířek následně upravit. Malé boční otvory v těsnění dvířek jsou funkční (slouží pro přívod vzduchu). Nejsou vadou výrobku.

1. Zkontrolujte, zda není poškozena drážka těsnění.

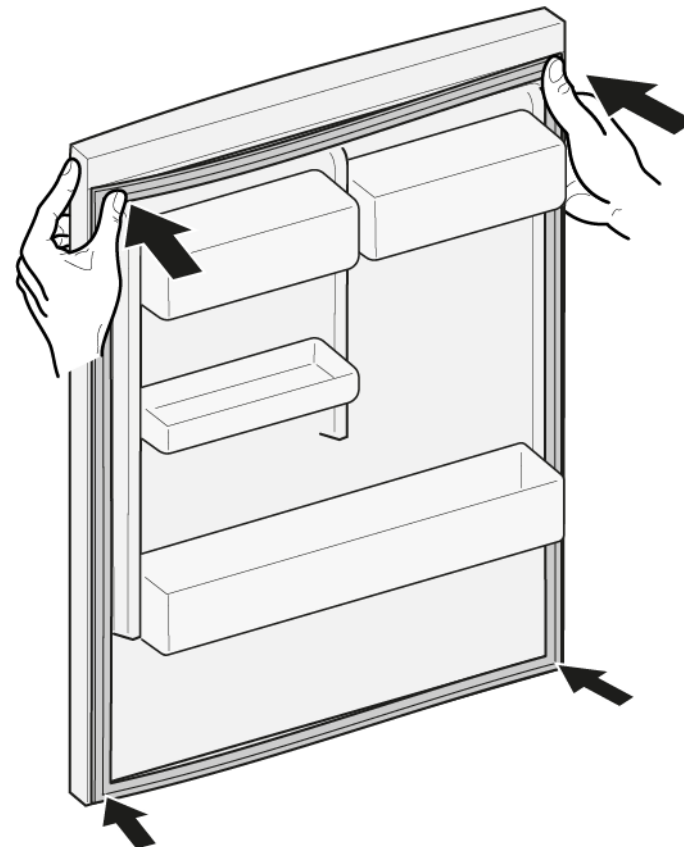

4. Zatlačte horní a dolní rohy těsnění do drážky.



2.  Pokud je drážka těsnění poškozená,  
- kontaktujte zákaznický servis.

3.  Lehká deformace těsnění dvířek je normální a nemá vliv na jeho funkci. Před vložením do spotřebiče doporučujeme těsnění narovnat.

Těsnění zahřejte fénem nebo horkou vodou a manuálně upravte jeho tvar.

5. Postupně zatlačte do drážky celé těsnění.



 Těsnění dvířek je namontované.

## 4.2 Výměna plochých pantů

### Speciální nástroje:

 Torx Bit TX20

6,3 mm (1/4")

[00340865]

	<b>⚠ VÝSTRAHA</b>
	<p><b>Těžké, objemné spotřebiče!</b> Poranění zad a svalů</p> <ul style="list-style-type: none"> <li>▶ Odstranění dvířek spotřebiče by měl provádět výhradně školený odborník.</li> <li>▶ Pro manipulaci se spotřebičem jsou nutní dva lidé.</li> <li>▶ Použijte pouze vhodné nástroje a zařízení.</li> </ul>



	<b>⚠ POZOR</b>
	<p><b>Ostré hrany!</b> Nebezpečí řezných poranění</p> <ul style="list-style-type: none"> <li>▶ Používejte ochranné rukavice.</li> </ul>

	<b>⚠ POZOR</b>
	<p><b>Otevřete prostor se závěsy!</b> Rozdrcení prstů / zachycení</p> <ul style="list-style-type: none"> <li>▶ Nesahejte do prostoru se závěsy.</li> <li>▶ Používejte ochranné rukavice.</li> </ul>

	<b>⚠ POZOR</b>
	<p><b>Nebezpečí padajících dílů kvůli uvolněným šroubům!</b> Poranění padajícími díly.</p> <ul style="list-style-type: none"> <li>▶ Zajistěte jednotlivé součásti před pádem.</li> </ul>

	<b>POZOR!</b>
	<p><b>Nebezpečí padajících dílů kvůli uvolněným šroubům!</b> Poškození jiných částí spotřebiče nebo prvků domácnosti zákazníka, např. podlahy.</p> <ul style="list-style-type: none"> <li>▶ Zajistěte jednotlivé součásti před pádem.</li> </ul>

### Požadavek:

-  Spotřebič je odpojený od přívodu elektrické energie.
-  Čelní dvířka nábytku jsou vyjmutá. Viz návod k montáži.
-  Dvířka jsou otevřená.

### 4.2.1 Odstranění plochých pantů

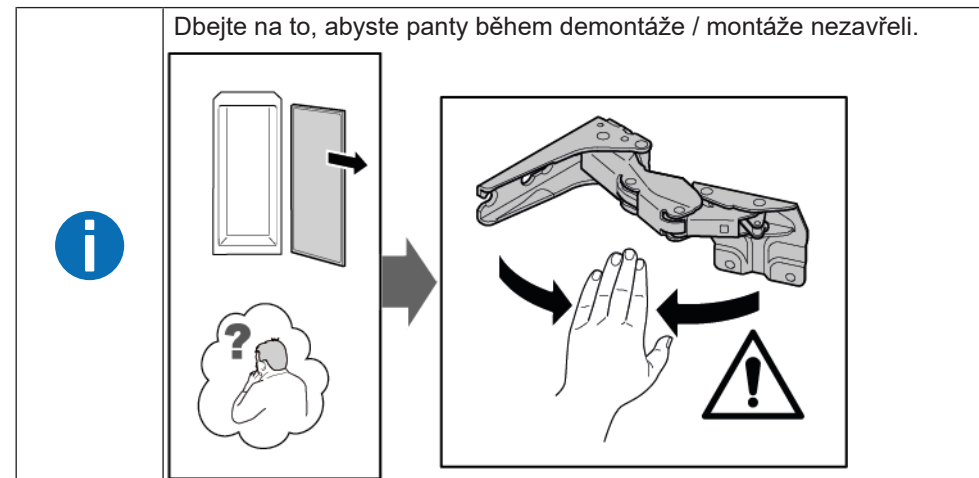

1. Sejměte dva kryty pantů.

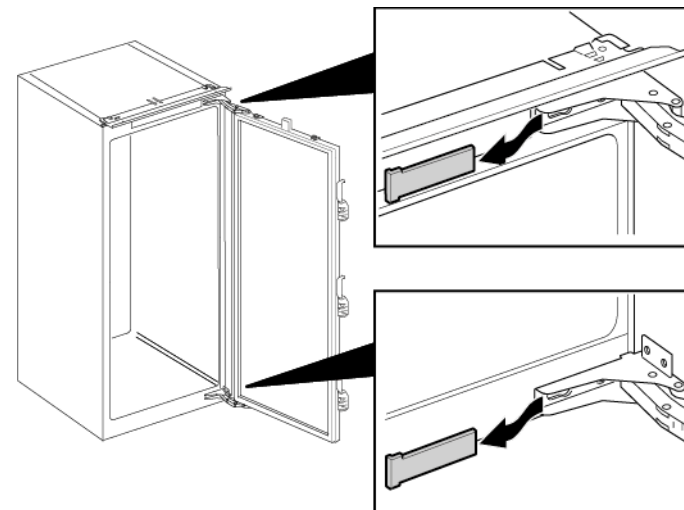

## Oprava

2. 1. Uvolněte čtyři šrouby (1).
2. Vysuňte a vyjměte dvířka (2).

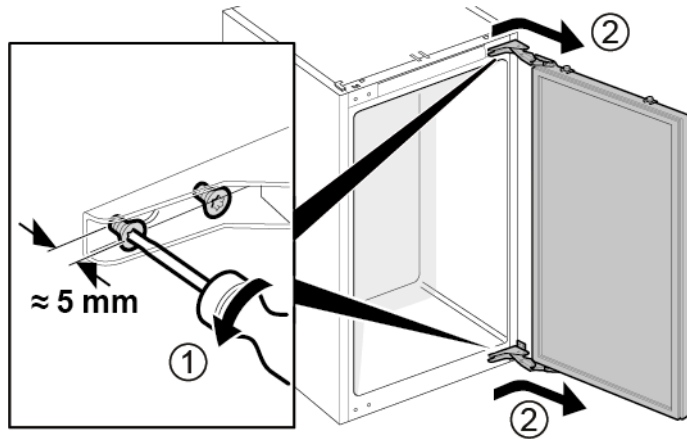

3. 1. Odstraňte čtyři šrouby (1).
2. Vyměňte panty (2).

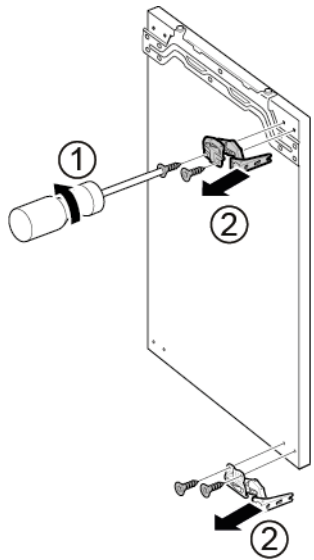

 Závěsy jsou vyjmuté.

### 4.2.2 Montáž plochých pantů

- ▶ Montáž provedte v opačném sledu.

## 4.3 Výměna posuvných závěsů

### Speciální nástroje:

Torx Bit TX20 6,3 mm (1/4") [00340865]

	<b>⚠ VÝSTRAHA</b>
	<p><b>Těžké, objemné spotřebiče!</b> Poranění zad a svalů</p> <ul style="list-style-type: none"> <li>▶ Odstranění dvířek spotřebiče by měl provádět výhradně školený odborník.</li> <li>▶ Pro manipulaci se spotřebičem jsou nutní dva lidé.</li> <li>▶ Použijte pouze vhodné nástroje a zařízení.</li> </ul>

	<b>⚠ POZOR</b>
	<p><b>Ostré hrany!</b> Nebezpečí řezných poranění</p> <ul style="list-style-type: none"> <li>▶ Používejte ochranné rukavice.</li> </ul>

	<b>⚠ POZOR</b>
	<p><b>Nebezpečí padajících dílů kvůli uvolněným šroubům!</b> Poranění padajícími díly.</p> <ul style="list-style-type: none"> <li>▶ Zajistěte jednotlivé součásti před pádem.</li> </ul>

	<b>POZOR!</b>
	<p><b>Nebezpečí padajících dílů kvůli uvolněným šroubům!</b> Poškození jiných částí spotřebiče nebo prvků domácnosti zákazníka, např. podlahy.</p> <ul style="list-style-type: none"> <li>▶ Zajistěte jednotlivé součásti před pádem.</li> </ul>

### Požadavek:

- ✔ Spotřebič je odpojený od přívodu elektrické energie.
- ✔ Čelní dvířka nábytku a dvířka spotřebiče jsou oddělené. Viz návod k montáži.

### 4.3.1 Odstranění posuvných závěsů

- ▶ 1. Vyšroubujte dva šrouby (1).
- ▶ 2. Vyjměte horní závěs (2).
- ▶ 3. Vyjměte dvířka (3).
- ▶ 4. Vyšroubujte dva šrouby (4).
- ▶ 5. Vyjměte spodní závěs (5).

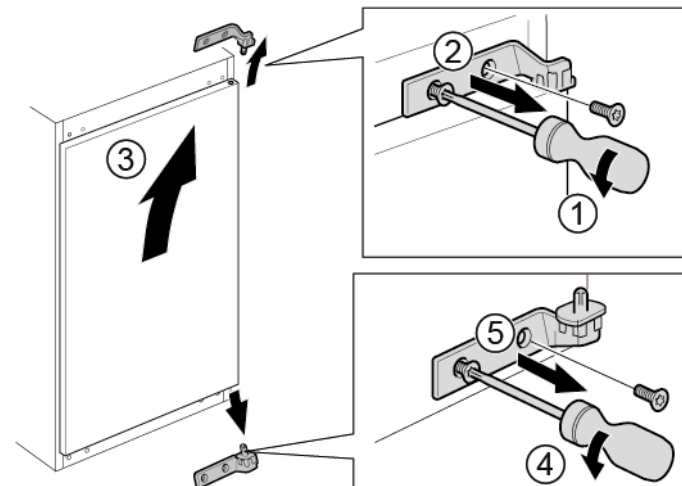

➡ Závěsy jsou vyjmuté.

### 4.3.2 Montáž posuvných závěsů

- ▶ Montáž proveďte v opačném sledu.



## 4.4 Výměna odkládací plochy

### Požadavek:

- ✔ Dvířka jsou otevřená.

### 4.4.1 Vyjmutí odkládací plochy

- ▶ Vytáhněte odkládací plochu.

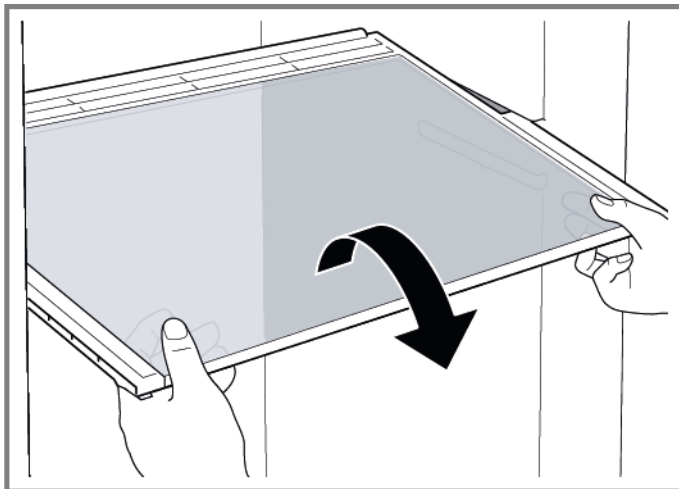

- ➡ Odkládací plocha je vyjmutá.

### 4.4.2 Montáž odkládací plochy

- ▶ Montáž proveďte v opačném sledu.

## 4.5 Výměna dveřní přihrádky

### Požadavek:

- ✔ Dvířka jsou otevřená.

### 4.5.1 Vyjmutí dveřní přihrádky

- ▶ Zvedněte dveřní přihrádku nahoru.

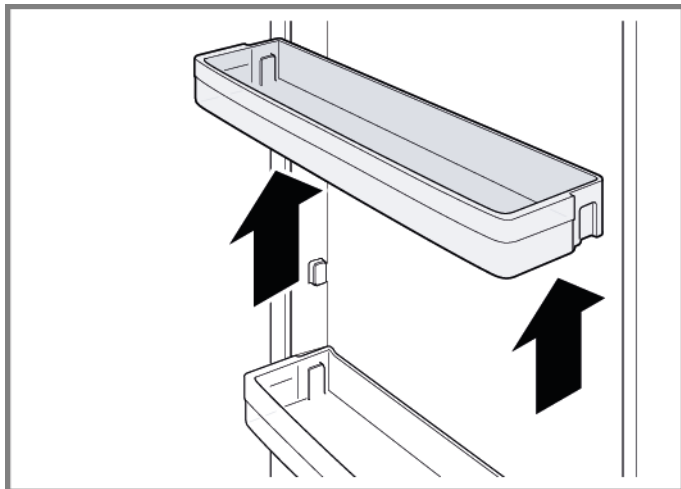

- ➡ Dveřní přihrádka je vyjmutá.

### 4.5.2 Montáž dveřní přihrádky

- ▶ Montáž proveďte v opačném sledu.

## 4.6 Výměna zásobníku na ovoce a zeleninu

### Požadavek:

- ✔ Dvířka jsou otevřená.

### 4.6.1 Vyjmutí zásobníku na ovoce a zeleninu

1. Co nejvíce vytáhněte zásobník na ovoce a zeleninu.
2. 1. Zvedněte vpředu (1) zásobník na ovoce a zeleninu.  
2. Vyjměte zásobník (2).

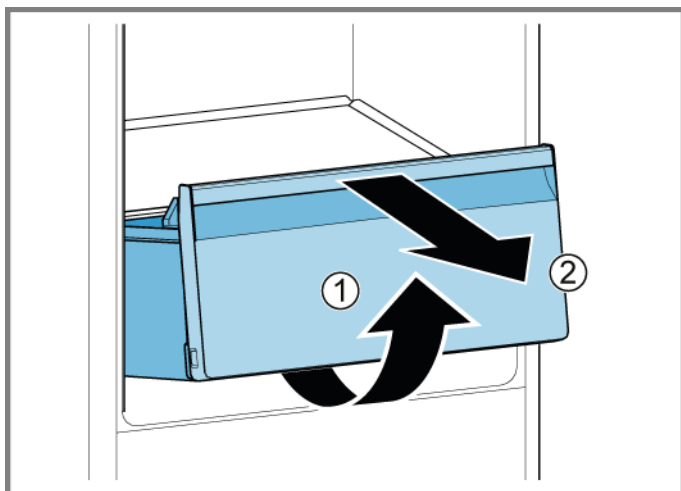

- ➡ Zásobník na ovoce a zeleninu je vyjmutý.

### 4.6.2 Montáž zásobníku na ovoce a zeleninu

- ▶ Montáž proveďte v opačném sledu.

## 4.7 Výměna LED bočního osvětlení

### Speciální nástroje:

➤ Přísavka Ø50 mm [00342224]

**i** Váš spotřebič je vybaven bezúdržbovým LED osvětlením. Tato osvětlení smí být opravena pouze zákaznickým servisem nebo oprávněným technikem!

**⚠ NEBEZPEČÍ**  
**Nebezpečí úrazu elektrickým proudem při dotyku dílů pod proudem!**  
V případě neodborné opravy hrozí nebezpečí smrtelného úrazu elektrickým proudem

- ▶ Opravu elektrického zařízení smí provádět jen kvalifikovaný elektrikář.
- ▶ Po opravě nechte provést bezpečnostní zkoušku podle VDE 0701 nebo specifických předpisů dané země.

**⚠ NEBEZPEČÍ**  
**Nebezpečí úrazu elektrickým proudem při dotyku dílů pod proudem!**  
Usmrcení elektrickým proudem

- ▶ Odpojte spotřebič od přívodu elektrického proudu alespoň 60 sekund před zahájením opravy.

**⚠ POZOR**  
**Ostré hrany!**  
Nebezpečí řezných poranění

- ▶ Používejte ochranné rukavice.

### Požadavek:

- ✔ Spotřebič je odpojený od přívodu elektrické energie.
- ✔ Dvířka jsou otevřená.
- ✔ Police jsou vyjmuté.

### 4.7.1 Vyjmutí LED bočního osvětlení

1. Přilepte dvě přísavky na kryt LED bočního osvětlení.

2. Otočením vytáhněte přísavky dopředu.

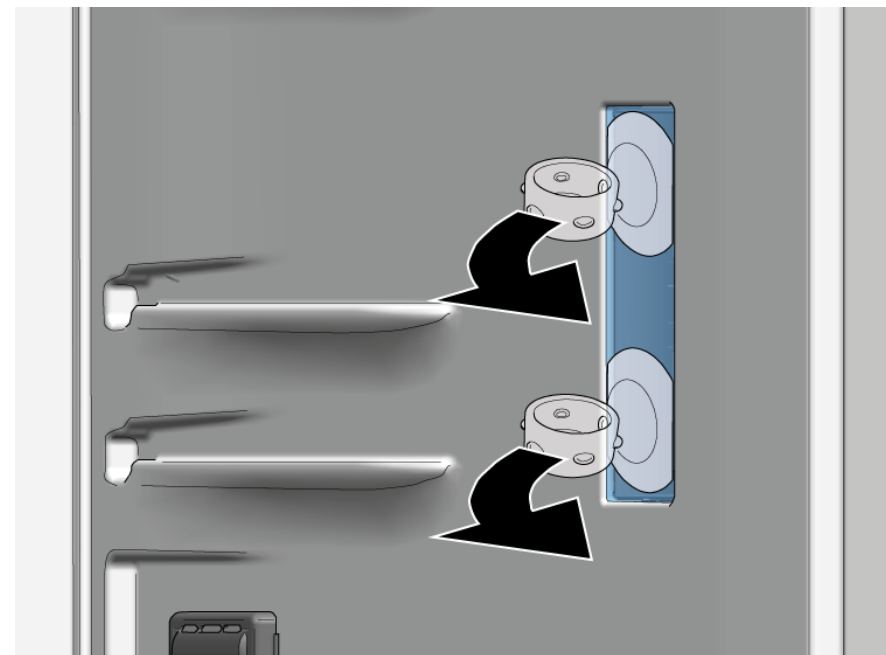

➡ Kryt LED osvětlení je vyjmutý.

3. Vyměňte LED modul.

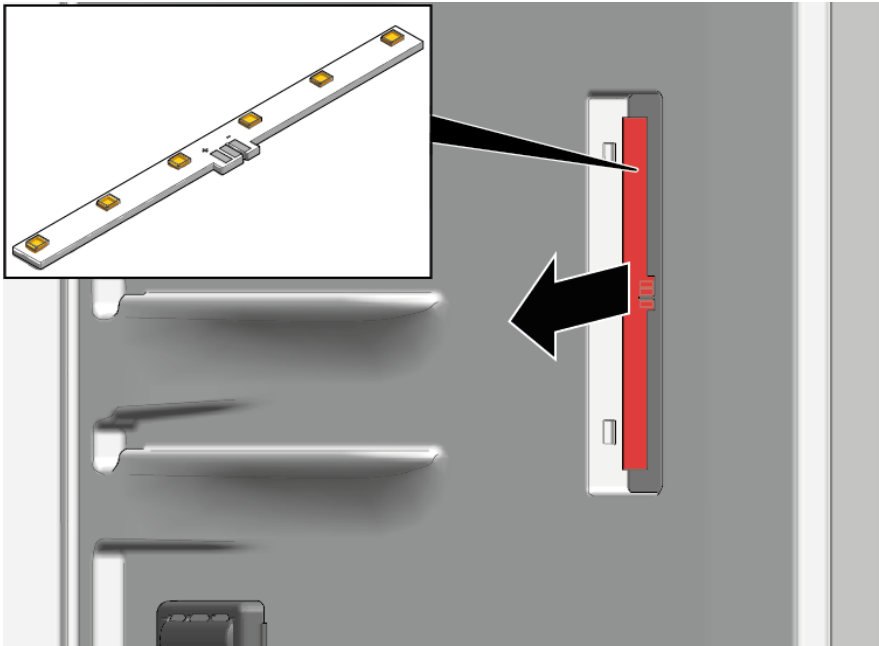

 LED boční osvětlení je vyjmuté.

### 4.7.2 Montáž LED bočního osvětlení



Protože se háky krytu žárovky během demontáže snadno zlomí, obsahuje sada náhradních dílů LED bočního světla LED modul a kryt osvětlení.

► Montáž proveďte v opačném sledu.

# Tip til reparation - Køleskab

 <b>Om dette dokument</b> .....	<b>51</b>
1.1 Vigtig information.....	51
1.1.1 Formål.....	51
1.2 Forklaring af symboler .....	51
1.2.1 Fareniveauer .....	51
1.2.2 Faresymboler.....	51
1.2.3 Advarslernes opbygning .....	52
1.2.4 Generelle symboler .....	52
 <b>Sikkerhed</b> .....	<b>53</b>
2.1 Generelle sikkerhedsanvisninger .....	53
2.1.1 Alle husholdningsapparater .....	53
 <b>Værktøjer og hjælpemidler</b> .....	<b>54</b>
 <b>Reparation</b> .....	<b>55</b>
4.1 Udskiftning af dørpakning.....	55
4.1.1 Fjernelse af dørpakning.....	55
4.1.2 Montering af dørpakning.....	55
4.2 Udskiftning af fladhængsel .....	58
4.2.1 Fjernelse af fladhængsel .....	58
4.2.2 Montering af fladhængsel .....	59
4.3 Udskiftning af glidehængsel .....	60
4.3.1 Fjernelse af glidehængsel.....	60
4.3.2 Montering af glidehængsel.....	60
4.4 Udskiftning af hylde .....	61
4.4.1 Fjernelse af hylde.....	61
4.4.2 Montering af hylde .....	61
4.5 Udskiftning af dørhylde .....	62
4.5.1 Fjernelse af dørhylde.....	62
4.5.2 Montering af dørhylde .....	62
4.6 Udskiftning af frugt- og grøntsagsbeholder .....	63
4.6.1 Fjernelse af frugt- og grøntsagsbeholder .....	63
4.6.2 Montering af frugt- og grøntsagsbeholder .....	63
4.7 Udskiftning af LED-sidelampe .....	64
4.7.1 Fjernelse af LED-sidelampe.....	64
4.7.2 Montering af LED-sidelampe.....	65

# **i** Om dette dokument

## 1.1 Vigtig information

### 1.1.1 Formål

Disse reparationsanvisninger hjælper kunden til selv at kunne reparere apparater i henhold til den gældende lovgivning om miljøvenligt design (fra 03/2021).





De indeholder information om, hvordan der udskiftes bestemte reservedele, herunder advarsler og risici.

Kontakt kundeservice i tilfælde af spørgsmål. Vi påtager os kun ansvar for skader, hvis reparationsanvisningerne er fuldt korrekt.

## 1.2 Forklaring af symboler

### 1.2.1 Fareniveauer

Advarselsniveauerne består af et symbol og et signalford. Signalfordene indikerer farens alvor.





Advarselsniveau	Betydning
	Manglende overholdelse af advarselsmeddelelsen vil medføre død eller alvorlige kvæstelser.
	Manglende overholdelse af advarselsmeddelelsen kan medføre død eller alvorlige kvæstelser.
	Manglende overholdelse af advarselsmeddelelsen kan medføre mindre kvæstelser.
	Manglende overholdelse af advarselsmeddelelsen kan medføre materiel beskadigelse.

Tabel 1: Fareniveauer





### 1.2.2 Faresymboler

Faresymboler er symbolske visninger, der giver en indikation af faretypen.

Der anvendes følgende faresymboler i dette dokument:

Faresymbol	Betydning
	Generel advarselsmeddelelse
	Fare for elektrisk spænding
	Eksplussionsfare
	Fare for at skære sig

## i Om dette dokument

Faresymbol	Betydning
	Fare for klemning
	Fare pga. varme overflader
	Fare pga. kraftigt magnetfelt
	Fare pga. ikke-ioniserende stråling

Tabel 2: Faresymboler

### 1.2.3 Advarslernes opbygning

Advarsler i dette dokument har et standardiseret udseende og en standardiseret opbygning.

	<p><b>FARE</b></p> <p><b>Farens type og kilde!</b>            Mulige følger, hvis faren/advarslen ignoreres.</p> <ul style="list-style-type: none"> <li>▶ Foranstaltninger og forbud for at forhindre faren.</li> </ul>
--	---

De følgende eksempler viser en advarsel, der advarer mod elektrisk stød pga. spændingsførende dele. Foranstaltningen til at undgå faren er nævnt.

	<p><b>FARE</b></p> <p><b>Fare for elektrisk stød pga. spændingsførende dele!</b>            Død ved elektrisk stød</p> <ul style="list-style-type: none"> <li>▶ Afbryd apparater fra strømforsyningen i mindst 60 sekunder, før reparationer påbegyndes.</li> </ul>
--	---

### 1.2.4 Generelle symboler

Der anvendes følgende generelle symboler i dette dokument:

Generelt symbol	Betydning
	Angivelse af et særligt tip (tekst og/eller grafik)
	Angivelse af et simpelt tip (kun tekst)
	Angivelse af et link til en videotutorial
	Angivelse af nødvendige værktøjer
	Angivelse af krævede forudsætninger
	Angivelse af en betingelse (hvis..., så...)
	Angivelse af et resultat
	Angivelse af en tast eller knap
	Angivelse af et materialenummer
	Angivelse af en vist tekst/et vist vindue (i apparatets display)

Tabel 3: Generelle symboler



## 2.1 Generelle sikkerhedsanvisninger

### 2.1.1 Alle husholdningsapparater

#### **Fare for elektrisk stød pga. spændingsførende dele!**

- Fejl i forbindelse med reparationer, der involverer elektriske komponenter, kan medføre elektrisk stød!
- Afbryd apparatet fra strømnettet i mindst 60 sekunder, før arbejdet påbegyndes.
- Få efter reparationen udført en sikkerhedstest i henhold til VDE 0701 eller landespecifikke forskrifter.

#### **Fare for tilskadekomst pga. skarpe kanter!**

- Brug beskyttelseshandsker.

#### **Fare for klemning i forbindelse med reparation, vedligeholdelse, fejlafhjælpning og service på grund af tunge og bevægelige komponenter**

- Brug sikkerhedssko.
- Sørg for at sikre tunge komponenter mod at falde ned.
- Stik kropsdele ind i bevægelige komponenter.



#### **Fare for apparatets sikkerhed/funktion!**

- Brug kun originale reservedele.

#### **Fare for beskadigelse af elektrostatisk følsomme komponenter (elektrostatiske afladninger)!**

- Berør ikke modulerne, herunder forbindelser og ledningsbaner.

## Værktøjer og hjælpemidler

Betegnelse	Detaljer	Billeder
Beskyttelsesklud [00342013]	60 cm x 50 cm	
Sugekop [00342224]	Ø50 mm	
Torx-bit TX20 [00340865]	6,3 mm (1/4")	

## 4.1 Udskiftning af dørpakning

### Preindstilling:

- ✔ Døren er åben.

### 4.1.1 Fjernelse af dørpakning

1. Frigør dørpakningen fra rillen i højre og venstre hjørne.

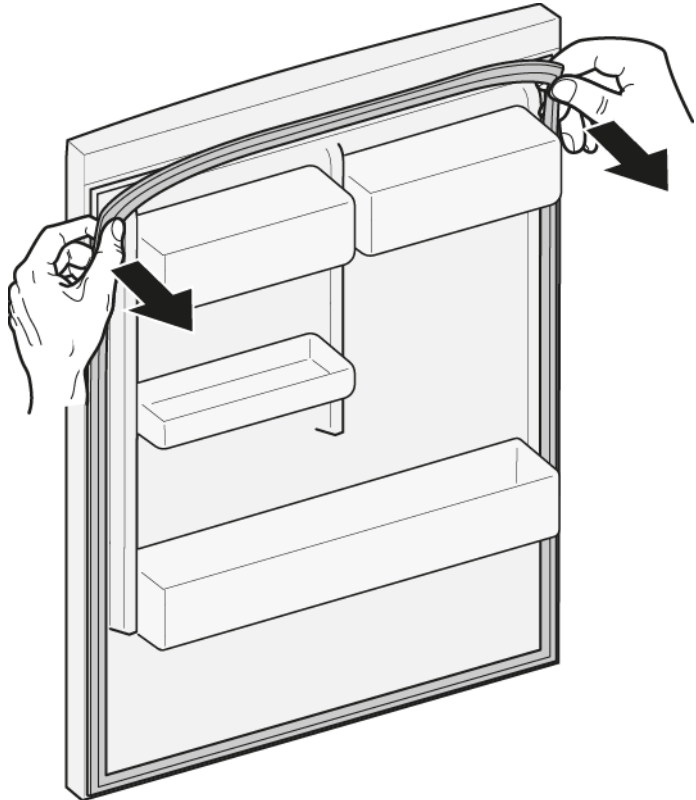

2. Træk dørpakningen ud af rillen.

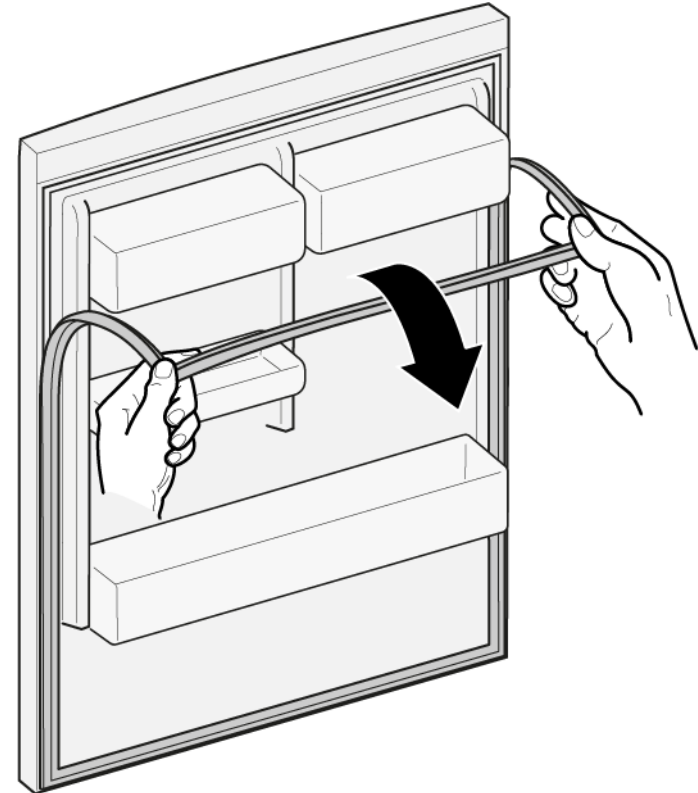

- ➡ Dørpakningen er fjernet.

### 4.1.2 Montering af dørpakning



Tykkelsen af den nye dørpakning kan afvige en smule fra tykkelsen af den gamle dørpakning. Dette vil ikke påvirke lukkemåden og den langsigtede funktion.

Hvis apparatet har justerbare hængsler eller hængselbeslag, kan lukkemåden efterfølgende optimeres.

Små sidehuller i dørpakningen er funktionelle (nødvendige til lufttilførelse). De er ikke produktionsfejl.

## Reparation

1. Kontrollér rillen til pakningen med hensyn til beskadigelse.

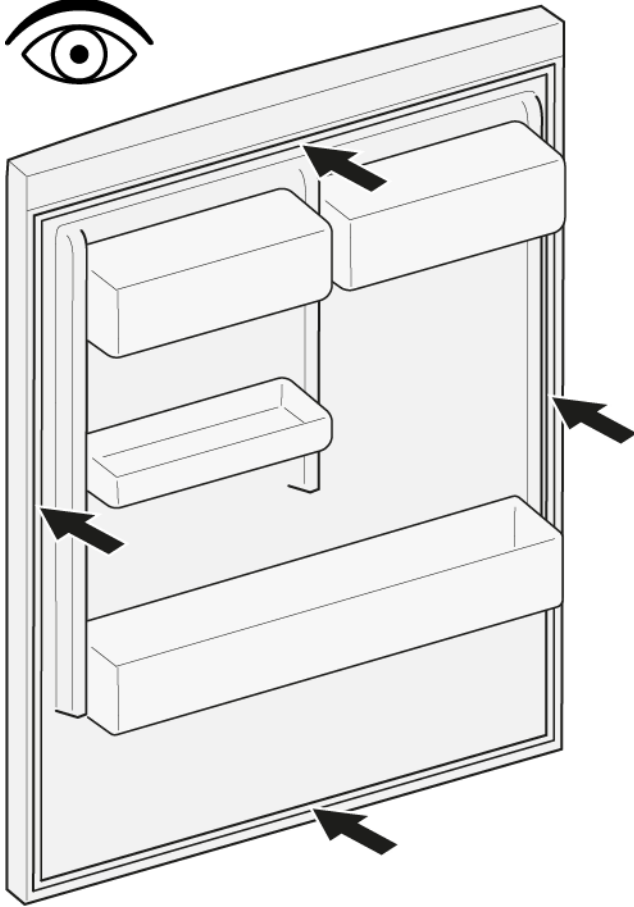

4. Tryk pakningens hjørner i rillen foroven og forneden.

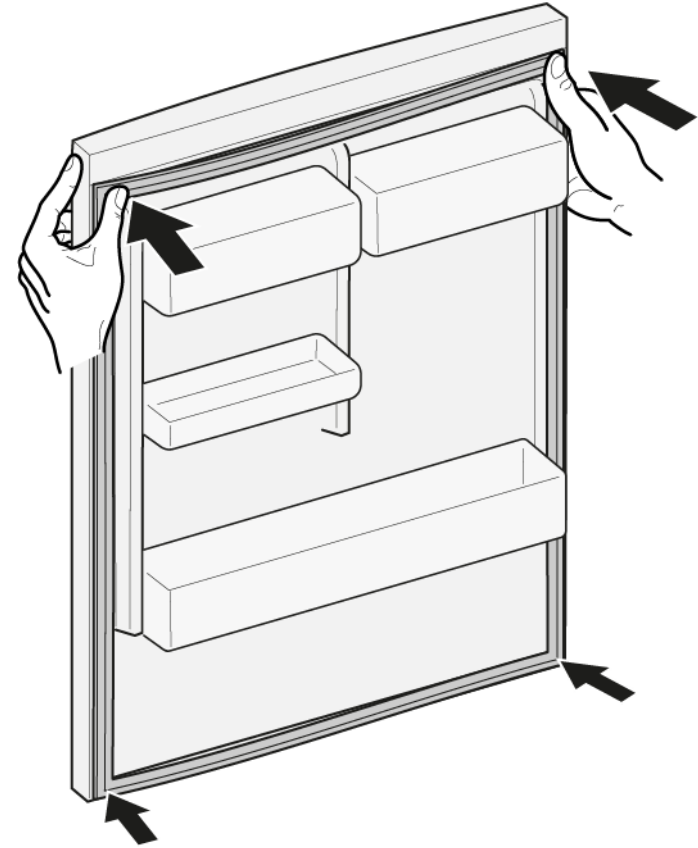

2.  Hvis rillen til pakningen er beskadiget:
  - Kontakt kundeservice.

3.  En smule deformation på dørpakningen er normalt og påvirker ikke dens funktion. Det anbefales til at glatte dørpakningen, før den sættes i apparatet.

Opvarm dørpakningen med en hårtørrer eller varmt vand, og genform den manuelt.

## Reparation

5. Tryk hele pakningen trinvist i rillen.



 Dørpakningen er monteret.

## 4.2 Udskiftning af fladhængsel

### Nødvendig værktøj:

🌀 Torx-bit TX20

6,3 mm (1/4")

[00340865]

	<b>⚠ ADVARSEL</b>
	<p><b>Tunge, store apparater!</b> Ryg- og muskelskader</p> <ul style="list-style-type: none"> <li>▶ Arbejde til fjernelse af apparatets dør bør kun udføres af uddannede specialister.</li> <li>▶ Der skal være to personer om at flytte apparatet.</li> <li>▶ Brug kun egnet værktøj og udstyr.</li> </ul>

	<b>⚠ PAS PÅ!</b>
	<p><b>Skarpe kanter!</b> Snitlæsioner</p> <ul style="list-style-type: none"> <li>▶ Brug beskyttelseshandsker.</li> </ul>

	<b>⚠ PAS PÅ!</b>
	<p><b>Åbent hængselområde!</b> Fingre kan blive klemt/sætte sig fast</p> <ul style="list-style-type: none"> <li>▶ Grib ikke ind i hængselområdet.</li> <li>▶ Brug beskyttelseshandsker.</li> </ul>

	<b>⚠ PAS PÅ!</b>
	<p><b>Fare for nedfaldende dele pga. løsnede skruer!</b> Personskade pga. nedfaldende dele.</p> <ul style="list-style-type: none"> <li>▶ Sørg for at sikre komponenten mod at falde ned.</li> </ul>

	<b>BEMÆRK!</b>
	<p><b>Fare for nedfaldende dele pga. løsnede skruer!</b> Beskadigelse af andre apparatdele eller kundens hjem, f.eks. gulvet.</p> <ul style="list-style-type: none"> <li>▶ Sørg for at sikre komponenten mod at falde ned.</li> </ul>

### Preindstilling:

- ✅ Apparaten er afbrudt fra strømforsyningen.
- ✅ Møbeldøren er fjernet. Se monteringsanvisningen.
- ✅ Døren er åben.

## 4.2.1 Fjernelse af fladhængsel

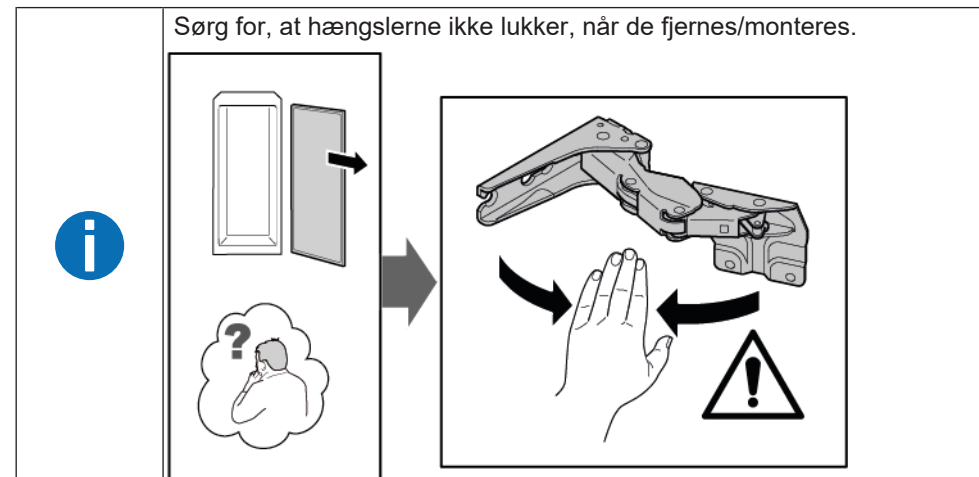

1. Fjern de to hængsels afdækninger.

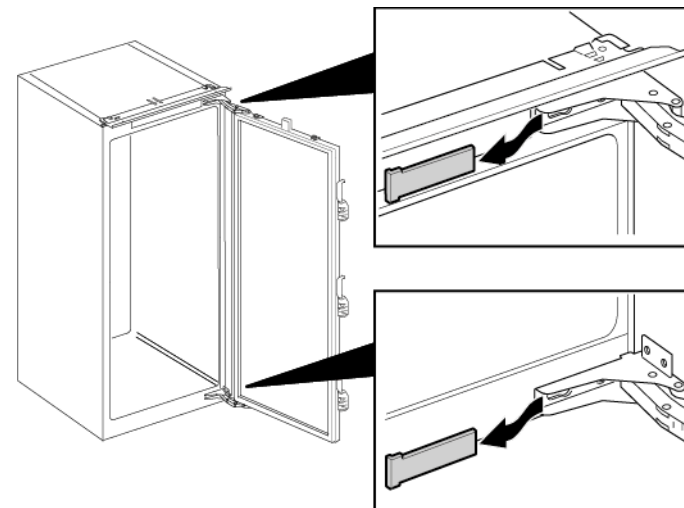

## Reparation

2. 1. Løsn de fire skruer (1).
2. Glid døren ud, og fjern den (2).

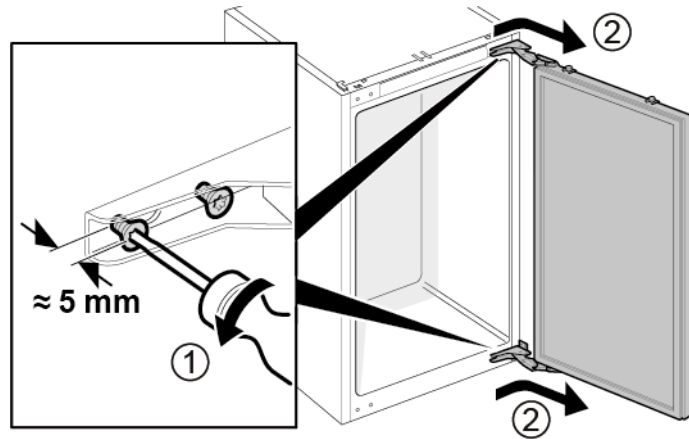

3. 1. Fjern de fire skruer (1).
2. Fjern hængslerne (2).

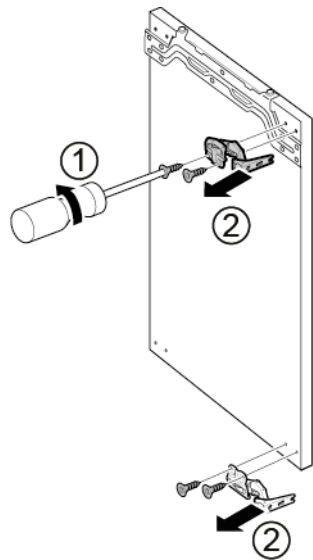

 Hængslerne er fjernet.

### 4.2.2 Montering af fladhængsel

- ▶ Monter i omvendt rækkefølge.

## 4.3 Udskiftning af glidehængsel

### Nødvendig værktøj:

🌀 Torx-bit TX20

6,3 mm (1/4")

[00340865]



### ⚠️ ADVARSEL

#### Tunge, store apparater!

Ryg- og muskelskader

- ▶ Arbejde til fjernelse af apparatets dør bør kun udføres af uddannede specialister.
- ▶ Der skal være to personer om at flytte apparatet.
- ▶ Brug kun egnet værktøj og udstyr.



### ⚠️ PAS PÅ!

#### Skarpe kanter!

Snitlæsioner

- ▶ Brug beskyttelseshandsker.



### ⚠️ PAS PÅ!

#### Fare for nedfaldende dele pga. løsnede skruer!

Personskade pga. nedfaldende dele.

- ▶ Sørg for at sikre komponenten mod at falde ned.



### BEMÆRK!

#### Fare for nedfaldende dele pga. løsnede skruer!

Beskadigelse af andre apparatdele eller kundens hjem, f.eks. gulvet.

- ▶ Sørg for at sikre komponenten mod at falde ned.

### Preindstilling:

- ✔️ Apparatet er afbrudt fra strømforsyningen.
- ✔️ Møbeldøren og apparatets dør er adskilt. Se monteringsanvisningen.

## 4.3.1 Fjernelse af glidehængsel

- ▶ 1. Skru de to skruer ud (1).
- ▶ 2. Fjern det øverste hængsel (2).
- ▶ 3. Fjern døren (3).
- ▶ 4. Skru de to skruer ud (4).
- ▶ 5. Fjern det nederste hængsel (5).

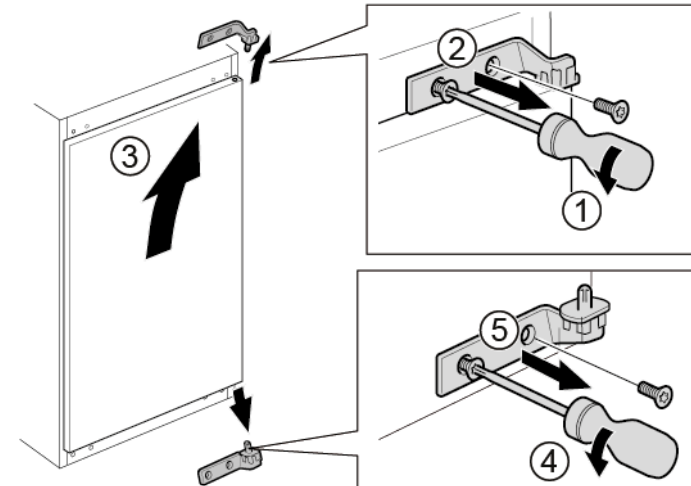

➡ Hængslerne er fjernet.

## 4.3.2 Montering af glidehængsel

- ▶ Monter i omvendt rækkefølge.



## 4.4 Udskiftning af hylde

### Preindstilling:

- ✔ Døren er åben.

### 4.4.1 Fjernelse af hylde

- ▶ Træk hylde ud.



- ➡ Hylde er fjernet.

### 4.4.2 Montering af hylde

- ▶ Montér i omvendt rækkefølge.

## 4.5 Udskiftning af dørhylde

Preindstilling:

- ✔ Døren er åben.

### 4.5.1 Fjernelse af dørhylde

- ▶ Løft dørhylden opad.

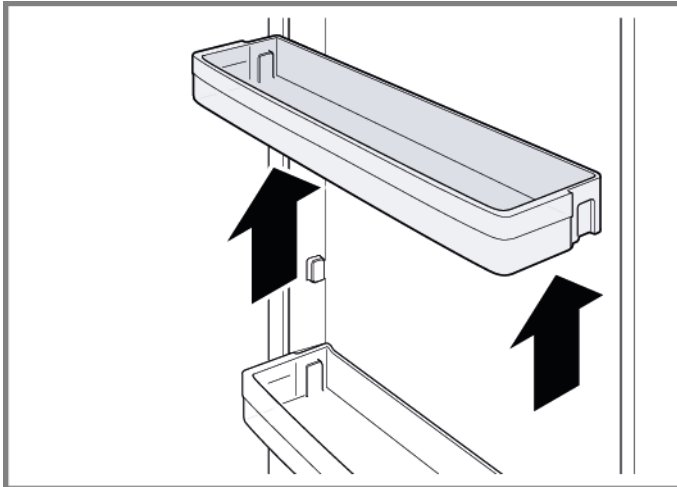

➡ Dørhylden er fjernet.

### 4.5.2 Montering af dørhylde

- ▶ Montér i omvendt rækkefølge.

## 4.6 Udskiftning af frugt- og grøntsagsbeholder

### Preindstilling:

- ✔ Døren er åben.

### 4.6.1 Fjernelse af frugt- og grøntsagsbeholder

1. Træk frugt- og grøntsagsbeholderen så langt ud, som den kan komme.
2. 1. Løft frugt- og grøntsagsbeholderen op foran (1).  
2. Fjern beholderen (2).



- ➡ Beholderen med frugt og grøntsager er fjernet.

### 4.6.2 Montering af frugt- og grøntsagsbeholder

- ▶ Montér i omvendt rækkefølge.

## 4.7 Udskiftning af LED-sidelampe

### Nødvendig værktøj:

🌀 Sugkop Ø50 mm [00342224]

**i** Dit apparat er udstyret med en vedligeholdelsesfri LED-lampe. Denne lampe må kun repareres af kundeservice eller autoriserede teknikere!

**⚠️ FARE**  
**Fare for elektrisk stød pga. spændingsførende dele!**  
Livsfare pga. elektrisk stød i tilfælde af ukorrekt reparation

- ▶ Elektriske dele skal repareres af kvalificerede elektrikere.
- ▶ Få efter reparationen udført en sikkerhedstest i henhold til VDE 0701 eller landespecifikke forskrifter.

**⚠️ FARE**  
**Fare for elektrisk stød pga. spændingsførende dele!**  
Død ved elektrisk stød

- ▶ Afbryd apparater fra strømforsyningen i mindst 60 sekunder, før reparationer påbegyndes.

**⚠️ PAS PÅ!**  
**Skarpe kanter!**  
Snitlæsioner

- ▶ Brug beskyttelseshandsker.

### Preindstilling:

- ✔️ Apparatet er afbrudt fra strømforsyningen.
- ✔️ Døren er åben.
- ✔️ Hyldeerne er fjernet.

### 4.7.1 Fjernelse af LED-sidelampe

1. Sæt to sugekopper på LED-sidelampens afdækning.

2. Træk sugekopperne fremad i en drejende bevægelse.

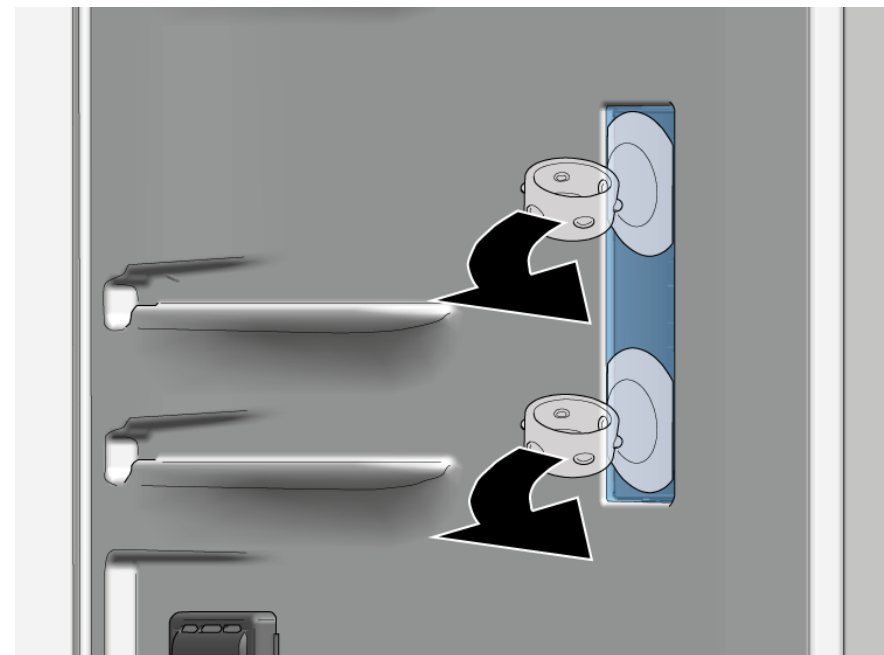

- ➡️ LED-lampens afdækning er fjernet.

## Reparation

3. Fjern LED-modulet.



 LED-sidelampen er fjernet.

### 4.7.2 Montering af LED-sidelampe



Eftersom krogene på lampens afdækning knækker nemt under fjernelsesproceduren består LED-sidelampen som reservedel af et sæt, der inkluderer LED-modulet og lampens afdækning.

- ▶ Montér i omvendt rækkefølge.

# Reparatie informatie - Koelkast

 <b>Over dit document</b> .....	<b>67</b>
1.1 Belangrijke informatie .....	67
1.1.1 Doel .....	67
1.2 Verklaring van symbolen .....	67
1.2.1 Gevarenniveaus .....	67
1.2.2 Gevarensymbolen .....	67
1.2.3 Structuur van de waarschuwingen .....	68
1.2.4 Algemene symbolen .....	68
 <b>Veiligheid</b> .....	<b>69</b>
2.1 Algemene veiligheidsinstructies .....	69
2.1.1 Alle huishoudelijke apparaten .....	69
 <b>Gereedschappen en hulpmiddelen</b> .....	<b>70</b>
 <b>Reparatie</b> .....	<b>71</b>
4.1 Deurafdichting vervangen .....	71
4.1.1 Deurafdichting verwijderen .....	71
4.1.2 Deurafdichting monteren .....	71
4.2 Plat scharnier vervangen .....	74
4.2.1 Plat deurscharnier verwijderen .....	74
4.2.2 Plat scharnier monteren .....	75
4.3 Sleepscharnier vervangen .....	76
4.3.1 Sleepscharnier verwijderen .....	76
4.3.2 Sleepscharnier monteren .....	76
4.4 Plateau vervangen .....	77
4.4.1 Plateau verwijderen .....	77
4.4.2 Plateau monteren .....	77
4.5 Deurrek vervangen .....	78
4.5.1 Deurrek verwijderen .....	78
4.5.2 Deurrek monteren .....	78
4.6 Groente- en fruitlade vervangen .....	79
4.6.1 Groente- en fruitlade verwijderen .....	79
4.6.2 Groente- en fruitlade installeren .....	79
4.7 LED-zijlicht vervangen .....	80
4.7.1 LED-zijlicht verwijderen .....	80
4.7.2 LED-zijlicht installeren .....	81

# **i** Over dit document

## 1.1 Belangrijke informatie

### 1.1.1 Doel

Met deze reparatieaanwijzingen wordt de klant geholpen zelf apparaten te repareren conform de toepasselijke verordening inzake ecologisch ontwerp (met ingang van 03/2021).



Ze bevatten informatie over hoe gedefinieerde reserveonderdelen kunnen worden vervangen met inbegrip van waarschuwingen en gevaren.

Neem bij vragen contact op met onze klantenservice. We stellen ons alleen aansprakelijk voor schade als de reparatieaanwijzingen correct zijn opgevolgd.

## 1.2 Verklaring van symbolen

### 1.2.1 Gevarenniveaus

De waarschuwningsniveaus worden aangegeven met een symbool en een signaalwoord. Het signaalwoord geeft de ernst van het gevaar aan.





Waarschuwningsniveau	Betekenis
	Als de waarschuwing niet in acht wordt genomen, leidt dat tot ernstig of dodelijk letsel.
	Als de waarschuwing niet in acht wordt genomen, kan dat tot ernstig of dodelijk letsel leiden.
	Als de waarschuwing niet in acht wordt genomen, kan dat tot licht letsel leiden.
	Als de waarschuwing niet in acht wordt genomen, kan dat tot materiële schade leiden.

Tabel 1: Gevarenniveaus

### 1.2.2 Gevarensymbolen

Gevarensymbolen zijn symbolische afbeeldingen die een indicatie geven van het soort gevaar.

De volgende gevarensymbolen worden in dit document gebruikt:

Gevarensymbool	Betekenis
	Algemene waarschuwing
	Gevaar voor elektrische spanning
	Ontploffingsgevaar
	Snijgevaar

## **i** Over dit document

Gevarensymbool	Betekenis
	Beknellingsgevaar
	Gevaar voor hete oppervlakken
	Gevaar voor sterke magnetische velden
	Gevaar voor niet-ioniserende straling

Tabel 2: Gevarensymbolen

### 1.2.3 Structuur van de waarschuwingen

Waarschuwingen in dit document hebben een gestandaardiseerd uiterlijk en een gestandaardiseerde structuur.







	<div style="background-color: red; color: white; padding: 2px; text-align: center;"><b>⚠ GEVAAR</b></div> <p><b>Soort gevaar en bron van het gevaar!</b> Mogelijke gevolgen van het negeren van het gevaar / de waarschuwing.</p> <ul style="list-style-type: none"> <li>▶ Maatregelen en verboden om het gevaar te voorkomen.</li> </ul>
--	---

In het volgende voorbeeld is een waarschuwing te zien waarmee voor een elektrische schok aan stroomvoerende onderdelen wordt gewaarschuwd. De maatregel om het gevaar te vermijden wordt vermeld.

	<div style="background-color: red; color: white; padding: 2px; text-align: center;"><b>⚠ GEVAAR</b></div> <p><b>Gevaar voor een elektrische schok aan stroomvoerende onderdelen!</b> Dood door elektrocutie</p> <ul style="list-style-type: none"> <li>▶ Haal apparaten minstens 60 seconden voor u met reparaties begint van de stroomvoorziening af.</li> </ul>
--	---

### 1.2.4 Algemene symbolen

De volgende algemene symbolen worden in dit document gebruikt:

Alg. symbool	Betekenis
	Identificatie van een speciale tip (tekst en/of afbeelding)
	Identificatie van een eenvoudige tip (tekst)
	Identificatie van een link naar een video-instructie
	Identificatie van vereiste gereedschappen
	Identificatie van vereiste voorwaarden
	Identificatie van een voorwaarde (als ..., dan ...)
	Identificatie van een resultaat
[Start]	Identificatie van een toets of knop
[00123456]	Identificatie van een materiaalnummer
Status	Identificatie van weergegeven tekst / venster (in het display van het apparaat)

Tabel 3: Algemene symbolen



## 2.1 Algemene veiligheidsinstructies

### 2.1.1 Alle huishoudelijke apparaten

#### **Gevaar voor een elektrische schok aan stroomvoerende onderdelen!**

- Fouten bij reparaties aan elektrische componenten kunnen tot een elektrische schok leiden!
- Koppel het apparaat minstens 60 seconden los van het stroomnet voordat u met de werkzaamheden begint.
- Laat na de reparatie een veiligheidstest conform VDE 0701 of de landspecifieke regelgeving uitvoeren.

#### **Gevaar voor letsel aan scherpe randen!**

- Draag veiligheidshandschoenen.

#### **Beknellingsgevaar tijdens reparatie, onderhoud, probleemoplossing en service vanwege zware en bewegende componenten**

- Draag veiligheidsschoenen.
- Beveilig zware componenten tegen vallen.
- Steek geen lichaamsdelen in bewegende componenten.



#### **Gevaar voor de veiligheid / werking van het apparaat!**

- Gebruik uitsluitend originele reserveonderdelen.

#### **Gevaar voor schade aan elektrostatisch gevoelige componenten (ESD's)!**

- Raak de modules met inbegrip van de aansluitingen en geleiderbanen niet aan.

## Gereedschappen en hulpmiddelen

Benaming	Details	Afbeeldingen
Beschermdoek [00342013]	60 cm x 50 cm	
Zuignap [00342224]	Ø50 mm	
Torxbit TX20 [00340865]	6,3 mm (1/4")	

## 4.1 Deurafdichting vervangen

Voorwaarde:

- ✔ Deur is open.

### 4.1.1 Deurafdichting verwijderen

1. Haal deurafdichting los uit de sleuf in de rechter- en linkerhoek.

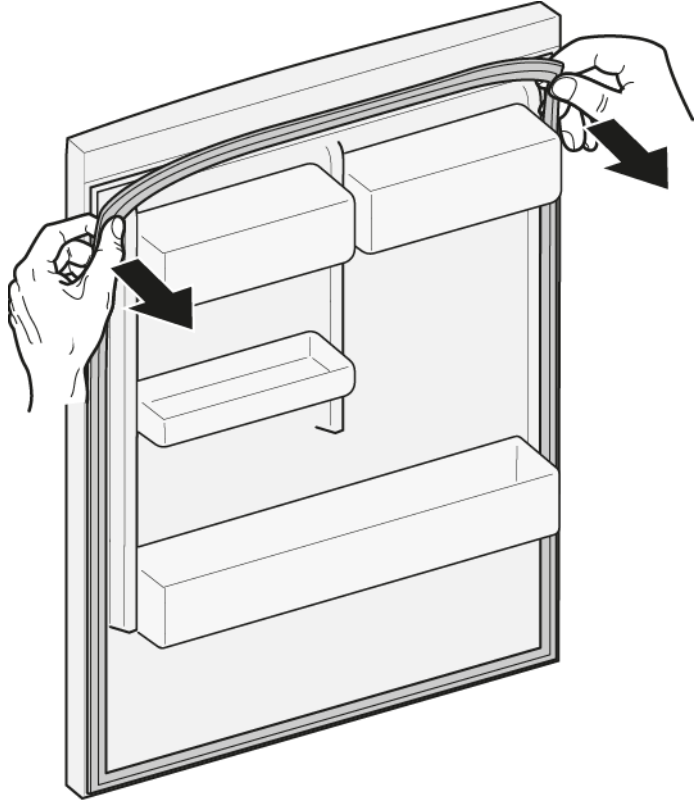

2. Trek deurafdichting uit gleuf.



- ➡ Deurafdichting wordt verwijderd.

### 4.1.2 Deurafdichting monteren



De dikte van de nieuwe deurafdichting kan licht afwijken van de dikte van de oude deurafdichting. Dit doet geen afbreuk aan de sluiteigenschappen en de werking op de lange termijn.

Als uw apparaat verstelbare scharnieren of scharnierbevestigingen heeft, kunt u de sluiteigenschappen later optimaliseren.

De zijgaatjes in de deurafdichting zijn functioneel (vereist voor ventilatie). Dit zijn geen productiefouten.

## Reparatie

1. Controleer de sleuf voor de afdichting op schade.

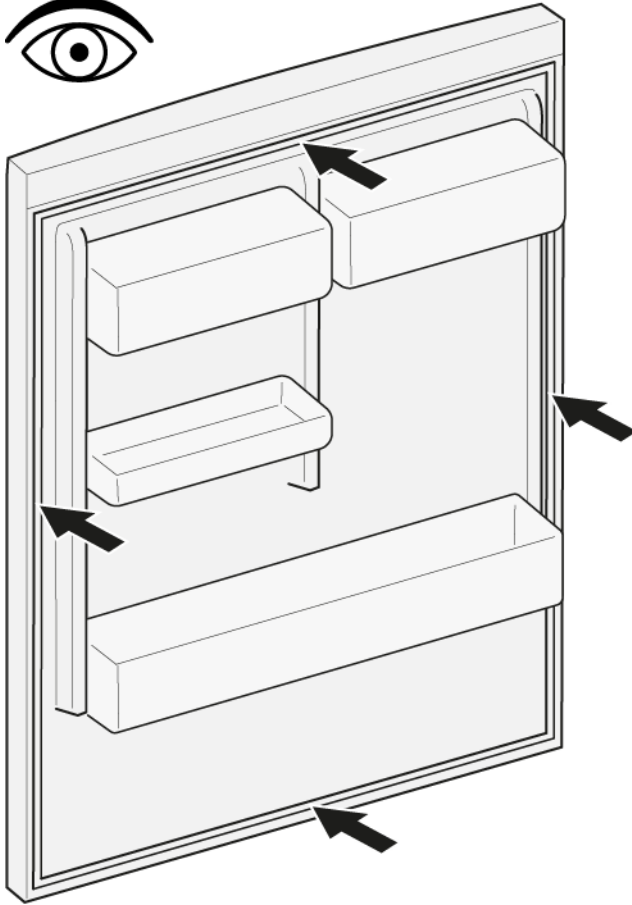

4. Duw de hoeken van de afdichting bovenaan en onderaan in de sleuf.

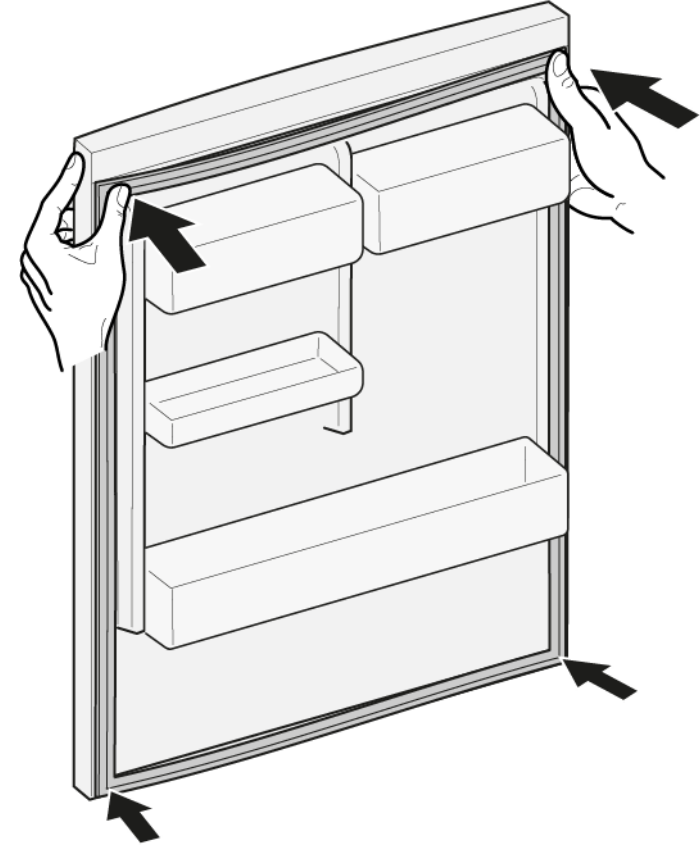

2.  Als de sleuf voor de afdichting is beschadigd:
  - Neem contact op met de klantenservice.

3.  Een lichte vervorming van de deurafdichting is normaal en doet geen afbreuk aan de werking. Geadviseerd wordt de deurafdichting recht te trekken voordat u deze in het apparaat steekt.

Verwarm de deurafdichting met een haardroger of met warm water en breng het handmatig terug in zijn vorm.

## Reparatie

5. Druk de hele afdichting stap voor stap in de sleuf.



 De deurafdichting wordt gemonteerd.

## 4.2 Plat scharnier vervangen

### Speciale hulpmiddelen:

Torxbit TX20

6,3 mm (1/4")

[00340865]

	<b>WAARSCHUWING</b>
	<p><b>Zware, omvangrijke apparaten!</b> Rug- en spierletsel</p> <ul style="list-style-type: none"> <li>▶ De werkzaamheid van het verwijderen van de apparaatdeur mag alleen worden uitgevoerd door speciaal opgeleid personeel.</li> <li>▶ Om het apparaat te verplaatsen zijn twee mensen nodig.</li> <li>▶ Gebruik alleen geschikte gereedschappen en apparatuur.</li> </ul>

	<b>VOORZICHTIG</b>
	<p><b>Scherpe randen!</b> Snijletsel</p> <ul style="list-style-type: none"> <li>▶ Draag veiligheidshandschoenen.</li> </ul>

	<b>VOORZICHTIG</b>
	<p><b>Maak het scharniergedeelte open!</b> Beknelling/afklemming van vingers</p> <ul style="list-style-type: none"> <li>▶ Steek uw vingers niet in het scharniergedeelte.</li> <li>▶ Draag veiligheidshandschoenen.</li> </ul>

	<b>VOORZICHTIG</b>
	<p><b>Gevaar voor vallende onderdelen als gevolg van losgeraakte schroeven!</b> Letsel als gevolg van vallende onderdelen.</p> <ul style="list-style-type: none"> <li>▶ Beveilig component tegen vallen.</li> </ul>

	<b>LET OP!</b>
	<p><b>Gevaar voor vallende onderdelen als gevolg van losgeraakte schroeven!</b> Schade aan andere onderdelen van het apparaat of bij de klant thuis bijvoorbeeld aan de vloer.</p> <ul style="list-style-type: none"> <li>▶ Beveilig component tegen vallen.</li> </ul>

### Voorwaarde:

- ✔ Apparaat is losgekoppeld is van de stroomvoorziening.

- ✔ Meubeldeur wordt verwijderd. Zie montage-instructie.

- ✔ Deur is open.

### 4.2.1 Plat deurscharnier verwijderen

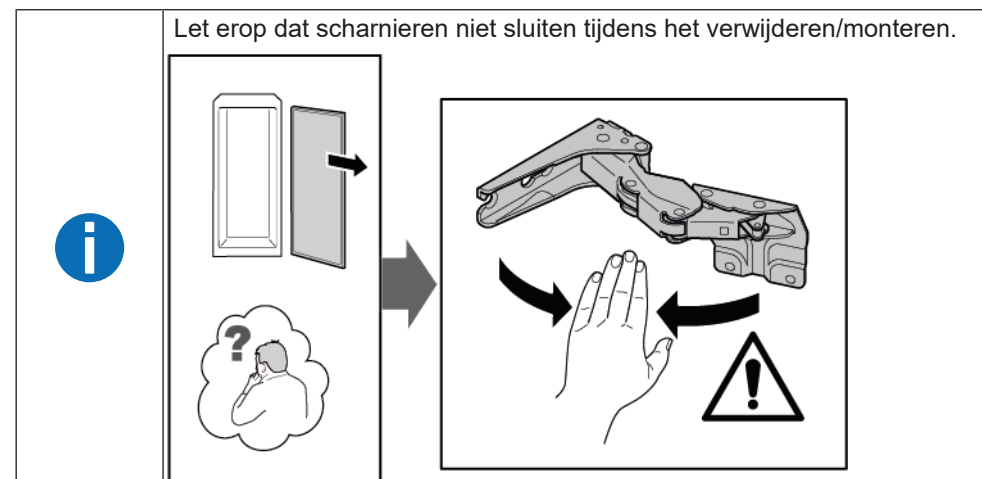

1. Verwijder twee scharnierafdekkingen.

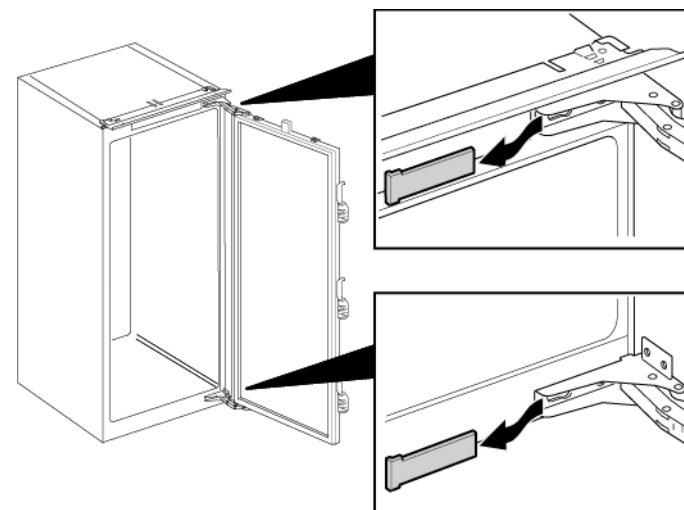

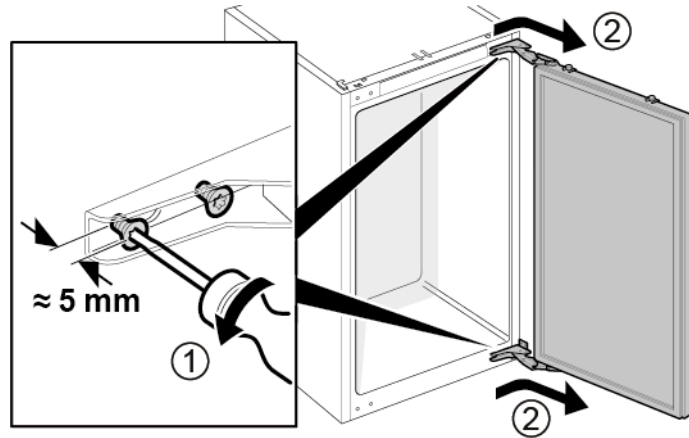

## Reparatie

1. Draai vier schroeven los (1).
2. Schuif de deur eruit en verwijder hem (2).

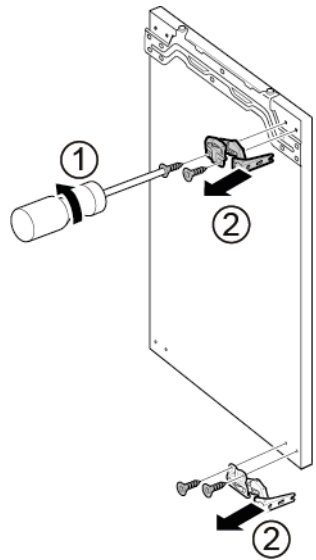

1. Verwijder vier schroeven (1).
2. Verwijder scharnieren (2).



 Scharnieren worden verwijderd.

### 4.2.2 Plat scharnier monteren

- ▶ Monteer in omgekeerde volgorde.

## 4.3 Sleepscharnier vervangen

### Speciale hulpmiddelen:

Torxbit TX20 6,3 mm (1/4") [00340865]

	<b>WAARSCHUWING</b> <b>Zware, omvangrijke apparaten!</b> Rug- en spierletsel ▶ De werkzaamheid van het verwijderen van de apparaatdeur mag alleen worden uitgevoerd door speciaal opgeleid personeel. ▶ Om het apparaat te verplaatsen zijn twee mensen nodig. ▶ Gebruik alleen geschikte gereedschappen en apparatuur.
	<b>VOORZICHTIG</b> <b>Scherpe randen!</b> Snijletsel ▶ Draag veiligheidshandschoenen.
	<b>VOORZICHTIG</b> <b>Gevaar voor vallende onderdelen als gevolg van losgeraakte schroeven!</b> Letsel als gevolg van vallende onderdelen. ▶ Beveilig component tegen vallen.
	<b>LET OP!</b> <b>Gevaar voor vallende onderdelen als gevolg van losgeraakte schroeven!</b> Schade aan andere onderdelen van het apparaat of bij de klant thuis bijvoorbeeld aan de vloer. ▶ Beveilig component tegen vallen.

### Voorwaarde:

- ✔ Apparaat is losgekoppeld van de stroomvoorziening.
- ✔ Meubeldeur en apparaatdeur zijn gescheiden. Zie montage-instructie.

### 4.3.1 Sleepscharnier verwijderen

- ▶ 1. Draai de twee schroeven los (1).
- ▶ 2. Verwijder het bovenste scharnier (2).
- ▶ 3. Verwijder de deur (3).
- ▶ 4. Draai de twee schroeven los (4).
- ▶ 5. Verwijder het onderste scharnier (5).

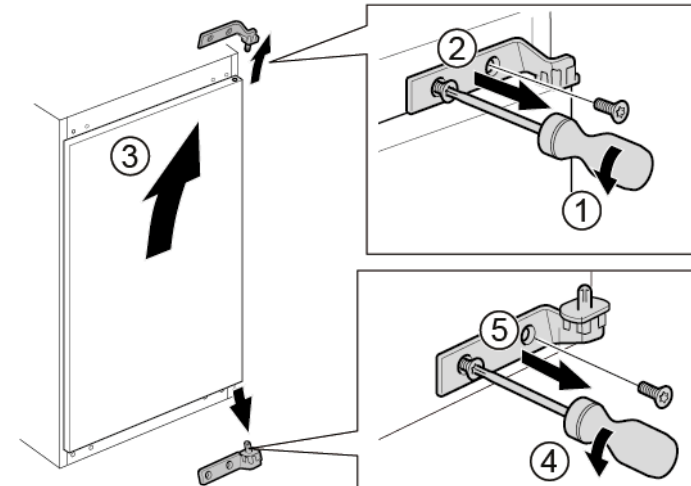

- ➡ Scharnieren worden verwijderd.

### 4.3.2 Sleepscharnier monteren

- ▶ Monteer in omgekeerde volgorde.



## 4.4 Plateau vervangen

Voorwaarde:

- ✔ Deur is open.

### 4.4.1 Plateau verwijderen

- ▶ Trek het plateau eruit.



➡ Plateau wordt verwijderd.

### 4.4.2 Plateau monteren

- ▶ Monteer in omgekeerde volgorde.

## 4.5 Deurrek vervangen

Voorwaarde:

- ✔ Deur is open.

### 4.5.1 Deurrek verwijderen

- ▶ Licht het deurrek omhoog.

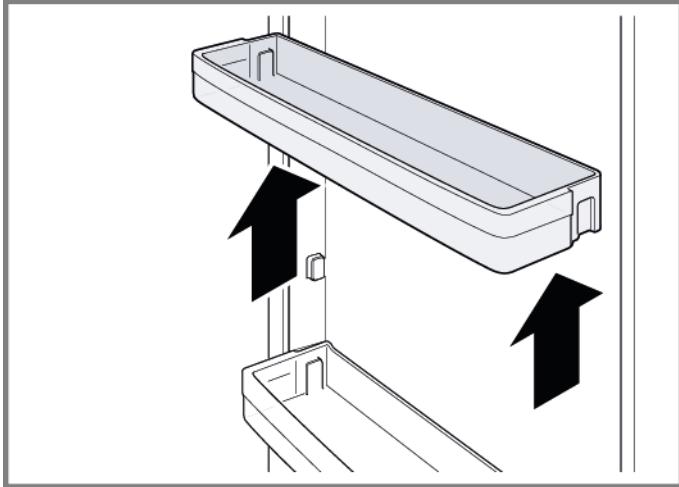

➡ Deurrek wordt verwijderd.

### 4.5.2 Deurrek monteren

- ▶ Monteer in omgekeerde volgorde.

## 4.6 Groente- en fruitlade vervangen

Voorwaarde:

- ✔ Deur is open.

### 4.6.1 Groente- en fruitlade verwijderen

1. Trek de groente- en fruitlade zo ver mogelijk naar buiten.
2. 1. Til de groente- en fruitlade aan de voorkant op (1).  
2. Verwijder de lade (2).



- ➔ De groente- en fruitlade wordt verwijderd.

### 4.6.2 Groente- en fruitlade installeren

- ▶ Monteer in omgekeerde volgorde.

## 4.7 LED-zijlicht vervangen

### Speciale hulpmiddelen:

Zuignap Ø50 mm [00342224]

**i** Uw apparaat heeft een onderhoudsvrije LED-verlichting. Deze verlichting mag alleen maar door de klantenservice of geautoriseerde monteurs worden vervangen!

**⚠ GEVAAR**  
**Gevaar voor een elektrische schok aan stroomvoerende onderdelen!**  
Levensgevaar door elektrische schokken in geval van een ondeskundige reparatie

- ▶ Elektrische onderdelen moeten door gekwalificeerde elektriciens worden gerepareerd.
- ▶ Laat na de reparatie een veiligheidstest conform VDE 0701 of de landspecifieke regelgeving uitvoeren.

**⚠ GEVAAR**  
**Gevaar voor een elektrische schok aan stroomvoerende onderdelen!**  
Dood door elektrocutie

- ▶ Haal apparaten minstens 60 seconden voor u met reparaties begint van de stroomvoorziening af.

**⚠ VOORZICHTIG**  
**Scherpe randen!**  
Snijletsel

- ▶ Draag veiligheidshandschoenen.

### Voorwaarde:

- ✓ Apparaat is losgekoppeld is van de stroomvoorziening.
- ✓ Deur is open.
- ✓ Plateaus worden verwijderd.

### 4.7.1 LED-zijlicht verwijderen

1. Plak twee zuignappen op de afdekking van het LED-zijlicht.

2. Trek de zuignappen in één draaiende beweging naar voren.

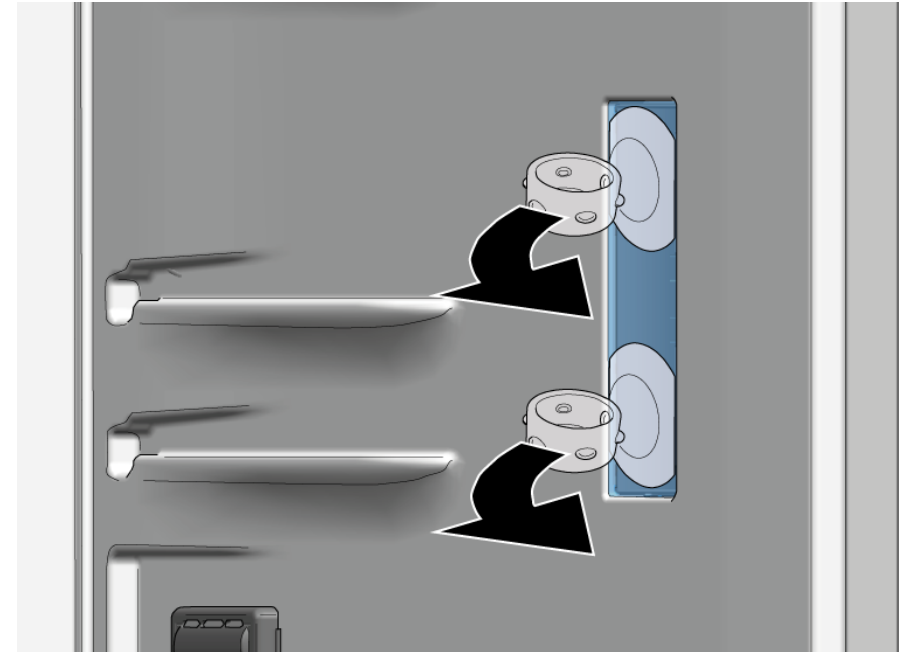

- ➔ Afdekking van het LED-licht wordt verwijderd.

3. Verwijder de LED-module.



 LED-zijlicht wordt verwijderd.





### 4.7.2 LED-zijlicht installeren



Door de lampafdekking kunnen haken gemakkelijk breken tijdens het verwijderingsproces. Reserveonderdeel LED-zijlicht is de set die ook de LED-module en lichtafdekking bevatten.

► Monteer in omgekeerde volgorde.

# Self-repair hints - Refrigerator

 <b>Concerning this document</b> .....	<b>83</b>
1.1 Important information .....	83
1.1.1 Purpose.....	83
1.2 Explanation of symbols .....	83
1.2.1 Danger levels.....	83
1.2.2 Hazard symbols .....	83
1.2.3 Structure of the warnings.....	84
1.2.4 General symbols.....	84
 <b>Safety</b> .....	<b>85</b>
2.1 General Safety instructions .....	85
2.1.1 All domestic appliances .....	85
 <b>Tools and aids</b> .....	<b>86</b>
 <b>Repair</b> .....	<b>87</b>
4.1 Replacing door gasket .....	87
4.1.1 Removing door gasket.....	87
4.1.2 Installing door gasket .....	87
4.2 Replacing flat hinge .....	90
4.2.1 Removing flat hinge .....	90
4.2.2 Installing flat hinge .....	91
4.3 Replacing sliding hinge .....	92
4.3.1 Removing sliding hinge .....	92
4.3.2 Installing sliding hinge .....	92
4.4 Replacing shelf.....	93
4.4.1 Removing shelf.....	93
4.4.2 Installing shelf.....	93
4.5 Replacing door rack.....	94
4.5.1 Removing door rack .....	94
4.5.2 Installing door rack.....	94
4.6 Replacing fruit and vegetable container .....	95
4.6.1 Removing fruit and vegetable container.....	95
4.6.2 Installing fruit and vegetable container.....	95
4.7 Replacing LED side light .....	96
4.7.1 Removing LED side light .....	96
4.7.2 Installing LED side light .....	97

# **i** Concerning this document

## 1.1 Important information

### 1.1.1 Purpose

These repair hints support consumer to repair appliances by himself according to the applicable eco-design regulation (as of 03/2021).

They contain information how to exchange defined spare parts including warnings and risks.

In case of questions, please contact our customer service. We will only be liable for damages if the repair hints have been followed properly.

## 1.2 Explanation of symbols

### 1.2.1 Danger levels

The warning levels consist of a symbol and a signal word. The signal word indicates the severity of the danger.









Warning level	Meaning
 <b>Danger</b>	Non-observance of the warning message will result in death or serious injuries.
 <b>Warning</b>	Non-observance of the warning message could result in death or serious injuries.
 <b>Caution</b>	Non-observance of the warning message could result in minor injuries.
 <b>Notice</b>	Non-observance of the warning message could result in damage to property.

Table 1: Danger levels

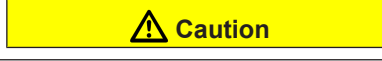
### 1.2.2 Hazard symbols

Hazard symbols are symbolic representations which give an indication of the kind of danger.

The following hazard symbols are used in this document:

Hazard symbol	Meaning
	General warning message
	Danger from electrical voltage
	Risk of explosion
	Danger of cuts
	Danger of crushing

## **i** Concerning this document



Hazard symbol	Meaning
	Danger from hot surfaces
	Danger from strong magnetic field
	Danger from non-ionizing radiation

Table 2: Hazard symbols

### 1.2.3 Structure of the warnings

Warnings in this document have a standardised appearance and a standardised structure.



	<div style="background-color: red; color: white; padding: 2px; text-align: center;"> <b>Danger</b></div> <p><b>Type and source of danger!</b> Possible consequences of ignoring the danger / warning.</p> <ul style="list-style-type: none"> <li>▶ Measures and prohibitions for preventing the danger.</li> </ul>
--	---

The following example shows a warning that warns against electric shock due to live parts. The measure for avoiding the danger is mentioned.

	<div style="background-color: red; color: white; padding: 2px; text-align: center;"> <b>Danger</b></div> <p><b>Risk of electric shock due to live parts!</b> Death by electrocution</p> <ul style="list-style-type: none"> <li>▶ Disconnect appliances from electrical supply at least 60 seconds before starting repairs.</li> </ul>
---	---

### 1.2.4 General symbols

The following general symbols are used in this document:

Gen. symbol	Meaning
	Identification of a special tip (text and/or graphic)
	Identification of a simple tip (only text)
	Identification of a link to a video tutorial





Gen. symbol	Meaning
	Identification of required tools
	Identification of required preconditions
	Identification of a condition (if ..., then ...)
	Identification of a result
[Start]	Identification of a key or button
[00123456]	Identification of a material number
Status	Identification of displayed text / window (in the appliance's display)

Table 3: General symbols



## 2.1 General Safety instructions

### 2.1.1 All domestic appliances

#### **Risk of electric shock due to live parts!**

- Errors by repairs involving electrical components can lead to electrical shock!
- Disconnect the appliance from the mains for at least 60 seconds before starting work.
- After the repair have a safety test according VDE 0701 or country-specific regulations performed.

#### **Risk of injury from sharp edges!**

- Wear protective gloves.

#### **Risk of crushing during repair, maintenance, troubleshooting and service due to heavy and moving components**

- Wear protective shoes.
- Secure heavy components from falling down.
- Do not stick body parts into moving components.



#### **Risk to the appliance's safety / function!**

- Only use original spare parts.

#### **Risk of damage to electrostatically sensitive components (ESDs)!**

- Do not touch the modules, including connections and conductor paths.

## Tools and aids

Designation	Details	Images
Protection cloth [00342013]	60 cm x 50 cm	
Suction cup [00342224]	Ø50 mm	
Torx Bit TX20 [00340865]	6,3 mm (1/4")	

## 4.1 Replacing door gasket

### Prerequisite:

- ✔ Door is open.

### 4.1.1 Removing door gasket

1. Release door gasket from the groove on right and left corner.

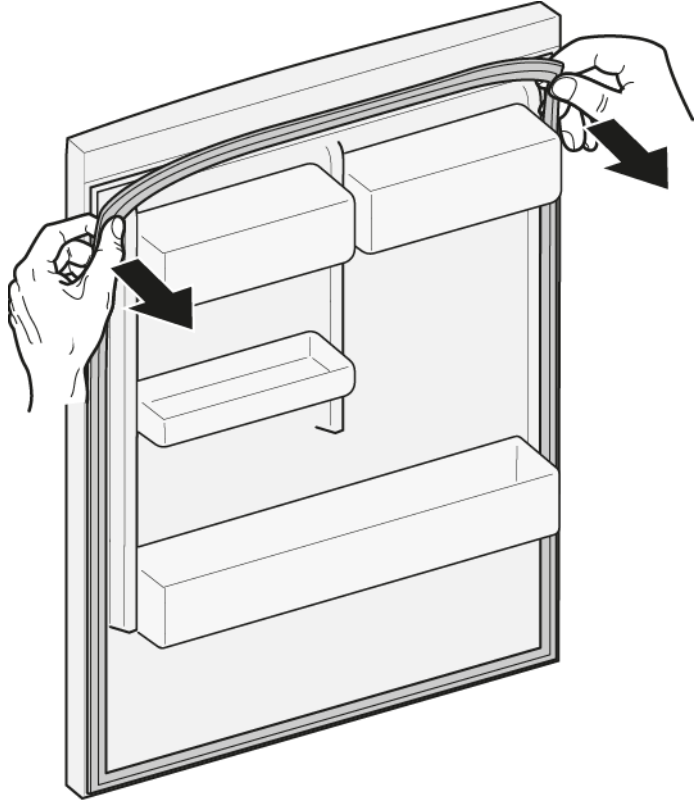

2. Pull out door gasket from groove.

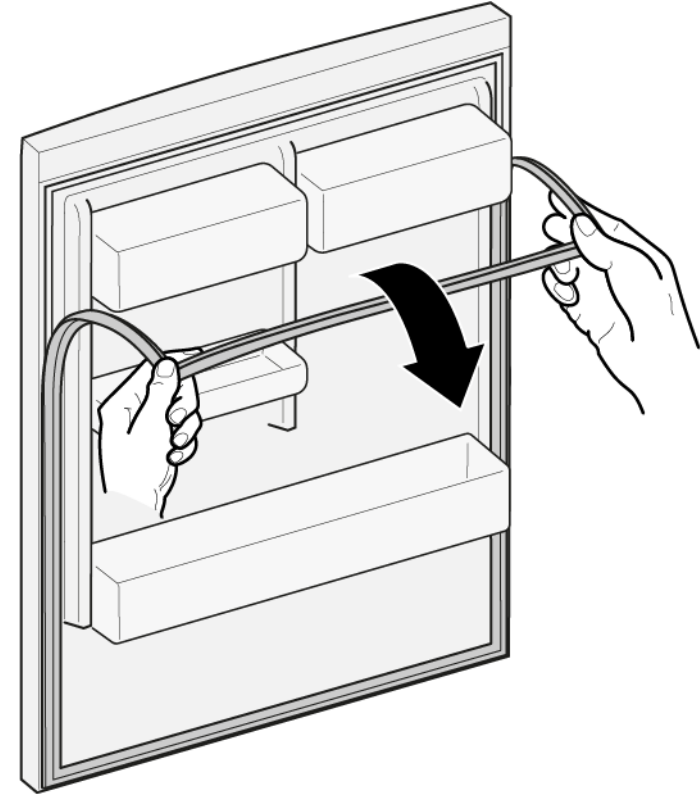

- ➡ Door gasket is removed.

### 4.1.2 Installing door gasket



Thickness of new door gasket may deviate slightly from thickness of old door gasket. This will not affect closing behavior and long-term function. If your appliance has adjustable hinges or hinge attachments, you can optimize the closing behavior subsequently. Small side holes in door gasket are functional (required for ventilation). These are not production faults.

## Repair

1. Check groove for gasket for damage.

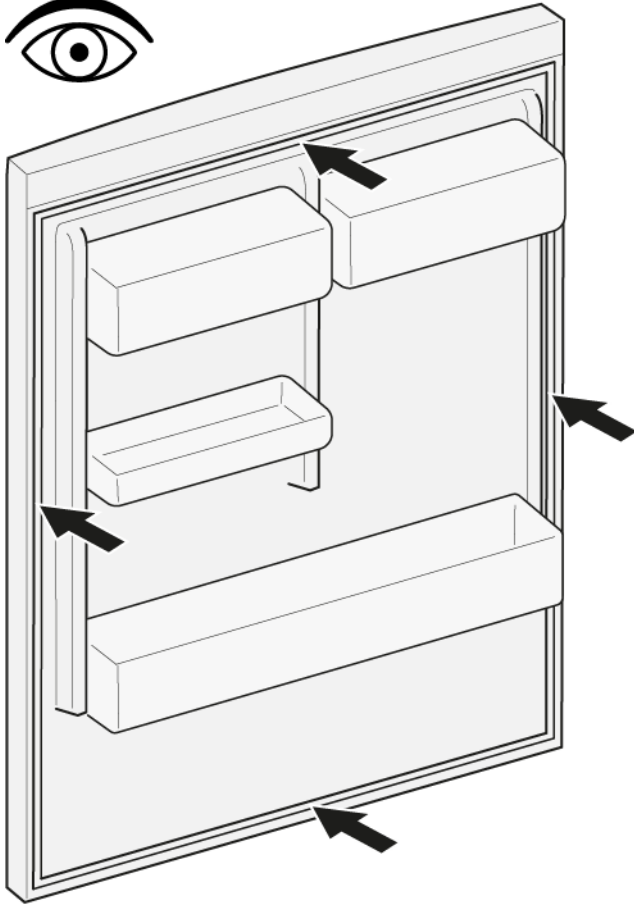

4. Push corners of gasket at the top and bottom to the groove.

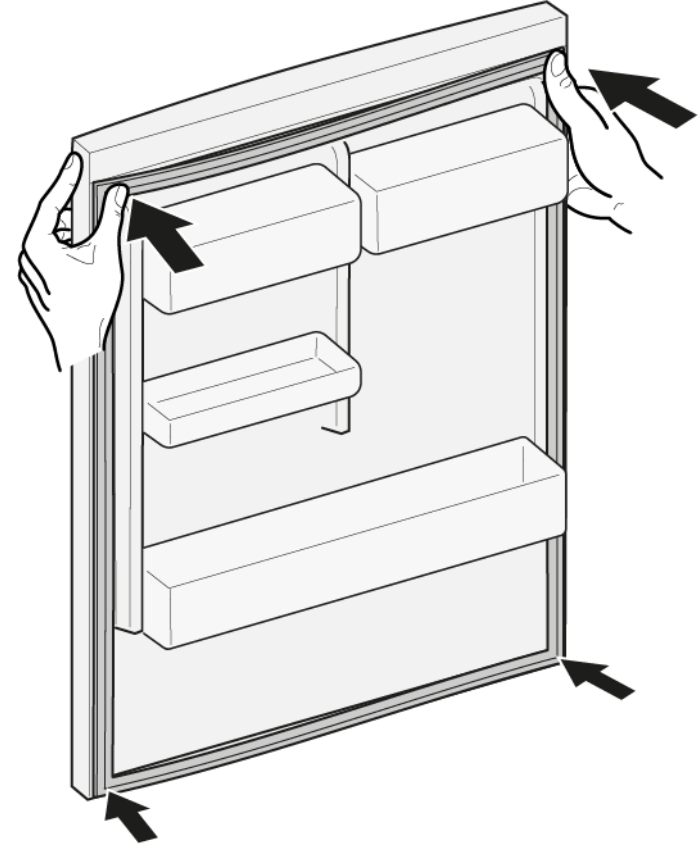

2.  If groove for gasket is it is damaged.  
- Contact customer service.

3.  Slight deformation of door gasket is normal and does not affect its function. It is recommended to straighten door gasket before inserting it into appliance.

Heat door gasket with a hair dryer or hot water and manually reshape it.

5. Press whole gasket step by step into the groove.

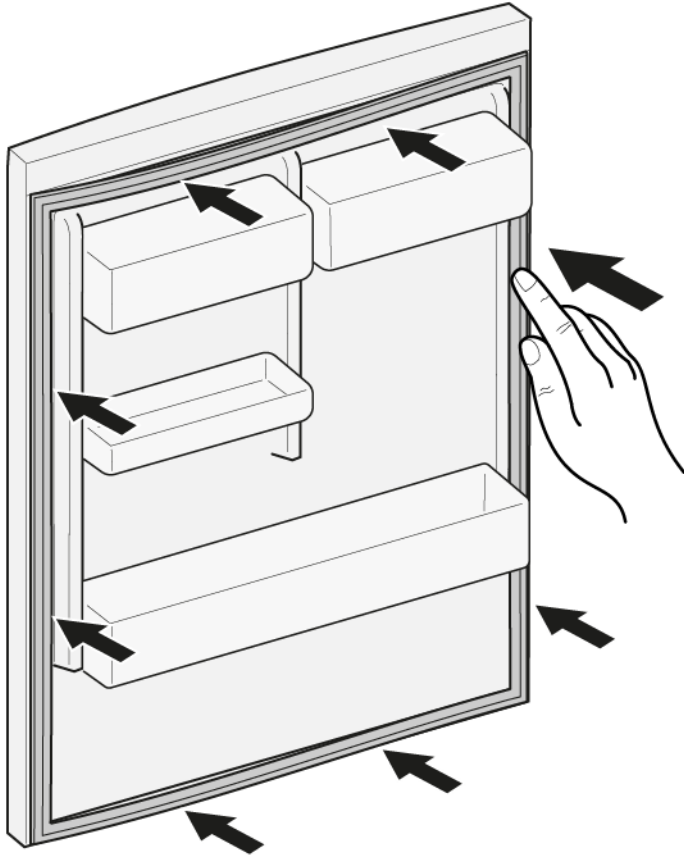

-  Door gasket is installed.

## 4.2 Replacing flat hinge

### Required tools:

 Torx Bit TX20

6,3 mm (1/4")

[00340865]



### Warning

#### Heavy, bulky appliances!

Back and muscle injuries

- ▶ Appliance door removal operation should only be carried out by trained specialists.
- ▶ To move the appliance, two people are required.
- ▶ Use only suitable tools and equipment.



### Caution

#### Sharp edges!

Cut injuries

- ▶ Wear protective gloves.



### Caution

#### Open hinge area!

Finger crushing / entrapment

- ▶ Do not reach into the hinge area.
- ▶ Wear protective gloves.



### Caution

#### Risk of falling parts due to released screws!

Injury because of falling parts.

- ▶ Secure component from falling down.





### Notice

#### Risk of falling parts due to released screws!

Damage to other parts of the appliance or at customers home e.g. bottom.

- ▶ Secure component from falling down.

### Prerequisite:

-  Appliance is disconnected from power supply.
-  Furniture door is removed. See Installation Instruction.
-  Door is open.

## 4.2.1 Removing flat hinge

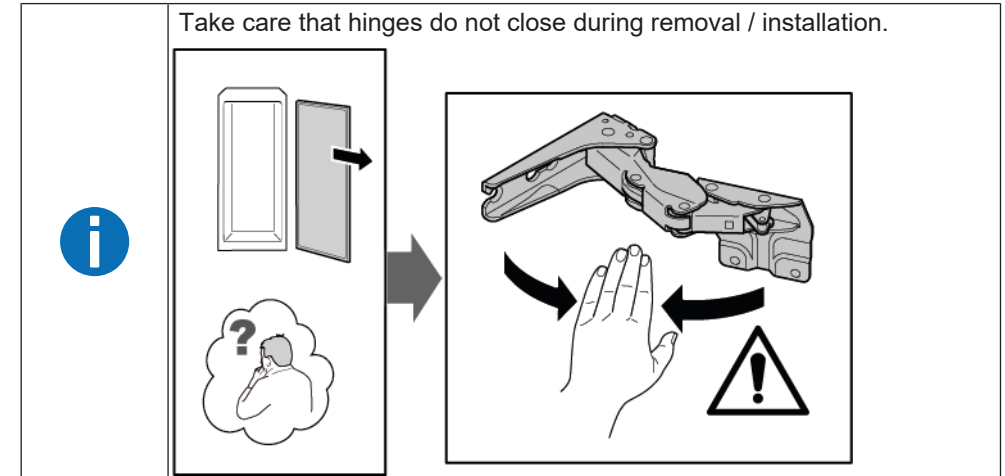

1. Remove two hinge covers.

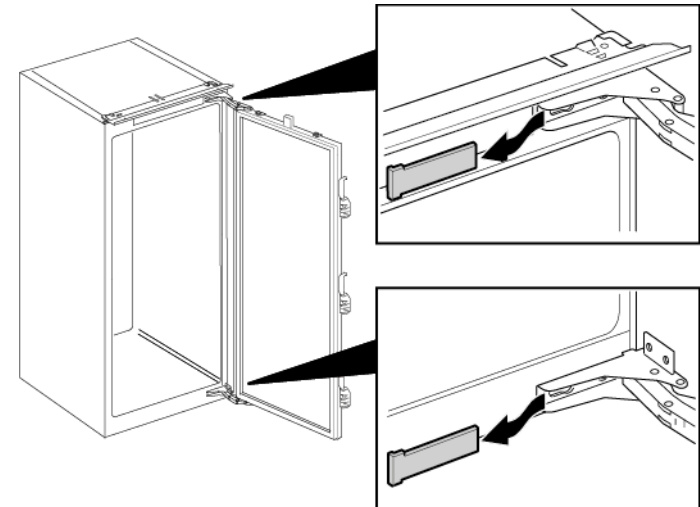



## Repair

1. Loosen four screws (1).
2. Slide out and remove door (2).

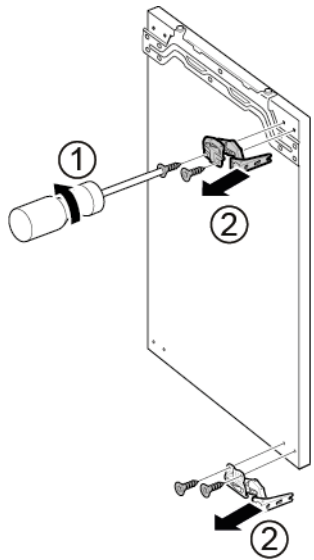

1. Remove four screws (1).
2. Remove hinges (2).



 Hinges are removed.

### 4.2.2 Installing flat hinge

- ▶ Install in reverse order.

## 4.3 Replacing sliding hinge

### Required tools:

 Torx Bit TX20                      6,3 mm (1/4")                      [00340865]



	<b>Warning</b>
	<p><b>Heavy, bulky appliances!</b> Back and muscle injuries</p> <ul style="list-style-type: none"> <li>▶ Appliance door removal operation should only be carried out by trained specialists.</li> <li>▶ To move the appliance, two people are required.</li> <li>▶ Use only suitable tools and equipment.</li> </ul>

	<b>Caution</b>
	<p><b>Sharp edges!</b> Cut injuries</p> <ul style="list-style-type: none"> <li>▶ Wear protective gloves.</li> </ul>

	<b>Caution</b>
	<p><b>Risk of falling parts due to released screws!</b> Injury because of falling parts.</p> <ul style="list-style-type: none"> <li>▶ Secure component from falling down.</li> </ul>

	<b>Notice</b>
	<p><b>Risk of falling parts due to released screws!</b> Damage to other parts of the appliance or at customers home e.g. bottom.</p> <ul style="list-style-type: none"> <li>▶ Secure component from falling down.</li> </ul>

### Prerequisite:

-  Appliance is disconnected from power supply.
-  Furniture door and appliance door are separated. See Installation Instruction.

### 4.3.1 Removing sliding hinge

- ▶ 1. Unscrew two screws (1).
- ▶ 2. Remove upper hinge (2).
- ▶ 3. Remove door (3).
- ▶ 4. Unscrew two screws (4).
- ▶ 5. Remove lower hinge (5).

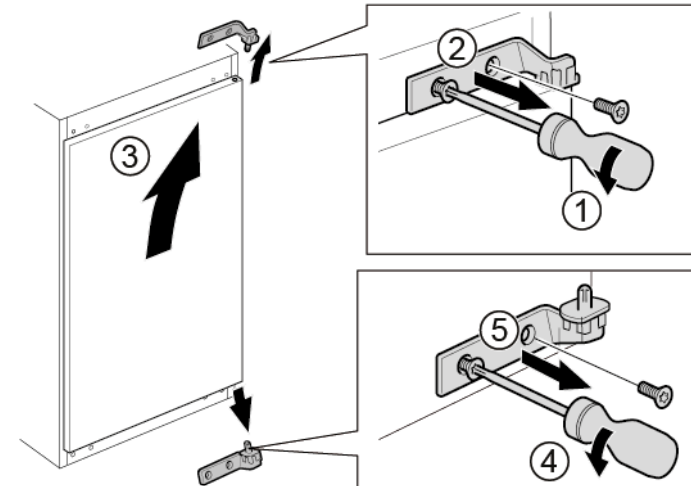

 Hinges are removed.

### 4.3.2 Installing sliding hinge

- ▶ Install in reverse order.



## 4.4 Replacing shelf

### Prerequisite:

- ✔ Door is open.

### 4.4.1 Removing shelf

- ▶ Pull out shelf.



- ➡ Shelf is removed.

### 4.4.2 Installing shelf

- ▶ Install in reverse order.

## 4.5 Replacing door rack

### Prerequisite:

- ✔ Door is open.

### 4.5.1 Removing door rack

- ▶ Lift door rack upwards.



- ➡ Door rack is removed.

### 4.5.2 Installing door rack

- ▶ Install in reverse order.

## 4.6 Replacing fruit and vegetable container

### Prerequisite:

- ✔ Door is open.

### 4.6.1 Removing fruit and vegetable container

1. Pull out the fruit and vegetable container as far as it will go.
2. 1. Lift the fruit and vegetable container at the front (1).  
2. Remove container (2).



- ➔ Fruit and vegetable container is removed.

### 4.6.2 Installing fruit and vegetable container

- ▶ Install in reverse order.

## 4.7 Replacing LED side light

### Required tools:

☞ Suction cup Ø50 mm [00342224]

**i** Your appliance features a maintenance-free LED light. These lights may be repaired by customer service or authorised technicians only!

**⚠ Danger**  
**Risk of electric shock due to live parts!**  
 Danger to life through electric shock in case of improper repair

- ▶ Electric parts should be repaired by a qualified electricians.
- ▶ After the repair have a safety test according VDE 0701 or country-specific regulations performed.

**⚠ Danger**  
**Risk of electric shock due to live parts!**  
 Death by electrocution

- ▶ Disconnect appliances from electrical supply at least 60 seconds before starting repairs.

**⚠ Caution**  
**Sharp edges!**  
 Cut injuries

- ▶ Wear protective gloves.

### Prerequisite:

- ✓ Appliance is disconnected from power supply.
- ✓ Door is open.
- ✓ Shelves are removed.

### 4.7.1 Removing LED side light

1. Stick two suction cup on LED side light cover.

2. Pull suction cups forward in one rotary movement.

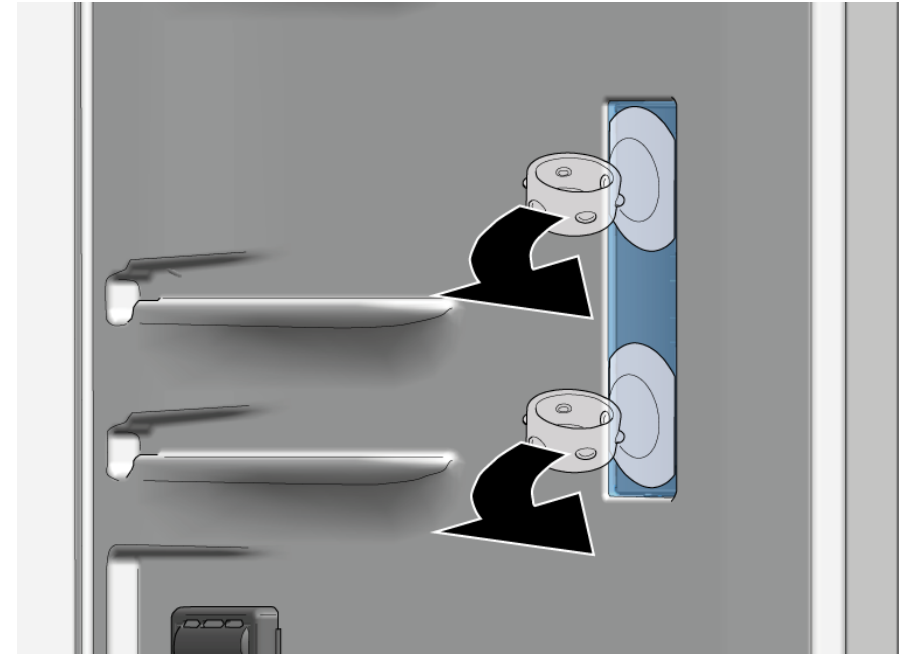

➡ LED light cover is removed.

3. Remove LED module.



 LED side light is removed.

## 4.7.2 Installing LED side light



Due to lamp cover hooks are easy to break during removal process spare part LED side light is the set that includes LED module and light cover.

▶ Install in reverse order.

# Remonditeave - Külmik

 <b>Selle dokumendiga seoses .....</b>	<b>99</b>
1.1 Tähtis teave .....	99
1.1.1 Eesmärk.....	99
1.2 Sümbolite selgitus .....	99
1.2.1 Ohutasemed.....	99
1.2.2 Ohusümbolid .....	99
1.2.3 Hoiatuste struktuur.....	100
1.2.4 Üldised sümbolid.....	100
 <b>Ohutus.....</b>	<b>101</b>
2.1 Üldised ohutusjuhised.....	101
2.1.1 Kõik kodumasinad.....	101
 <b>Tööriistad ja abinõud.....</b>	<b>102</b>
 <b>Remont.....</b>	<b>103</b>
4.1 Uksetihendi vahetamine.....	103
4.1.1 Uksetihendi eemaldamine .....	103
4.1.2 Uksetihendi paigaldamine.....	103
4.2 Tasapinnalise hinge vahetamine .....	106
4.2.1 Tasapinnalise hinge eemaldamine .....	106
4.2.2 Tasapinnalise hinge paigaldamine .....	107
4.3 Lükandhinge vahetamine .....	108
4.3.1 Lükandhinge eemaldamine.....	108
4.3.2 Lükandhinge paigaldamine .....	108
4.4 Riiuli vahetamine .....	109
4.4.1 Riiuli eemaldamine.....	109
4.4.2 Riiuli paigaldamine .....	109
4.5 Ukseraami vahetamine .....	110
4.5.1 Ukseraami eemaldamine .....	110
4.5.2 Ukseraami paigaldamine .....	110
4.6 Puu- ja köögiviljamahuti vahetamine.....	111
4.6.1 Puu- ja köögiviljamahuti eemaldamine.....	111
4.6.2 Puu- ja köögiviljamahuti paigaldamine.....	111
4.7 Külgmise LED-tule vahetamine.....	112
4.7.1 Külgmise LED-tule eemaldamine .....	112
4.7.2 Külgmise LED-tule paigaldamine .....	113

# **i** Selle dokumendiga seoses

## 1.1 Tähtis teave

### 1.1.1 Eesmärk

Need remondinõuanded toetavad tarbijat seadmete iseseisval remontimisel vastavalt kehtivale ökodisaini määrusele (03/2021).





Need sisaldavad teavet selle kohta, kuidas vahetada teatud varuosi, samuti hoiatusi ning ohtusid.

Küsimuste korral võtke ühendust meie klienditeenindusega. Meie vastutame kahjustuste eest ainult siis, kui remondinõuandeid on õigesti järgitud.

## 1.2 Sümbolite selgitus

### 1.2.1 Ohutasemed

Ohutasemed koosnevad sümbolist ja märksõnast. Märksõna viitab ohu raskusastmele.

Hoiatustase	Tähendus
 <b>OHT</b>	Hoiatusteadete eiramine põhjustab surma või raskeid kehavigastusi.
 <b>HOIATUS</b>	Hoiatusteadete eiramine võib põhjustada surma või raskeid kehavigastusi.
 <b>ETTEVAATUST!</b>	Hoiatusteadete eiramine võib põhjustada kergeid kehavigastusi.
 <b>TÄHELEPANU!</b>	Hoiatusteadete eiramine võib põhjustada varakahju.

Tabel 1: Ohutasemed



### 1.2.2 Ohusümbolid

Ohusümbolid on sümboolsed kujutised, mis viitavad ohu laadile.

Selles dokumendis kasutatakse alljärgnevaid ohusümboleid.

Ohusümbol	Tähendus
	Üldine ohuteade
	Elektripingest tingitud oht
	Plahvatusoht
	Lõikeoht
	Muljumisoht

## **i** Selle dokumendiga seoses

Ohusümbol	Tähendus
	Kuumadest pindadest tingitud oht
	Tugevast magnetväljast tingitud oht
	Mitteioniseerivast kiirgusest tingitud oht

Tabel 2: Ohusümbolid

### 1.2.3 Hoiatuste struktuur

Selles dokumendis olevatel hoiatustel on standardiseeritud väljanägemine ja standardiseeritud struktuur.



	<div style="background-color: red; color: white; padding: 2px; display: inline-block;"><b>⚠ OHT</b></div> <b>Ohu tüüp ja allikas!</b> Ohu/hoiatuse eiramise võimalikud tagajärjed. ▶ Meetmed ja ettevaatusabinõud ohu vältimiseks.
--	---





Alljärgnevas näiteks on näidatud hoiatust, millega hoiatatakse liikuvatest osadest tingitud elektrilöögiu eest. Nimetatud on meetet ohu vältimiseks.

	<div style="background-color: red; color: white; padding: 2px; display: inline-block;"><b>⚠ OHT</b></div> <b>Liikuvatest osadest tingitud elektrilöögi oht!</b> Elektrilöögist tingitud surm ▶ Enne remonditöödega alustamist ühendage seadmed elektrivõrgust lahti vähemalt 60 sekundit varem.
---	--

### 1.2.4 Üldised sümbolid

Selles dokumendis kasutatakse alljärgnevaid üldisi sümboleid.

Üld. sümbol	Tähendus
	Erinõuande tunnus (tekst ja/või graafik)
	Lihtsa nõuande tunnus (ainult tekst)
	Videojuhendi lingi tunnus

Üld. sümbol	Tähendus
	Vajalike tööriistade tunnus
	Vajalike eeltingimuste tunnus
	Seisukorra tunnus (kui..., siis...)
	Tulemuse tunnus
[Start]	Klahvi või nupu tunnus
[00123456]	Materjalinumbr tunnus
Olek	Kuvatava teksti/akna tunnus (seadme ekraanil)

Tabel 3: Üldised sümbolid



## 2.1 Üldised ohutusjuhised

### 2.1.1 Kõik kodumasinad

#### **Liikuvatest osadest tingitud elektrilöögi oht!**

- Elektriliste osade remondil tehtud vead võivad põhjustada elektrilööki!
- Lahutage seade vooluvõrgust vähemalt 60 sekundit enne tööle hakkamist.
- Pärast remonti peab olema tehtud ohutuskatse vastavalt standardile VDE 0701 või riiklikele määrustele.

#### **Teravatest servadest tingitud vigastusoht!**

- Kandke kaitsekindaid.

#### **Rasketest ja liikuvatest osadest tingitud muljumisoht remondi-, puhastustööde, tõrkeotsingu ja hoolduse käigus**

- Kandke turvakingi.
- Kinnitage rasked osad allakukkumise vastu.
- Ärge toppige kehaosi liikuvate osade vahele.



#### **Oht seadme ohutusele/talitlusele!**

- Kasutage ainult originaalvaruosasid.

#### **Elektrostaatiliselt tundlike osade (ESD) kahjustamise oht!**

- Ärge puudutage moduleid, kaasa arvatud ühendusi ega transportöörlinte.

## Tööriistad ja abinõud

Määramine	Üksikasjad	Kujutised
Kaitseriie [00342013]	60 cm × 50 cm	
Iminapp [00342224]	Ø50 mm	
Tähtotsik TX20 [00340865]	6,3 mm (1/4 tolli)	

## 4.1 Uksetihendi vahetamine

Nõue:

- ✓ Uks on lahti.

### 4.1.1 Uksetihendi eemaldamine

1. Vabastage uksetihend soonest paremast ja vasakust nurgast.

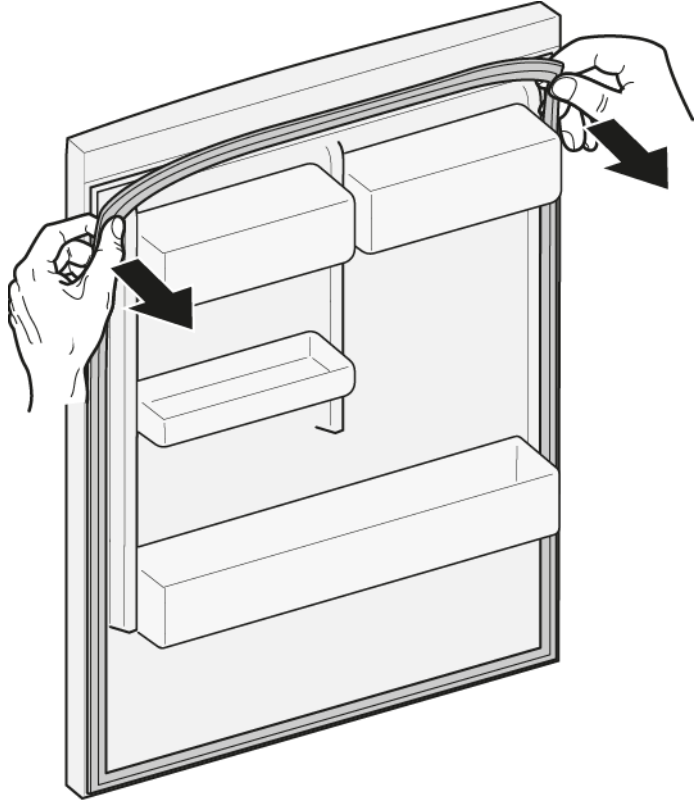

2. Tõmmake uksetihend soonest välja.



- ➡ Uksetihend on eemaldatud.

### 4.1.2 Uksetihendi paigaldamine





Uue uksetihendi paksus võib veidi erineda vana tihendi paksusest. See ei mõjuta ukse sulgemist ja pikaajalist tööd.

Kui teie seadmel on reguleeritavad hinged või hingekinnitused, saate sulgemismehhanismi hiljem sobivaks sättida.

Väikesed augud uksetihendis on vajalikud õhutuseks. Need ei ole tootmisvead.

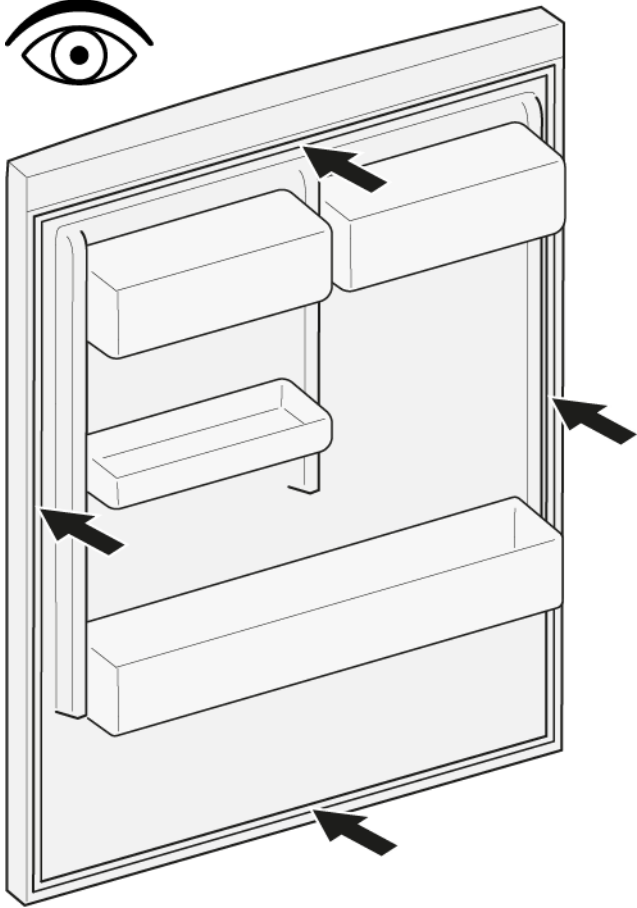
1. Kontrollige, kas tihendi soon on terve.



2.  Kui tihendi soon on kahjustatud,  
- pöörduge klienditeeninduse poole.

3.  Uksetihendi kerge kõverdumine on normaalne ega mõjuta selle toimivust. Soovitav on uksetihend enne seadmesse paigaldamist sirgu tõmmata.

Soojendage uksetihendit fööni või sooja veega ja vormige seda käsitsi.

4. Lükake tihendi otsad soone üla- ja alanurka.

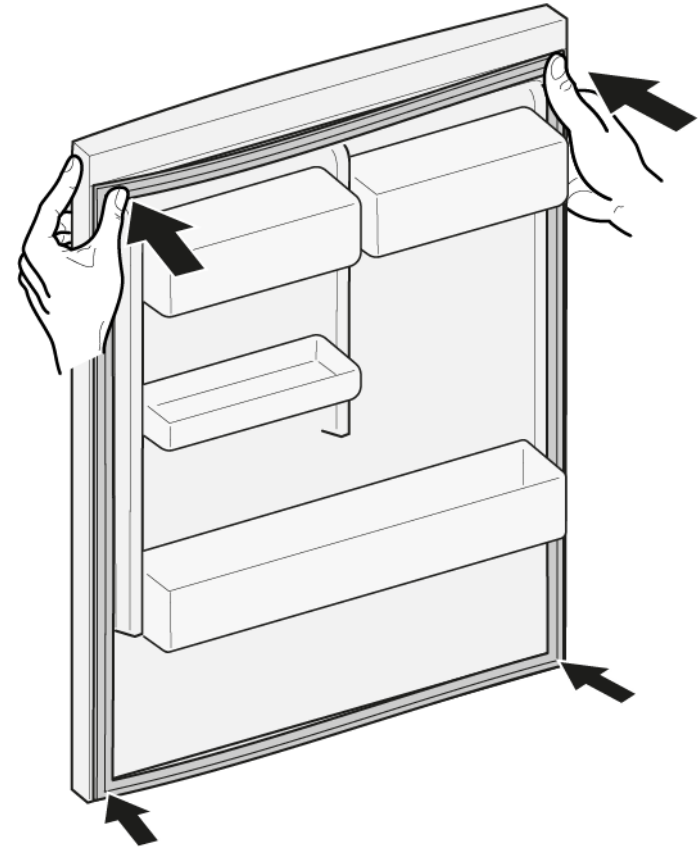

5. Vajutage terve tihend jupphaaval soonde.



➡ Uksetihend on paigaldatud.

## 4.2 Tasapinnalise hinge vahetamine

### Eritööriistad:

Tähtotsik TX20

6,3 mm (1/4 tolli)

[00340865]

	<p style="text-align: center;"><b>⚠ HOIATUS</b></p> <p><b>Masked, kogukad seadmed!</b> Selja- ja lihasevigastused</p> <ul style="list-style-type: none"> <li>▶ Seadme ust tohivad eemaldada vaid vastava väljaõppe saanud spetsialistid.</li> <li>▶ Seadme liigutamiseks on vaja kaht inimest.</li> <li>▶ Kasutage vaid sobivaid tööriistu ja varustust.</li> </ul>
	<p style="text-align: center;"><b>⚠ ETTEVAATUST!</b></p> <p><b>Teravad servad!</b> Lõikehaavad</p> <ul style="list-style-type: none"> <li>▶ Kandke kaitsekindaid.</li> </ul>
	<p style="text-align: center;"><b>⚠ ETTEVAATUST!</b></p> <p><b>Avatud liigendi piirkond!</b> Sõrmede muljumine/kinnijäämine</p> <ul style="list-style-type: none"> <li>▶ Ärge pistke käsi liigendi piirkonda.</li> <li>▶ Kandke kaitsekindaid.</li> </ul>
	<p style="text-align: center;"><b>⚠ ETTEVAATUST!</b></p> <p><b>Lahtikeeratud poltidest tingitud osade kukkumisoht!</b> Kukkuvatest osadest tingitud vigastused.</p> <ul style="list-style-type: none"> <li>▶ Kinnitage osa allakukkumise vastu.</li> </ul>
	<p style="text-align: center;"><b>TÄHELEPANU!</b></p> <p><b>Lahtikeeratud poltidest tingitud osade kukkumisoht!</b> Seadme teiste osade kahjustused või klientide vara kahjustused.</p> <ul style="list-style-type: none"> <li>▶ Kinnitage osa allakukkumise vastu.</li> </ul>

### Nõue:

- ✔ Seade on toitest lahutatud.
- ✔ Mööbliuks on eemaldatud. Vt paigaldusjuhiseid.
- ✔ Uks on lahti.

## 4.2.1 Tasapinnalise hinge eemaldamine

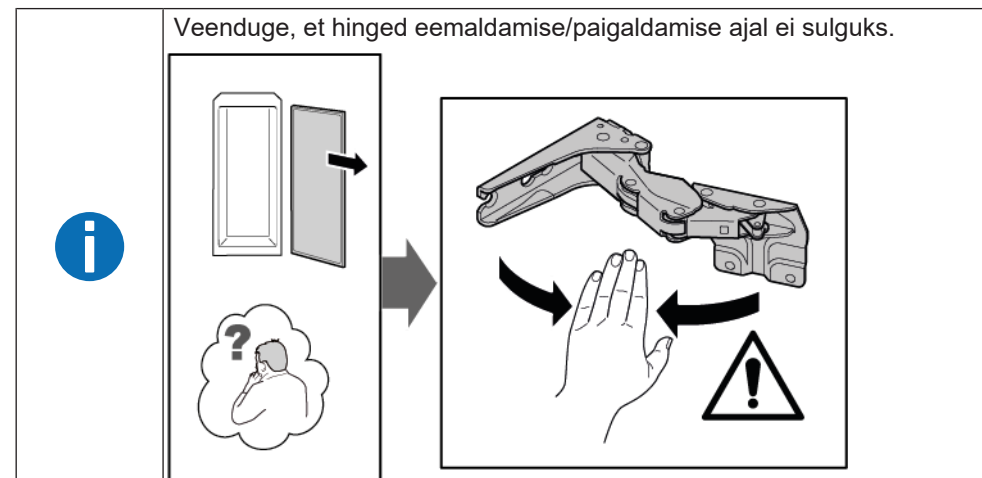

1. Eemaldage kaks hinge katet.

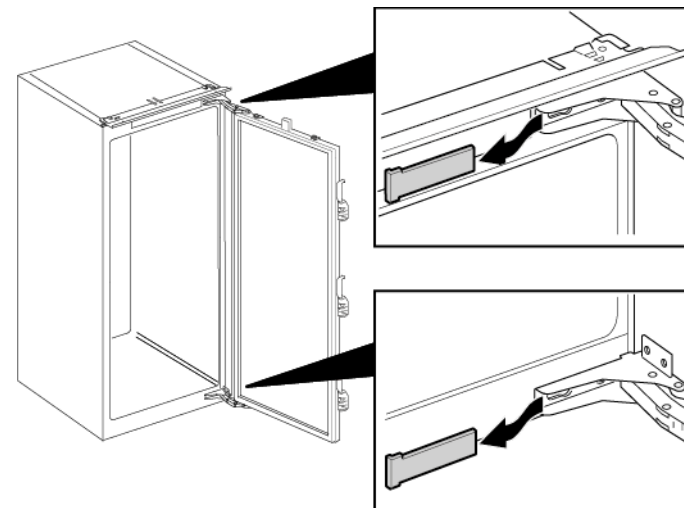

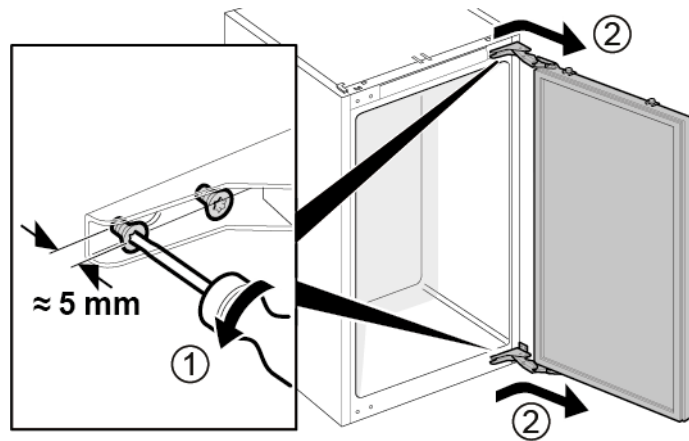

## Remont

2. 1. Keerake lahti neli kruvi (1).
2. Libistage uks välja ja eemaldage see (2).

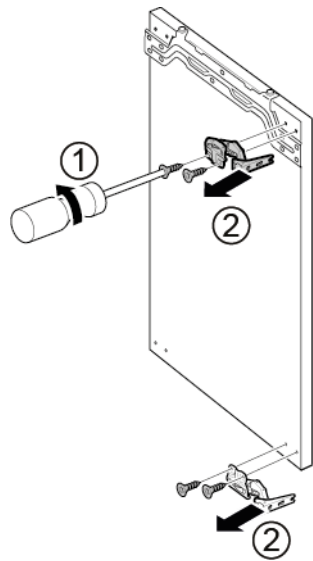

3. 1. Eemaldage neli kruvi (1).
2. Eemaldage hinged (2).



 Hinged on eemaldatud.

### 4.2.2 Tasapinnalise hinge paigaldamine

- ▶ Paigaldage vastupidises järjekorras.

## 4.3 Lükandhinge vahetamine

### Eritööriistad:

Tähtotsik TX20

6,3 mm (1/4 tolli)

[00340865]

	<p style="text-align: center;"><b>⚠ HOIATUS</b></p> <p><b>Rasked, kogukad seadmed!</b> Selja- ja lihasevigastused</p> <ul style="list-style-type: none"> <li>▶ Seadme ust tohivad eemaldada vaid vastava väljaõppe saanud spetsialistid.</li> <li>▶ Seadme liigutamiseks on vaja kaht inimest.</li> <li>▶ Kasutage vaid sobivaid tööriistu ja varustust.</li> </ul>
	<p style="text-align: center;"><b>⚠ ETTEVAATUST!</b></p> <p><b>Teravad servad!</b> Lõikehaavad</p> <ul style="list-style-type: none"> <li>▶ Kandke kaitsekindaid.</li> </ul>
	<p style="text-align: center;"><b>⚠ ETTEVAATUST!</b></p> <p><b>Lahtikeeratud poltidest tingitud osade kukkumisoht!</b> Kukkuvatest osadest tingitud vigastused.</p> <ul style="list-style-type: none"> <li>▶ Kinnitage osa allakukkumise vastu.</li> </ul>
	<p style="text-align: center;"><b>TÄHELEPANU!</b></p> <p><b>Lahtikeeratud poltidest tingitud osade kukkumisoht!</b> Seadme teiste osade kahjustused või klientide vara kahjustused.</p> <ul style="list-style-type: none"> <li>▶ Kinnitage osa allakukkumise vastu.</li> </ul>

### Nõue:

- ✔ Seade on toitest lahutatud.
- ✔ Mööbliuks ja seadme uks on eraldatud. Vt paigaldusjuhiseid.

### 4.3.1 Lükandhinge eemaldamine

- ▶ 1. Keerake lahti kaks kruvi (1).
- ▶ 2. Eemaldage ülemine hing (2).
- ▶ 3. Eemaldage uks (3).
- ▶ 4. Keerake lahti kaks kruvi (4).
- ▶ 5. Eemaldage alumine hing (5).

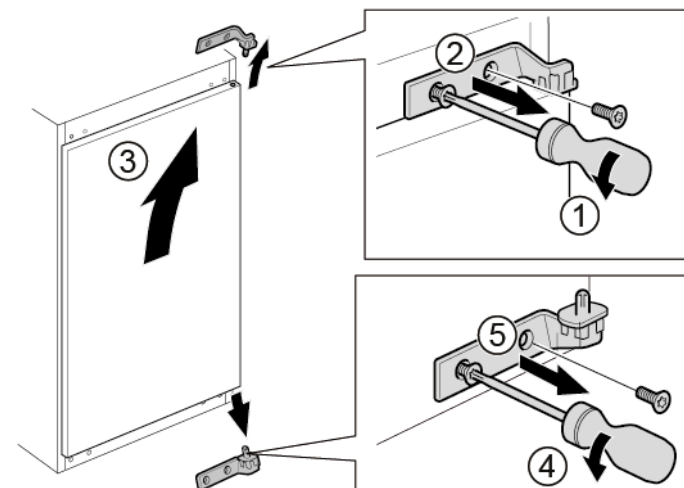

➡ Hinged on eemaldatud.

### 4.3.2 Lükandhinge paigaldamine

- ▶ Paigaldage vastupidises järjekorras.



## 4.4 Riiuli vahetamine

Nõue:

- ✓ Uks on lahti.

### 4.4.1 Riiuli eemaldamine

- ▶ Tõmmake riiul välja.



➡ Riiul on eemaldatud.

### 4.4.2 Riiuli paigaldamine

- ▶ Paigaldage vastupidises järjekorras.

## 4.5 Ukseraami vahetamine

Nõue:

- ✓ Uks on lahti.

### 4.5.1 Ukseraami eemaldamine

- ▶ Tõstke ukseraam üles.

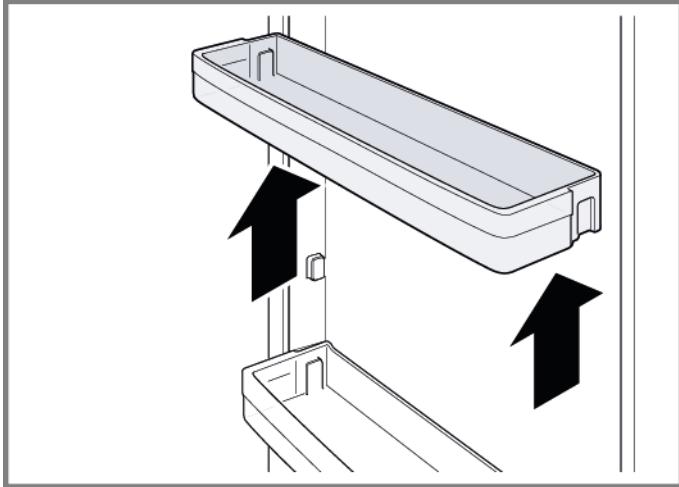

➡ Ukseraam on eemaldatud.

### 4.5.2 Ukseraami paigaldamine

- ▶ Paigaldage vastupidises järjekorras.

## 4.6 Puu- ja köögiviljamahuti vahetamine

Nõue:

- ✓ Uks on lahti.

### 4.6.1 Puu- ja köögiviljamahuti eemaldamine

1. Tõmmake puu- ja köögiviljade mahuti nii kaugele välja, kui see ulatub.
2. 1. Tõstke puu- ja köögiviljamahutit esiosast (1).  
2. Eemaldage mahuti (2).

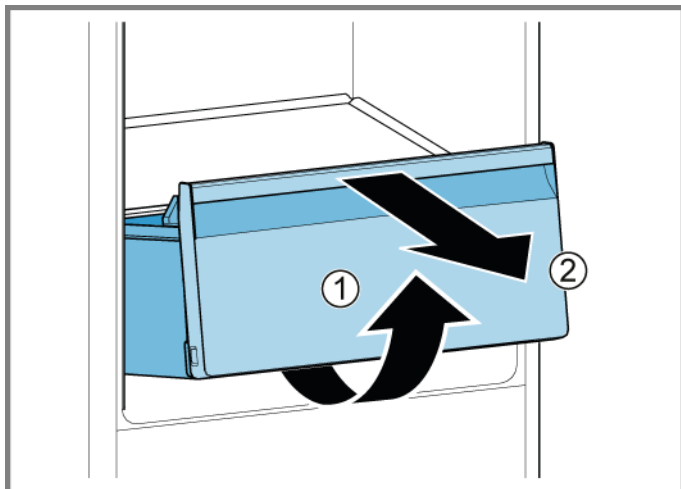

- ➔ Puu- ja köögiviljamahuti on eemaldatud.

### 4.6.2 Puu- ja köögiviljamahuti paigaldamine

- ▶ Paigaldage vastupidises järjekorras.

## 4.7 Külgmise LED-tule vahetamine

### Eritööriistad:

Iminapp Ø50 mm [00342224]

**i** Teie seadmel on LED-tuli, mis ei vaja hooldust.  
Seda tuld tohib parandada ainult klienditeenindus või volitatud tehnik!

**!** **OHT**  
**Liikuvatest osadest tingitud elektrilöögi oht!**  
Kui remonditööd on valesti tehtud, esineb elektrilöögist tingitud eluohu.  
▶ Elektrilisi osasid peavad parandama kvalifitseeritud elektrikud.  
▶ Pärast remonti peab olema tehtud ohutuskatse vastavalt standardile VDE 0701 või riiklikele määrustele.

**!** **OHT**  
**Liikuvatest osadest tingitud elektrilöögi oht!**  
Elektrilöögist tingitud surm  
▶ Enne remonditöödega alustamist ühendage seadmed elektrivõrgust lahti vähemalt 60 sekundit varem.

**!** **ETTEVAATUST!**  
**Teravad servad!**  
Lõikehaavad  
▶ Kandke kaitsekindaid.

### Nõue:

- ✓ Seade on toitest lahutatud.
- ✓ Uks on lahti.
- ✓ Riivid on eemaldatud.

### 4.7.1 Külgmise LED-tule eemaldamine

1. Kleepige kaks iminappa külgmise LED-tule katte külge.

2. Tõmmake iminappasid ühe keerava liigutusega ettepoole.

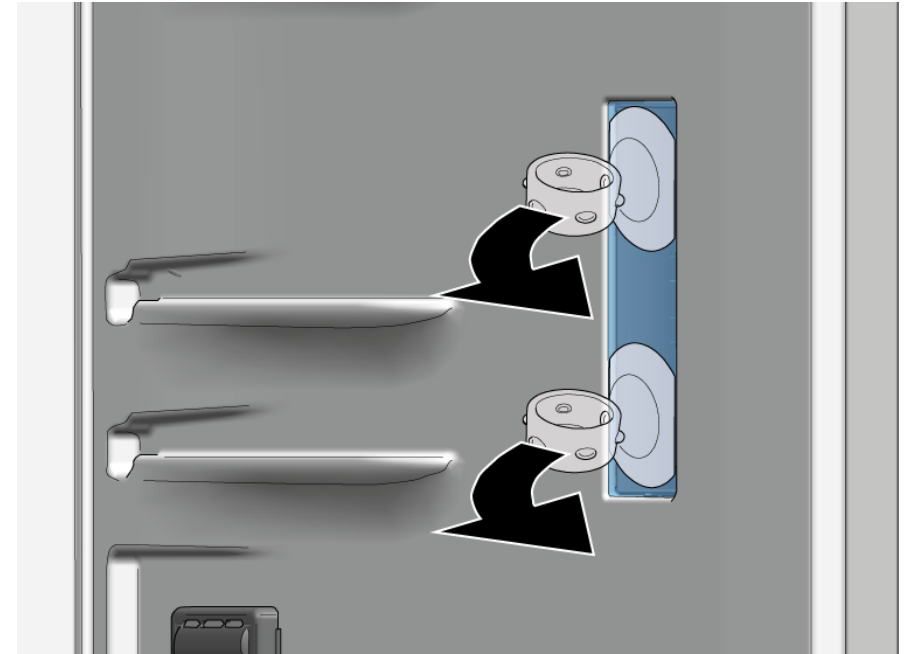

- ➡ LED-tule kate on eemaldatud.

## 3. Eemaldage LED-moodul.



➔ Külgmise LED-tuli on eemaldatud.





### 4.7.2 Külgmise LED-tule paigaldamine



Kuna elektripirni katte konksud võivad eemaldamise ajal hõlpsasti puruneda, sisaldab külgmise LED-tule varukomplekt LED-moodulit ja tule katet.

- ▶ Paigaldage vastupidises järjekorras.

# Korjausvinkit - Jääkaappi

 <b>Tämä asiakirja</b> .....	<b>115</b>
1.1 Tärkeitä tietoja.....	115
1.1.1 Tarkoitus .....	115
1.2 Symboleiden merkitys.....	115
1.2.1 Vaaratasot.....	115
1.2.2 Varoitusmerkit.....	115
1.2.3 Varoitusten rakenne .....	116
1.2.4 Yleiset symbolit.....	116
 <b>Turvallisuus</b> .....	<b>117</b>
2.1 Yleiset turvallisuusohjeet.....	117
2.1.1 Kaikki kotitalouskoneet.....	117
 <b>Työkalut ja apuvälineet</b> .....	<b>118</b>
 <b>Korjaus</b> .....	<b>119</b>
4.1 Oven tiivisteen vaihtaminen.....	119
4.1.1 Oven tiivisteen poistaminen .....	119
4.1.2 Oven tiivisteen asennus .....	119
4.2 Litteän saranan vaihtaminen .....	122
4.2.1 Litteän saranan poistaminen .....	122
4.2.2 Litteän saranan asennus .....	123
4.3 Liukusaranan vaihtaminen .....	124
4.3.1 Liukusaranan poistaminen .....	124
4.3.2 Liukusaranan asennus .....	124
4.4 Hyllyn vaihtaminen .....	125
4.4.1 Hyllyn poistaminen .....	125
4.4.2 Hyllyn asennus .....	125
4.5 Ovihyllyn vaihtaminen.....	126
4.5.1 Ovihyllyn poistaminen .....	126
4.5.2 Ovihyllyn asennus.....	126
4.6 Hedelmä- ja vihanneslokero vaihtaminen .....	127
4.6.1 Hedelmä- ja vihanneslokero poistaminen.....	127
4.6.2 Hedelmä- ja vihanneslokero asennus .....	127
4.7 LED-sivuvalon vaihtaminen .....	128
4.7.1 LED-sivuvalon poistaminen .....	128
4.7.2 LED-sivuvalon asennus.....	129

# Tämä asiakirja

## 1.1 Tärkeitä tietoja

### 1.1.1 Tarkoitus

Näiden korjausohjeiden tarkoituksena on auttaa kuluttajaa korjaamaan laitteita itse ekologista suunnittelua koskevan asetuksen (päivitys 03/2021) mukaisesti.



Ne sisältävät tietoja siitä, miten määrätyt varaosat voidaan vaihtaa. Lisäksi niihin sisältyy tietoja varoituksista ja riskeistä.

Ota yhteyttä huoltopalveluun, jos sinulla on kysyttävää. Vastamme vahingoista vain, jos korjausohjeita on noudatettu oikein.

## 1.2 Symboleiden merkitys

### 1.2.1 Vaaratasot

Varoitustasot koostuvat symbolista ja huomiosanasta. Huomiosanat ilmoittava vaaran vakavuuden.

Varoitustaso	Merkitys
 <b>VAARA</b>	Varoituksen laiminlyönti johtaa kuolemaan tai vakaviin loukkaantumisiin.
 <b>VAROITUS</b>	Varoituksen laiminlyönti voi johtaa kuolemaan tai vakaviin loukkaantumisiin.
 <b>HUOMAA</b>	Varoituksen laiminlyönti voi johtaa lieviin loukkaantumisiin.
<b>HUOMIO!</b>	Varoituksen laiminlyönti voi johtaa omaisuusvahinkoihin.

Taulukko 1: Vaaratasot

### 1.2.2 Varoitusmerkit

Varoitusmerkit ovat symboleita sisältäviä esityksiä, jotka osoittavat vaaran tyyppin.

Tässä asiakirjassa käytetään seuraavia varoitusmerkkejä:

Varoitusmerkki	Merkitys
	Yleinen varoitus
	Sähköjännitteestä aiheutuva vaara
	Räjähdysvaara
	Viiltohaavojen vaara
	Murskautumisen vaara

# Tämä asiakirja

Varoitusmerkki	Merkitys
	Kuumista pinnoista aiheutuva vaara
	Voimakkaasta magneettikentästä aiheutuva vaara
	Ionisoimattomasta säteilystä aiheutuva vaara



Taulukko 2: Varoitusmerkit

## 1.2.3 Varoitusten rakenne

Tämän asiakirjan sisältämällä varoituksilla on standardoitu ulkonäkö ja rakenne.



	<div style="background-color: red; color: white; padding: 2px; text-align: center;"> <b>VAARA</b></div> <p><b>Vaaran tyyppi ja lähde!</b> Vaaran/varoituksen laiminlyönnistä mahdollisesti aiheutuvat seuraukset.</p> <ul style="list-style-type: none"><li>▶ Vaaran ehkäisemiseen liittyvät toimenpiteet ja kiellot.</li></ul>
--	--

Seuraavassa esimerkissä näytetään varoitus, joka varoittaa jännitteisten osien aiheuttamasta sähköiskusta. Vaaran välttämiseksi suoritettava toimenpide mainitaan.

	<div style="background-color: red; color: white; padding: 2px; text-align: center;"> <b>VAARA</b></div> <p><b>Jännitteisten osien aiheuttama sähköiskun vaara!</b> Sähköiskun aiheuttama kuolema</p> <ul style="list-style-type: none"><li>▶ Erotta laitteet sähkövirrasta vähintään 60 sekuntia ennen korjaustöiden aloittamista.</li></ul>
---	---

## 1.2.4 Yleiset symbolit

Tässä asiakirjassa käytetään seuraavia yleisiä symboleja:

Yl. symboli	Merkitys
	Erikoisohjeen tunniste (teksti ja/tai kaavio)
	Yksinkertaisen ohjeen tunniste (vain teksti)

Yl. symboli	Merkitys
	Video-opetusohjelmaan johtavan linkin tunniste
	Tarvittavien työkalujen tunniste
	Tarvittavien edellytysten tunniste
	Ehdon (jos ..., sitten ...) tunniste
	Tuloksen tunniste
	Näppäimen tai painikkeen tunniste
	Materiaalinumeron tunniste
	Näytetyn tekstin/ikkunan (laitteen näytössä) tunniste

Taulukko 3: Yleiset symbolit



## 2.1 Yleiset turvallisuusohjeet

### 2.1.1 Kaikki kotitalouskoneet

#### Jännitteisten osien aiheuttama sähköiskun vaara!

- Virheet sähkökomponentteja sisältävissä korjauksissa voivat johtaa sähköiskuun!
- Kytke kone irti verkkovirrasta vähintään 60 sekuntia ennen töiden aloittamista.
- Pyydä korjauksen jälkeen suorittamaan VDE 0701 -säädöksen tai maakohtaisten säädösten mukainen turvallisuustesti.

#### Terävistä reunoista aiheutuva loukkaantumisvaara!

- Käytä suojakäsineitä.

#### Painavista ja liikkuvista komponenteista aiheutuva murskautumisen riski korjauksen, kunnossapidon, vianetsinnän ja huollon aikana

- Käytä suojakenkiä.
- Estä painavien komponenttien putoaminen.
- Älä koske liikkuviin komponentteihin.



#### Laitteen turvallisuudelle/toiminnalle aiheutuva riski!

- Käytä vain alkuperäisiä varaosia.

#### Staattiselle sähkölle herkkien komponenttien (ESDS) vaurioitumisen riski!

- Älä koske moduuleihin, liitännät ja johdinreitit mukaan luettuna.

## Työkalut ja apuvälineet

Nimitys	Yksityiskohdat	Kuvat
Suojapeite [00342013]	60 cm x 50 cm	
Imukuppi [00342224]	Ø50 mm	
Torx-kärki TX20 [00340865]	6,3 mm (1/4")	

## 4.1 Oven tiivisteiden vaihtaminen

### Vaatus:

- ✓ Ovi on auki.

### 4.1.1 Oven tiivisteiden poistaminen

1. Irrota oven tiiviste urasta oikeassa ja vasemmassa nurkassa.

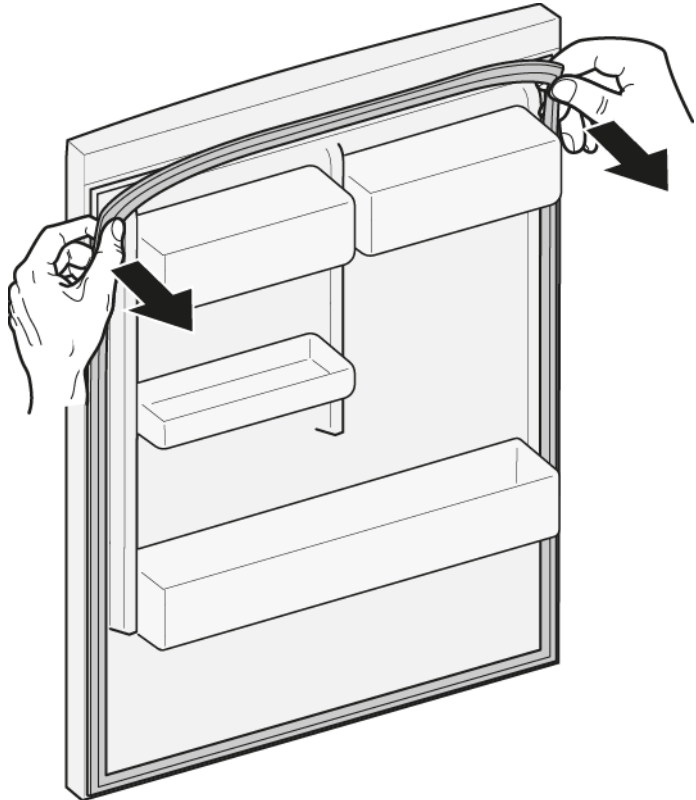

2. Vedä oven tiiviste ulos urasta.

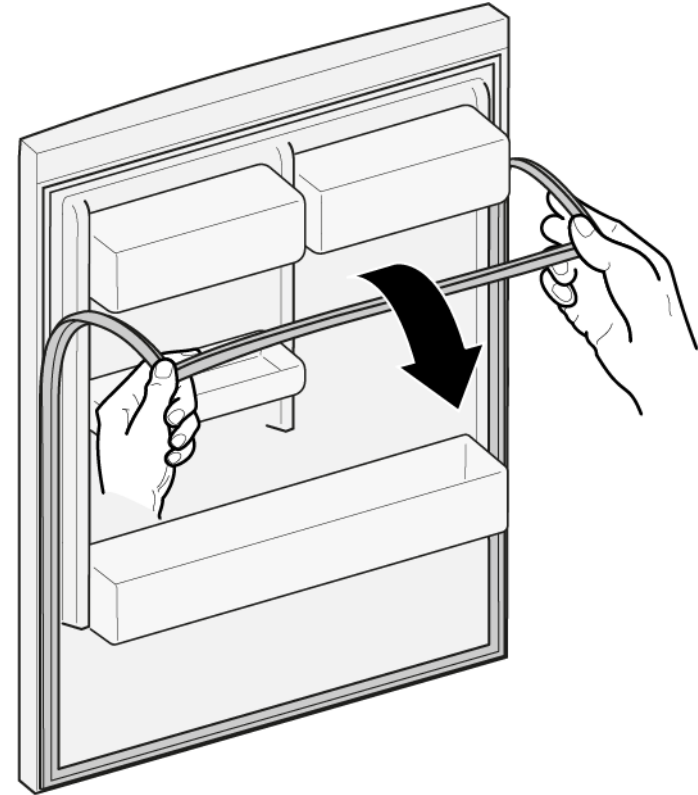

- ➡ Oven tiiviste on poistettu.

### 4.1.2 Oven tiivisteiden asennus





Uuden tiivisteiden paksuus voi poiketa hieman vanhan tiivisteiden paksuudesta. Sillä ei ole vaikutusta oven sulkeutumiseen eikä pitkän aikavälin toimintaan.

Jos laitteessa on säädettävät saranat tai saranan kiinnittimet, voit optimoida sulkeutumista myöhemmin.

Oven tiivisteiden sivuilla olevat pienet reiät ovat toiminnollisia (tarvitaan ilmanvaihtoa varten). Ne eivät ole tuotantovirheitä.

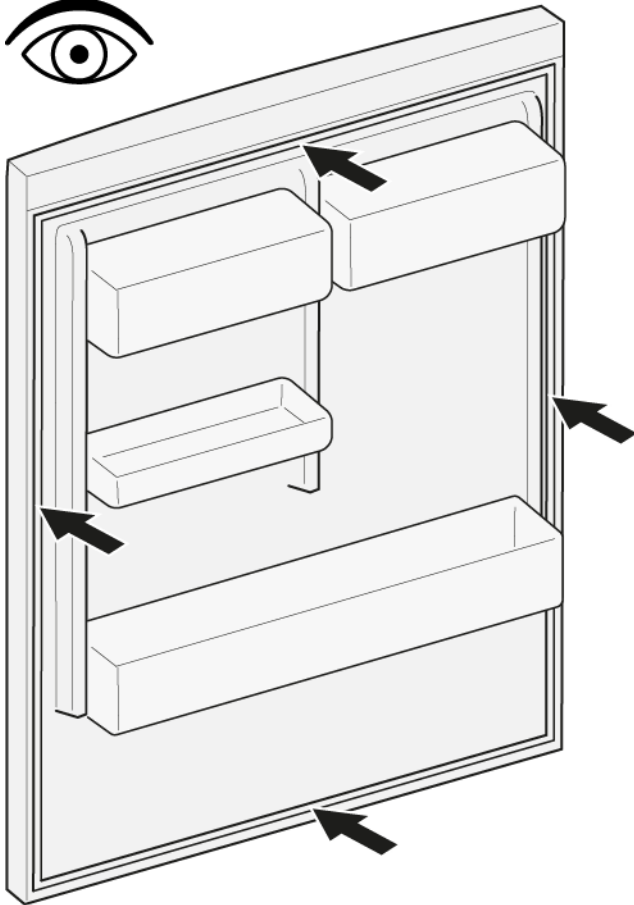
1. Tarkista, että tiivistettä varten oleva ura ei ole vioittunut.



2.  Jos tiivisteen ura on vioittunut.  
- Ota yhteyttä asiakaspalveluun.

3.  Oven tiivisteen pienet vääntymät ovat normaaleja eikä niillä ole vaikutusta sen toimintaan. Oven tiiviste kannattaa suoristaa, ennen kuin se asetetaan laitteeseen.

Kuumenna oven tiivistettä hiustenkuivaajalle tai kuumalla vedellä ja muotoile se käsin uudelleen.

4. Työnnä tiivisteen nurkat ylhäällä ja alhaalla uraan.

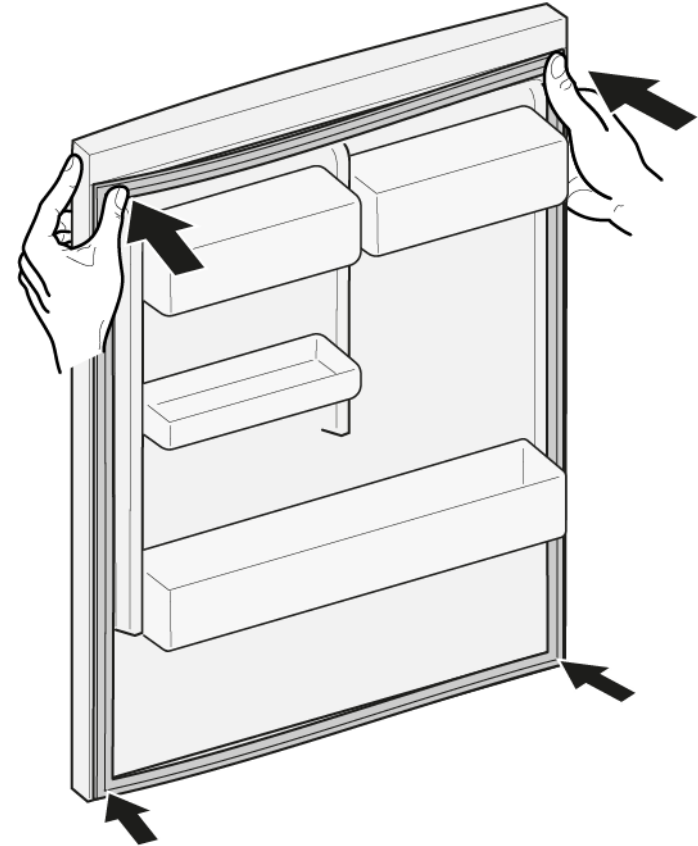

5. Paina koko tiiviste vähitellen uraan.



➡ Oven tiiviste on asennettu.

## 4.2 Litteän saranan vaihtaminen

### Erikoistyökalut:

Torx-kärki TX20

6,3 mm (1/4")

[00340865]

	<p style="text-align: center;"><b>VAROITUS</b></p> <p><b>Painavat, isokokoiset laitteet!</b> Selän ja lihasten vammat</p> <ul style="list-style-type: none"> <li>▶ Vain koulutettujen ammattilaisten tulisi suorittaa laitteen oven poistamiseen liittyvät vaiheet.</li> <li>▶ Laitteen siirtämiseen tarvitaan kahta ihmistä.</li> <li>▶ Käytä vain soveltuvia työkaluja ja välineitä.</li> </ul>
	<p style="text-align: center;"><b>HUOMAA</b></p> <p><b>Terävät reunat!</b> Viiltovammat</p> <ul style="list-style-type: none"> <li>▶ Käytä suojakäsineitä.</li> </ul>
	<p style="text-align: center;"><b>HUOMAA</b></p> <p><b>Avoin saranan alue!</b> Sormien murskautuminen / jääminen väliin</p> <ul style="list-style-type: none"> <li>▶ Älä koske saranan alueelle.</li> <li>▶ Käytä suojakäsineitä.</li> </ul>
	<p style="text-align: center;"><b>HUOMAA</b></p> <p><b>Ruuvien avaamisesta aiheutuva osien putoamisen riski!</b> Loukkaantuminen putoavien osien vuoksi.</p> <ul style="list-style-type: none"> <li>▶ Estä komponentin putoaminen.</li> </ul>
	<p style="text-align: center;"><b>HUOMIO!</b></p> <p><b>Ruuvien avaamisesta aiheutuva osien putoamisen riski!</b> Vauriot koneen muille osille tai asiakkaan kodille, esim. lattia.</p> <ul style="list-style-type: none"> <li>▶ Estä komponentin putoaminen.</li> </ul>

### Vaatus:

- ✓ Kone on erotettu teholahteesta.
- ✓ Kalusteovi on poistettu. Katso Asennusohjeet.
- ✓ Ovi on auki.

## 4.2.1 Litteän saranan poistaminen

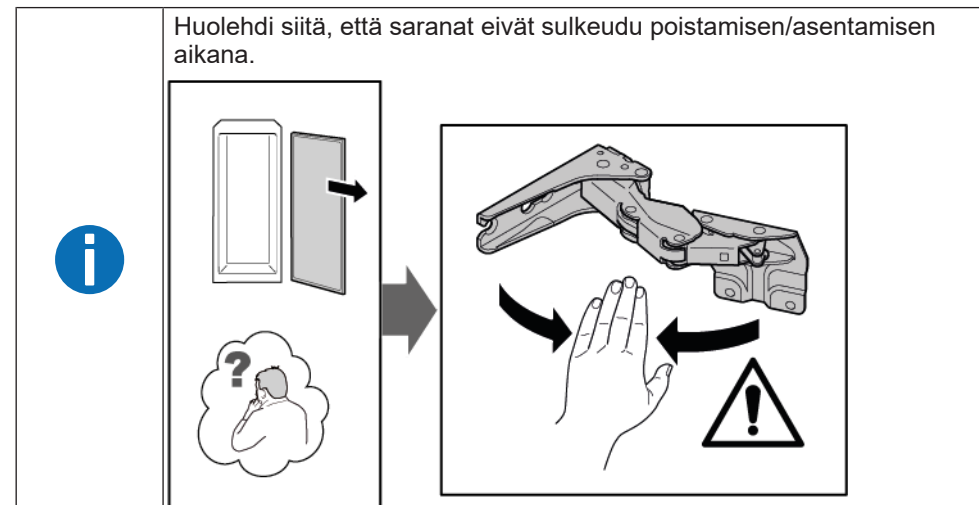

1. Poista kaksi saranan suojusta.

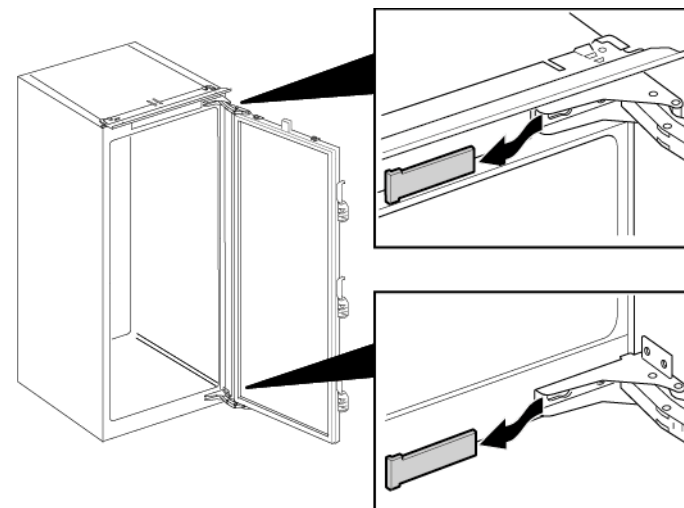



## Korjaus

2. 1. Löysää neljä ruuvia (1).
2. Liu'uta ovi ulos ja poista se (2).

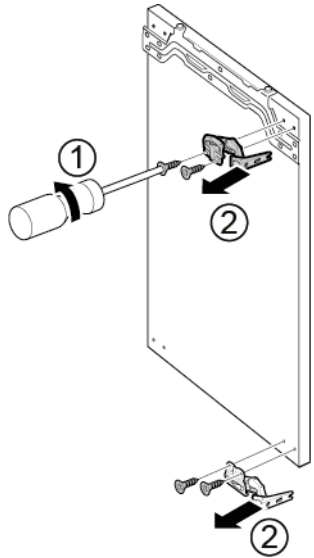

3. 1. Poista neljä ruuvia (1).
2. Poista saranat (2).



 Saranat on poistettu.





### 4.2.2 Litteän saranan asennus

- ▶ Asenna vastakkaisessa järjestyksessä.

## 4.3 Liukusaranan vaihtaminen

### Erikoistyökalut:

Torx-kärki TX20 6,3 mm (1/4") [00340865]

	<p style="text-align: center;"><b>VAROITUS</b></p> <p><b>Painavat, isokokoiset laitteet!</b> Selän ja lihasten vammat</p> <ul style="list-style-type: none"> <li>▶ Vain koulutettujen ammattilaisten tulisi suorittaa laitteen oven poistamiseen liittyvät vaiheet.</li> <li>▶ Laitteen siirtämiseen tarvitaan kahta ihmistä.</li> <li>▶ Käytä vain soveltuvia työkaluja ja välineitä.</li> </ul>
	<p style="text-align: center;"><b>HUOMAA</b></p> <p><b>Terävät reunat!</b> Viiltovammat</p> <ul style="list-style-type: none"> <li>▶ Käytä suojakäsineitä.</li> </ul>
	<p style="text-align: center;"><b>HUOMAA</b></p> <p><b>Ruuvien avaamisesta aiheutuva osien putoamisen riski!</b> Loukkaantuminen putoavien osien vuoksi.</p> <ul style="list-style-type: none"> <li>▶ Estä komponentin putoaminen.</li> </ul>
	<p style="text-align: center;"><b>HUOMIO!</b></p> <p><b>Ruuvien avaamisesta aiheutuva osien putoamisen riski!</b> Vauriot koneen muille osille tai asiakkaan kodille, esim. lattia.</p> <ul style="list-style-type: none"> <li>▶ Estä komponentin putoaminen.</li> </ul>

### Vaatus:

- ✔ Kone on erotettu teholahteesta.
- ✔ Kalusteovi ja laitteen ovi on erotettu toisistaan. Katso Asennusohjeet.

## 4.3.1 Liukusaranan poistaminen

- ▶ 1. Kierrä kaksi ruuvia auki (1).
- ▶ 2. Poista yläsarana (2).
- ▶ 3. Poista ovi (3).
- ▶ 4. Kierrä kaksi ruuvia auki (4).
- ▶ 5. Poista alasarana (5).

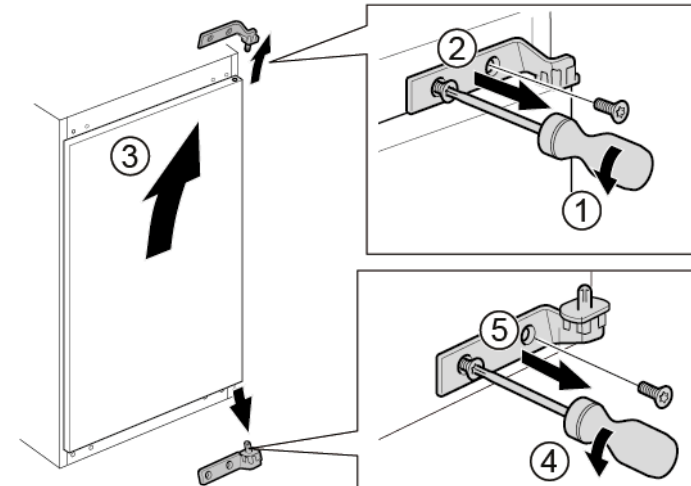

➡ Saranat on poistettu.

## 4.3.2 Liukusaranan asennus

- ▶ Asenna vastakkaisessa järjestyksessä.



## 4.4 Hyllyn vaihtaminen

### Vaatus:

- ✔ Ovi on auki.

### 4.4.1 Hyllyn poistaminen

- ▶ Vedä hylly ulos.



- ➡ Hylly on poistettu.

### 4.4.2 Hyllyn asennus

- ▶ Asenna vastakkaisessa järjestyksessä.

## 4.5 Ovihyllyn vaihtaminen

### Vaatus:

- ✔ Ovi on auki.

### 4.5.1 Ovihyllyn poistaminen

- ▶ Nosta ovihylly pois yläsuuntaan.

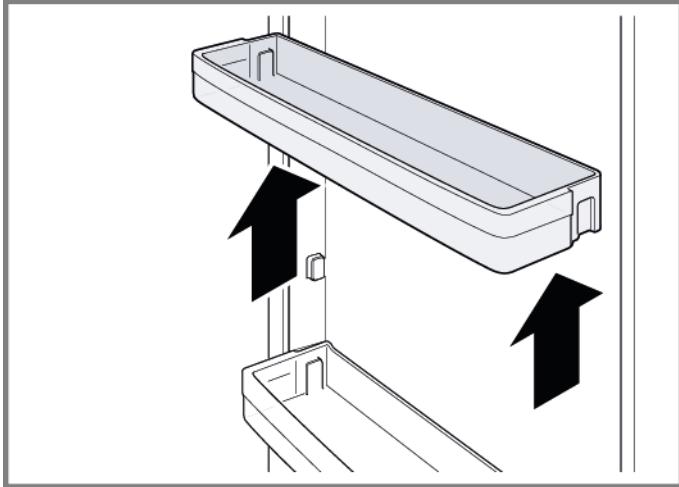

- ➡ Ovihylly on poistettu.

### 4.5.2 Ovihyllyn asennus

- ▶ Asenna vastakkaisessa järjestyksessä.

## 4.6 Hedelmä- ja vihanneslokeron vaihtaminen

### Vaatus:

- ✔ Ovi on auki.

### 4.6.1 Hedelmä- ja vihanneslokeron poistaminen

1. Vedä hedelmä- ja vihanneslokero niin ulos kuin se tulee.
2. 1. Nosta hedelmä- ja vihanneslokeroa edessä (1).  
2. Poista lokero (2).



- ➔ Hedelmä- ja vihanneslokero on poistettu.

### 4.6.2 Hedelmä- ja vihanneslokeron asennus

- ▶ Asenna vastakkaisessa järjestyksessä.

## 4.7 LED-sivuvalon vaihtaminen

### Erikoistyökalut:

Imukuppi Ø50 mm [00342224]

**i** Laite on varustettu huoltovapaalla LED-valolla.  
Vain huoltopalvelu tai valtuutetut teknikot saavat korjata nämä valot!

**⚠ VAARA**  
**Jännitteisten osien aiheuttama sähköiskun vaara!**  
Sähköiskusta aiheutuva hengenvaara väärän korjauksen tapauksessa

- ▶ Sähköosien korjaus tulisi antaa pätevien sähköasentajien suoritettavaksi.
- ▶ Pyydä korjauksen jälkeen suorittamaan VDE 0701 -säädöksen tai maakohtaisten säädösten mukainen turvallisuustesti.

**⚠ VAARA**  
**Jännitteisten osien aiheuttama sähköiskun vaara!**  
Sähköiskun aiheuttama kuolema

- ▶ Erotta laitteet sähkövirrasta vähintään 60 sekuntia ennen korjaustöiden aloittamista.

**⚠ HUOMAA**  
**Terävät reunat!**  
Viiltovammat

- ▶ Käytä suojakäsineitä.

### Vaatus:

- ✔ Kone on erotettu tehollähteestä.
- ✔ Ovi on auki.
- ✔ Hyllyt on poistettu.

### 4.7.1 LED-sivuvalon poistaminen

1. Kiinnitä kaksi imukuppia LED-sivuvalon suojukseen.

2. Vedä imukupit etusuuntaan yhdellä pyörittävällä liikkeellä.

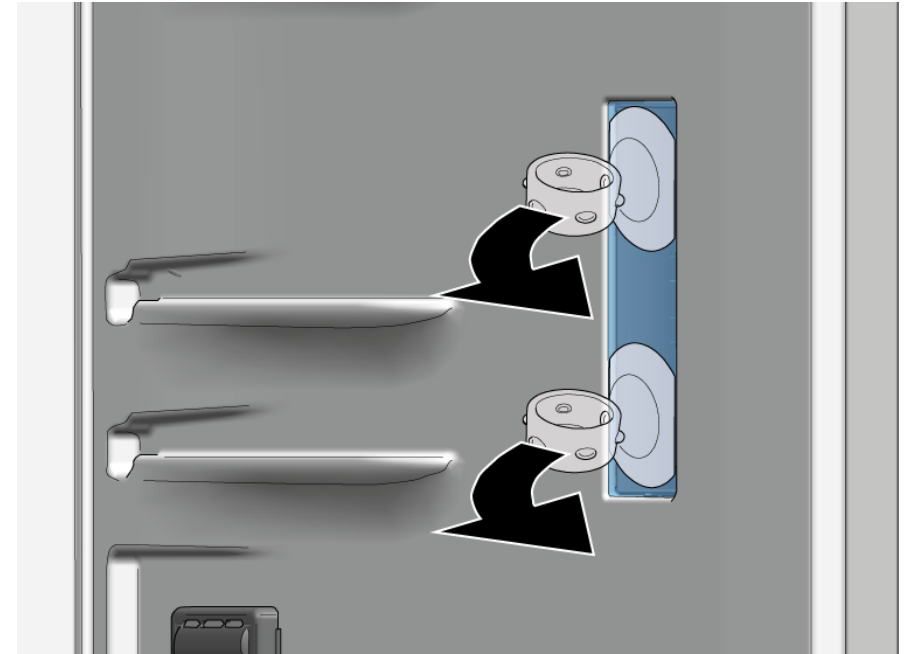

- ➡ LED-valon suojuus on poistettu.

## 3. Poista LED-moduuli.

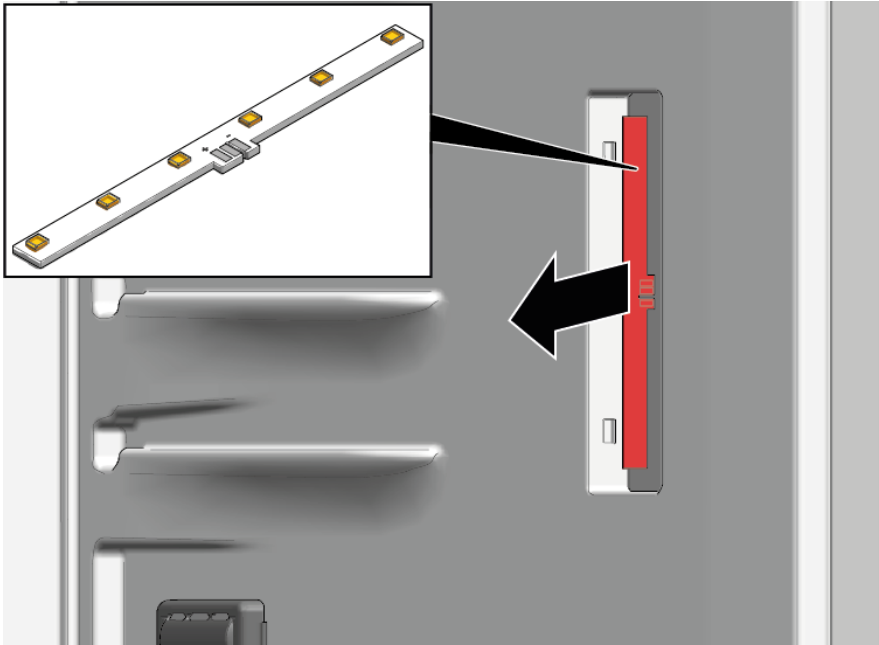

 LED-sivuvalo on poistettu.

### 4.7.2 LED-sivuvalon asennus



Lampun suojuksen takia kiinnittimet rikkoutuvat helposti poistamisen aikana. LED-sivuvalon varaosapaketti sisältää LED-moduulin ja lampun suojuksen.

- ▶ Asenna vastakkaisessa järjestyksessä.

# Conseils de réparation - Réfrigérateur

 <b>A propos de ce document.....</b>	<b>131</b>
1.1 Informations importantes.....	131
1.1.1 Objectif.....	131
1.2 Explication des symboles.....	131
1.2.1 Niveaux de risque.....	131
1.2.2 Symboles de danger.....	131
1.2.3 Structure des indications d'avertissement.....	132
1.2.4 Symboles généraux.....	132
 <b>Sécurité.....</b>	<b>133</b>
2.1 Consignes de sécurité générales.....	133
2.1.1 Tous les appareils électroménagers.....	133
 <b>Outils et aides.....</b>	<b>134</b>
 <b>Réparation.....</b>	<b>135</b>
4.1 Remplacer le joint de porte.....	135
4.1.1 Retirer le joint de porte.....	135
4.1.2 Monter le joint de porte.....	135
4.2 Remplacer la charnière plate.....	138
4.2.1 Retirer la charnière plate.....	138
4.2.2 Monter la charnière plate.....	139
4.3 Remplacer la charnière à glissière.....	140
4.3.1 Démontez la charnière à glissière.....	140
4.3.2 Monter la charnière à glissière.....	140
4.4 Remplacer la tablette.....	141
4.4.1 Retirer la tablette.....	141
4.4.2 Monter la tablette.....	141
4.5 Remplacer l'étagère de la porte.....	142
4.5.1 Retirer l'étagère de la porte.....	142
4.5.2 Monter l'étagère de la porte.....	142
4.6 Remplacer le bac de fruits et légumes.....	143
4.6.1 Retirer le bac de fruits et légumes.....	143
4.6.2 Monter le bac de fruits et légumes.....	143
4.7 Echange de l'éclairage LED latéral.....	144
4.7.1 Démontage de l'éclairage LED latéral.....	144
4.7.2 Montage de l'éclairage LED latéral.....	145

# **i** A propos de ce document

## 1.1 Informations importantes

### 1.1.1 Objectif

Les conseils de réparation qui suivent aident le consommateur à réparer l'appareil par lui-même, conformément au règlement sur l'écoconception (en vigueur en 03/2021).

Ils contiennent des informations sur l'échange de certaines pièces détachées, ainsi que des avertissements et risques.

Pour toute question, veuillez contacter notre service après-vente. Nous ne serons responsables des dommages que si les indications de réparation ont été suivies correctement.

## 1.2 Explication des symboles

### 1.2.1 Niveaux de risque

Les niveaux de risque se composent d'un symbole et d'un terme d'avertissement. Le mot d'avertissement caractérise la gravité du danger.









Niveau de dangerosité	Signification
 <b>DANGER</b>	Le non respect de la consigne d'avertissement provoque la mort ou des blessures graves.
 <b>AVERTISSEMENT</b>	Le non respect de la consigne d'avertissement peut provoquer la mort ou des blessures graves.
 <b>PRUDENCE</b>	Le non respect de la consigne d'avertissement peut provoquer des blessures légères.
 <b>ATTENTION !</b>	Le non respect de la consigne d'avertissement peut provoquer des dégâts matériels.

Tableau 1: Niveaux de risque

### 1.2.2 Symboles de danger

Les symboles de danger sont des représentations figuratives renseignant sur la nature du danger.

Ce document utilise les symboles de danger suivants:

Symbole de danger	Signification
	Consigne d'avertissement générale
	Danger engendré par la tension électrique
	Risque d'explosion
	Risque de blessures par coupure

## **i** A propos de ce document





Symbole de danger	Signification
	Risque de blessures par écrasement
	Danger engendré par des surfaces très chaudes
	Danger engendré par un champ magnétique puissant
	Danger engendré par un rayonnement non ionisant

Tableau 2: Symboles de danger

### 1.2.3 Structure des indications d'avertissement

Les consignes d'avertissement figurant dans ce document ont un aspect uniforme et une structure uniforme.

	<div style="background-color: red; color: white; padding: 2px; text-align: center;"><b>⚠ DANGER</b></div> <p><b>Type et source du danger !</b> Conséquences possibles en cas de non-respect du danger / de l'avertissement.</p> <ul style="list-style-type: none"> <li>▶ Mesures et interdictions pour éviter le danger.</li> </ul>
--	---

L'exemple suivant montre une consigne d'avertissement mettant en garde contre le risque d'électrocution. La mesure permettant d'éviter le danger est nommée.

	<div style="background-color: red; color: white; padding: 2px; text-align: center;"><b>⚠ DANGER</b></div> <p><b>Risque d'électrocution par des pièces conductrices de tension !</b> Mort par électrocution.</p> <ul style="list-style-type: none"> <li>▶ Débrancher l'appareil du secteur minimum 60 secondes avant de démarrer la réparation.</li> </ul>
--	---

### 1.2.4 Symboles généraux

Ce document utilise les symboles généraux suivants:











Symbole général	Signification
	Caractérisation d'une astuce particulière (texte et/ou graphique)
	Caractérisation d'une astuce simple (texte seul)
	Caractérisation d'un lien vers une vidéo
	Caractérisation d'outils nécessaires
	Caractérisation de conditions nécessaires
	Caractérisation d'une condition (si... , alors ...)
	Caractérisation d'un résultat
	Caractérisation d'une touche ou surface de commande
	Caractérisation d'une référence de pièce
	Caractérisation d'un texte affiché / fenêtre (sur l'afficheur)

Tableau 3: Symboles généraux



## 2.1 Consignes de sécurité générales

### 2.1.1 Tous les appareils électroménagers

#### **Risque d'électrocution en raison de pièces sous tension!**

- Des erreurs lors de réparations impliquant des composants électriques peuvent entraîner une décharge électrique!
- Débrancher l'appareil du secteur minimum 60 secondes avant de démarrer la réparation.
- Après la réparation, effectuer un test de sécurité selon VDE 0701 ou les réglementations spécifiques nationales.

#### **Risque de blessures par coupure sur des bords tranchants!**

- Porter des gants de protection.

#### **Risque de casse durant la réparation, maintenance, dépannage et SAV en raison de composants lourds et mobiles**

- Porter des chaussures de protection.
- Sécuriser les composants lourds contre le risque de chute.
- Ne pas coller les pièces du châssis sur les composants mobiles.



#### **Risque lié à la sécurité / fonction de l'appareil!**

- Utiliser uniquement des pièces détachées d'origine.

#### **Risque d'endommagement des composants sensibles aux décharges électrostatiques!**

- Ne pas toucher les modules, ni leur connexions et pistes conductrices.

## Outils et aides

Désignation	Détails	Images
Tissu de protection [00342013]	60 cm x 50 cm	
Ventouse [00342224]	Ø50 mm	
Embout Torx TX20 [00340865]	6,3 mm (1/4")	

## 4.1 Remplacer le joint de porte

### Pré-requis:

- ✔ La porte est ouverte.

### 4.1.1 Retirer le joint de porte

1. Sortir le joint de porte de la rainure dans les coins gauche et droit.



2. Retirer le joint de porte de la rainure.



- ➡ Le joint de porte est retiré.

### 4.1.2 Monter le joint de porte



L'épaisseur du nouveau joint de porte peut différer légèrement de celle de l'ancien. Cela n'affectera en rien la fermeture ou le fonctionnement à long terme de la porte.

Si votre appareil est doté de charnière ou d'attaches de charnières ajustables, vous pourrez optimiser le comportement de fermeture par la suite. Les petits trous latéraux dans les joints de porte sont fonctionnels (nécessaires pour la ventilation). Il ne s'agit pas de défauts de production.

## Réparation

1. S'assurer de l'absence de dégâts dans les rainures qui doivent accueillir le joint.



4. Pousser les coins du joint en haut et en bas dans la rainure.

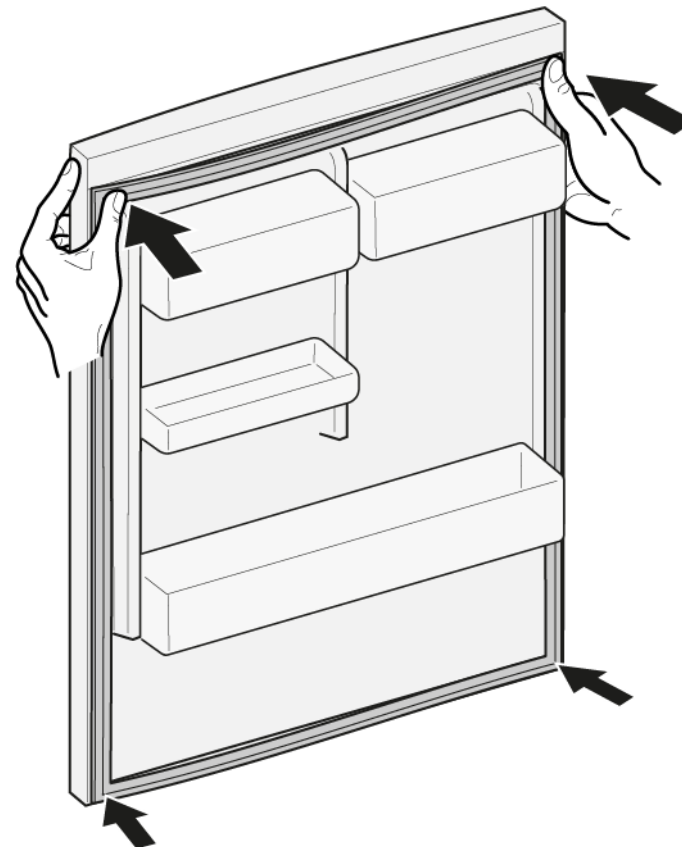

2.  Si la rainure de joint est endommagée.  
- Contacter le service après-vente.

3.  Une légère déformation du joint est normale et ne saurait en affecter le fonctionnement. Il est recommandé de redresser le joint de porte avant de l'insérer dans l'appareil.

Réchauffer le joint de porte avec un sèche-cheveux ou de l'eau chaude et le reformer manuellement.

## Réparation

5. Enfoncer progressivement le joint dans la rainure.



-  Le joint de porte est installé.

## 4.2 Remplacer la charnière plate

### Outillage nécessaire:

🌀 Embout Torx TX20      6,3 mm (1/4")      [00340865]

	<b>⚠️ AVERTISSEMENT</b>
	<p><b>Appareils lourds et volumineux !</b> Blessures dorsales et musculaires</p> <ul style="list-style-type: none"> <li>▶ Seuls des spécialistes dûment formés devraient retirer la porte de l'appareil.</li> <li>▶ Pour déplacer l'appareil, deux personnes sont nécessaires.</li> <li>▶ Utiliser seulement des outils et de l'équipement appropriés.</li> </ul>

	<b>⚠️ PRUDENCE</b>
	<p><b>Arêtes vives !</b> Blessures par coupure</p> <ul style="list-style-type: none"> <li>▶ Porter des gants de protection.</li> </ul>

	<b>⚠️ PRUDENCE</b>
	<p><b>Ouvrir la zone de charnière !</b> Écrasement/coincement des doigts</p> <ul style="list-style-type: none"> <li>▶ Ne pas insérer les doigts dans la zone de la charnière.</li> <li>▶ Porter des gants de protection.</li> </ul>

	<b>⚠️ PRUDENCE</b>
	<p><b>Risque de pièces qui chutent en raison de vis trop lâches !</b> Blessures dues à des pièces qui chutent.</p> <ul style="list-style-type: none"> <li>▶ Sécuriser les composants contre le risque de chute.</li> </ul>

	<b>⚠️ ATTENTION !</b>
	<p><b>Risque de pièces qui chutent en raison de vis trop lâches !</b> Dommages à d'autres parties de l'appareil ou à la propriété du client, p. ex. au plancher.</p> <ul style="list-style-type: none"> <li>▶ Sécuriser les composants contre le risque de chute.</li> </ul>

### Pré-requis:

- ✅ Appareil est déconnecté de l'alimentation.
- ✅ La porte du meuble est retirée. Voir les instructions de montage.
- ✅ La porte est ouverte.

### 4.2.1 Retirer la charnière plate

Veiller à ce que les charnières ne se ferment pas durant le retrait/le montage.

1. Retirer deux caches de charnière.

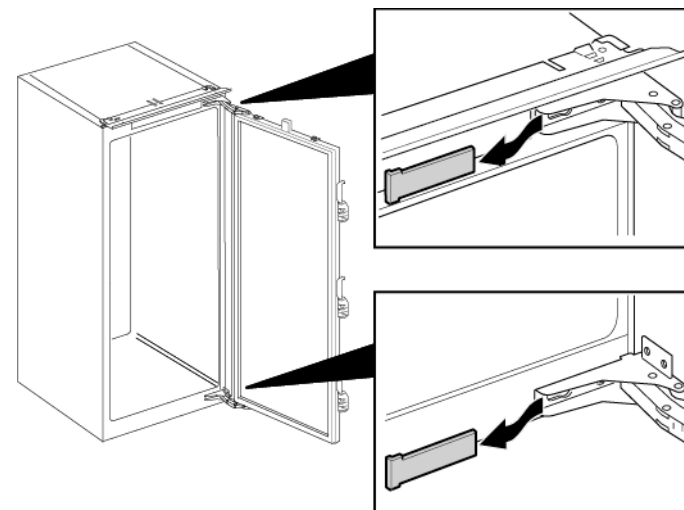

## Réparation

2. 1. Desserrer quatre vis (1).
2. Faire glisser la porte pour l'extraire (2).



3. 1. Retirer quatre vis (1).
2. Retirer les charnières (2).

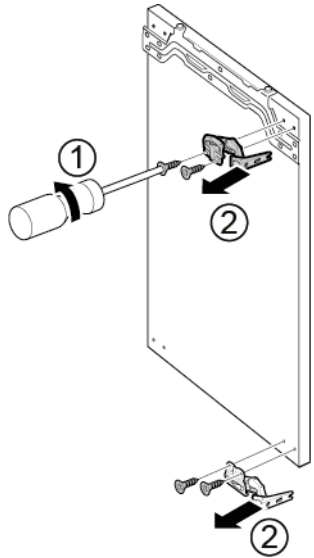

 Les charnières sont retirées.

### 4.2.2 Monter la charnière plate

- ▶ Le montage s'effectue dans l'ordre chronologique inverse.

## 4.3 Remplacer la charnière à glissière

### Outillage nécessaire:

🌀 Embout Torx TX20      6,3 mm (1/4")      [00340865]

	<b>⚠️ AVERTISSEMENT</b>
	<p><b>Appareils lourds et volumineux !</b> Blessures dorsales et musculaires</p> <ul style="list-style-type: none"> <li>▶ Seuls des spécialistes dûment formés devraient retirer la porte de l'appareil.</li> <li>▶ Pour déplacer l'appareil, deux personnes sont nécessaires.</li> <li>▶ Utiliser seulement des outils et de l'équipement appropriés.</li> </ul>

	<b>⚠️ PRUDENCE</b>
	<p><b>Arêtes vives !</b> Blessures par coupure</p> <ul style="list-style-type: none"> <li>▶ Porter des gants de protection.</li> </ul>

	<b>⚠️ PRUDENCE</b>
	<p><b>Risque de pièces qui chutent en raison de vis trop lâches !</b> Blessures dues à des pièces qui chutent.</p> <ul style="list-style-type: none"> <li>▶ Sécuriser les composants contre le risque de chute.</li> </ul>

	<b>ATTENTION !</b>
	<p><b>Risque de pièces qui chutent en raison de vis trop lâches !</b> Dommages à d'autres parties de l'appareil ou à la propriété du client, p. ex. au plancher.</p> <ul style="list-style-type: none"> <li>▶ Sécuriser les composants contre le risque de chute.</li> </ul>

### Pré-requis:

- ✔️ Appareil est déconnecté de l'alimentation.
- ✔️ La porte du meuble et la porte de l'appareil sont séparées. Voir les instructions de montage.

### 4.3.1 Démontez la charnière à glissière

- ▶ 1. Dévisser deux vis (1).
- ▶ 2. Retirer la charnière supérieure (2).
- ▶ 3. Retirer la porte (3).
- ▶ 4. Dévisser deux vis (4).
- ▶ 5. Retirer la charnière inférieure (5).

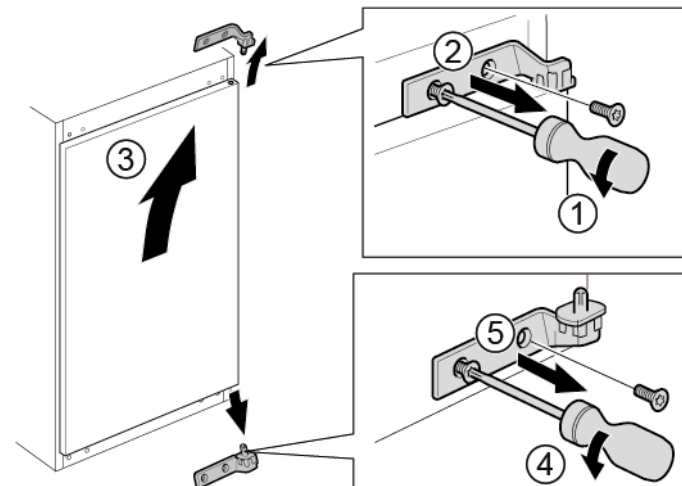

➡ Les charnières sont retirées.

### 4.3.2 Monter la charnière à glissière

- ▶ Le montage s'effectue dans l'ordre chronologique inverse.



## 4.4 Remplacer la tablette

### Pré-requis:

- ✔ La porte est ouverte.

### 4.4.1 Retirer la tablette

- ▶ Extraire la tablette.

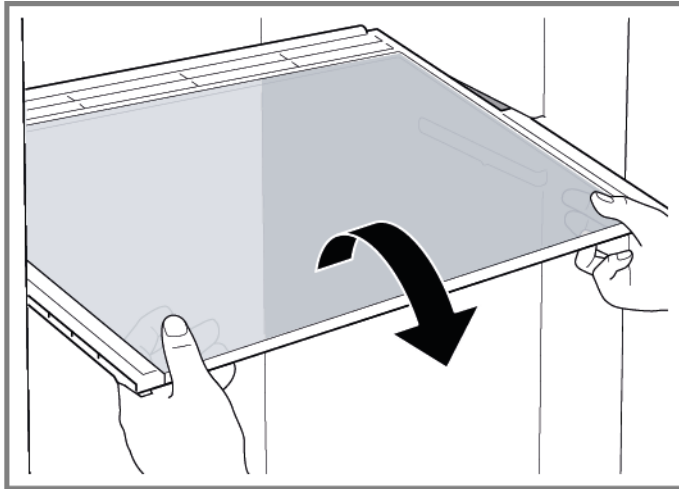

- ➡ La tablette est retirée.

### 4.4.2 Monter la tablette

- ▶ Le montage s'effectue dans l'ordre chronologique inverse.

## 4.5 Remplacer l'étagère de la porte

### Pré-requis:

- ✔ La porte est ouverte.

### 4.5.1 Retirer l'étagère de la porte

- ▶ Soulever l'étagère de la porte.



➡ L'étagère de la porte est retirée.

### 4.5.2 Monter l'étagère de la porte

- ▶ Le montage s'effectue dans l'ordre chronologique inverse.

## 4.6 Remplacer le bac de fruits et légumes

### Pré-requis:

- ✔ La porte est ouverte.

### 4.6.1 Retirer le bac de fruits et légumes

1. Extraire complètement le bac de stockage de fruits et légumes.
2. 1. Soulever le bac de fruits et légumes par l'avant (1).  
2. Retirer le bac (2).



- ➡ Le bac de fruits et légumes est retiré.

### 4.6.2 Monter le bac de fruits et légumes

- ▶ Le montage s'effectue dans l'ordre chronologique inverse.

## 4.7 Echange de l'éclairage LED latéral

### Outillage nécessaire:

🌀 Ventouse Ø50 mm [00342224]

	<p>Votre appareil est équipé d'un éclairage LED ne demandant pas d'entretien.</p> <p>Les réparations de cet éclairage sont exclusivement réservées au service après-vente ou à des spécialistes autorisés!</p>
---	--

	<p style="text-align: center;"><b>⚠ DANGER</b></p> <p><b>Risque d'électrocution en raison de pièces sous tension !</b> Risque d'électrocution en cas de réparation non conforme</p> <ul style="list-style-type: none"><li>▶ Les pièces électriques doivent être réparées par des techniciens qualifiés.</li><li>▶ Après la réparation, effectuer un test de sécurité selon VDE 0701 ou les réglementations spécifiques nationales.</li></ul>
--	--

	<p style="text-align: center;"><b>⚠ DANGER</b></p> <p><b>Risque d'électrocution par des pièces conductrices de tension !</b> Mort par électrocution.</p> <ul style="list-style-type: none"><li>▶ Débrancher l'appareil du secteur minimum 60 secondes avant de démarrer la réparation.</li></ul>
--	--

	<p style="text-align: center;"><b>⚠ PRUDENCE</b></p> <p><b>Arêtes vives !</b> Blessures par coupure</p> <ul style="list-style-type: none"><li>▶ Porter des gants de protection.</li></ul>
---	---

### Pré-requis:

- ✔ Appareil est déconnecté de l'alimentation.
- ✔ La porte est ouverte.
- ✔ Les clayettes sont retirées.

### 4.7.1 Démontage de l'éclairage LED latéral

1. Poser deux ventouses au niveau du cache de l'éclairage LED latéral.

2. Tirer les ventouses vers l'avant par un mouvement rotatif.

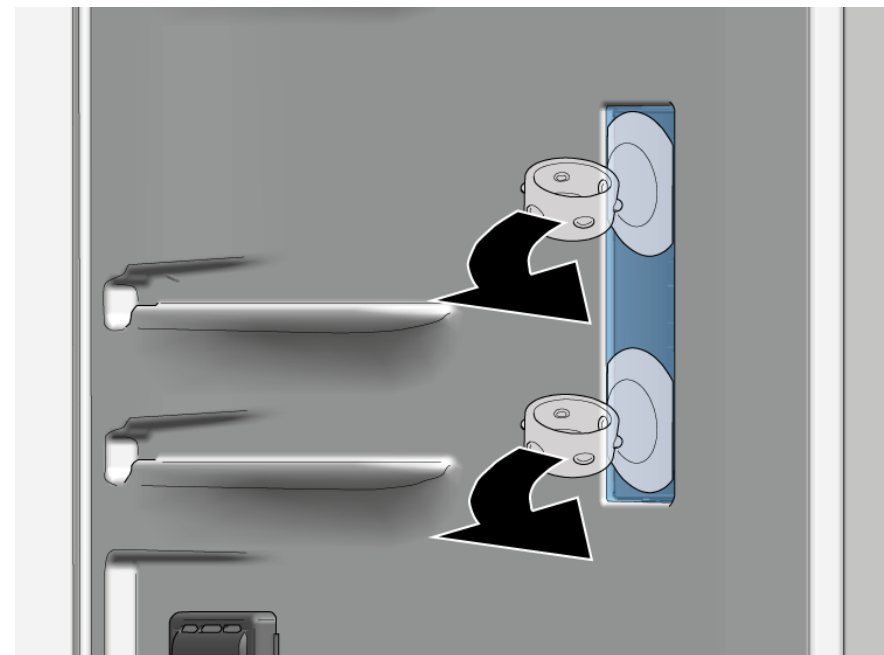

➡ Le cache de l'éclairage LED est retiré.

3. Retirer le module LED.



 L'éclairage LED latéral est retiré.





### 4.7.2 Montage de l'éclairage LED latéral



Comme les crochets du cache de l'éclairage latéral peuvent casser facilement lors du retrait, la pièce détachée comprend le module LED et le cache de l'éclairage.

► Le montage s'effectue dans l'ordre chronologique inverse.

# Reparatur Hinweise - Kühlschrank

 <b>Zu diesem Dokument</b> .....	<b>147</b>
1.1 Wichtige Hinweise: .....	147
1.1.1 Zweck .....	147
1.2 Zeichenerklärung.....	147
1.2.1 Gefahrenstufen .....	147
1.2.2 Gefahrensymbole.....	147
1.2.3 Struktur der Warnhinweise.....	148
1.2.4 Allgemeine Symbole .....	148
 <b>Sicherheit</b> .....	<b>149</b>
2.1 Allgemeine Sicherheitshinweise .....	149
2.1.1 Alle Hausgeräte .....	149
 <b>Werkzeuge und Hilfsmittel</b> .....	<b>150</b>
 <b>Instandsetzen</b> .....	<b>151</b>
4.1 Austauschen der Türdichtung.....	151
4.1.1 Ausbauen der Türdichtung.....	151
4.1.2 Einbauen der Türdichtung .....	151
4.2 Austauschen des Flachscharniers .....	154
4.2.1 Ausbauen des Flachscharniers .....	154
4.2.2 Einbauen des Flachscharniers .....	155
4.3 Austauschen des Schleppscharniers .....	156
4.3.1 Ausbauen des Schleppscharniers .....	156
4.3.2 Einbauen des Schleppscharniers .....	156
4.4 Austauschen der Ablage .....	157
4.4.1 Ausbauen der Ablage.....	157
4.4.2 Einbauen der Ablage.....	157
4.5 Austauschen des Türabstellers.....	158
4.5.1 Ausbauen des Türabstellers .....	158
4.5.2 Einbauen des Türabstellers .....	158
4.6 Austauschen des Obst- und Gemüsebehälters.....	159
4.6.1 Ausbauen des Obst- und Gemüsebehälters.....	159
4.6.2 Einbauen des Obst- und Gemüsebehälters.....	159
4.7 Austauschen der seitlichen LED-Beleuchtung .....	160
4.7.1 Ausbauen der seitlichen LED-Beleuchtung .....	160
4.7.2 Einbauen der seitlichen LED-Beleuchtung .....	161

# Zu diesem Dokument

## 1.1 Wichtige Hinweise:

### 1.1.1 Zweck

Diese Reparaturhinweise dienen zur Unterstützung des Kunden bei der selbständigen Gerätereparatur gemäß der entsprechenden Ökodesign-Richtlinie (ab 03/2021).

Sie enthalten Informationen zum Austausch bestimmter Ersatzteile sowie Warn- und Gefahrenhinweise.

Bitte wenden Sie sich in Zweifelsfällen an unseren Kundendienst. Bei nicht ordnungsgemäßer Befolgung der Reparaturhinweise ist die Schadenshaftung ausgeschlossen.

## 1.2 Zeichenerklärung

### 1.2.1 Gefahrenstufen

Die Gefahrenstufen bestehen aus einem Symbol und einem Signalwort. Das Signalwort kennzeichnet die Schwere der Gefahr.









Gefahrenstufe	Bedeutung
	Nichtbeachtung des Warnhinweises führt zu Tod oder schweren Verletzungen.
	Nichtbeachtung des Warnhinweises kann zu Tod oder schweren Verletzungen führen.
	Nichtbeachtung des Warnhinweises kann zu leichten Verletzungen führen.
	Nichtbeachtung des Warnhinweises kann zu Sachschäden führen.

Tabelle 1: Gefahrenstufen

### 1.2.2 Gefahrensymbole

Gefahrensymbole sind sinnbildliche Darstellungen, die einen Hinweis auf die Art der Gefahr geben.

In diesem Dokument werden folgende Gefahrensymbole verwendet:

Gefahrensymbol	Bedeutung
	Allgemeiner Warnhinweis
	Gefahr durch elektrische Spannung
	Gefahr durch Explosion
	Gefahr von Schnittverletzungen
	Gefahr von Quetschverletzungen

## **i** Zu diesem Dokument





Gefahrensymbol	Bedeutung
	Gefahr durch heiße Oberflächen
	Gefahr durch starkes Magnetfeld
	Gefahr durch nicht ionisierende Strahlung

Tabelle 2: Gefahrensymbole

### 1.2.3 Struktur der Warnhinweise

Warnhinweise haben in diesem Dokument ein einheitliches Aussehen und eine einheitliche Struktur.



	<div style="background-color: red; color: white; padding: 2px; text-align: center;"><b>⚠ GEFAHR</b></div> <p><b>Art und Quelle der Gefahr!</b> Mögliche Folgen bei Nichtbeachtung der Gefahr / des Warnhinweises.</p> <ul style="list-style-type: none"> <li>▶ Maßnahmen und Verbote zur Vermeidung der Gefahr.</li> </ul>
--	--

Das folgende Beispiel zeigt einen Warnhinweis, der vor Stromschlaggefahr durch spannungsführende Teile warnt. Die Maßnahme zur Vermeidung der Gefahr wird genannt.

	<div style="background-color: red; color: white; padding: 2px; text-align: center;"><b>⚠ GEFAHR</b></div> <p><b>Stromschlaggefahr durch spannungsführende Teile!</b> Tod durch Stromschlag</p> <ul style="list-style-type: none"> <li>▶ Gerät mindestens 60 Sekunden vor Reparaturbeginn vom Netz trennen.</li> </ul>
--	---

### 1.2.4 Allgemeine Symbole

In diesem Dokument werden folgende allgemeine Symbole verwendet:

Allg. Symbol	Bedeutung
	Kennzeichnung eines besonderen (Text und/oder Grafik) Tipps
	Kennzeichnung eines einfachen (nur Text) Tipps

Allg. Symbol	Bedeutung
	Kennzeichnung eines Links zu einer Videoanleitung
	Kennzeichnung erforderlicher Werkzeuge
	Kennzeichnung erforderlicher Voraussetzungen
	Kennzeichnung einer Bedingung (Wenn ..., dann ...)
	Kennzeichnung eines Ergebnisses
[Start]	Kennzeichnung einer Taste oder Schaltfläche
[00123456]	Kennzeichnung einer Materialnummer
Status	Kennzeichnung eines angezeigten Textes / Fensters (im Gerätedisplay)

Tabelle 3: Allgemeine Symbole



## 2.1 Allgemeine Sicherheitshinweise

### 2.1.1 Alle Hausgeräte

#### **Stromschlaggefahr durch spannungsführende Teile!**

- Wenn elektrische Komponenten fehlerhaft repariert werden, besteht Stromschlaggefahr!
- Das Gerät mindestens 60 Sekunden vor Beginn der Arbeiten vom Netz trennen.
- Nach der Reparatur muss eine Sicherheitsprüfung nach VDE 0701 oder länderspezifischen Vorschriften durchgeführt werden.

#### **Verletzungsgefahr durch scharfe Kanten!**

- Schutzhandschuhe tragen.

#### **Quetschgefahr während Reparatur-, Wartungs-, Fehlersuche- und Servicearbeiten durch schwere sich bewegende Bauteile**

- Schutzhandschuhe tragen.
- Schwere Bauteile gegen Herabfallen sichern.
- Körperteile nicht in sich bewegende Bauteile stecken.



#### **Gefährdung der Gerätesicherheit/-funktion!**

- Ausschließlich Originalersatzteile verwenden.

#### **Gefahr der Beschädigung elektrostatisch gefährdeter Bauteile (elektrostatische Entladungen)!**

- Die Module, einschließlich ihrer Anschlüsse und Leiterbahnen, keinesfalls berühren.

## Werkzeuge und Hilfsmittel

Bezeichnung	Details	Bilder
Schutztuch [00342013]	60 cm x 50 cm	
Saugnapf [00342224]	Ø50 mm	
Torx-Bit TX20 [00340865]	6,3 mm (1/4")	

## 4.1 Austauschen der Türdichtung

### Voraussetzung:

- ✔ Die Tür ist offen.

### 4.1.1 Ausbauen der Türdichtung

1. Die Türdichtung aus der Kerbe in der rechten und linken Ecke lösen.

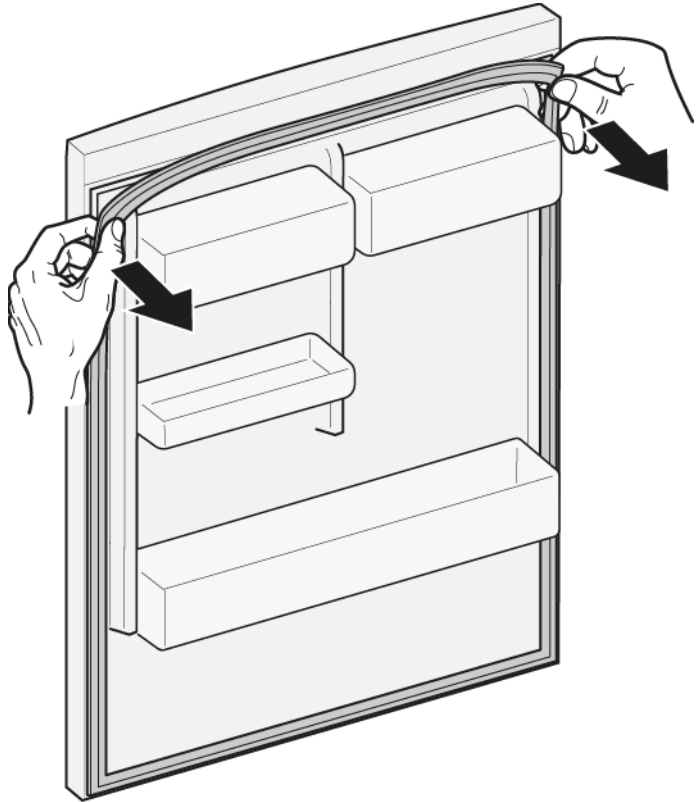

2. Die Türdichtung aus der Kerbe herausziehen.



- ➡ Die Türdichtung ist entfernt.

### 4.1.2 Einbauen der Türdichtung



Die Dicke neuer Türdichtungen kann geringfügig von der Dicke alter Türdichtungen abweichen. Dies hat auf das Schließverhalten und die langfristige Funktion keinen Einfluss.

Wenn das Gerät mit einstellbaren Scharnieren oder Scharnierbefestigungen ausgestattet ist, kann das Schließverhalten anschließend optimiert werden.

Die kleinen seitlichen Löcher in der Türdichtung haben eine wichtige Funktion (für Lüftung erforderlich). Es handelt sich hierbei nicht um Produktionsfehler.

## Instandsetzen

1. Die Dichtungskerbe auf Beschädigungen überprüfen.

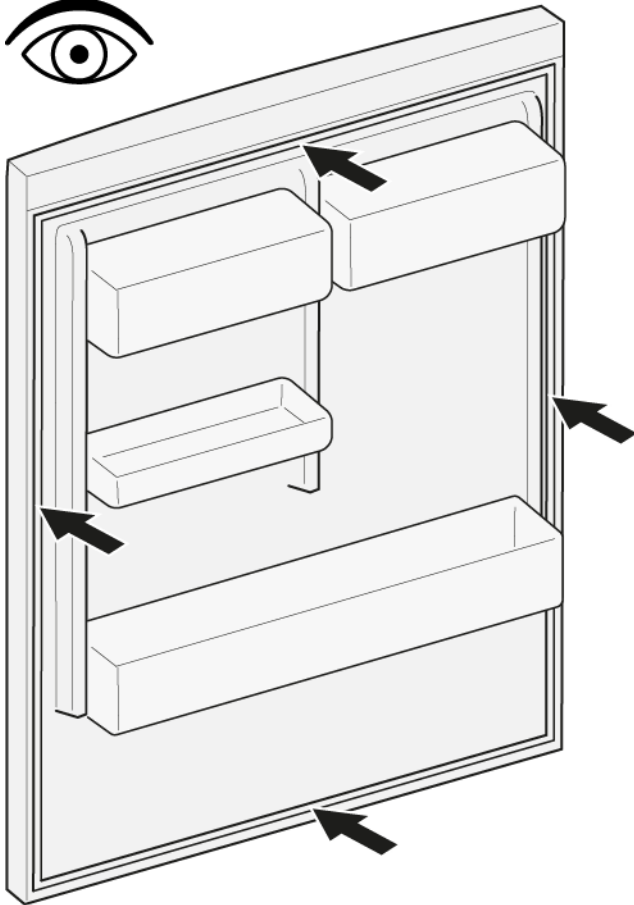

4. Die Dichtungsecken oben und unten in die Kerbe drücken.

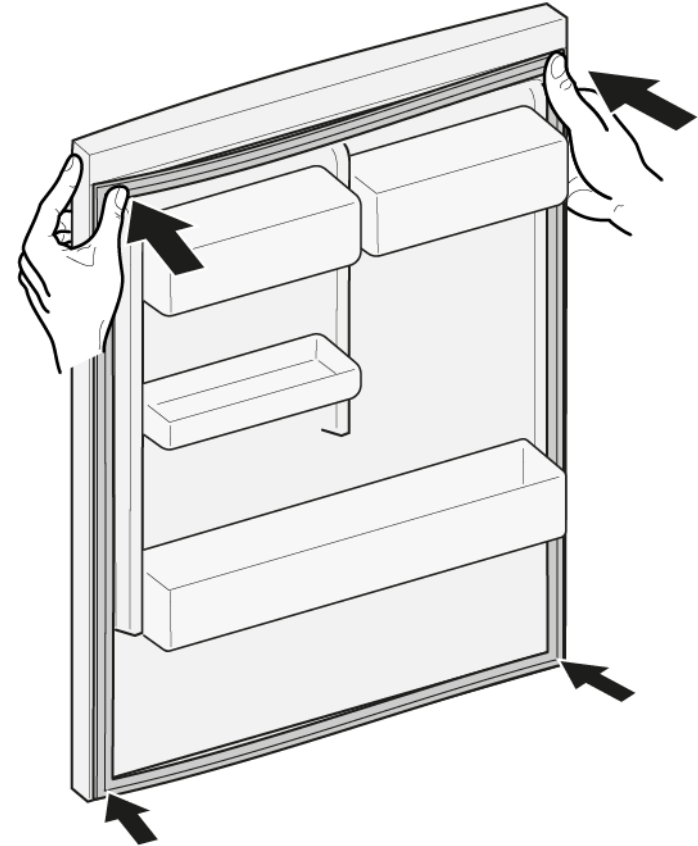

2.  Wenn die Dichtungskerbe beschädigt ist:
  - Den Kundendienst kontaktieren.

3.  Leichte Deformationen der Türdichtung sind normal und beeinträchtigen nicht die Funktion. Es wird empfohlen, die Türdichtung vor dem Einsetzen in das Gerät zu begradigen.

Die Türdichtung mit einem Haartrockner oder mit heißem Wasser erwärmen und von Hand in die richtige Form bringen.

## Instandsetzen

5. Die gesamte Dichtung Stück für Stück in die Kerbe drücken.





6. Die Türdichtung ist eingebaut.



## 4.2 Austauschen des Flachscharniers

### Spezielle Hilfsmittel:

 Torx-Bit TX20      6,3 mm (1/4")      [00340865]

	<p style="text-align: center;"><b>⚠️ WARNUNG</b></p> <p><b>Schwere, unhandliche Geräte!</b> Rücken- und Muskelverletzungen</p> <ul style="list-style-type: none"> <li>▶ Der Ausbau der Gerätetür sollte nur von geschulten Spezialisten durchgeführt werden.</li> <li>▶ Zum Bewegen des Geräts sind zwei Personen erforderlich.</li> <li>▶ Nur geeignete Werkzeuge und Vorrichtungen verwenden.</li> </ul>
	<p style="text-align: center;"><b>⚠️ VORSICHT</b></p> <p><b>Scharfe Kanten!</b> Schnittverletzungen</p> <ul style="list-style-type: none"> <li>▶ Schutzhandschuhe tragen.</li> </ul>
	<p style="text-align: center;"><b>⚠️ VORSICHT</b></p> <p><b>Offener Scharnierbereich!</b> Quetschen / Einklemmen der Finger</p> <ul style="list-style-type: none"> <li>▶ Nicht in den Scharnierbereich greifen.</li> <li>▶ Schutzhandschuhe tragen.</li> </ul>
	<p style="text-align: center;"><b>⚠️ VORSICHT</b></p> <p><b>Risiko herabfallender Teile durch gelöste Schrauben!</b> Verletzungsgefahr durch herabfallende Teile.</p> <ul style="list-style-type: none"> <li>▶ Die Komponenten gegen Herunterfallen sichern.</li> </ul>
	<p style="text-align: center;"><b>⚠️ ACHTUNG</b></p> <p><b>Risiko herabfallender Teile durch gelöste Schrauben!</b> Gefahr der Beschädigung anderer Geräteteile bzw. von Beschädigungen im Haushalt des Kunden, z. B. des Bodens.</p> <ul style="list-style-type: none"> <li>▶ Die Komponenten gegen Herunterfallen sichern.</li> </ul>

### Voraussetzung:

-  Das Gerät ist spannungsfrei.
-  Die Möbeltür ist entfernt. Siehe Installationsanleitung.
-  Die Tür ist offen.

## 4.2.1 Ausbauen des Flachscharniers

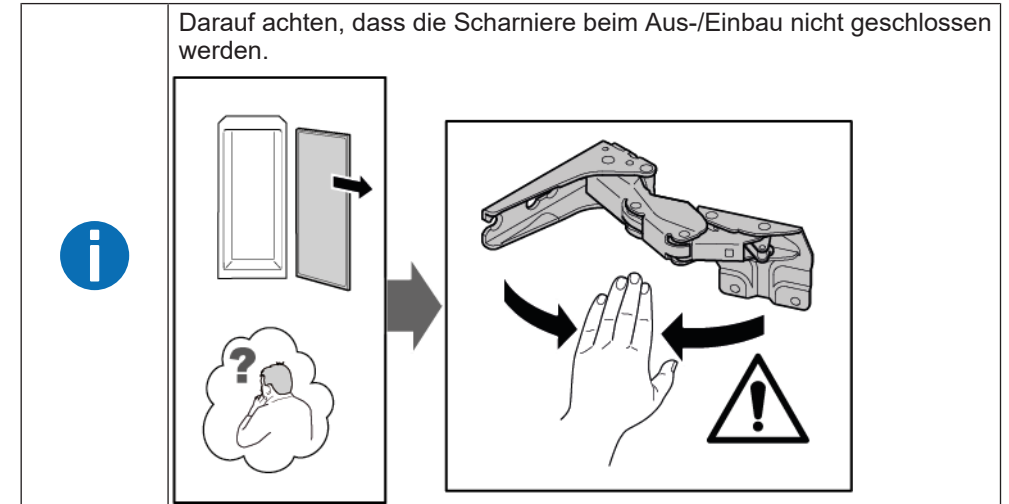

1. Die beiden Scharnierabdeckungen entfernen.

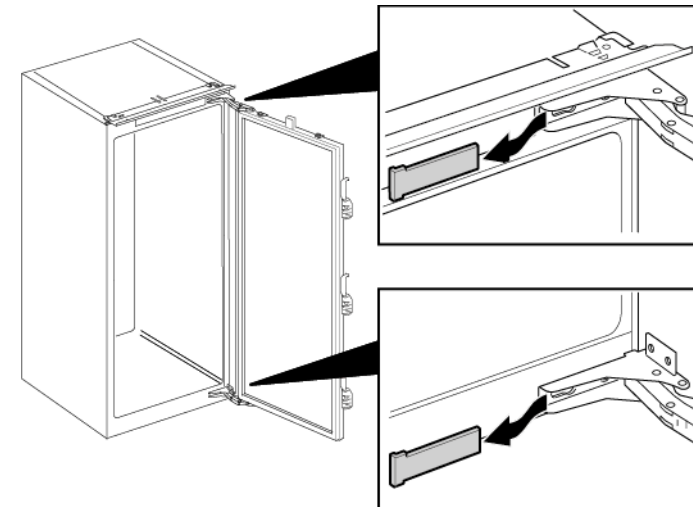

## Instandsetzen

2. 1. Die vier Schrauben lösen (1).
2. Die Tür herauschieben und entfernen (2).



3. 1. Die vier Schrauben entfernen (1).
2. Die Scharniere entfernen (2).

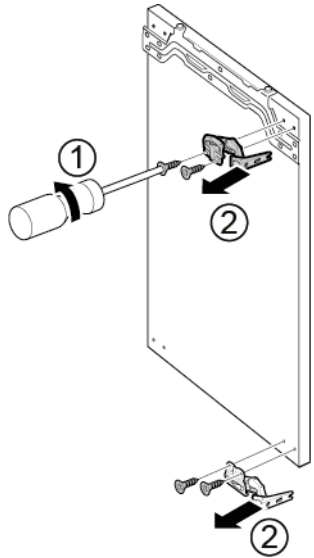

 Die Scharniere sind entfernt.

### 4.2.2 Einbauen des Flachscharniers

- ▶ Der Einbau erfolgt in umgekehrter Reihenfolge.

## 4.3 Austauschen des Schleppscharniers

### Spezielle Hilfsmittel:

🌀 Torx-Bit TX20      6,3 mm (1/4")      [00340865]

	<b>⚠️ WARNUNG</b>
	<p><b>Schwere, unhandliche Geräte!</b> Rücken- und Muskelverletzungen</p> <ul style="list-style-type: none"> <li>▶ Der Ausbau der Gerätetür sollte nur von geschulten Spezialisten durchgeführt werden.</li> <li>▶ Zum Bewegen des Geräts sind zwei Personen erforderlich.</li> <li>▶ Nur geeignete Werkzeuge und Vorrichtungen verwenden.</li> </ul>

	<b>⚠️ VORSICHT</b>
	<p><b>Scharfe Kanten!</b> Schnittverletzungen</p> <ul style="list-style-type: none"> <li>▶ Schutzhandschuhe tragen.</li> </ul>

	<b>⚠️ VORSICHT</b>
	<p><b>Risiko herabfallender Teile durch gelöste Schrauben!</b> Verletzungsgefahr durch herabfallende Teile.</p> <ul style="list-style-type: none"> <li>▶ Die Komponenten gegen Herunterfallen sichern.</li> </ul>

	<b>⚠️ ACHTUNG</b>
	<p><b>Risiko herabfallender Teile durch gelöste Schrauben!</b> Gefahr der Beschädigung anderer Geräteteile bzw. von Beschädigungen im Haushalt des Kunden, z. B. des Bodens.</p> <ul style="list-style-type: none"> <li>▶ Die Komponenten gegen Herunterfallen sichern.</li> </ul>

### Voraussetzung:

- ✔ Das Gerät ist spannungsfrei.
- ✔ Die Möbeltür und die Gerätetür sind getrennt. Siehe Installationsanleitung.

### 4.3.1 Ausbauen des Schleppscharniers

- ▶ 1. Die beiden Schrauben heraus-schrauben (1).
- ▶ 2. Das obere Scharnier entfernen (2).
- ▶ 3. Die Tür entfernen (3).
- ▶ 4. Die beiden Schrauben heraus-schrauben (4).
- ▶ 5. Das untere Scharnier entfernen (5).

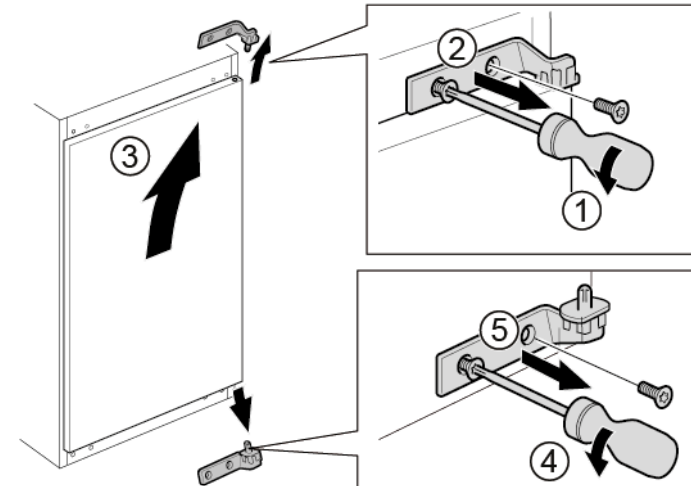

➡ Die Scharniere sind entfernt.

### 4.3.2 Einbauen des Schleppscharniers

- ▶ Der Einbau erfolgt in umgekehrter Reihenfolge.



## 4.4 Austauschen der Ablage

### Voraussetzung:

- ✔ Die Tür ist offen.

### 4.4.1 Ausbauen der Ablage

- ▶ Die Ablage herausziehen.



- ➡ Die Ablage ist entfernt.

### 4.4.2 Einbauen der Ablage

- ▶ Der Einbau erfolgt in umgekehrter Reihenfolge.

## 4.5 Austauschen des Türabstellers

Voraussetzung:

- ✔ Die Tür ist offen.

### 4.5.1 Ausbauen des Türabstellers

- ▶ Den Türabsteller anheben.



➡ Der Türabsteller ist entfernt.

### 4.5.2 Einbauen des Türabstellers

- ▶ Der Einbau erfolgt in umgekehrter Reihenfolge.

## 4.6 Austauschen des Obst- und Gemüsebehälters

### Voraussetzung:

- ✔ Die Tür ist offen.

### 4.6.1 Ausbauen des Obst- und Gemüsebehälters

1. Den Obst- und Gemüsebehälter bis zum Anschlag herausziehen.
2. 1. Den Obst- und Gemüsebehälter vorn anheben (1).  
2. Den Behälter entfernen (2).



- ➡ Der Obst- und Gemüsebehälter ist entfernt.

### 4.6.2 Einbauen des Obst- und Gemüsebehälters

- ▶ Der Einbau erfolgt in umgekehrter Reihenfolge.

## 4.7 Austauschen der seitlichen LED-Beleuchtung

### Spezielle Hilfsmittel:

 Saugnapf Ø50 mm [00342224]

 Ihr Gerät ist mit einer wartungsfreien LED-Beleuchtung ausgestattet. Reparaturen an dieser Beleuchtung dürfen nur vom Kundendienst oder von autorisierten Fachkräften ausgeführt werden!

 **GEFAHR**  
**Stromschlaggefahr durch spannungsführende Teile!**  
 Lebensgefahr durch Stromschlag bei unsachgemäßer Reparatur

- ▶ Elektroteile sollten von einer Elektrofachkraft repariert werden.
- ▶ Nach der Reparatur muss eine Sicherheitsprüfung nach VDE 0701 oder länderspezifischen Vorschriften durchgeführt werden.



 **GEFAHR**  
**Stromschlaggefahr durch spannungsführende Teile!**  
 Tod durch Stromschlag

- ▶ Gerät mindestens 60 Sekunden vor Reparaturbeginn vom Netz trennen.

 **VORSICHT**  
**Scharfe Kanten!**  
 Schnittverletzungen

- ▶ Schutzhandschuhe tragen.

### Voraussetzung:

-  Das Gerät ist spannungsfrei.
-  Die Tür ist offen.
-  Die Ablagen sind entfernt.

### 4.7.1 Ausbauen der seitlichen LED-Beleuchtung

1. Zwei Saugnäpfe an der Abdeckung der seitlichen LED Beleuchtung anbringen.

2. Die Saugnäpfe mit einer Drehbewegung nach vorn ziehen.

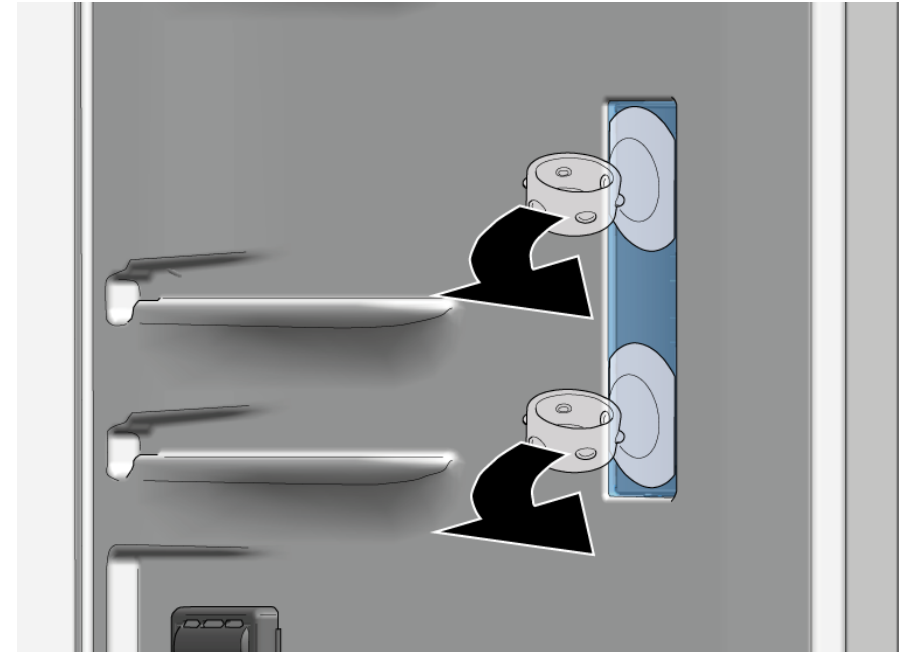

 Die Abdeckung der LED-Beleuchtung ist entfernt.

3. Das LED-Modul entfernen.



 Die seitliche LED-Beleuchtung ist entfernt.





### 4.7.2 Einbauen der seitlichen LED-Beleuchtung



Da die Haken der seitlichen Leuchtenabdeckung beim Entfernen leicht brechen können, besteht das Ersatzteil aus dem LED-Modul und der Leuchtenabdeckung.

► Der Einbau erfolgt in umgekehrter Reihenfolge.

# Υποδείξεις επισκευής - Ψυγείο

 <b>Σχετικά με αυτό το έγγραφο</b> .....	<b>163</b>
1.1 Σημαντικές πληροφορίες .....	163
1.1.1 Σκοπός.....	163
1.2 Επεξήγηση συμβόλων .....	163
1.2.1 Επίπεδα κινδύνου .....	163
1.2.2 Σύμβολα κινδύνου.....	163
1.2.3 Δομή των προειδοποιήσεων .....	164
1.2.4 Γενικά σύμβολα .....	164
 <b>Ασφάλεια</b> .....	<b>165</b>
2.1 Γενικές οδηγίες ασφαλείας .....	165
2.1.1 Όλες οι οικιακές συσκευές .....	165
 <b>Εργαλεία και βοηθήματα</b> .....	<b>166</b>
 <b>Επισκευή</b> .....	<b>167</b>
4.1 Αντικατάσταση στεγανοποιητικού πόρτας .....	167
4.1.1 Αφαίρεση στεγανοποιητικού πόρτας.....	167
4.1.2 Τοποθέτηση στεγανοποιητικού πόρτας .....	167
4.2 Αντικατάσταση επίπεδου μεντεσέ .....	170
4.2.1 Αφαίρεση επίπεδου μεντεσέ .....	170
4.2.2 Τοποθέτηση επίπεδου μεντεσέ .....	171
4.3 Αντικατάσταση συρόμενου μεντεσέ.....	172
4.3.1 Αφαίρεση συρόμενου μεντεσέ.....	172
4.3.2 Τοποθέτηση συρόμενου μεντεσέ.....	172
4.4 Αντικατάσταση ραφιού .....	173
4.4.1 Αφαίρεση ραφιού .....	173
4.4.2 Τοποθέτηση ραφιού .....	173
4.5 Αντικατάσταση ραφιού πόρτας .....	174
4.5.1 Αφαίρεση ραφιού πόρτας .....	174
4.5.2 Τοποθέτηση ραφιού πόρτας .....	174
4.6 Αντικατάσταση συρταριού φρούτων και λαχανικών .....	175
4.6.1 Αφαίρεση συρταριού φρούτων και λαχανικών .....	175
4.6.2 Τοποθέτηση συρταριού φρούτων και λαχανικών .....	175
4.7 Αντικατάσταση πλευρικού φωτός LED .....	176
4.7.1 Αφαίρεση πλευρικού φωτός LED .....	176
4.7.2 Τοποθέτηση πλευρικού φωτός LED .....	177

# **i** Σχετικά με αυτό το έγγραφο

## 1.1 Σημαντικές πληροφορίες

### 1.1.1 Σκοπός

Αυτές οι συμβουλές επισκευών υποστηρίζουν τους καταναλωτές στην επισκευή των συσκευών από τους ίδιους, σύμφωνα με τον ισχύοντα κανονισμό οικολογικού σχεδιασμού (από τις 03/2021).

Περιέχουν πληροφορίες για την αντικατάσταση ορισμένων ανταλλακτικών, συμπεριλαμβανομένων προειδοποιήσεων και κινδύνων.

Σε περίπτωση ερωτήσεων, επικοινωνήστε με το τμήμα εξυπηρέτησης πελατών της εταιρείας μας. Φέρουμε ευθύνη για τις ζημιές εάν οι συμβουλές επισκευής έχουν ακολουθηθεί σωστά.

## 1.2 Επεξήγηση συμβόλων

### 1.2.1 Επίπεδα κινδύνου

Τα επίπεδα προειδοποίησης ασφάλειας αποτελούνται από ένα σύμβολο και μια λέξη. Η λέξη προειδοποίησης προσδιορίζει τη σοβαρότητα του κινδύνου.





Επίπεδο προειδοποίησης	Σημασία
	Η μη τήρηση του προειδοποιητικού μηνύματος θα οδηγήσει σε θάνατο ή σε σοβαρούς τραυματισμούς.
	Η μη τήρηση του προειδοποιητικού μηνύματος θα μπορούσε να οδηγήσει σε θάνατο ή σε σοβαρούς τραυματισμούς.
	Η μη τήρηση του προειδοποιητικού μηνύματος θα μπορούσε να οδηγήσει σε μικρούς τραυματισμούς.
	Η μη τήρηση του προειδοποιητικού μηνύματος θα μπορούσε να οδηγήσει σε υλικές ζημιές της ιδιοκτησίας.

Πίνακας 1: Επίπεδα κινδύνου





### 1.2.2 Σύμβολα κινδύνου

Τα σύμβολα κινδύνου είναι συμβολικές αναπαραστάσεις που δίνουν μια ένδειξη για το είδος του κινδύνου.

Τα ακόλουθα σύμβολα κινδύνου χρησιμοποιούνται στο παρόν έγγραφο:

Σύμβολο κινδύνου	Σημασία
	Γενικό προειδοποιητικό μήνυμα
	Κίνδυνος από ηλεκτρική τάση
	Κίνδυνος έκρηξης
	Κίνδυνος κοψίματος

## **i** Σχετικά με αυτό το έγγραφο

Σύμβολο κινδύνου	Σημασία
	Κίνδυνος σύνθλιψης
	Κίνδυνος από καυτές επιφάνειες
	Κίνδυνος από ισχυρό μαγνητικό πεδίο
	Κίνδυνος από μη ιονίζουσα ακτινοβολία

Πίνακας 2: Σύμβολα κινδύνου

### 1.2.3 Δομή των προειδοποιήσεων

.Οι προειδοποιήσεις σε αυτό το έγγραφο έχουν μια τυποποιημένη εμφάνιση και μια τυποποιημένη δομή.









	<b>⚠ ΚΙΝΔΥΝΟΣ</b>
<b>Είδος και πηγή κινδύνου!</b> Πιθανές συνέπειες εάν αγνοήσετε τον κίνδυνο/την προειδοποίηση. ▶ Μέτρα και απαγορεύσεις για την πρόληψη του κινδύνου.	

Το παρακάτω παράδειγμα δείχνει μια προειδοποίηση που προειδοποιεί κατά της ηλεκτροπληξίας λόγω ηλεκτροφόρων μερών. Αναφέρεται το μέτρο για την αποφυγή του κινδύνου.

	<b>⚠ ΚΙΝΔΥΝΟΣ</b>
<b>Κίνδυνος ηλεκτροπληξίας λόγω ηλεκτροφόρων μερών!</b> Θάνατος από ηλεκτροπληξία ▶ Αποσυνδέετε τις συσκευές από την παροχή ηλεκτρικού ρεύματος τουλάχιστον 60 δευτερόλεπτα πριν ξεκινήσετε τις επισκευές.	

### 1.2.4 Γενικά σύμβολα

Τα ακόλουθα γενικά σύμβολα χρησιμοποιούνται στο παρόν έγγραφο:

Γεν. σύμβολο	Σημασία
	Ταυτοποίηση μιας ειδικής συμβουλής (κειμένου ή/και γραφικών)
	Ταυτοποίηση μιας ειδικής συμβουλής (μόνο κειμένου)
	Ταυτοποίηση συνδέσμου ή εκπαιδευτικού βίντεο
	Ταυτοποίηση απαραίτητων εργαλείων
	Ταυτοποίηση απαραίτητων προϋποθέσεων
	Ταυτοποίηση μιας συνθήκης (αν ..., κατόπιν ...)
	Ταυτοποίηση αποτελέσματος
	Ταυτοποίηση ενός πλήκτρου ή κουμπιού
[00123456]	Ταυτοποίηση ενός κωδικού ανταλλακτικού
Κατάσταση	Ταυτοποίηση εμφανιζόμενου κειμένου/ παραθύρου (στην οθόνη της συσκευής)

Πίνακας 3: Γενικά σύμβολα



## 2.1 Γενικές οδηγίες ασφαλείας

### 2.1.1 Όλες οι οικιακές συσκευές

#### **Κίνδυνος ηλεκτροπληξίας λόγω ηλεκτροφόρων μερών!**

- Τα σφάλματα από επισκευές σε ηλεκτρικά εξαρτήματα μπορεί να προκαλέσουν ηλεκτροπληξία!
- Αποσυνδέστε τη συσκευή από την πρίζα για τουλάχιστον 60 δευτερόλεπτα πριν από την έναρξη των εργασιών.
- Μετά την επισκευή πραγματοποιήστε έλεγχο ασφαλείας σύμφωνα με το VDE 0701 ή κανονισμούς της συγκεκριμένης χώρας.

#### **Κίνδυνος τραυματισμού από κοφτερές άκρες!**

- Φοράτε προστατευτικά γάντια.

#### **Κίνδυνος σύνθλιψης κατά την επισκευή, συντήρηση, αντιμετώπιση προβλημάτων και το σέρβις από βαριά και κινούμενα μέρη**

- Φοράτε προστατευτικά υποδήματα.
- Ασφαλίστε τα βαριά μέρη από πτώση.
- Μην προσαρτάτε μέρη του πλαισίου στα κινούμενα μέρη.



#### **Κίνδυνος για την ασφάλεια/τη λειτουργία της συσκευής!**

- Χρησιμοποιείτε μόνο γνήσια ανταλλακτικά.

#### **Κίνδυνος πρόκλησης βλάβης σε μέρη ευαίσθητα στον στατικό ηλεκτρισμό (ESDs)!**

- Μην αγγίζετε τις μονάδες, συμπεριλαμβανομένων των συνδέσεων και των αγωγών των πλακετών.

## Εργαλεία και βοηθήματα

Όνομασία	Λεπτομέριες	Εικόνες
Πανάκι προστασίας [00342013]	60 cm x 50 cm	
Βεντούζα [00342224]	Ø50 mm	
Μύτη Torx TX20 [00340865]	6,3 mm (1/4")	

## 4.1 Αντικατάσταση στεγανοποιητικού πόρτας

### Προϋπόθεση:

- ✔ Η πόρτα είναι ανοιχτή.

### 4.1.1 Αφαίρεση στεγανοποιητικού πόρτας

1. Απελευθερώστε το στεγανοποιητικό πόρτας από την εγκοπή στη δεξιά και αριστερή γωνία.

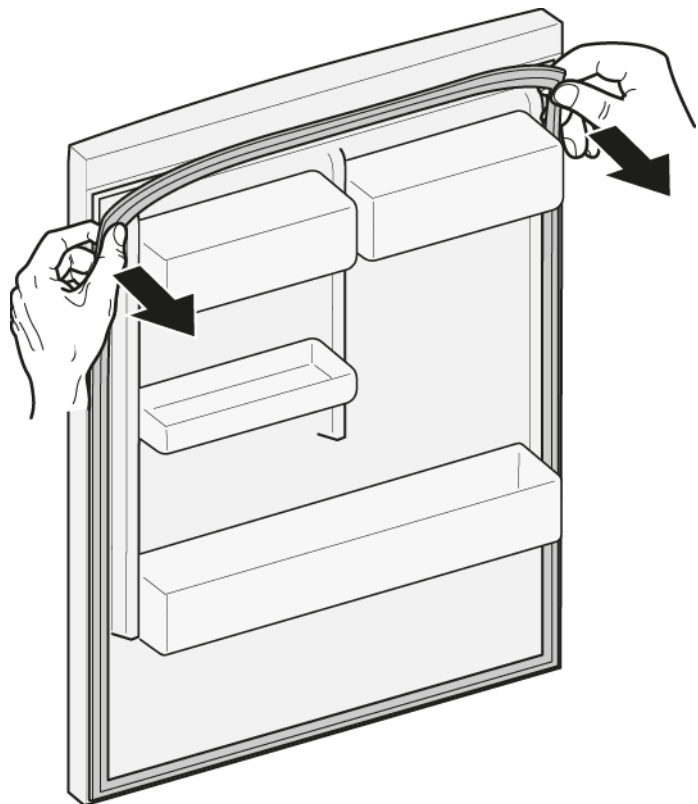

2. Τραβήξτε το στεγανοποιητικό πόρτας έξω από την εγκοπή.



- ➡ Το στεγανοποιητικό της πόρτας έχει αφαιρεθεί.

### 4.1.2 Τοποθέτηση στεγανοποιητικού πόρτας



Το πάχος του νέου στεγανοποιητικού πόρτας μπορεί να αποκλίνει ελαφρώς από το πάχος του παλαιού στεγανοποιητικού πόρτας. Αυτό δεν θα επηρεάσει τη συμπεριφορά κλεισίματος και τη μακροπρόθεσμη λειτουργία.

Εάν η συσκευή σας έχει προσαρμοζόμενους μεντεσέδες ή προσαρτήματα μεντεσέ, μπορεί να βελτιστοποιήσετε τη συμπεριφορά κλεισίματος αργότερα.

Οι μικρές οπές πλευρικά στο στεγανοποιητικό της πόρτας είναι λειτουργικές (απαραίτητες για τον αερισμό). Δεν είναι κατασκευαστικά ελαττώματα.

1. Ελέγξτε την εγκοπή για το στεγανοποιητικό για ζημιές.



4. Πιέστε τις γωνίες του στεγανοποιητικού επάνω και κάτω στην εγκοπή.

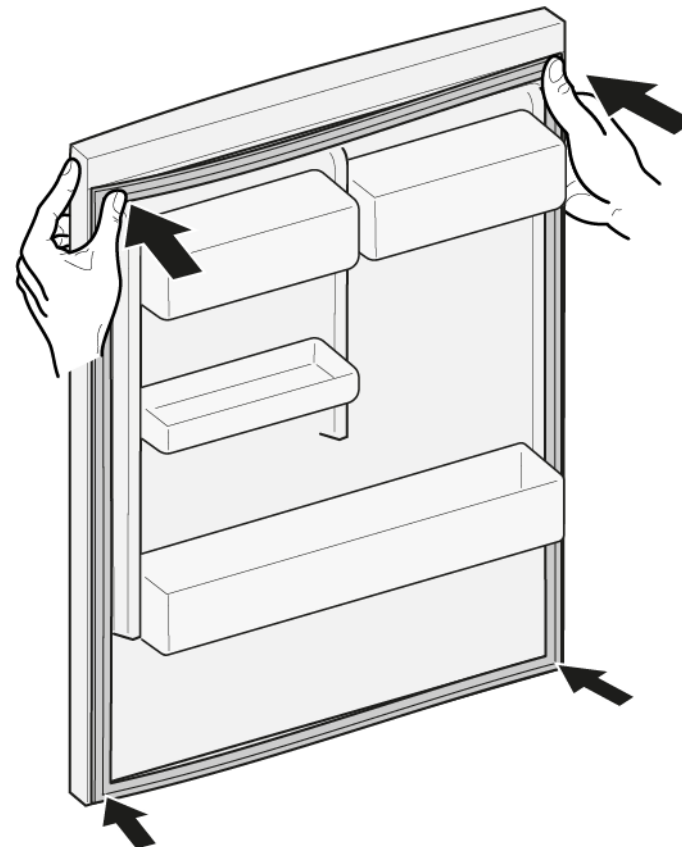



2. ⓘ Εάν η εγκοπή για στεγανοποιητικό είναι κατεστραμμένη.  
- Επικοινωνήστε με την εξυπηρέτηση πελατών.

3. ⓘ Η ελαφριά παραμόρφωση του στεγανοποιητικού της πόρτας είναι φυσιολογική και δεν επηρεάζει τη λειτουργία της. Συνιστάται να ισιώνετε το στεγανοποιητικό της πόρτας πριν την τοποθετήσετε στη συσκευή.

Θερμάνετε το στεγανοποιητικό της πόρτας με πιστολάκι ή ζεστό νερό και αλλάξτε το σχήμα του με το χέρι.

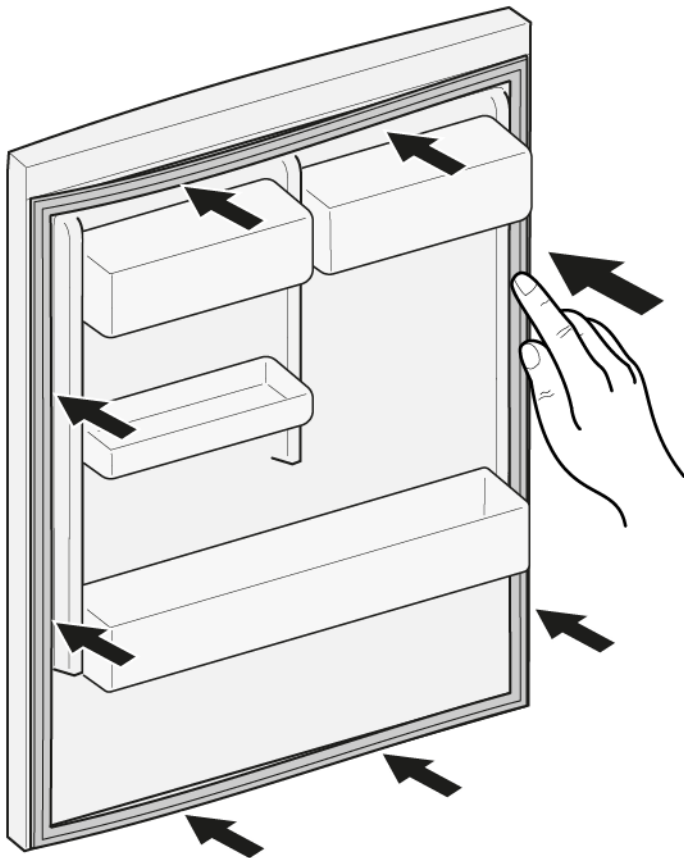
5. Πιέστε ολόκληρο το στεγανοποιητικό βήμα βήμα στο εσωτερικό της εγκοπής.



-  Το στεγανοποιητικό της πόρτας τοποθετήθηκε.

## 4.2 Αντικατάσταση επίπεδου μεντεσέ

Ειδικά βοηθητικά μέσα:

Μύτη Torx TX20

6,3 mm (1/4")

[00340865]

	<b>ΠΡΟΕΙΔΟΠΟΙΗΣΗ</b>
	<p><b>Βαριές, ογκώδεις συσκευές!</b> Τραυματισμοί μέσης και μυών</p> <ul style="list-style-type: none"> <li>▶ Η διαδικασία αφαίρεσης της πόρτας της συσκευής πρέπει να εκτελείται μόνο από εκπαιδευμένους ειδικούς.</li> <li>▶ Η μετακίνηση της συσκευής πρέπει να εκτελείται από δύο άτομα.</li> <li>▶ Χρησιμοποιείτε μόνο κατάλληλα εργαλεία και εξοπλισμό.</li> </ul>

	<b>ΠΡΟΣΟΧΗ</b>
	<p><b>Αιχμηρές ακμές!</b> Τραυματισμοί από κοπή</p> <ul style="list-style-type: none"> <li>▶ Φοράτε προστατευτικά γάντια.</li> </ul>

	<b>ΠΡΟΣΟΧΗ</b>
	<p><b>Ανοίξτε την περιοχή με τους μεντεσέδες!</b> Σύνθλιψη/παγίδευση δακτύλων</p> <ul style="list-style-type: none"> <li>▶ Μην αγγίζετε την περιοχή με τους μεντεσέδες.</li> <li>▶ Φοράτε προστατευτικά γάντια.</li> </ul>

	<b>ΠΡΟΣΟΧΗ</b>
	<p><b>Κίνδυνοι από πτώση μερών εξαιτίας χαλαρών βιδών!</b> Τραυματισμός εξαιτίας πτώσης τμημάτων.</p> <ul style="list-style-type: none"> <li>▶ Ασφαλίστε τα εξαρτήματα από πτώση.</li> </ul>

	<b>ΠΡΟΣΟΧΗ!</b>
	<p><b>Κίνδυνων από πτώση εξαρτημάτων εξαιτίας χαλαρών βιδών!</b> Ζημιά σε άλλα μέρη της συσκευής ή στην οικία του πελάτη, π.χ. δάπεδο.</p> <ul style="list-style-type: none"> <li>▶ Ασφαλίστε τα εξαρτήματα από πτώση.</li> </ul>

Προϋπόθεση:

- ✔ Η συσκευή είναι αποσυνδεδεμένη από την παροχή τροφοδοσίας.
- ✔ Η πόρτα ντουλαπιού έχει αφαιρεθεί. Βλέπε οδηγίες εγκατάστασης.
- ✔ Η πόρτα είναι ανοιχτή.

### 4.2.1 Αφαίρεση επίπεδου μεντεσέ

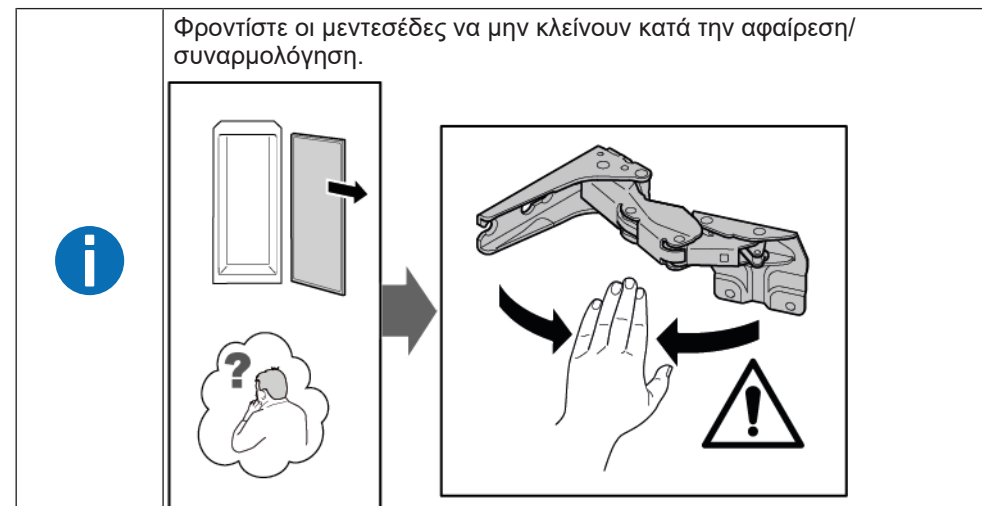

1. Αφαιρέστε δύο καλύμματα μεντεσέ.

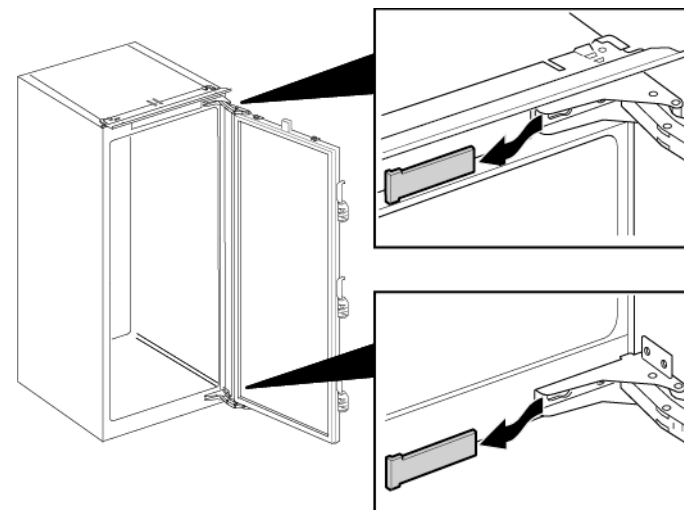

2. 1. Χαλαρώστε τέσσερις βίδες (1).
2. Σύρετε προς τα έξω και αφαιρέστε την πόρτα (2).

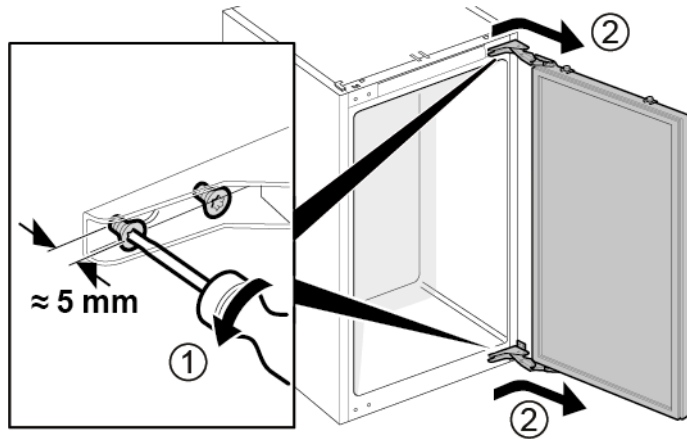

3. 1. Αφαιρέστε τέσσερις βίδες (1).
2. Αφαιρέστε τους μεντεσέδες (2).

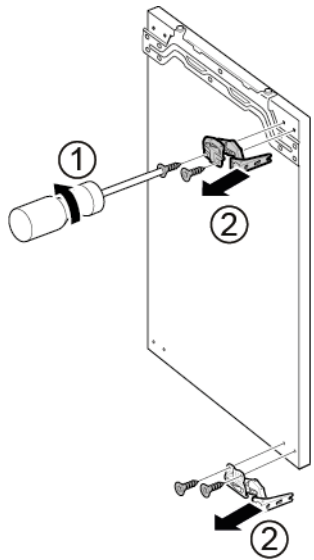

 Οι μεντεσέδες έχουν αφαιρεθεί.

### 4.2.2 Τοποθέτηση επίπεδου μεντεσέ

- Εγκαταστήστε με την αντίθετη σειρά.

### 4.3 Αντικατάσταση συρόμενου μεντεσέ

Ειδικά βοηθητικά μέσα:

 Μύτη Torx TX20      6,3 mm (1/4")      [00340865]



	<b>⚠ ΠΡΟΕΙΔΟΠΟΙΗΣΗ</b>
	<p><b>Βαριές, ογκώδεις συσκευές!</b> Τραυματισμοί μέσης και μυών</p> <ul style="list-style-type: none"> <li>▶ Η διαδικασία αφαίρεσης της πόρτας της συσκευής πρέπει να εκτελείται μόνο από εκπαιδευμένους ειδικούς.</li> <li>▶ Η μετακίνηση της συσκευής πρέπει να εκτελείται από δύο άτομα.</li> <li>▶ Χρησιμοποιείτε μόνο κατάλληλα εργαλεία και εξοπλισμό.</li> </ul>

	<b>⚠ ΠΡΟΣΟΧΗ</b>
	<p><b>Αιχμηρές ακμές!</b> Τραυματισμοί από κοπή</p> <ul style="list-style-type: none"> <li>▶ Φοράτε προστατευτικά γάντια.</li> </ul>

	<b>⚠ ΠΡΟΣΟΧΗ</b>
	<p><b>Κίνδυνοι από πτώση μερών εξαιτίας χαλαρών βιδών!</b> Τραυματισμός εξαιτίας πτώσης τμημάτων.</p> <ul style="list-style-type: none"> <li>▶ Ασφαλίστε τα εξαρτήματα από πτώση.</li> </ul>

	<b>ΠΡΟΣΟΧΗ!</b>
	<p><b>Κίνδυνων από πτώση εξαρτημάτων εξαιτίας χαλαρών βιδών!</b> Ζημιά σε άλλα μέρη της συσκευής ή στην οικία του πελάτη, π.χ. δάπεδο.</p> <ul style="list-style-type: none"> <li>▶ Ασφαλίστε τα εξαρτήματα από πτώση.</li> </ul>

**Προϋπόθεση:**

-  Η συσκευή είναι αποσυνδεδεμένη από την παροχή τροφοδοσίας.
-  Η πόρτα ντουλαπιού και η πόρτα συσκευής είναι διαχωρισμένες. Βλέπε οδηγίες εγκατάστασης.

#### 4.3.1 Αφαίρεση συρόμενου μεντεσέ

- ▶ 1. Ξεβιδώστε δύο βίδες (1).
- ▶ 2. Αφαιρέστε τον επάνω μεντεσέ (2).
- ▶ 3. Αφαιρέστε την πόρτα (3).
- ▶ 4. Ξεβιδώστε δύο βίδες (4).
- ▶ 5. Αφαιρέστε τον κάτω μεντεσέ (5).

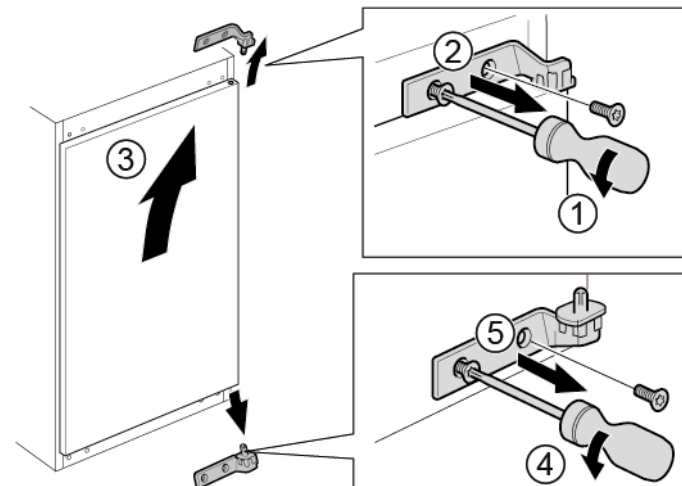

 Οι μεντεσέδες έχουν αφαιρεθεί.

#### 4.3.2 Τοποθέτηση συρόμενου μεντεσέ

- ▶ Εγκαταστήστε με την αντίθετη σειρά.



#### 4.4 Αντικατάσταση ραφιού

Προϋπόθεση:

- ✔ Η πόρτα είναι ανοιχτή.

##### 4.4.1 Αφαίρεση ραφιού

- ▶ Τραβήξτε το ράφι προς τα έξω.



- ➡ Το ράφι αφαιρέθηκε.

##### 4.4.2 Τοποθέτηση ραφιού

- ▶ Εγκαταστήστε με την αντίθετη σειρά.

## 4.5 Αντικατάσταση ραφιού πόρτας

Προϋπόθεση:

- ✔ Η πόρτα είναι ανοιχτή.

### 4.5.1 Αφαίρεση ραφιού πόρτας

- ▶ Ανασηκώστε το ράφι πόρτας προς τα επάνω.

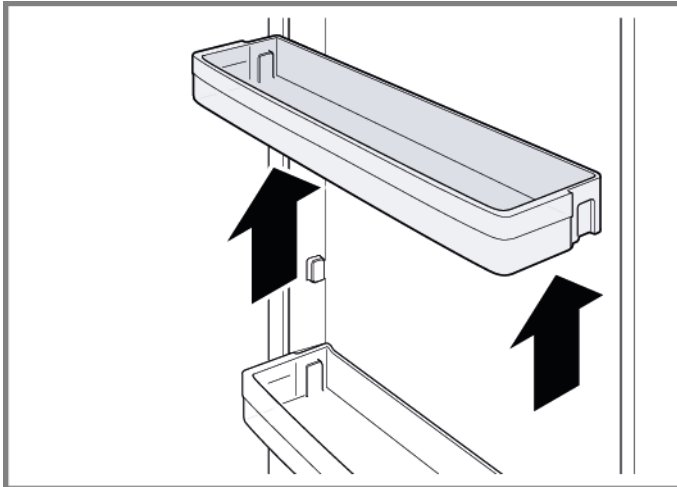

- ➡ Το ράφι πόρτας έχει αφαιρεθεί.

### 4.5.2 Τοποθέτηση ραφιού πόρτας

- ▶ Εγκαταστήστε με την αντίθετη σειρά.

## 4.6 Αντικατάσταση συρταριού φρούτων και λαχανικών

Προϋπόθεση:

- ✔ Η πόρτα είναι ανοιχτή.

### 4.6.1 Αφαίρεση συρταριού φρούτων και λαχανικών

1. Τραβήξτε προς τα έξω το δοχείο φρούτων και λαχανικών μέχρι τέρμα.
2. 1. Ανασηκώστε το δοχείο φρούτων και λαχανικών μπροστά (1).  
2. Αφαιρέστε το συρτάρι (2).



- ➡ Το δοχείο φρούτων και λαχανικών έχει αφαιρεθεί.

### 4.6.2 Τοποθέτηση συρταριού φρούτων και λαχανικών

- ▶ Εγκαταστήστε με την αντίθετη σειρά.

## 4.7 Αντικατάσταση πλευρικού φωτός LED

Ειδικά βοηθητικά μέσα:

Βεντούζα Ø50 mm [00342224]

**i** Η συσκευή διαθέτει ένα φως LED που δεν χρειάζεται συντήρηση. Αυτά τα φώτα μπορούν να επισκευαστούν μόνο από την εξυπηρέτηση πελατών ή από εξουσιοδοτημένους τεχνικούς!

**⚠ ΚΙΝΔΥΝΟΣ**  
**Κίνδυνος ηλεκτροπληξίας λόγω ηλεκτροφόρων μερών!**  
Κίνδυνος για τη ζωή από ηλεκτροπληξία σε περίπτωση ακατάλληλης επισκευής

- ▶ Τα ηλεκτρικά μέρη πρέπει να επισκευάζονται από εκπαιδευμένους ηλεκτρολόγους.
- ▶ Μετά την επισκευή πραγματοποιήστε έλεγχο ασφάλειας σύμφωνα με το VDE 0701 ή κανονισμούς της συγκεκριμένης χώρας.

**⚠ ΚΙΝΔΥΝΟΣ**  
**Κίνδυνος ηλεκτροπληξίας λόγω ηλεκτροφόρων μερών!**  
Θάνατος από ηλεκτροπληξία

- ▶ Αποσυνδέετε τις συσκευές από την παροχή ηλεκτρικού ρεύματος τουλάχιστον 60 δευτερόλεπτα πριν ξεκινήσετε τις επισκευές.

**⚠ ΠΡΟΣΟΧΗ**  
**Αιχμηρές ακμές!**  
Τραυματισμοί από κοπή

- ▶ Φοράτε προστατευτικά γάντια.

Προϋπόθεση:

- ✓ Η συσκευή είναι αποσυνδεδεμένη από την παροχή τροφοδοσίας.
- ✓ Η πόρτα είναι ανοιχτή.
- ✓ Τα ράφια έχουν αφαιρεθεί.

### 4.7.1 Αφαίρεση πλευρικού φωτός LED

1. Κολλήστε δύο βεντούζες στο κάλυμμα πλευρικού φωτός LED.

2. Τραβήξτε τις βεντούζες προς το μέρος σας με μια περιστροφική κίνηση.

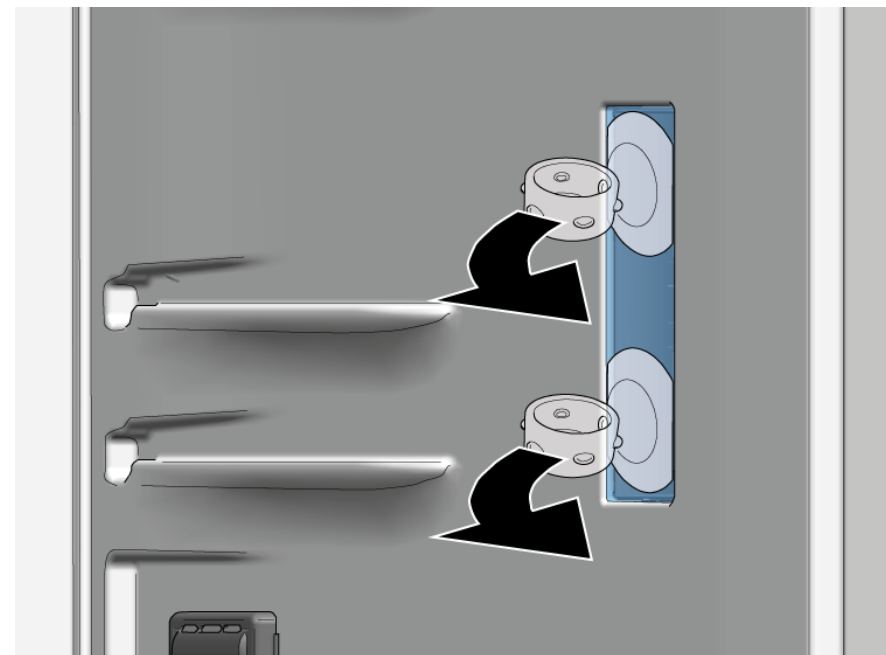

➡ Το κάλυμμα φωτός LED αφαιρέθηκε.

3. Αφαιρέστε τη μονάδα LED.



 Το πλευρικό φως LED αφαιρέθηκε.

### 4.7.2 Τοποθέτηση πλευρικού φωτός LED



Επειδή τα άγκιστρα του καλύμματος λάμπας είναι εύκολο να σπάσουν κατά τη διαδικασία αφαίρεσης, το ανταλλακτικό πλευρικό φως LED είναι το σετ που περιλαμβάνει τη μονάδα LED και το κάλυμμα φωτός.

- ▶ Εγκαταστήστε με την αντίθετη σειρά.

# Javítási útmutató - Hűtőszekrény

 <b>A dokumentummal kapcsolatos információk.....</b>	<b>179</b>
1.1 Fontos tudnivalók .....	179
1.1.1 Cél .....	179
1.2 Szimbólummagyarázat .....	179
1.2.1 Veszélyességi szintek .....	179
1.2.2 Veszélyt jelző szimbólumok .....	179
1.2.3 A figyelmeztetések felépítése .....	180
1.2.4 Általános szimbólumok.....	180
 <b>Biztonság .....</b>	<b>181</b>
2.1 Általános biztonsági utasítások.....	181
2.1.1 Összes háztartási készülék .....	181
 <b>Szerszámok és segédanyagok.....</b>	<b>182</b>
 <b>Javítás .....</b>	<b>183</b>
4.1 A gumitömítés cseréje .....	183
4.1.1 A gumitömítés eltávolítása.....	183
4.1.2 A gumitömítés beszerelése.....	183
4.2 Lapos zsanér cseréje.....	186
4.2.1 Lapos zsanér eltávolítása .....	186
4.2.2 Lapos zsanér beszerelése .....	187
4.3 A csúszózszer cseréje .....	188
4.3.1 A csúszózszer eltávolítása .....	188
4.3.2 A csúszózszer felszerelése.....	188
4.4 A polc cseréje .....	189
4.4.1 A polc eltávolítása .....	189
4.4.2 A polc beszerelése.....	189
4.5 Az ajtópolc cseréje .....	190
4.5.1 Az ajtópolc eltávolítása.....	190
4.5.2 Az ajtópolc felhelyezése .....	190
4.6 A gyümölcs- és zöldségtároló cseréje .....	191
4.6.1 A gyümölcs- és zöldségtároló eltávolítása .....	191
4.6.2 A gyümölcs- és zöldségtároló behelyezése.....	191
4.7 A LED-es oldalsó lámpa cseréje .....	192
4.7.1 LED-es oldalsó lámpa eltávolítása .....	192
4.7.2 A LED-es oldalsó lámpa beszerelése .....	193

# **i** A dokumentummal kapcsolatos információk

## 1.1 Fontos tudnivalók

### 1.1.1 Cél

Ezek a javítási tanácsok támogatják a fogyasztót a készülékek otthoni megjavításában a környezettudatos tervezésről szóló rendeletnek (2021 márciusától alkalmazandó) megfelelően.





Információkat tartalmaznak bizonyos pótalkatrészek cseréjével kapcsolatban, ideértve a figyelmeztetéseket és a kockázatokat is.

Ha kérdése van, vegye fel a kapcsolatot a vevőszolgálattal. A károkért kizárólag akkor vállalunk felelősséget, ha a javítási tanácsokat pontosan betartották.

## 1.2 Szimbólummagyarázat

### 1.2.1 Veszélyességi szintek

A veszélyességi szintek egy szimbólumból és egy figyelmeztető mondatból állnak. A figyelmeztető mondat utal a veszély súlyosságára.





Veszélyességi szint	Jelentés
 <b>VESZÉLY</b>	A figyelmeztető üzenet figyelmen kívül hagyása halált vagy súlyos sérüléseket okoz.
 <b>FIGYELMEZTETÉS</b>	A figyelmeztető üzenet figyelmen kívül hagyása halált vagy súlyos sérüléseket okozhat.
 <b>VIGYÁZAT</b>	A figyelmeztető üzenet figyelmen kívül hagyása kisebb sérüléseket okozhat.
 <b>FIGYELEM!</b>	A figyelmeztető üzenet figyelmen kívül hagyása anyagi károkat okozhat.

Táblázat 1: Veszélyességi szintek

### 1.2.2 Veszélyt jelző szimbólumok

A veszélyt jelző szimbólumok a veszélyt ábrázoló szimbolikus ábrázolások.

A jelen dokumentumban az alábbi veszélyt jelző szimbólumok használatosak:

Veszélyt jelző szimbólum	Jelentés
	Általános figyelmeztető üzenet
	Elektromos feszültség veszélye
	Robbanásveszély
	Vágásveszély
	Zúzódásveszély

## **i** A dokumentummal kapcsolatos információk

Veszélyt jelző szimbólum	Jelentés
	Forró felületek miatt fennálló veszély
	Erős mágneses mező miatt fennálló veszély
	Nem ionizáló sugárzás veszélye

Táblázat 2: Veszélyt jelző szimbólumok

### 1.2.3 A figyelmeztetések felépítése

A jelen dokumentumban lévő figyelmeztetések szabványosított megjelenésűek és felépítésűek.

	<p><b>⚠ VESZÉLY</b></p> <p><b>A veszély típusa és forrása!</b> A veszély / figyelmeztetés figyelmen kívül hagyásának lehetséges következményei.</p> <ul style="list-style-type: none"> <li>▶ A veszély megelőzésére szolgáló intézkedések és tiltások.</li> </ul>
--	---

Az alábbi példa egy olyan figyelmeztetést mutat be, amely az áram alatt lévő alkatrészek okozta áramütésre figyelmeztet. Megemlíti a veszély elkerülésére szolgáló intézkedést.

	<p><b>⚠ VESZÉLY</b></p> <p><b>Áramütés veszélye áram alatt lévő alkatrészek miatt!</b> Halálos áramütés</p> <ul style="list-style-type: none"> <li>▶ A javítás megkezdése előtt legalább 60 másodperccel válassza le a készülékeket az elektromos hálózatról.</li> </ul>
--	--

### 1.2.4 Általános szimbólumok

A jelen dokumentumban az alábbi általános szimbólumok használatosak:

Ált. szimbólum	Jelentés
	Különleges tanács (szöveg és/vagy grafika)

Ált. szimbólum	Jelentés
	Egyszerű tanács (csak szöveg)
	Videós oktatóanyagra mutató hivatkozás
	A szükséges eszközök
	A szükséges feltételek
	Feltétel (ha..., akkor...)
	Eredmény
[Indítás]	Billentyű vagy gomb
[00123456]	Anyagszám azonosítója
Állapot	Megjelenített szöveg / ablak (a készülék kijelzőjén)

Táblázat 3: Általános szimbólumok



## 2.1 Általános biztonsági utasítások

### 2.1.1 Összes háztartási készülék

#### **Áramütés veszélye áram alatt lévő alkatrészek miatt!**

- Az elektromos alkatrészek hibás javítása áramütéshez vezethet!
- A javítás megkezdése előtt legalább 60 másodperccel válassza le a készüléket az elektromos hálózatról.
- A javítás után végeztesse a VDE 0701-nek vagy az országspecifikus szabályozásoknak megfelelő vizsgálatot.

#### **Éles peremek miatt fennálló sérülésveszély!**

- Viseljen védőkesztyűt.

#### **Zúzódásveszély a javítás, karbantartás, hibaelhárítás és szervizelés során a nehéz és mozgó alkatrészek miatt**

- Viseljen védőcipőt.
- Biztosítsa leesés ellen a nehéz alkatrészeket.
- Ne dugja be a testrészeit a mozgó alkatrészek közé.



#### **Sérülhet a készülék biztonsága / működése!**

- Kizárólag eredeti pótalkatrészeket használjon.

#### **Elektrosztatikailag érzékeny alkatrészek (ESD-k) károsodásának veszélye!**

- Ne érintse meg a modulokat, ideértve a csatlakozásokat és a vezetőket.

## Szerszámok és segédanyagok

Kijelölés	Részletek	Képek
Védőrongy [00342013]	60 cm x 50 cm	
Tapadókorong [00342224]	Ø50 mm	
TX20 Torx bithegy [00340865]	6,3 mm (1/4")	

## 4.1 A gumitömítés cseréje

### Követelmény:

- ✓ Az ajtó nyitva van

### 4.1.1 A gumitömítés eltávolítása

1. Vegye ki a gumitömítést a barázdából a jobb és a bal sarokban.



2. Húzza ki a gumitömítést a barázdából.



- ➡ Eltávolította a gumitömítést.

### 4.1.2 A gumitömítés beszerelése



Az új gumitömítés vastagsága enyhén eltérhet a régi gumitömítés vastagságától. Ez nem befolyásolja az ajtócsukás módját és hosszú távú működését.

Ha a készülékében beállítható zsanérok vagy zsanérrögítések vannak, utólag optimalizálhatja a becsukás módját.

A gumitömítésben lévő apró, oldalsó lyukak funkcionálisak (a szellőzéshez szükségesek). Ezek nem gyártási hibák.

1. Ellenőrizze a barázdát sérülések szempontjából.



4. Nyomja a gumitömítés fenti és lenti sarkait a barázdába.

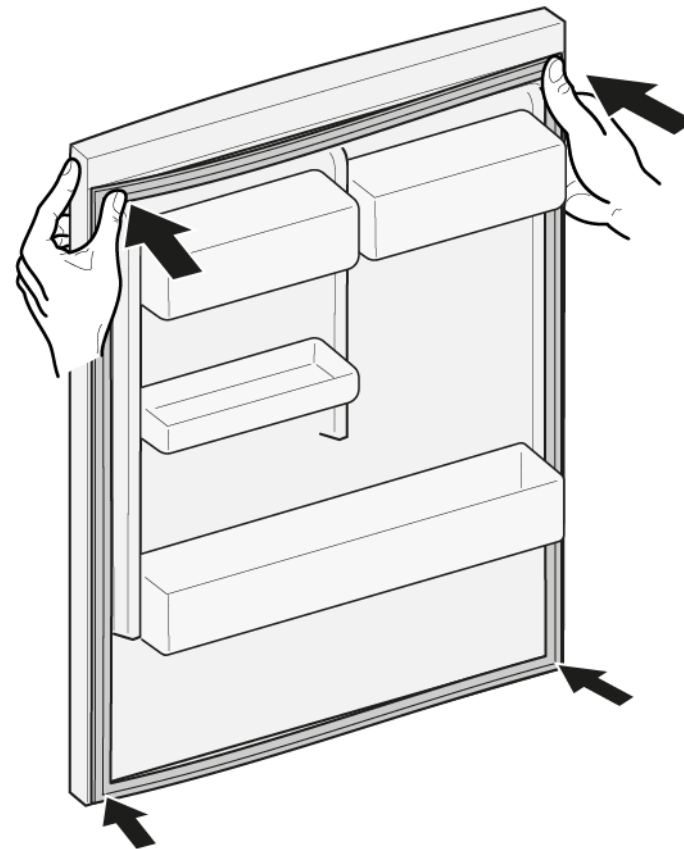



2.  Ha a gumitömítés barázdája sérült:  
- Vegye fel a kapcsolatot az ügyfélszolgálattal.

3.  A gumitömítés enyhe deformálódása normális, és nem befolyásolja a működését. Javasolt a gumitömítés kiegyenesítése a készülékbe történő behelyezés előtt.

Hajszárítóval vagy forró vízzel melegítse fel a gumitömítést, és kézzel formázza újra.

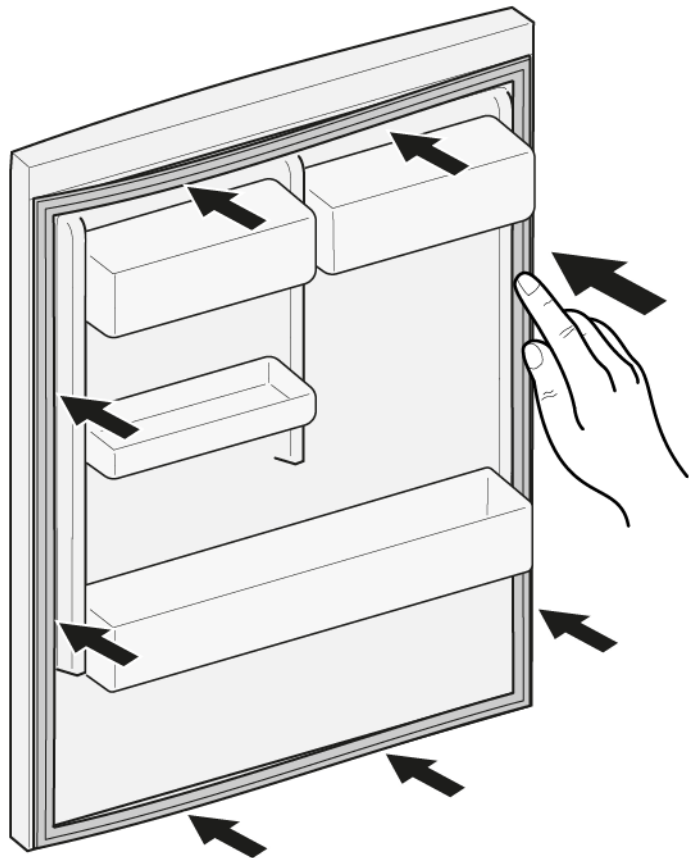
5. Nyomja a teljes gumitömítést apránként a barázdába.



-  Beszerelte a gumitömítést.

## 4.2 Lapos zsanér cseréje

### Különleges eszközök

TX20 Torx bithegy

6,3 mm (1/4")

[00340865]

**⚠ FIGYELMEZTETÉS**

**Nehéz, nagy készülékek!**  
Hát- és izomsérülések

- ▶ A készülék ajtajának eltávolítását kizárólag szakemberrel végeztesse.
- ▶ A készülék elmozdításához két emberre van szükség.
- ▶ Kizárólag megfelelő eszközöket és berendezéseket használjon.

**⚠ VIGYÁZAT**

**Éles szélek!**  
Vágási sérülések

- ▶ Viseljen védőkesztyűt.

**⚠ VIGYÁZAT**

**Nyitott zsanér!**  
Ujjak zúzódása/beszorulása

- ▶ Ne nyúljon be a nyitott zsanérba.
- ▶ Viseljen védőkesztyűt.

**⚠ VIGYÁZAT**

**Leeső alkatrészek veszélye a kioldott csavarok miatt!**  
Leeső alkatrészek miatti sérülés.

- ▶ Biztosítsa az alkatrészt leesés ellen.

**FIGYELEM!**

**Leeső alkatrészek veszélye a kioldott csavarok miatt!**  
A készülék többi részeinek vagy az ügyfél lakásának (pl. padló) károsodása.

- ▶ Biztosítsa az alkatrészt leesés ellen.

### Követelmény:

- ✓ A készüléket leválasztotta az áramellátásról.
- ✓ Eltávolította a bútorajtót. Lásd a Beszerelési útmutatót.
- ✓ Az ajtó nyitva van

### 4.2.1 Lapos zsanér eltávolítása

Figyeljen arra, hogy eltávolítás/beszereles közben a zsanérok ne csukódjanak be.

1. Távolítsa el a két zsanérburkolatot.

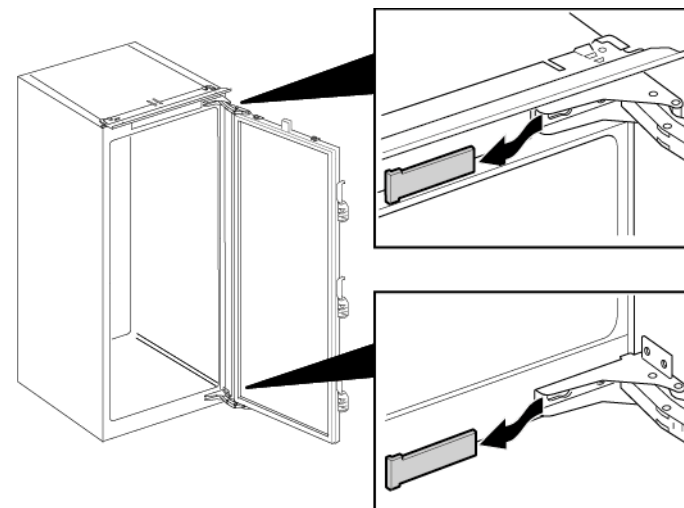

2. 1. Lazítsa meg a négy csavart (1).
2. Csúsztassa ki és vegye le az ajtót (2).

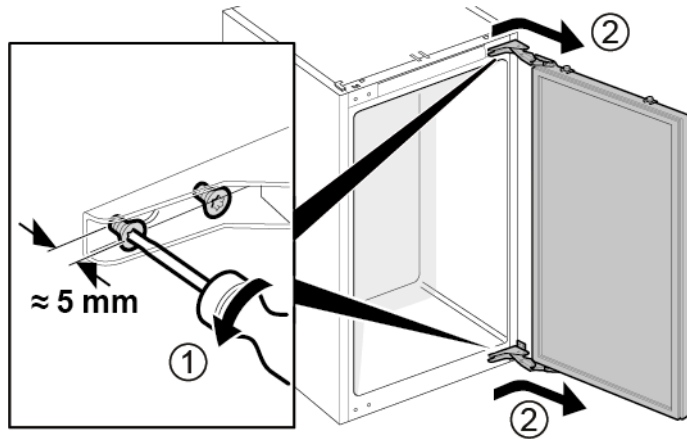

3. 1. Távolítsa el a négy csavart (1).
2. Távolítsa el a zsanérokat (2).

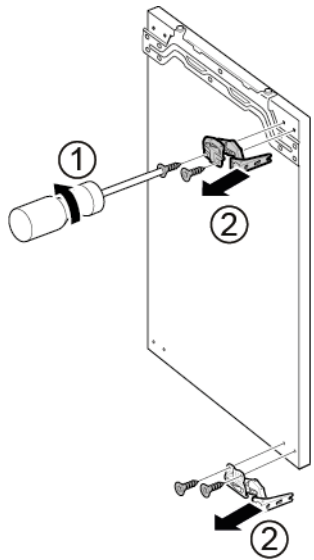

 Eltávolította a zsanérokat.

## 4.2.2 Lapos zsanér beszerelése

- ▶ Az elhelyezést fordított sorrendben végezze.

## 4.3 A csúszózsánér cseréje

### Különleges eszközök

TX20 Torx bithegy

6,3 mm (1/4")

[00340865]

	<b>⚠ FIGYELMEZTETÉS</b>
	<p><b>Nehéz, nagy készülékek!</b> Hát- és izomsérülések</p> <ul style="list-style-type: none"> <li>▶ A készülék ajtajának eltávolítását kizárólag szakemberrel végeztesse.</li> <li>▶ A készülék elmozdításához két emberre van szükség.</li> <li>▶ Kizárólag megfelelő eszközöket és berendezéseket használjon.</li> </ul>

	<b>⚠ VIGYÁZAT</b>
	<p><b>Éles szélek!</b> Vágási sérülések</p> <ul style="list-style-type: none"> <li>▶ Viseljen védőkesztyűt.</li> </ul>

	<b>⚠ VIGYÁZAT</b>
	<p><b>Leeső alkatrészek veszélye a kioldott csavarok miatt!</b> Leeső alkatrészek miatti sérülés.</p> <ul style="list-style-type: none"> <li>▶ Biztosítsa az alkatrészt leesés ellen.</li> </ul>

	<b>FIGYELEM!</b>
	<p><b>Leeső alkatrészek veszélye a kioldott csavarok miatt!</b> A készülék többi részeinek vagy az ügyfél lakásának (pl. padló) károsodása.</p> <ul style="list-style-type: none"> <li>▶ Biztosítsa az alkatrészt leesés ellen.</li> </ul>

### Követelmény:

- ✔ A készüléket leválasztotta az áramellátásról.
- ✔ Szétválasztotta a bútorajtót és a készülékajtót. Lásd a Beszerelési útmutatót.

### 4.3.1 A csúszózsánér eltávolítása

- ▶ 1. Csavarja ki a két csavart (1).
- ▶ 2. Távolítsa el a felső zsanért (2).
- ▶ 3. Vegye le az ajtót (3).
- ▶ 4. Csavarja ki a két csavart (4).
- ▶ 5. Távolítsa el az alsó zsanért (5).

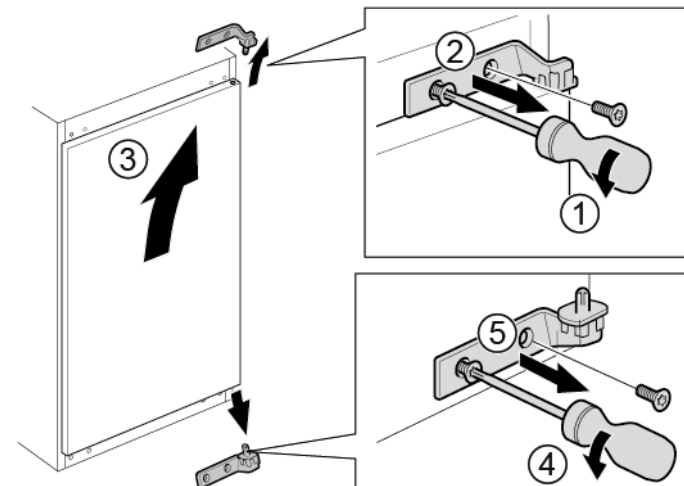

➡ Eltávolította a zsanérokat.

### 4.3.2 A csúszózsánér felszerelése

- ▶ Az elhelyezést fordított sorrendben végezze.



## 4.4 A polc cseréje

### Követelmény:

- ✔ Az ajtó nyitva van

### 4.4.1 A polc eltávolítása

- ▶ Húzza ki a polcot.

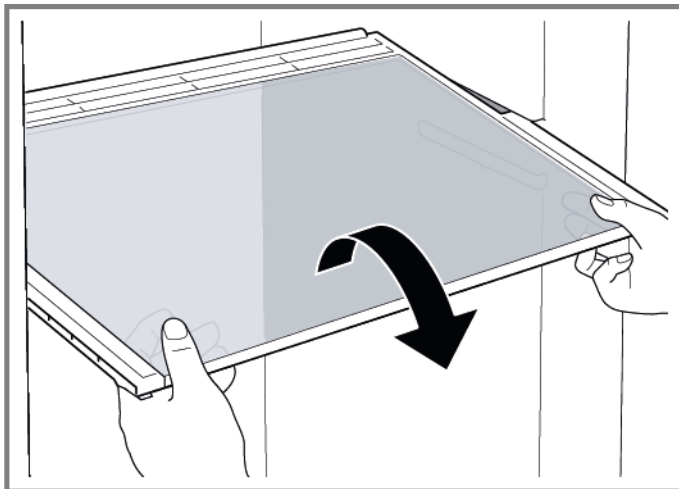

- ➡ Eltávolította a polcot.

### 4.4.2 A polc beszerelése

- ▶ Az elhelyezést fordított sorrendben végezze.

## 4.5 Az ajtópolc cseréje

### Követelmény:

- ✔ Az ajtó nyitva van

### 4.5.1 Az ajtópolc eltávolítása

- ▶ Emelje fel az ajtópolcot.

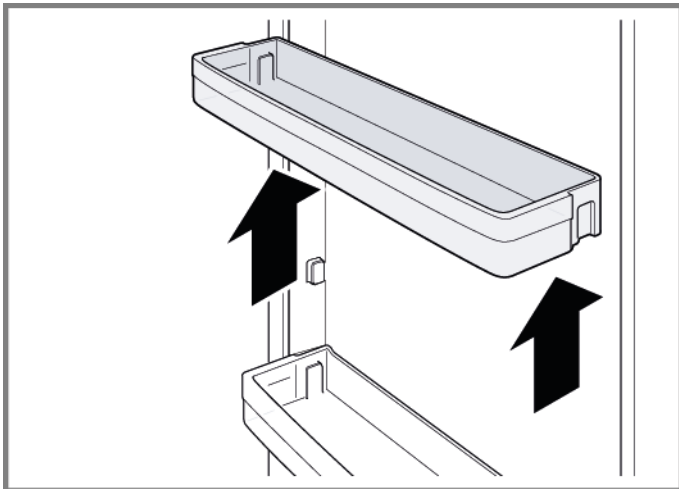

- ➡ Eltávolította az ajtópolcot.

### 4.5.2 Az ajtópolc felhelyezése

- ▶ Az elhelyezést fordított sorrendben végezze.

## 4.6 A gyümölcs- és zöldségtároló cseréje

### Követelmény:

- ✔ Az ajtó nyitva van

### 4.6.1 A gyümölcs- és zöldségtároló eltávolítása

1. Húzza ki a zöldség- és gyümölcstárolót, amennyire csak tudja.
2. 1. Maga felé húzva emelje ki a zöldség- és gyümölcstárolót (1).  
2. Távolítsa el a tárolótartályt (2).

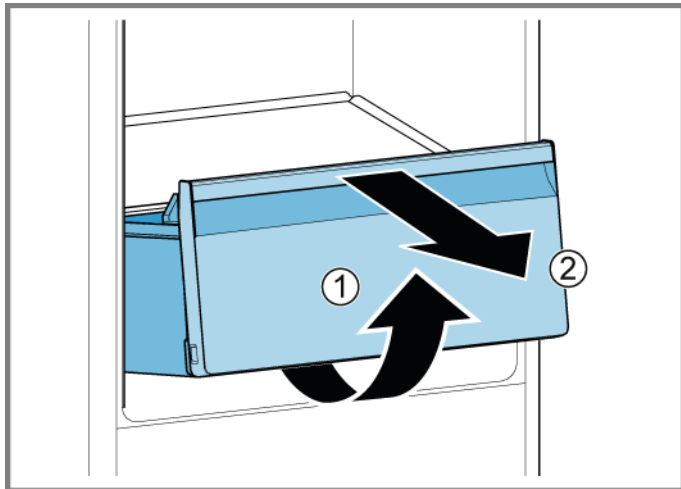

- ➔ Eltávolította a gyümölcs- és zöldségtárolót.

### 4.6.2 A gyümölcs- és zöldségtároló behelyezése

- ▶ Az elhelyezést fordított sorrendben végezze.

## 4.7 A LED-es oldalsó lámpa cseréje

### Különleges eszközök

Tapadókorong Ø50 mm [00342224]

**i** A készüléke karbantartásmentes LED-világítással rendelkezik.  
A világítást kizárólag az ügyfélszolgálat vagy szakképzett technikusok javíthatják meg!

**⚠ VESZÉLY**  
**Áramütés veszélye áram alatt lévő alkatrészek miatt!**  
Életveszély a nem megfelelő javítás okozta áramütés miatt

- ▶ Az elektromos alkatrészek javítását kizárólag képzett elektroműszerész végezheti.
- ▶ A javítás után végeztesen a VDE 0701-nek vagy az országspecifikus szabályozásoknak megfelelő vizsgálatot.

**⚠ VESZÉLY**  
**Áramütés veszélye áram alatt lévő alkatrészek miatt!**  
Halálos áramütés

- ▶ A javítás megkezdése előtt legalább 60 másodperccel válassza le a készülékeket az elektromos hálózatról.

**⚠ VIGYÁZAT**  
**Éles szélek!**  
Vágási sérülések

- ▶ Viseljen védőkesztyűt.

### Követelmény:

- ✓ A készüléket leválasztotta az áramellátásról.
- ✓ Az ajtó nyitva van
- ✓ eltávolította a polcokat.

### 4.7.1 LED-es oldalsó lámpa eltávolítása

1. Nyomja a két tapadókorongot a LED-es oldalsó lámpa burkolatára.

2. Húzza maga felé a tapadókorongokat egyetlen forgó mozdulattal.

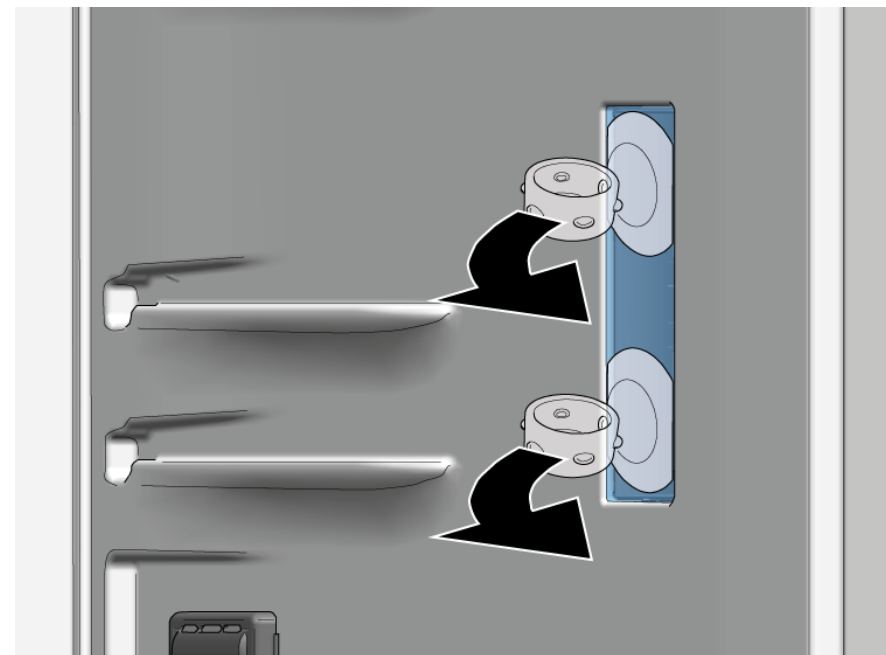

➔ Eltávolította a LED burkolatát.

3. Távolítsa el a LED-es modult.



➡ Eltávolította a LED-es oldalsó lámpát.

## 4.7.2 A LED-es oldalsó lámpa beszerelése



A lámpaburkolat miatt a horgok könnyen eltörhetnek az eltávolítás során. A LED-es oldalsó lámpa pótalkatrésze az a készlet, amely a LED-es modult és a lámpaburkolatot tartalmazza.

- ▶ Az elhelyezést fordított sorrendben végezze.

# Consigli di riparazione - Frigorifero

 <b>Utilizzo del documento</b> .....	<b>195</b>
1.1 Avvertenze importanti .....	195
1.1.1 Scopo .....	195
1.2 Spiegazione dei simboli .....	195
1.2.1 Livelli di pericolo .....	195
1.2.2 Simboli di pericolo .....	195
1.2.3 Struttura degli avvertimenti .....	196
1.2.4 Simboli generici .....	196
 <b>Sicurezza</b> .....	<b>197</b>
2.1 Note generali sulla sicurezza .....	197
2.1.1 Tutti gli elettrodomestici .....	197
 <b>Strumenti e ausili</b> .....	<b>198</b>
 <b>Riparazione</b> .....	<b>199</b>
4.1 Sostituzione della guarnizione della porta .....	199
4.1.1 Smontaggio della guarnizione della porta .....	199
4.1.2 Montaggio della guarnizione della porta .....	199
4.2 Sostituzione della cerniera piatta .....	202
4.2.1 Smontaggio della cerniera piatta .....	202
4.2.2 Montaggio della cerniera piatta .....	203
4.3 Sostituzione della cerniera scorrevole .....	204
4.3.1 Smontaggio della cerniera scorrevole .....	204
4.3.2 Montaggio della cerniera scorrevole .....	204
4.4 Sostituzione del ripiano .....	205
4.4.1 Smontaggio del ripiano .....	205
4.4.2 Montaggio del ripiano .....	205
4.5 Sostituzione del balconcino della porta .....	206
4.5.1 Smontaggio del balconcino della porta .....	206
4.5.2 Montaggio del balconcino della porta .....	206
4.6 Sostituzione del cassetto frutta e verdura .....	207
4.6.1 Rimozione del cassetto frutta e verdura .....	207
4.6.2 Inserimento del cassetto frutta e verdura .....	207
4.7 Sostituzione della luce a LED laterale .....	208
4.7.1 Smontaggio della luce a LED laterale .....	208
4.7.2 Montaggio della luce a LED laterale .....	209

# **i** Utilizzo del documento

## 1.1 Avvertenze importanti

### 1.1.1 Scopo

Queste istruzioni di riparazione spiegano ai clienti come riparare da soli gli elettrodomestici in conformità alle regole sull'Ecodesign vigenti (al 03/2021).

Contengono informazioni sulla sostituzione di pezzi di ricambio specifici e sulle avvertenze e i rischi correlati.

In caso di domande, contattare l'assistenza tecnica. Il mancato rispetto di tali istruzioni da parte dei clienti ci esonera da qualsiasi responsabilità.

## 1.2 Spiegazione dei simboli

### 1.2.1 Livelli di pericolo

I livelli di avvertimento corrispondono a un simbolo accompagnato da una parola di allerta. La parola di allerta identifica il livello di pericolo.





Livello di avvertimento	Significato
	Ignorare questo messaggio di avvertimento comporta rischio di morte o ferite gravi.
	Ignorare questo messaggio di avvertimento può comportare rischio di morte o ferite gravi.
	Ignorare questo messaggio di avvertimento può comportare ferite di minore gravità.
	Ignorare questo messaggio di avvertimento può comportare danni materiali.

Tabella 1: Livelli di pericolo

### 1.2.2 Simboli di pericolo

I simboli di pericolo sono illustrazioni che specificano la tipologia di rischio.

Nella presente documentazione vengono utilizzati i seguenti simboli di pericolo:

Simbolo di pericolo	Significato
	Messaggio di avvertimento generico
	Pericolo di scossa elettrica
	Pericolo di esplosione
	Rischio di ferite da taglio

## Utilizzo del documento





Simbolo di pericolo	Significato
	Pericolo di schiacciamento
	Pericolo derivante da superfici calde
	Pericolo derivante da forti campi magnetici
	Pericolo derivante da radiazioni non ionizzanti

Tabella 2: Simboli di pericolo

### 1.2.3 Struttura degli avvertimenti

Gli avvertimenti presenti in questo manuale hanno una forma e una struttura standardizzati.

	<p> <b>PERICOLO</b></p> <p><b>Tipo e origine del pericolo!</b> Possibili conseguenze in caso di pericolo/avvertimento ignorato.</p> <ul style="list-style-type: none"> <li>▸ Misure e divieti volti a prevenire il pericolo.</li> </ul>
--	--

L'esempio seguente mostra un avvertimento con rischio di folgorazione dovuto a componenti sotto tensione. È riportata la misura di precauzione per evitare il pericolo.

	<p> <b>PERICOLO</b></p> <p><b>Rischio di scossa elettrica dovuto a componenti sotto tensione!</b> Morte per folgorazione</p> <ul style="list-style-type: none"> <li>▸ Scollegare l'apparecchio dall'alimentazione per almeno 60 secondi prima di iniziare la riparazione.</li> </ul>
--	---

### 1.2.4 Simboli generici

Nel presente manuale vengono utilizzati i seguenti simboli generici:





Simbolo generico	Significato
	Identificazione di un suggerimento speciale (testo e/o grafica)
	Identificazione di un suggerimento semplice (solo testo)
	Identificazione di un link per un video tutorial
	Identificazione degli strumenti necessari
	Identificazione delle condizioni preve necessarie
	Identificazione di una condizione (se ..., allora ...)
	Identificazione di un risultato
[Avvio]	Identificazione di un tasto o di un pulsante
[00123456]	Identificazione di un codice articolo
Stato	Identificazione di un testo/finestra visualizzati (sul display dell'apparecchio)

Tabella 3: Simboli generici



## 2.1 Note generali sulla sicurezza

### 2.1.1 Tutti gli elettrodomestici

#### **Rischio di scosse elettriche dovute a componenti sotto tensione!**

- La riparazione non conforme dei componenti elettrici può causare scosse elettriche!
- Scollegare l'apparecchio dall'alimentazione per almeno 60 secondi prima di iniziare il lavoro.
- Ultimata la riparazione, occorre eseguire un test di sicurezza conforme alla norma VDE 0701 o alle norme specifiche del Paese.

#### **Rischio di lesioni causate da bordi taglienti!**

- Indossare guanti di protezione.

#### **Rischio di schiacciamento dovuto a componenti pesanti e in movimento durante la riparazione, la manutenzione, la ricerca dei guasti e l'assistenza**

- Indossare calzature antinfortunistiche.
- Fissare i componenti pesanti per impedire che cadano.
- Non inserire parti del corpo nei componenti in movimento.



#### **Rischio per il funzionamento o la sicurezza dell'apparecchio!**

- Utilizzare solo ricambi originali.

#### **Rischio di danneggiamento di componenti sensibili a carica elettrostatica (ESD)!**

- Non toccare i moduli, inclusi i collegamenti e le piste conduttive.

## Strumenti e ausili

Designazione	Dettagli	Immagini
Panno di protezione [00342013]	60 cm x 50 cm	
Ventosa [00342224]	Ø50 mm	
Punta Torx TX20 [00340865]	6,3 mm (1/4")	

### 4.1 Sostituzione della guarnizione della porta

#### Prerequisiti:

- ✔ La porta è aperta.

#### 4.1.1 Smontaggio della guarnizione della porta

1. Staccare la guarnizione della porta dalla scanalatura negli angoli destro e sinistro.

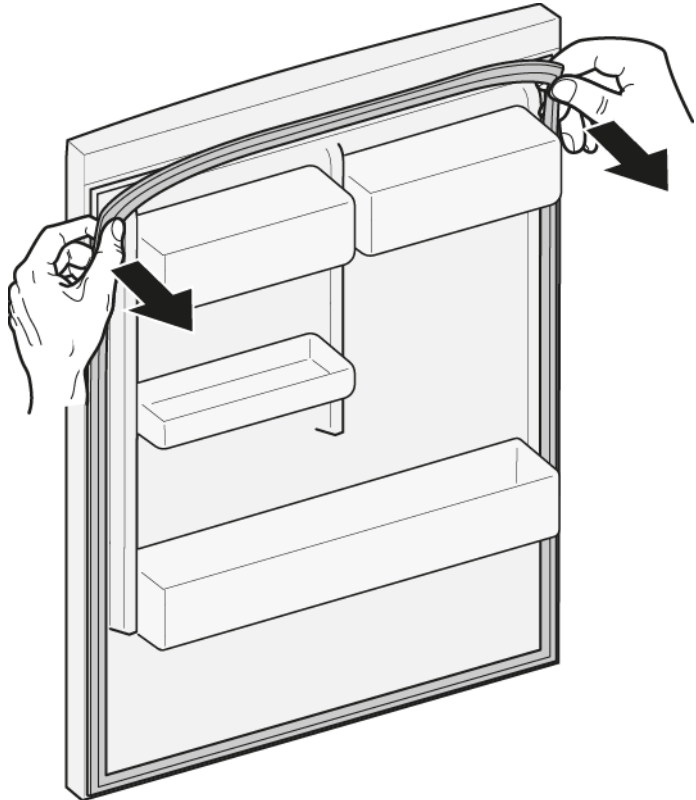

2. Estrarre la guarnizione della porta dalla scanalatura.

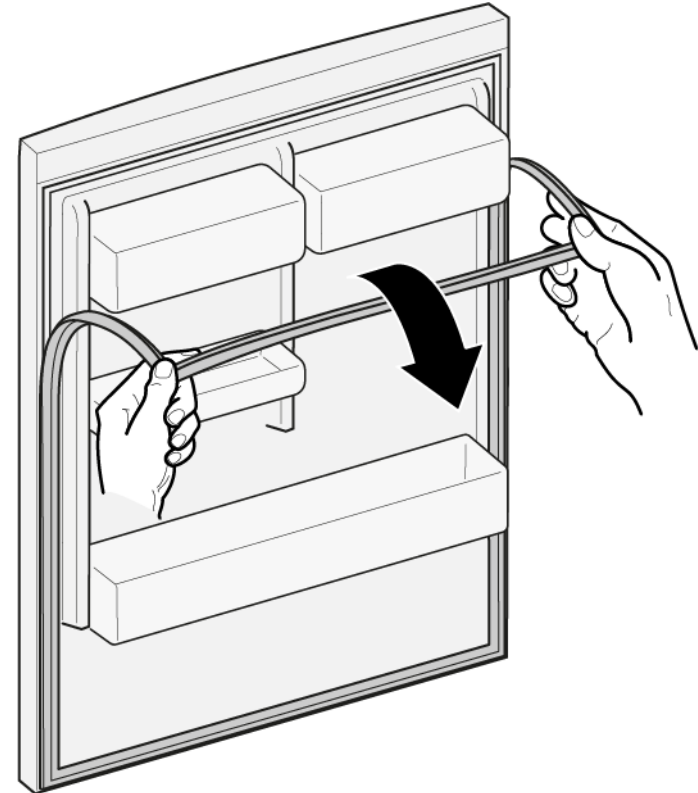

- ➡ La guarnizione della porta è rimossa.

#### 4.1.2 Montaggio della guarnizione della porta



Lo spessore della nuova guarnizione della porta può essere leggermente diverso dallo spessore di quella vecchia. Ciò non incide sulla chiusura e sul funzionamento a lungo termine.

Se l'apparecchio è dotato di cerniere regolabili o accessori, è possibile ottimizzare il comportamento di chiusura.

I piccoli fori laterali nella guarnizione della porta sono funzionali (necessari per la ventilazione). Non si tratta di difetti di produzione.

## Riparazione

1. Controllare che la scanalatura della guarnizione non sia danneggiata.

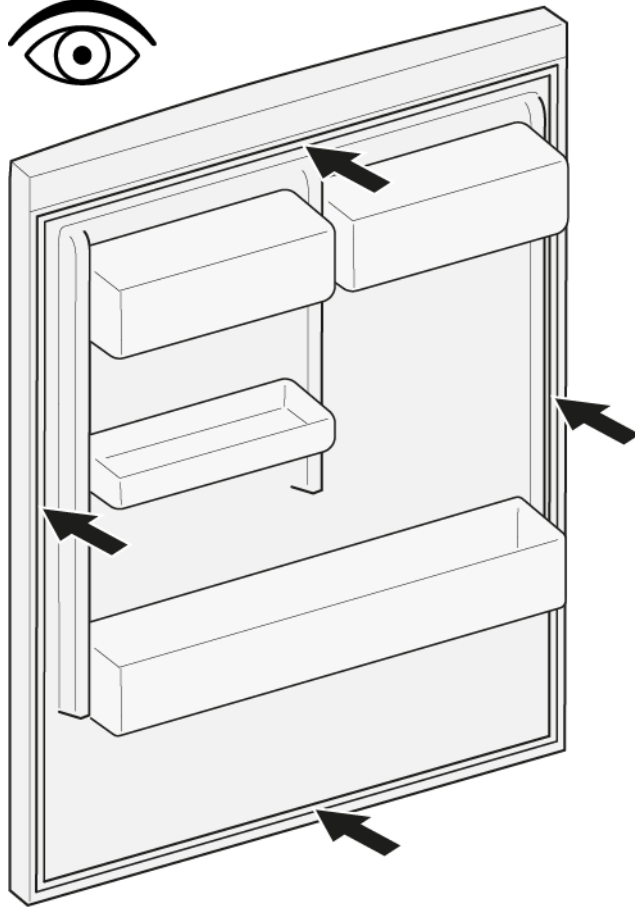

4. Spingere gli angoli della guarnizione nella scanalatura in alto e in basso.

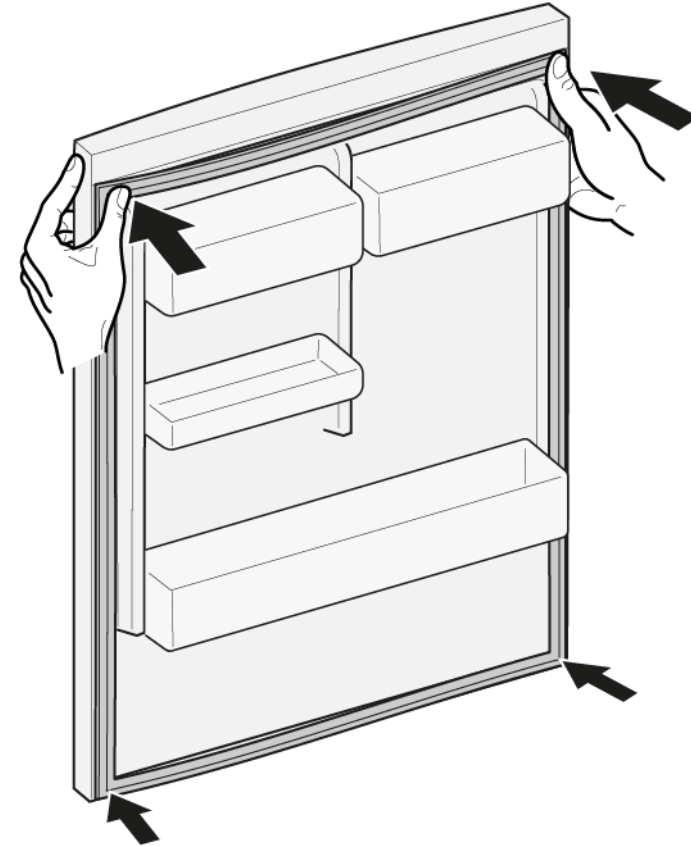

2.  Se la scanalatura della guarnizione è danneggiata.  
- Contattare l'assistenza tecnica.

3. 

	Una leggera deformazione della guarnizione della porta è normale e non incide sul funzionamento. Si consiglia di raddrizzare la guarnizione della porta prima di inserirla nell'apparecchio.
---	--

Riscaldare la guarnizione della porta con un asciugacapelli o acqua calda e ridarle la forma manualmente.

## Riparazione

5. Premere la guarnizione nella scanalatura un pezzo per volta.





-  La guarnizione della porta è montata.

## 4.2 Sostituzione della cerniera piatta

### Attrezzi speciali:

 Punta Torx TX20      6,3 mm (1/4")      [00340865]

	<b>⚠ AVVERTENZA</b>
	<p><b>Apparecchi pesanti, ingombranti!</b>          Rischio di infortuni muscolari e alla schiena</p> <ul style="list-style-type: none"> <li>▶ L'operazione di smontaggio della porta dell'apparecchio deve essere eseguita soltanto da tecnici addestrati.</li> <li>▶ Spostare l'apparecchio in due persone.</li> <li>▶ Usare solo utensili e attrezzature idonei.</li> </ul>



	<b>⚠ ATTENZIONE</b>
	<p><b>Bordi taglienti!</b>          Ferite da taglio</p> <ul style="list-style-type: none"> <li>▶ Indossare guanti di protezione.</li> </ul>

	<b>⚠ ATTENZIONE</b>
	<p><b>Zona della cerniera aperta!</b>          Rischio di schiacciamento delle dita / di rimanere incastrati</p> <ul style="list-style-type: none"> <li>▶ Non inserire le dita nella zona della cerniera.</li> <li>▶ Indossare guanti di protezione.</li> </ul>

	<b>⚠ ATTENZIONE</b>
	<p><b>Rischio di caduta di componenti a causa di viti allentate!</b>          Lesioni provocate dalla caduta di componenti.</p> <ul style="list-style-type: none"> <li>▶ Fissare i componenti in modo che non cadano.</li> </ul>

	<b>ATTENZIONE!</b>
	<p><b>Rischio di caduta di componenti a causa di viti allentate!</b>          Danni a altre parti dell'apparecchio o all'abitazione del cliente, ad es. parte inferiore.</p> <ul style="list-style-type: none"> <li>▶ Fissare i componenti in modo che non cadano.</li> </ul>

### Prerequisiti:

-  L'apparecchio è scollegato dalla rete elettrica.
-  Il pannello della porta è rimosso. Vedere le Istruzioni di installazione.
-  La porta è aperta.

### 4.2.1 Smontaggio della cerniera piatta

Prestare attenzione che le cerniere non si chiudano durante lo smontaggio / rimontaggio.

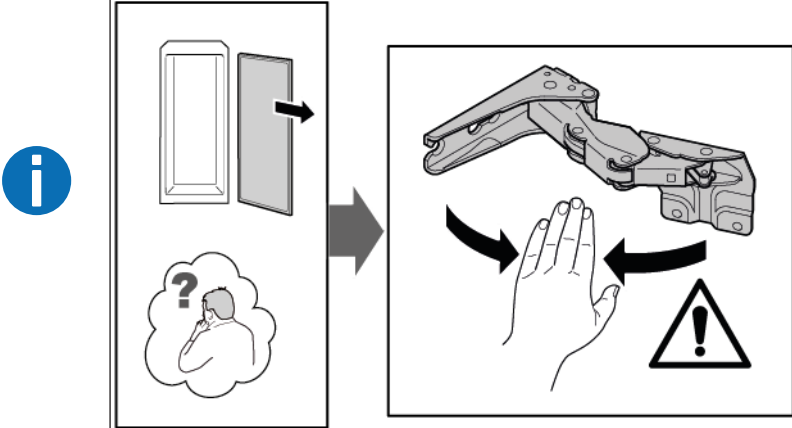

1. Togliere le coperture delle due cerniere.

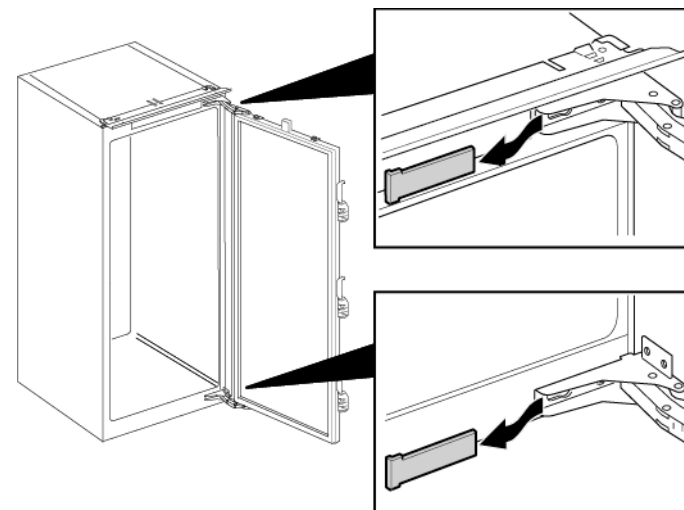



## Riparazione

1. Svitare le quattro viti (1).
2. Far scorrere e rimuovere la porta (2).

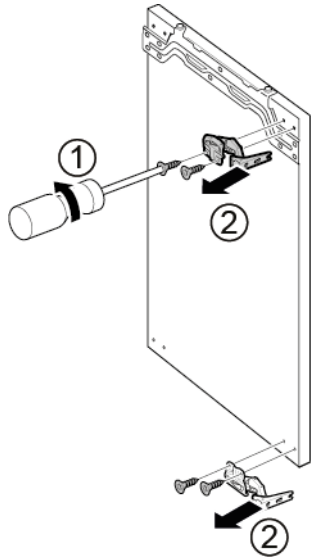

3. 1. Togliere le quattro viti (1).
2. Togliere le cerniere (2).



 Le cerniere sono rimosse.

### 4.2.2 Montaggio della cerniera piatta

- Per il montaggio, seguire la procedura sopra descritta in senso opposto.

## 4.3 Sostituzione della cerniera scorrevole

### Attrezzi speciali:

 Punta Torx TX20      6,3 mm (1/4")      [00340865]

	<b>⚠ AVVERTENZA</b>
	<b>Apparecchi pesanti, ingombranti!</b> Rischio di infortuni muscolari e alla schiena <ul style="list-style-type: none"><li>▶ L'operazione di smontaggio della porta dell'apparecchio deve essere eseguita soltanto da tecnici addestrati.</li><li>▶ Spostare l'apparecchio in due persone.</li><li>▶ Usare solo utensili e attrezzature idonei.</li></ul>

	<b>⚠ ATTENZIONE</b>
	<b>Bordi taglienti!</b> Ferite da taglio <ul style="list-style-type: none"><li>▶ Indossare guanti di protezione.</li></ul>

	<b>⚠ ATTENZIONE</b>
	<b>Rischio di caduta di componenti a causa di viti allentate!</b> Lesioni provocate dalla caduta di componenti. <ul style="list-style-type: none"><li>▶ Fissare i componenti in modo che non cadano.</li></ul>

	<b>ATTENZIONE!</b>
	<b>Rischio di caduta di componenti a causa di viti allentate!</b> Danni a altre parti dell'apparecchio o all'abitazione del cliente, ad es. parte inferiore. <ul style="list-style-type: none"><li>▶ Fissare i componenti in modo che non cadano.</li></ul>

### Prerequisiti:

- ✔ L'apparecchio è scollegato dalla rete elettrica.
- ✔ Il pannello della porta e la porta dell'apparecchio sono separate. Vedere le Istruzioni di installazione.

### 4.3.1 Smontaggio della cerniera scorrevole

- ▶ 1. Svitare le due viti (1).
- ▶ 2. Togliere la cerniera superiore (2).
- ▶ 3. Togliere la porta (3).
- ▶ 4. Svitare le due viti (4).
- ▶ 5. Togliere la cerniera inferiore (5).

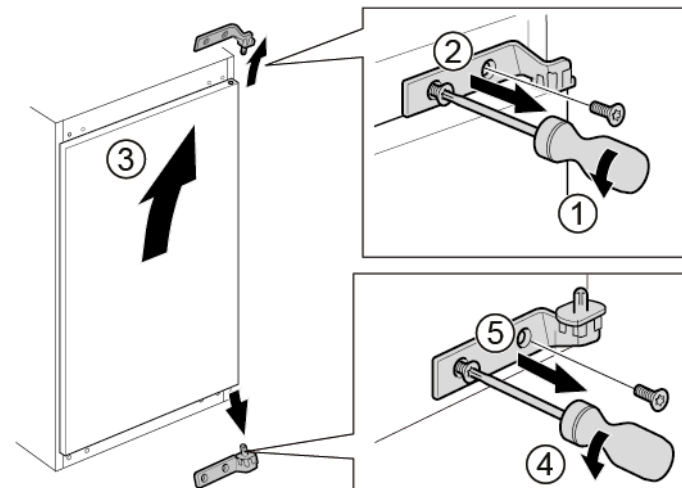

➡ Le cerniere sono rimosse.

### 4.3.2 Montaggio della cerniera scorrevole

- ▶ Per il montaggio, seguire la procedura sopra descritta in senso opposto.



## 4.4 Sostituzione del ripiano

### Prerequisiti:

- ✔ La porta è aperta.

### 4.4.1 Smontaggio del ripiano

- ▶ Estrarre il ripiano.



➡ Il ripiano è rimosso.

### 4.4.2 Montaggio del ripiano

- ▶ Per il montaggio, seguire la procedura sopra descritta in senso opposto.

## 4.5 Sostituzione del balconcino della porta

### Prerequisiti:

- ✔ La porta è aperta.

### 4.5.1 Smontaggio del balconcino della porta

- ▶ Tirare il balconcino della porta verso l'alto.

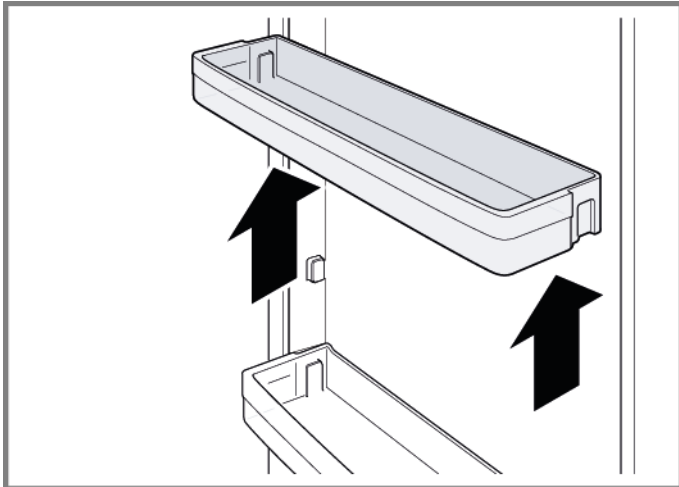

➡ Il balconcino della porta è rimosso.

### 4.5.2 Montaggio del balconcino della porta

- ▶ Per il montaggio, seguire la procedura sopra descritta in senso opposto.

## 4.6 Sostituzione del cassetto frutta e verdura

### Prerequisiti:

- ✔ La porta è aperta.

### 4.6.1 Rimozione del cassetto frutta e verdura

1. Estrarre il cassetto frutta e verdura il più possibile.
2. 1. Sollevare il cassetto frutta e verdura dalla parte anteriore (1).  
2. Rimuovere il cassetto (2).



- ➡ Il cassetto frutta e verdura è rimosso.

### 4.6.2 Inserimento del cassetto frutta e verdura

- ▶ Per il montaggio, seguire la procedura sopra descritta in senso opposto.

## 4.7 Sostituzione della luce a LED laterale

### Attrezzi speciali:

 Ventosa Ø50 mm [00342224]



L'apparecchio è dotato di una luce a LED esente da manutenzione.  
Queste luci possono essere riparate esclusivamente dall'assistenza clienti o da tecnici autorizzati!



### PERICOLO

**Rischio di scosse elettriche dovute a componenti sotto tensione!**  
Pericolo di morte dovuto a scosse elettriche in caso di riparazione non conforme

- ▶ Le parti elettriche devono essere riparate da elettricisti qualificati.
- ▶ Ultimata la riparazione, occorre eseguire un test di sicurezza conforme alla norma VDE 0701 o alle norme specifiche del Paese.



### PERICOLO

**Rischio di scossa elettrica dovuto a componenti sotto tensione!**  
Morte per folgorazione

- ▶ Scollegare l'apparecchio dall'alimentazione per almeno 60 secondi prima di iniziare la riparazione.





### ATTENZIONE

**Bordi taglienti!**

Ferite da taglio

- ▶ Indossare guanti di protezione.

### Prerequisiti:

-  L'apparecchio è scollegato dalla rete elettrica.
-  La porta è aperta.
-  I ripiani sono rimossi.

### 4.7.1 Smontaggio della luce a LED laterale

1. Fissare due ventose al coperchio della luce a LED laterale.

2. Tirare le ventose in avanti con un unico movimento rotatorio.

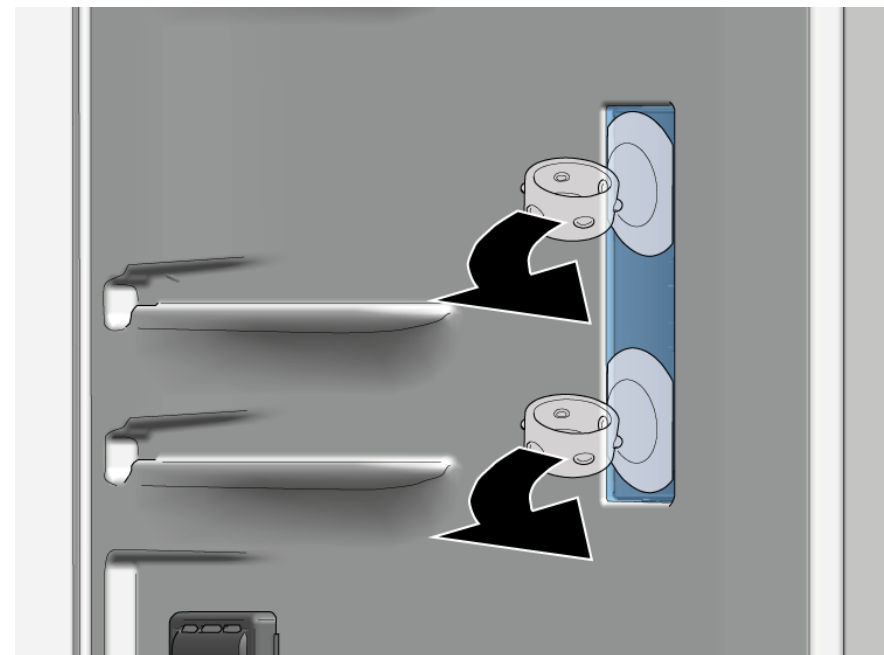

-  Il coperchio della luce a LED è rimosso.

3. Togliere il modulo LED.



 La luce a LED laterale è rimossa.

### 4.7.2 Montaggio della luce a LED laterale



Poiché i fermi del coperchio della luce si rompono facilmente durante lo smontaggio, il ricambio della luce a LED comprende il modulo a LED e il relativo coperchio.

► Per il montaggio, seguire la procedura sopra descritta in senso opposto.

# Informācija par remontu - Ledusskapis

 <b>Par šo dokumentu</b> .....	<b>211</b>
1.1 Būtiska informācija .....	211
1.1.1 Mērķis .....	211
1.2 Simbolu skaidrojums.....	211
1.2.1 Bīstamības līmeņi .....	211
1.2.2 Bīstamības simboli .....	211
1.2.3 Brīdinājumu struktūra .....	212
1.2.4 Vispārīgie simboli.....	212
 <b>Drošība</b> .....	<b>213</b>
2.1 Vispārējie drošības norādījumi .....	213
2.1.1 Visām mājssaimniecības ierīcēm .....	213
 <b>Piederumi un palīgīdzekļi</b> .....	<b>214</b>
 <b>Remonts</b> .....	<b>215</b>
4.1 Durvju blīvslēga nomaiņa .....	215
4.1.1 Durvju blīvslēga noņemšana .....	215
4.1.2 Durvju blīvslēga uzstādīšana .....	215
4.2 Plakanās viras nomaiņa .....	218
4.2.1 Plakanās viras noņemšana .....	218
4.2.2 Plakanās viras uzstādīšana .....	219
4.3 Slīdošās viras nomaiņa .....	220
4.3.1 Slīdošās viras noņemšana .....	220
4.3.2 Slīdošās viras uzstādīšana .....	220
4.4 Plaukta nomaiņa.....	221
4.4.1 Plaukta izņemšana .....	221
4.4.2 Plaukta uzstādīšana .....	221
4.5 Durvju plaukta nomaiņa .....	222
4.5.1 Durvju plaukta noņemšana .....	222
4.5.2 Durvju plaukta uzstādīšana.....	222
4.6 Augļu un dārzeņu tvertnes nomaiņa.....	223
4.6.1 Augļu un dārzeņu tvertnes izņemšana .....	223
4.6.2 Augļu un dārzeņu tvertnes uzstādīšana .....	223
4.7 Sānu LED gaismekļa nomaiņa .....	224
4.7.1 Sānu LED gaismekļa noņemšana .....	224
4.7.2 Sānu LED gaismekļa uzstādīšana.....	225

# **i** Par šo dokumentu

## 1.1 Būtiska informācija

### 1.1.1 Mērķis

Šie labošanas ieteikumi ir paredzēti patērētājam, lai patstāvīgi labotu ierīces, saskaņā ar piemērojamo Ekodizaina regulu (sākot no 03.2021.).



Ir sniegta informācija, kā nomainīt noteiktas rezerves daļas, un brīdinājumi, kā arī ir aprakstīti riski.

Ja ir jautājumi, sazinieties ar mūsu klientu apkalpošanas dienestu. Mēs atbildam par zaudējumiem tikai tad, ja šie labošanas ieteikumi ir pienācīgi ievēroti.

## 1.2 Simbolu skaidrojums

### 1.2.1 Bīstamības līmeņi

Brīdinājuma līmeņus veido simbols un signālvārds. Signālvārds apzīmē bīstamības pakāpi.





Brīdinājuma līmenis	Nozīme
 <b>BĪSTAMI</b>	Brīdinājuma paziņojuma neievērošanas rezultātā iestāsies nāve vai radīsies smagas traumas.
 <b>BRĪDINĀJUMS</b>	Brīdinājuma paziņojuma neievērošanas rezultātā var iestāties nāve vai rasties smagas traumas.
 <b>ESJET PIESARDŽĪGI</b>	Brīdinājuma paziņojuma neievērošanas rezultātā var rasties nelielas traumas.
 <b>UZMANĪBU!</b>	Brīdinājuma paziņojuma neievērošanas rezultātā var rasties kaitējums īpašumam.

Tabula 1: Bīstamības līmeņi



### 1.2.2 Bīstamības simboli

Bīstamības simboli ir simboliski apzīmējumi, kas sniedz norādes par bīstamības veidu.

Šajā dokumentā ir izmantoti šādi bīstamības simboli:

Bīstamības simbols	Nozīme
	Vispārējs brīdinājuma paziņojums
	Elektriskā sprieguma radīts apdraudējums
	Sprādzienbīstamības risks
	Griezumu bīstamība
	Saspiešanas bīstamība

## **i** Par šo dokumentu

Bīstamības simbols	Nozīme
	Karstu virsmu radīta bīstamība
	Spēcīgu magnētisko lauku radīta bīstamība
	Nejonizējoša starojuma radīta bīstamība

Tabula 2: Bīstamības simboli

### 1.2.3 Brīdinājumu struktūra

Šajā dokumentā sniegtajiem brīdinājumiem ir standartizēts noformējums un standartizēta struktūra.



	<p><b>⚠ BĪSTAMI</b></p> <p><b>Bīstamības veids un avots!</b> Iespējamās sekas, kas rodas, neievērojot bīstamības paziņojumu / brīdinājumu.</p> <ul style="list-style-type: none"> <li>▶ Bīstamības novēršanas pasākumi un aizliegumi.</li> </ul>
--	--





Nākamajā piemērā ir parādīts brīdinājums, kas apzīmē elektrotrieciena risku, ko rada spriegumaktīvas detaļas. Ir norādīts bīstamības novēršanas pasākums.

	<p><b>⚠ BĪSTAMI</b></p> <p><b>Elektrotrieciena risks, ko rada spriegumaktīvas detaļas!</b> Nāvējošs elektrotrieciens</p> <ul style="list-style-type: none"> <li>▶ Atvienojiet iekārtas no strāvas padeves vismaz 60 sekundes pirms labošanas sākšanas.</li> </ul>
--	---

### 1.2.4 Vispārīgie simboli

Šajā dokumentā ir izmantoti šādi vispārīgie simboli:

Visp. simbols	Nozīme
	Īpašu ieteikumu apzīmējums (teksts un/ vai grafika)
	Vienkāršu ieteikumu apzīmējums (tikai teksts)

Visp. simbols	Nozīme
	Video pamācības saites apzīmējums
	Nepieciešamo rīku apzīmējums
	Nepieciešamo priekšnosacījumu apzīmējums
	Nosacījuma apzīmējums (ja ..., tad ...)
	Rezultāta apzīmējums
[Sākt]	Taustiņa vai pogas apzīmējums
[00123456]	Materiāla numura apzīmējums
Statuss	Attēlotā teksta / loga apzīmējums (iekārtas displejā)

Tabula 3: Vispārīgie simboli



## 2.1 Vispārējie drošības norādījumi

### 2.1.1 Visām mājsaimniecības ierīcēm

#### **Elektrotrieciena risks spriegumaktīvu daļu dēļ!**

- Ja remonts, kas skar elektriskās daļas, ir veikts kļūdaini, pastāv elektrotrieciena risks!
- Ierīcei ir jābūt atvienotai no tīkla vismaz 60 sekundes, pirms sāk darbu.
- Pēc remonta ierīces drošība ir jāpārbauda atbilstīgi noteikumiem VDE 0701 vai valsts noteikumiem.

#### **Savainojumu risks asu malu dēļ!**

- Valkājiet aizsargcimdus.

#### **Saspiešanas risks labošanas, uzturēšanas, traucējumu novēršanas un apkopes laikā, ko rada smagas un kustīgas detaļas**

- Valkājiet aizsargapavus.
- Nostipriniet smagas detaļas, lai tās nenokristu.
- Neievietojiet ķermeņa daļas kustīgās detaļās.



#### **Ierīces drošības / darbības traucējuma risks!**

- Izmantojiet tikai oriģinālās rezerves daļas.

#### **Pret elektrostatisko izlādi jutīgu daļu (ESDS) bojājuma risks!**

- Neaiztieciet moduļus, ieskaitot savienojumus un vadojumu.

## Piederumi un palīglīdzekļi

Apzīmējums	Sīkāka informācija	Attēli
Aizsargdrāna [00342013]	60 cm x 50 cm	
Piesūceknis [00342224]	Ø50 mm	
Torx uzgalis TX20 [00340865]	6,3 mm (1/4")	

## 4.1 Durvju blīvslēga nomaīņa

### Prasība:

- ✓ Durvīm ir jābūt atvērtām.

### 4.1.1 Durvju blīvslēga noņemšana

1. Atbrīvojiet durvju blīvslēgu no rievas labajā un kreisajā pusē.



2. Izvelciet durvju blīvslēgu no rievas.



- ➡ Durvju blīvslēgs ir noņemts.

### 4.1.2 Durvju blīvslēga uzstādīšana





Jaunā durvju blīvslēga biezums var mazliet atšķirties no vecā durvju blīvslēga biezuma. Tas neietekmē aizvēršanos un darbību ilgtermiņā. Ja ierīces viras var regulēt vai tai ir viru savienojumi, vēlāk aizvēršanos var pielāgot. Mazie caurumi durvju blīvslēga sānos ir funkcionāli (nodrošina ventilāciju). Tie nav ražošanas defekti.

1. Pārbaudiet, ka blīvslēga rieva nav bojāta.

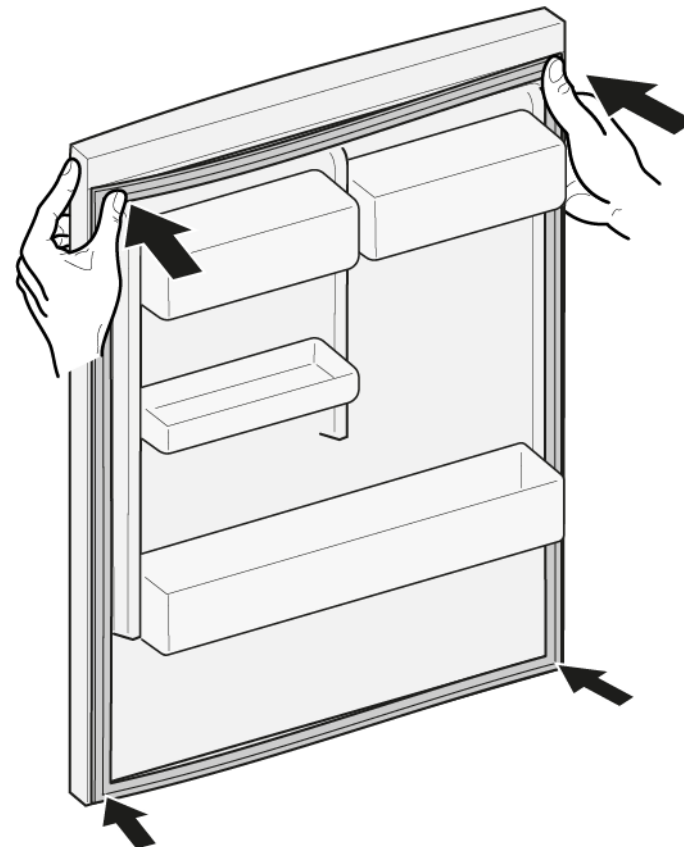

4. Iespiediet blīvslēga augšējos un apakšējos stūrus riņķī.



2.  Ja blīvslēga rieva ir bojāta  
- Sazinieties ar klientu apkalpošanas dienesta pārstāvi.

3.  Durvju blīvslēgs var būt mazliet deformējies, kas neietekmē tā darbību. Pirms durvju blīvslēgu ieliek ierīcē, to ir ieteicams iztaisnot.

Sasildiet durvju blīvslēgu ar matu fēnu vai karstā ūdenī un ar rokām atjaunojiet tā formu.

5. Pakāpeniski iespiediet visu blīvslēgu rievā.



 Durvju blīvslēgs ir uzstādīts.

## 4.2 Plakanās viras nomaiņa

### Speciāli rīki:

Torx uzgalis TX20

6,3 mm (1/4")

[00340865]

	<b>BRĪDINĀJUMS</b>
	<p><b>Smaga lielizmēra ierīce!</b> Muguras un muskuļu savainojumi</p> <ul style="list-style-type: none"> <li>▶ Ierīces durvis drīkst noņemt tikai apmācīts speciālists.</li> <li>▶ Ierīce ir jāpārvieta divatā.</li> <li>▶ Ir jāizmanto tikai piemēroti darbarīki un aprīkojums.</li> </ul>

	<b>ESIET PIESARDZĪGI</b>
	<p><b>Asas malas!</b> Grieztas brūces</p> <ul style="list-style-type: none"> <li>▶ Lietojiet aizsargcimdus.</li> </ul>

	<b>ESIET PIESARDZĪGI</b>
	<p><b>Atveriet eņģu nodalījumu!</b> Pirkstu saspiešana / iesprūšana</p> <ul style="list-style-type: none"> <li>▶ Neievietojiet rokas eņģu nodalījumā.</li> <li>▶ Valkājiet aizsargcimdus.</li> </ul>

	<b>ESIET PIESARDZĪGI</b>
	<p><b>Krītošu detaļu risks, ko izraisa vaļīgas skrūves!</b> Krītošu detaļu izraisītas traumas.</p> <ul style="list-style-type: none"> <li>▶ Nostipriniet detaļu, lai tā nenokristu.</li> </ul>

	<b>UZMANĪBU!</b>
	<p><b>Krītošu detaļu risks, ko izraisa vaļīgas skrūves!</b> Citu ierīces detaļu bojājumi vai bojājumi, kas rodas klienta mājās, piem., apakšpuse.</p> <ul style="list-style-type: none"> <li>▶ Nostipriniet detaļu, lai tā nenokristu.</li> </ul>

### Prasība:

- ✔ Ierīces elektropadevei ir jābūt atvienotai.
- ✔ Mēbeles durvīm ir jābūt noņemtām. Skatiet uzstādīšanas instrukciju.
- ✔ Durvīm ir jābūt atvērtām.

## 4.2.1 Plakanās viras noņemšana

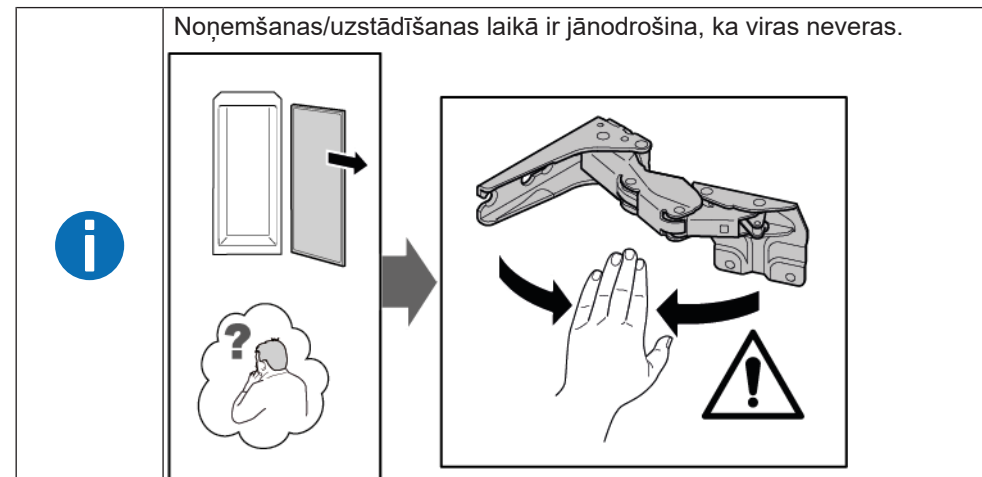

1. Noņemiet abus viras pārseģus.

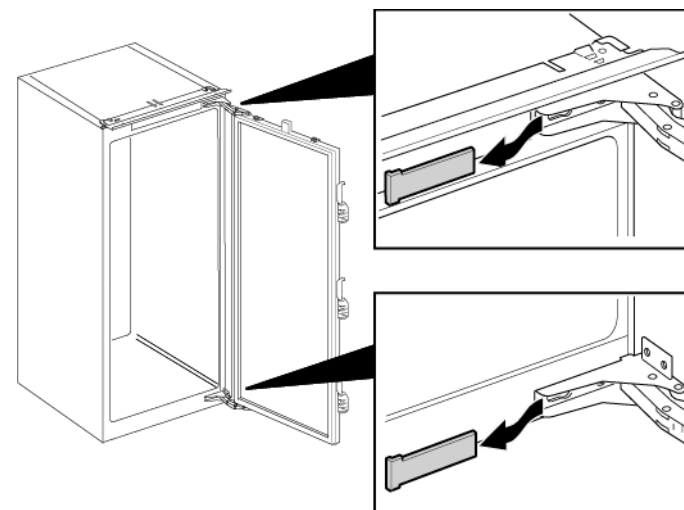

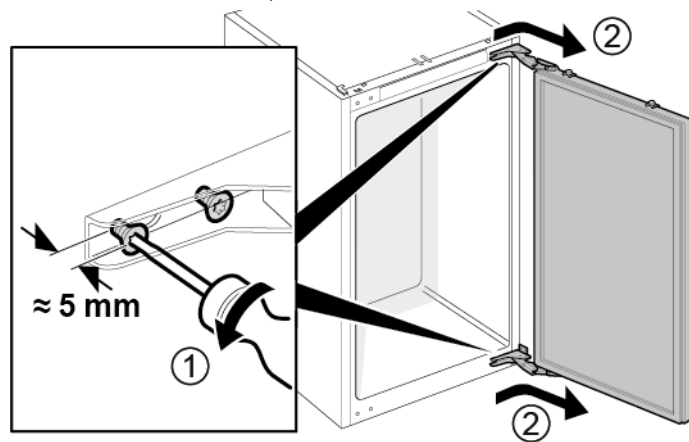

## Remonts

2. 1. Atskrūvējiet četras skrūves (1).
2. Durvis izvelciet un noņemiet (2).

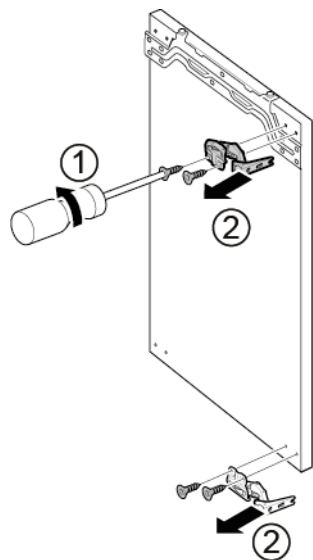

3. 1. Izskrūvējiet četras skrūves (1).
2. Noņemiet viras (2).



 Viras ir noņemtas.

### 4.2.2 Plakanās viras uzstādīšana

- ▶ Uzstādiet apgrieztā kārtībā.

## 4.3 Slīdošās viras nomaiņa

### Speciāli rīki:

Torx uzgalis TX20 6,3 mm (1/4") [00340865]

	<b>BRĪDINĀJUMS</b>
	<p><b>Smaga lielmēra ierīce!</b> Muguras un muskuļu savainojumi</p> <ul style="list-style-type: none"> <li>▶ Ierīces durvis drīkst noņemt tikai apmācīts speciālists.</li> <li>▶ Ierīce ir jāpārvieta divatā.</li> <li>▶ Ir jāizmanto tikai piemēroti darbarīki un aprīkojums.</li> </ul>

	<b>ESIET PIESARDZĪGI</b>
	<p><b>Asas malas!</b> Grieztas brūces</p> <ul style="list-style-type: none"> <li>▶ Lietojiet aizsargcimdus.</li> </ul>

	<b>ESIET PIESARDZĪGI</b>
	<p><b>Krītošu detaļu risks, ko izraisa vaļīgās skrūves!</b> Krītošu detaļu izraisītas traumas.</p> <ul style="list-style-type: none"> <li>▶ Nostipriniet detaļu, lai tā nenokristu.</li> </ul>

	<b>UZMANĪBU!</b>
	<p><b>Krītošu detaļu risks, ko izraisa vaļīgās skrūves!</b> Citu ierīces detaļu bojājumi vai bojājumi, kas rodas klienta mājās, piem., apakšpuse.</p> <ul style="list-style-type: none"> <li>▶ Nostipriniet detaļu, lai tā nenokristu.</li> </ul>

### Prasība:

- ✓ Ierīces elektropadevei ir jābūt atvienotai.
- ✓ Mēbeles durvis un ierīces durvis ir atvienotas. Skatiet uzstādīšanas instrukciju.

### 4.3.1 Slīdošās viras noņemšana

- ▶ 1. Izskrūvējiet abas skrūves (1).
- ▶ 2. Noņemiet augšējo viru (2).
- ▶ 3. Noņemiet durvis (3).
- ▶ 4. Izskrūvējiet abas skrūves (4).
- ▶ 5. Noņemiet apakšējo viru (5).

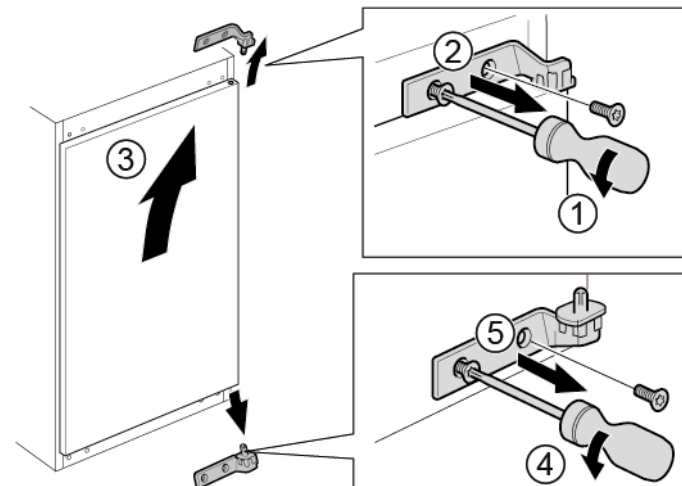

➔ Viras ir noņemtas.

### 4.3.2 Slīdošās viras uzstādīšana

- ▶ Uzstādiet apgrieztā kārtībā.



## 4.4 Plaukta nomaiņa

### Prasība:

- ✔ Durvīm ir jābūt atvērtām.

### 4.4.1 Plaukta izņemšana

- ▶ Izvelciet plauktu.

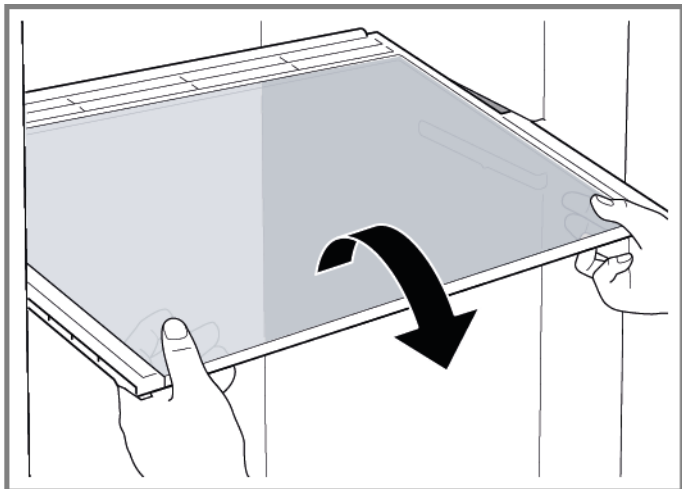

- ➡ Plaukts ir izņemts.

### 4.4.2 Plaukta uzstādīšana

- ▶ Uzstādiet apgrieztā kārtībā.

## 4.5 Durvju plaukta nomaiņa

### Prasība:

- ✓ Durvīm ir jābūt atvērtām.

### 4.5.1 Durvju plaukta noņemšana

- ▶ Paceliet durvju plauktu uz augšu.

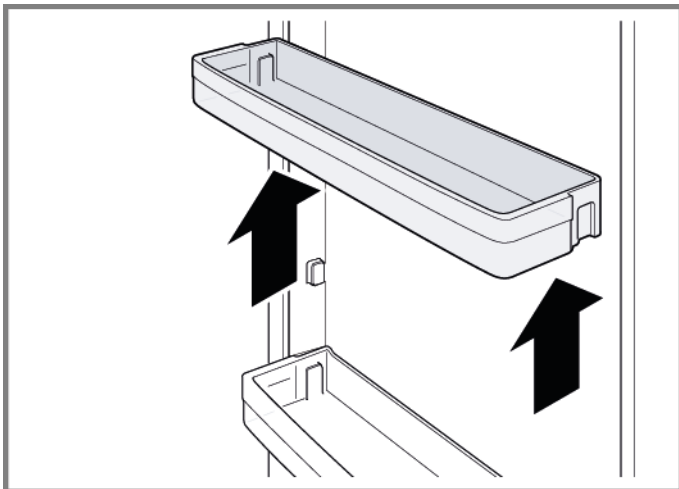

- ➡ Durvju plaukts ir noņemts.

### 4.5.2 Durvju plaukta uzstādīšana

- ▶ Uzstādiet apgrieztā kārtībā.

## 4.6 Augļu un dārzeņu tvertnes nomaiņa

### Prasība:

- ✔ Durvīm ir jābūt atvērtām.

### 4.6.1 Augļu un dārzeņu tvertnes izņemšana

1. Izvelciet augļu un dārzeņu tvertni līdz atdurei.
2. 1. Paceliet augļu un dārzeņu tvertni priekšā (1).  
2. Izņemiet tvertni (2).

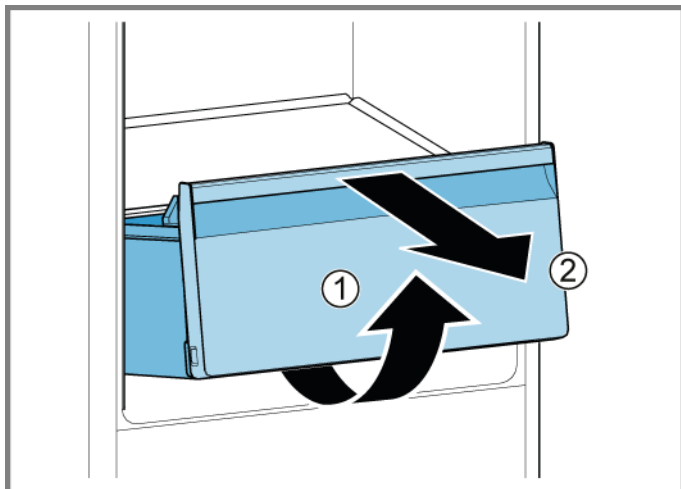

- ➔ Augļu un dārzeņu tvertne ir izņemta.

### 4.6.2 Augļu un dārzeņu tvertnes uzstādīšana

- ▶ Uzstādiet apgrieztā kārtībā.

## 4.7 Sānu LED gaismekļa nomaīņa

### Speciāli rīki:

Piesūceknis Ø50 mm [00342224]

**i** Ierīcē ir LED gaismeklis, kam nav jāveic apkope.  
Šo gaismekli drīkst remontēt tikai klientu apkalpošanas dienesta pārstāvis vai pilnvarots tehniķis!

**⚠ BĪSTAMI**  
**Elektrotrieciena risks spriegumaktīvu daļu dēļ!**  
Dzīvības apdraudējums nepareiza remonta izraisīta elektrotrieciena dēļ

- ▶ Elektriskās daļas ir jāremontē kvalificētam elektriķim.
- ▶ Pēc remonta ierīces drošība ir jāpārbauda atbilstīgi noteikumiem VDE 0701 vai valsts noteikumiem.

**⚠ BĪSTAMI**  
**Elektrotrieciena risks, ko rada spriegumaktīvas detaļas!**  
Nāvējošs elektrotrieciens

- ▶ Atvienojiet iekārtas no strāvas padeves vismaz 60 sekundes pirms labošanas sākšanas.

**⚠ ESIET PIESARDZĪGI**  
**Asas malas!**  
Griezta brūces

- ▶ Lietojiet aizsargcimdus.

### Prasība:

- ✓ Ierīces elektropadevei ir jābūt atvienotai.
- ✓ Durvīm ir jābūt atvērtām.
- ✓ Plauktiem ir jābūt izņemtiem.

### 4.7.1 Sānu LED gaismekļa noņemšana

1. Uzspiediet divus piesūcekņus uz sānu LED gaismekļa pārsega.

2. Piesūcekņus pagriežot pavelciet uz priekšu.

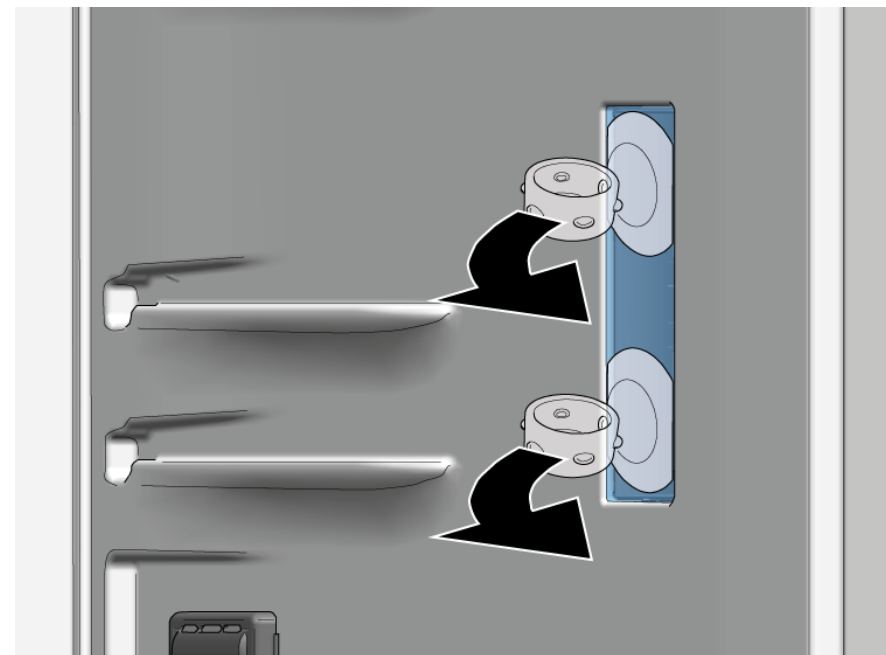

➡ LED gaismekļa pārsegs ir noņemts.

3. Noņemiet LED moduli.

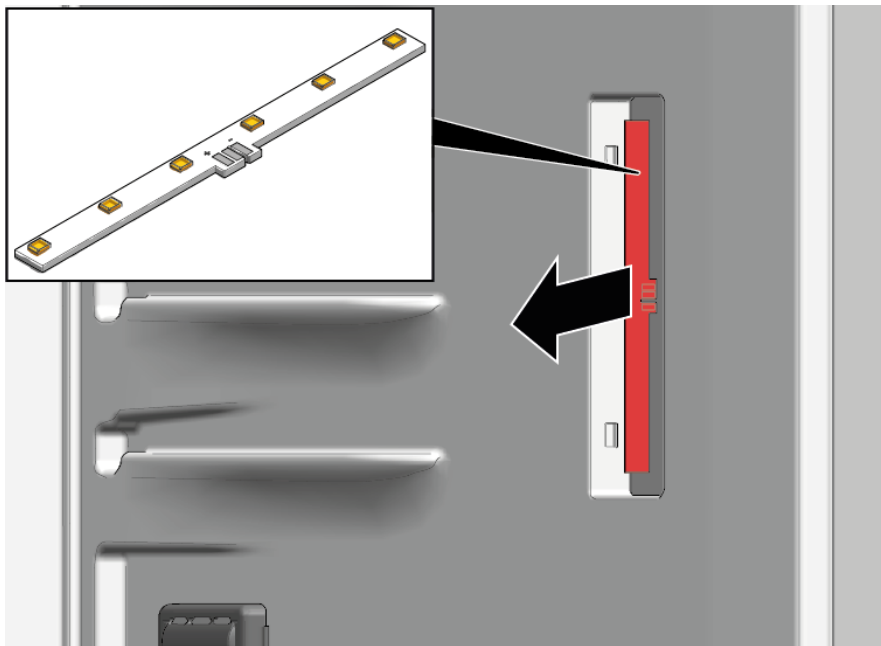

 Sānu LED gaismeklis ir noņemts.





### 4.7.2 Sānu LED gaismekļa uzstādīšana



Noņemšanas laikā var viegli salauzt gaismekļa pārsega āķus, tāpēc LED sānu gaismekļa rezerves daļas komplektā ir iekļauts LED modulis un gaismekļa pārsegs.

- ▶ Uzstādiet apgrieztā kārtībā.

# Informacija apie remontą - Šaldytuvas

 <b>Dėl šio dokumento</b> .....	<b>227</b>
1.1 Svarbi informacija .....	227
1.1.1 Paskirtis .....	227
1.2 Simbolių paaiškinimas .....	227
1.2.1 Pavojaus lygiai.....	227
1.2.2 Pavojaus simboliai .....	227
1.2.3 Įspėjimų struktūra.....	228
1.2.4 Bendrieji simboliai .....	228
 <b>Sauga</b> .....	<b>229</b>
2.1 Bendrosios saugos instrukcijos.....	229
2.1.1 Visi buitiniai prietaisai .....	229
 <b>Įrankiai ir pagalbinės priemonės</b> .....	<b>230</b>
 <b>Remontas</b> .....	<b>231</b>
4.1 Durelių tarpiklio keitimas .....	231
4.1.1 Durelių tarpiklio išėmimas.....	231
4.1.2 Durelių tarpiklio įdėjimas.....	231
4.2 Atlenkiamo vyro keitimas.....	234
4.2.1 Atlenkiamo vyro nuėmimas .....	234
4.2.2 Atlenkiamo vyro montavimas .....	235
4.3 Slankiojo vyro keitimas.....	236
4.3.1 Slankiojo vyro nuėmimas .....	236
4.3.2 Slankiojo vyro montavimas .....	236
4.4 Lentynos keitimas.....	237
4.4.1 Lentynos nuėmimas .....	237
4.4.2 Lentynos įdėjimas .....	237
4.5 Durelių lentynos keitimas .....	238
4.5.1 Durelių lentynos išėmimas.....	238
4.5.2 Durelių lentynos įdėjimas.....	238
4.6 Vaisių ir daržovių talpyklos keitimas.....	239
4.6.1 Vaisių ir daržovių talpyklos išėmimas .....	239
4.6.2 Vaisių ir daržovių talpyklos įdėjimas .....	239
4.7 Šoninės LED lemputės keitimas .....	240
4.7.1 Šoninės LED lemputės išėmimas.....	240
4.7.2 Šoninės LED lemputės montavimas .....	241

# **i** Dėl šio dokumento

## 1.1 Svarbi informacija

### 1.1.1 Paskirtis

Šios remonto nuorodos padeda naudotojui pataisyti prietaisus patiems pagal galiojantį ekologinio projektavimo reglamentą (2021 m. kovo mėn. redakcija).



Jose pateikta informacija, kaip pakeisti tam tikras atsargines dalis, įskaitant ir įspėjimus bei riziką.

Jei kiltų klausimų, kreipkitės į mūsų klientų aptarnavimo tarnybą. Mes atsakysime už žalą tik tuo atveju, jei bus tinkamai laikomasi remonto nuorodų.

## 1.2 Simbolių paaiškinimas

### 1.2.1 Pavojaus lygiai

Įspėjimo lygiai susideda iš simbolio ir signalinio žodžio. Signalinis žodis nurodo pavojaus sunkumą.





Įspėjimo lygis	Reikšmė
 <b>PAVOJUS</b>	Nepaisant įspėjamojo pranešimo, ištinka mirtis arba sunkūs sužalojimai.
 <b>ĮSPĖJIMAS</b>	Nepaisant įspėjamojo pranešimo, gali ištikti mirtis arba sunkūs sužalojimai.
 <b>PERSPĖJIMAS</b>	Nepaisant įspėjamojo pranešimo, galimi nedideli sužalojimai.
<b>DĖMESIO!</b>	Nepaisant įspėjamojo pranešimo, gali būti sugadintas turtas.

Lentelė 1: Pavojaus lygiai



### 1.2.2 Pavojaus simboliai

Pavojaus simboliai yra simboliniai atvaizdai, nurodantys pavojaus rūšį.

Šiame: dokumente naudojami tokie pavojaus simboliai

Pavojaus simbolis	Reikšmė
	Bendras įspėjamasis pranešimas
	Pavojinga elektros įtampa
	Sprogimo pavojus
	Įpjovimo pavojus
	Prispaudimo pavojus

## **i** Dėl šio dokumento

Pavojaus simbolis	Reikšmė
	Pavojus dėl karštų paviršių
	Pavojus dėl stipraus magnetinio lauko
	Pavojus dėl nejonizuojančiosios spinduliuotės

Lentelė 2: Pavojaus simboliai

### 1.2.3 Įspėjimų struktūra

Šiame dokumente pateikiami įspėjimai yra standartizuotos išvaizdos ir standartizuotos struktūros.



	<div style="background-color: red; color: white; padding: 2px; text-align: center;"><b>⚠ PAVOJUS</b></div> <p><b>Pavojaus tipas ir šaltinis!</b> Galimos pasekmės, jei nepaisoma pavojaus / įspėjimo.</p> <ul style="list-style-type: none"> <li>▶ Priemonės ir draudimai pavojui išvengti.</li> </ul>
--	--





Šiame pavyzdyje parodytas įspėjimas, įspėjantis apie elektros smūgį dėl dalių su įtampa. Paminėta priemonė, kaip išvengti pavojaus.

	<div style="background-color: red; color: white; padding: 2px; text-align: center;"><b>⚠ PAVOJUS</b></div> <p><b>Elektros smūgio pavojus dėl dalių, kuriose yra įtampa!</b> Mirtis dėl elektros smūgio</p> <ul style="list-style-type: none"> <li>▶ Prieš pradėdami remontą, ne mažiau kaip prieš 60 sekundžių atjunkite prietaisus nuo elektros tiekimo.</li> </ul>
---	--

### 1.2.4 Bendrieji simboliai

Šiame dokumente naudojami tokie bendrieji simboliai:

Bendr. simbolis	Reikšmė
	Žymi specialų patarimą (tekstas ir (arba) grafika)
	Žymi paprastą patarimą (tik tekstas)
	Žymi nuorodą į vaizdo pamoką

Bendr. simbolis	Reikšmė
	Žymi reikalingus įrankius
	Žymi reikalingas prielaidas
	Žymi sąlygą (jei ..., tai ...)
	Žymi rezultatą
<input type="text" value="Paleisti"/>	Žymi klavišą arba ekrano mygtuką
<input type="text" value="[00123456]"/>	Žymi dalies numerį
Būsena	Žymi rodomą tekstą / langą (prietaiso ekrane)

Lentelė 3: Bendrieji simboliai



## 2.1 Bendrosios saugos instrukcijos

### 2.1.1 Visi būtiniai prietaisai

#### **Elektros smūgio pavojus dėl dalių, kuriose yra įtampa!**

- Elektrinių konstrukcinių dalių remonto klaidos gali sukelti elektros smūgį!
- Prieš pradėdami dirbti, ne mažiau kaip prieš 60 sekundžių atjunkite prietaisą nuo maitinimo.
- Po remonto pasirūpinkite, kad būtų atliktas saugos bandymas pagal VDE 0701 arba šalyje galiojančius reglamentus.

#### **Pavojus susižeisti į aštrias briaunas!**

- Mūvėkite apsaugines pirštines.

#### **Prispaudimo rizika remonto, einamosios techninės priežiūros, sutrikimų šalinimo ir techninės priežiūros metu dėl sunkių ir judančių konstrukcinių dalių**

- Avėkite apsauginius batus.
- Apsaugokite sunkias konstrukcines dalis, kad jos nenukristų.
- Neartinkite kūno dalių prie judančių konstrukcinių dalių.



#### **Rizika prietaiso saugai / veikimui!**

- Naudokite tik originalias atsargines dalis.

#### **Elektrostatškai jautrių konstrukcinių dalių (ESD) pažeidimo rizika!**

- Nelieskite modulių, o taip pat ir jų jungčių bei laidininkų kelių.

## Įrankiai ir pagalbinės priemonės

Paskyrimas	Išsami informacija	Vaizdai
Apsauginis audinys [00342013]	60 cm x 50 cm	
Siurbtukas [00342224]	Ø50 mm	
„Torx“ antgalis TX20 [00340865]	6,3 mm (1/4 col.)	

## 4.1 Durelių tarpiklio keitimas

### Reikalavimas.

- ✔ Durelės turi būti atidarytos.

### 4.1.1 Durelių tarpiklio išėmimas

1. Išimkite durelių tarpiklį iš griovelio dešiniame ir kairiajame kampe.



2. Ištraukite durelių tarpiklį iš griovelio.



- ➡ Durelių tarpiklis išimtas.

### 4.1.2 Durelių tarpiklio įdėjimas



Naujo durelių tarpiklio storis gali šiek tiek skirtis nuo seno durelių tarpiklio storio. Dėl to durelės vis tiek užsidarys, o tarpiklį bus galima naudoti ilgai. Jei jūsų prietaiso vyriai arba vyro priedai reguliuojami, uždarymo funkciją vėliau galima optimizuoti. Nedidelės šoninės skylutės durelių tarpiklyje turi savo funkciją (reikalingos ventilacijai). Tai nėra gamybinis brokas.

1. Patikrinkite griovelį, ar nėra tarpiklį galinčių pažeisti vietų.

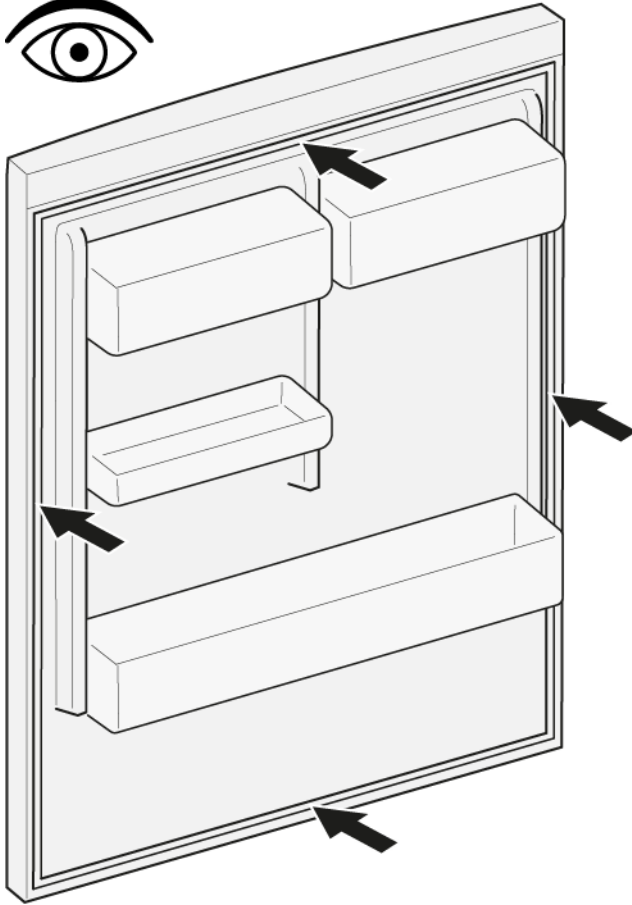

4. Įspauskite tarpiklio kampus viršuje ir apačioje į griovelį.

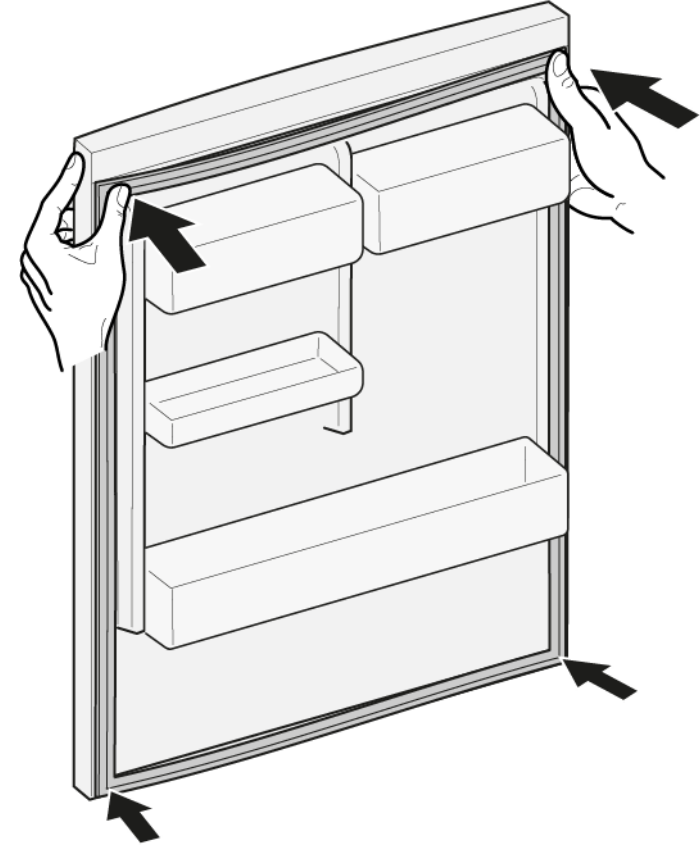

2.  Jei tarpiklio griovelis pažeistas.  
- Kreipkitės į klientų aptarnavimo tarnybą.

3.  Nedidelės durelių tarpiklio deformacijos yra įprastas požymis ir nepaveikia tarpiklio funkcinių savybių. Prieš įdedant durelių tarpiklį į prietaisą, rekomenduojama jį ištiesinti.

Pašildykite durelių tarpiklį plaukų džiovintuvu arba karštu vandeniu ir iš naujo suteikite formą rankiniu būdu.

5. Po truputį įspauskite į griovelį visą tarpiklį.

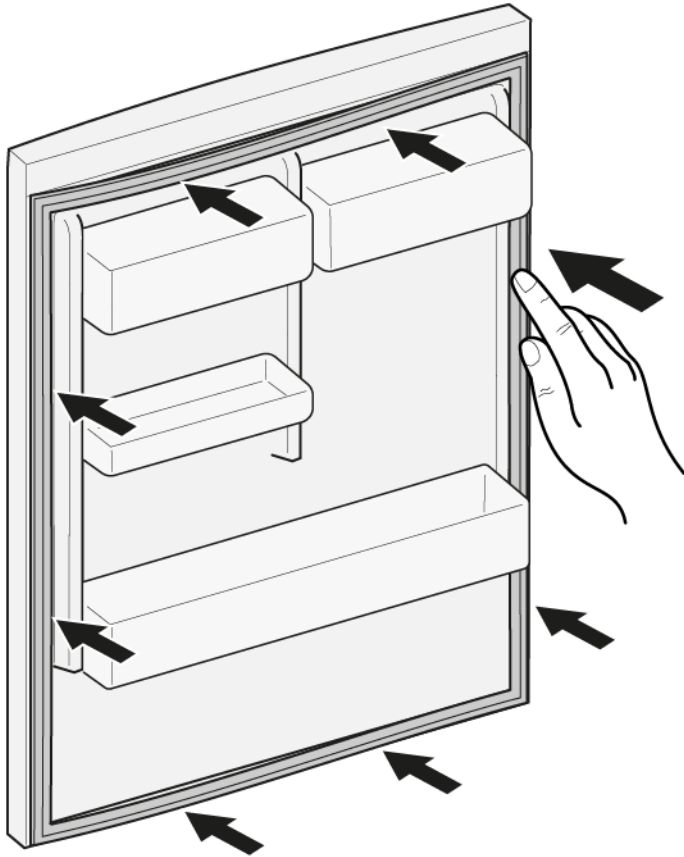

 Durelių tarpiklis įdėtas.

## 4.2 Atlenkiamo vyrio keitimas

### Specialūs įrankiai.

„Torx“ antgalis TX20

6,3 mm (1/4 col.)

[00340865]

	<b>⚠️ ĮSPĖJIMAS</b>
	<p><b>Sunkūs ir dideli prietaisai!</b> Nugaros ir raumenų sužalojimai</p> <ul style="list-style-type: none"> <li>▶ Prietaiso dureles nuimti gali tik apmokyti specialistai.</li> <li>▶ Norint perkelti prietaisą į kitą vietą, reikalingi du žmonės.</li> <li>▶ Naudokite tik tinkamus įrankius ir įrangą.</li> </ul>

	<b>⚠️ PERSPĖJIMAS</b>
	<p><b>Aštrios briaunos!</b> Galima įsijauti</p> <ul style="list-style-type: none"> <li>▶ Mūvėkite apsaugines pirštines.</li> </ul>

	<b>⚠️ PERSPĖJIMAS</b>
	<p><b>Atvira vyrių sritis!</b> Galima prispausti / prisiverti pirštus</p> <ul style="list-style-type: none"> <li>▶ Nekiškite rankų į vyrių sritį.</li> <li>▶ Mūvėkite apsaugines pirštines.</li> </ul>

	<b>⚠️ PERSPĖJIMAS</b>
	<p><b>Pavojus, kad atpalaidavus varžtus dalys nukris!</b> Krentančios dalys gali sužeisti.</p> <ul style="list-style-type: none"> <li>▶ Apsaugokite konstrukcinę dalį, kad ji nenukristų.</li> </ul>

	<b>DĖMESIO!</b>
	<p><b>Pavojus, kad atpalaidavus varžtus dalys nukris!</b> Gali būti sugadintos kitos prietaiso dalys arba kliento namai, pvz., grindys.</p> <ul style="list-style-type: none"> <li>▶ Apsaugokite konstrukcinę dalį, kad ji nenukristų.</li> </ul>

### Reikalavimas.

- ✔️ Prietaisas turi būti atjungtas nuo maitinimo šaltinio.
- ✔️ Baldų durelės turi būti nuimtos. Žr. „Įrengimo instrukcija“.
- ✔️ Durelės turi būti atidarytos.

## 4.2.1 Atlenkiamo vyrio nuėmimas

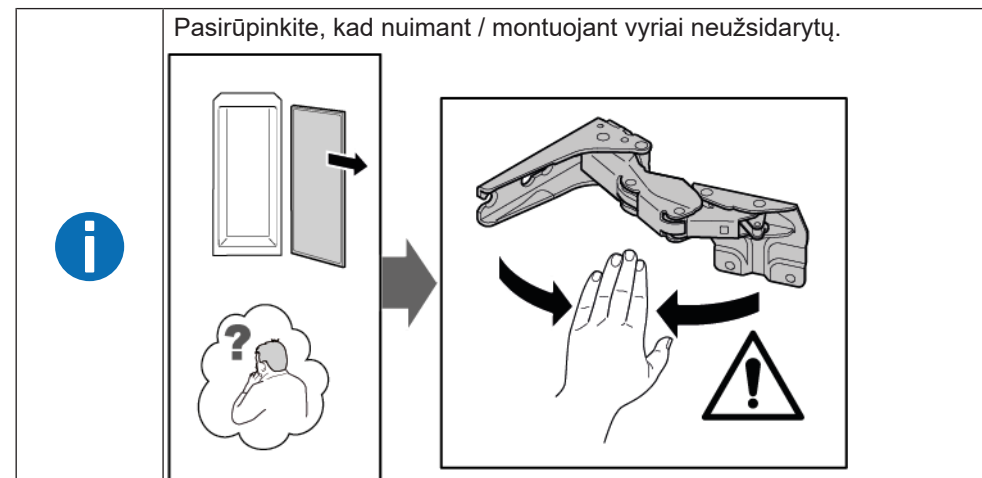

1. Nuimkite nuo dviejų vyrių dangtelius.

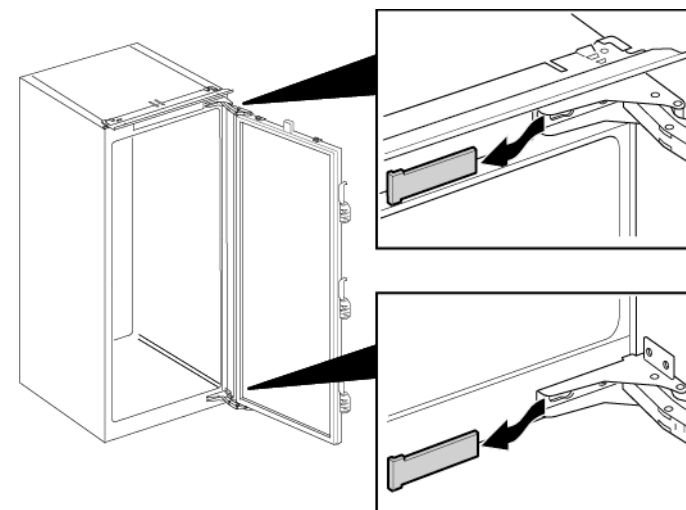

## Remontas

2. 1. Atleiskite keturis varžtus (1).
2. Patraukite ir išimkite dureles (2).

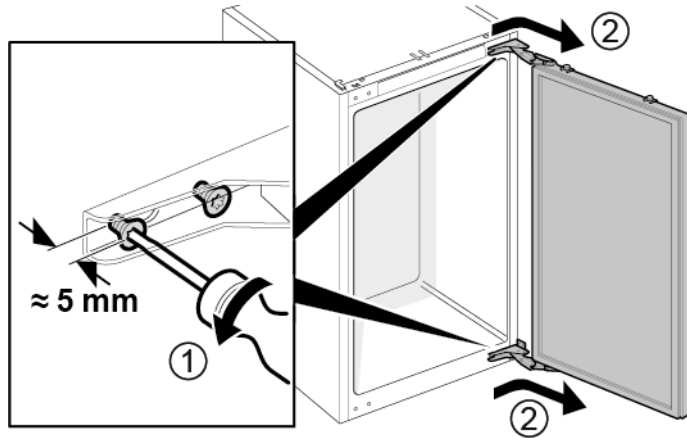

3. 1. Išsukite keturis varžtus (1).
2. Nuimkite vyrius (2).

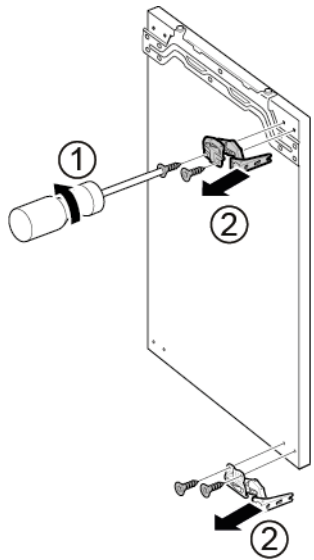

 Vyriai nuimti.

### 4.2.2 Atlenkiamo vyrio montavimas

- Uždėkite atvirkščia eilės tvarka.





## 4.3 Slankiojo vyro keitimas

### Specialūs įrankiai.

„Torx“ antgalis TX20

6,3 mm (1/4 col.)

[00340865]

	<p style="text-align: center;"><b>⚠️ ĮSPĖJIMAS</b></p> <p><b>Sunkūs ir dideli prietaisai!</b> Nugaros ir raumenų sužalojimai</p> <ul style="list-style-type: none"> <li>▶ Prietaiso dureles nuimti gali tik apmokyti specialistai.</li> <li>▶ Norint perkelti prietaisą į kitą vietą, reikalingi du žmonės.</li> <li>▶ Naudokite tik tinkamus įrankius ir įrangą.</li> </ul>
	<p style="text-align: center;"><b>⚠️ PERSPĖJIMAS</b></p> <p><b>Aštrios briaunos!</b> Galima įsipjauti</p> <ul style="list-style-type: none"> <li>▶ Mūvėkite apsaugines pirštines.</li> </ul>
	<p style="text-align: center;"><b>⚠️ PERSPĖJIMAS</b></p> <p><b>Pavojus, kad atpalaidavus varžtus dalys nukris!</b> Krentančios dalys gali sužeisti.</p> <ul style="list-style-type: none"> <li>▶ Apsaugokite konstrukcinę dalį, kad ji nenukristų.</li> </ul>
	<p style="text-align: center;"><b>DĖMESIO!</b></p> <p><b>Pavojus, kad atpalaidavus varžtus dalys nukris!</b> Gali būti sugadintos kitos prietaiso dalys arba kliento namai, pvz., grindys.</p> <ul style="list-style-type: none"> <li>▶ Apsaugokite konstrukcinę dalį, kad ji nenukristų.</li> </ul>

### Reikalavimas.

- ✔️ Prietaisas turi būti atjungtas nuo maitinimo šaltinio.
- ✔️ Baldų ir prietaiso durelės yra atskiros. Žr. „Įrengimo instrukcija“.

### 4.3.1 Slankiojo vyro nuėmimas

- ▶ 1. Išsukite du varžtus (1).
- ▶ 2. Nuimkite viršutinį vyrį (2).
- ▶ 3. Nuimkite dureles (3).
- ▶ 4. Išsukite du varžtus (4).
- ▶ 5. Nuimkite apatinį vyrį (5).

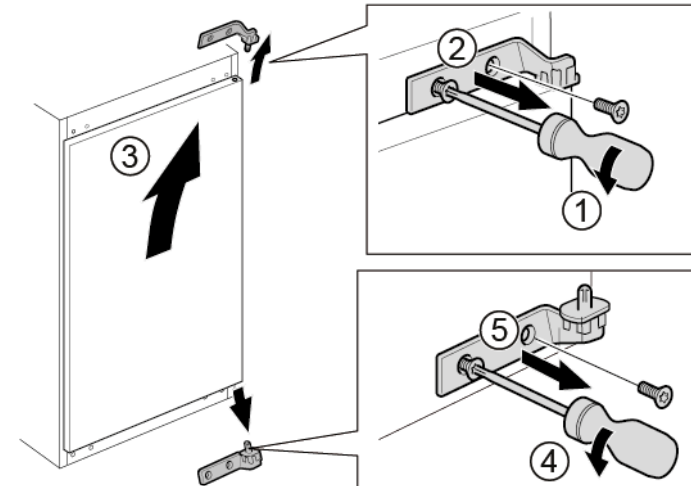

➡ Vyriai nuimti.

### 4.3.2 Slankiojo vyro montavimas

- ▶ Uždėkite atvirkščia eilės tvarka.



## 4.4 Lentynos keitimas

### Reikalavimas.

- ✔ Durelės turi būti atidarytos.

### 4.4.1 Lentynos nuėmimas

- ▶ Ištraukite lentyną.

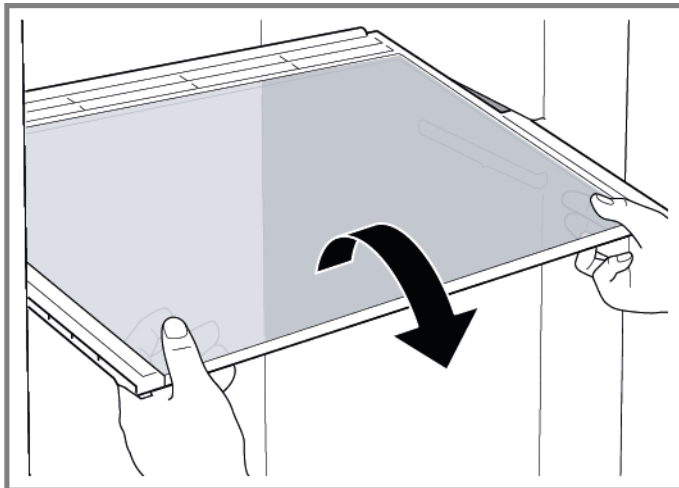

- ➡ Lentyna išimta.

### 4.4.2 Lentynos įdėjimas

- ▶ Uždėkite atvirkščia eilės tvarka.

## 4.5 Durelių lentynos keitimas

### Reikalavimas.

- ✔ Durelės turi būti atidarytos.

### 4.5.1 Durelių lentynos išėmimas

- ▶ Pakelkite durelių lentyną į viršų.

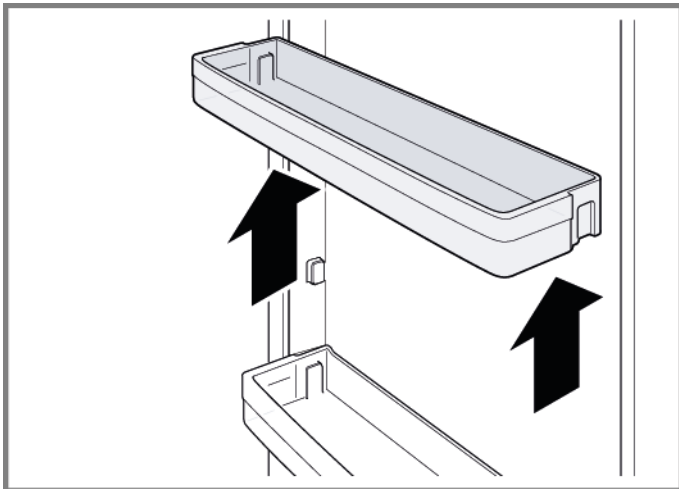

- ➡ Durelių lentyna išimta.

### 4.5.2 Durelių lentynos įdėjimas

- ▶ Uždėkite atvirkščia eilės tvarka.

## 4.6 Vaisių ir daržovių talpyklos keitimas

### Reikalavimas.

- ✔ Durelės turi būti atidarytos.

### 4.6.1 Vaisių ir daržovių talpyklos išėmimas

1. Ištraukite vaisių ir daržovių talpyklą, tiek, kiek galima.
2. 1. Pakelkite vaisių ir daržovių talpyklos priekį (1).  
2. Išimkite talpyklą (2).

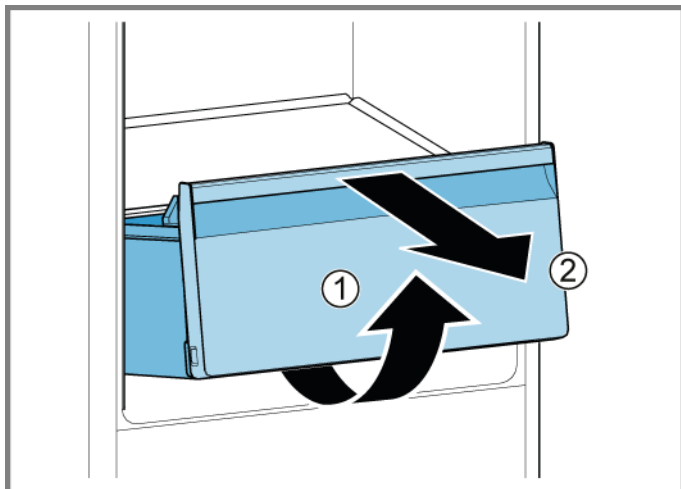

- ➔ Vaisių ir daržovių talpykla išimta.

### 4.6.2 Vaisių ir daržovių talpyklos įdėjimas

- ▶ Uždėkite atvirkščia eilės tvarka.

## 4.7 Šoninės LED lemputės keitimas

### Specialūs įrankiai.

Siurbtukas Ø50 mm [00342224]

**i** Jūsų prietaise įrengta techninės priežiūros nereikalaujanti LED lemputė. Šią lemputę gali taisyti tik klientų aptarnavimo tarnybos specialistai arba įgalioti technikai!

**⚠ PAVOJUS**  
**Elektros smūgio pavojus dėl dalių, kuriose yra įtampa!**  
Pavojus gyvybei dėl elektros smūgio netinkamo remonto atveju

- ▶ Elektrinės dalis remontuoti turi kvalifikuoti elektrikai.
- ▶ Po remonto pasirūpinkite, kad būtų atliktas saugos bandymas pagal VDE 0701 arba šalyje galiojančius reglamentus.

**⚠ PAVOJUS**  
**Elektros smūgio pavojus dėl dalių, kuriose yra įtampa!**  
Mirtis dėl elektros smūgio

- ▶ Prieš pradėdami remontą, ne mažiau kaip prieš 60 sekundžių atjunkite prietaisus nuo elektros tiekimo.

**⚠ PERSPĖJIMAS**  
**Aštrios briaunos!**  
Galima įsipjauti

- ▶ Mūvėkite apsaugines pirštines.

### Reikalavimas.

- ✓ Prietaisas turi būti atjungtas nuo maitinimo šaltinio.
- ✓ Durelės turi būti atidarytos.
- ✓ Lentynos išimtos.

### 4.7.1 Šoninės LED lemputės išėmimas

1. Prilipdykite du siurbtukus prie LED šoninės lemputės dangtelio.

2. Patraukite siurbtukus į priekį vienu sukamuoju judesiu.

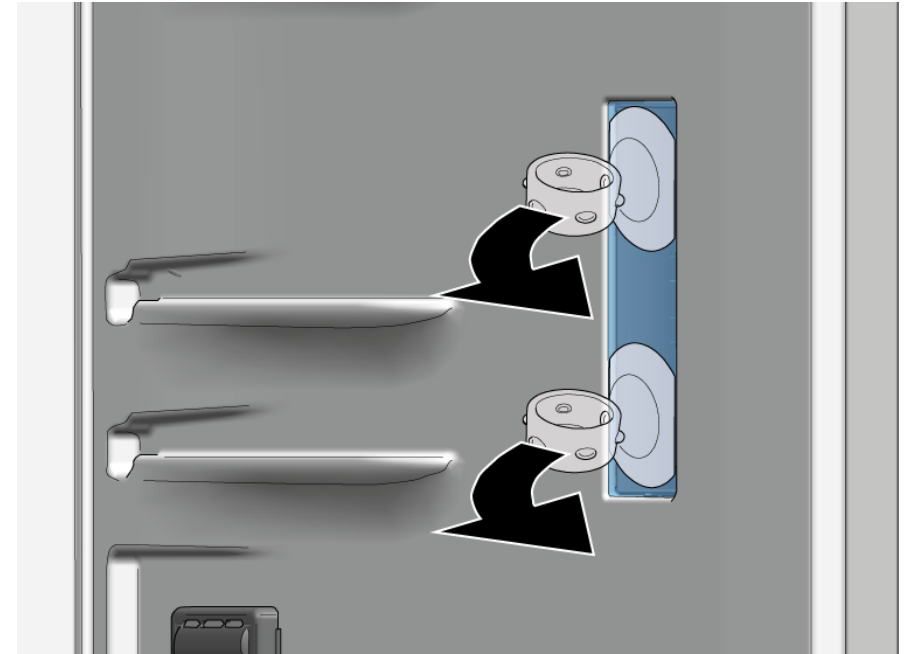

- ➡ LED lemputės dangtis nuimtas.

3. Išimkite LED modulį.



 Šoninė LED lemputė išimta.

### 4.7.2 Šoninės LED lemputės montavimas



Dėl lemputės dangtelio išimant kabliukus galima lengvai nulaužti; atsarginė LED šoninė lemputė yra komplektas, į kurį įeina LED modulis ir lemputės dangtelis.

- ▶ Uždėkite atvirkščia eilės tvarka.

# Reparasjonstips - Kjøleskap

 <b>Om dette dokumentet</b> .....	<b>243</b>
1.1 Viktig informasjon .....	243
1.1.1 Formål.....	243
1.2 Forklaring av symboler.....	243
1.2.1 Farenivåer .....	243
1.2.2 Faresymboler.....	243
1.2.3 Advarslenes struktur .....	244
1.2.4 Generelle symboler .....	244
 <b>Sikkerhet</b> .....	<b>245</b>
2.1 Generelle sikkerhetsinstruksjoner .....	245
2.1.1 Alle husholdningsapparater .....	245
 <b>Verktøy og hjelpemidler</b> .....	<b>246</b>
 <b>Reparasjon</b> .....	<b>247</b>
4.1 Utskiftning av dørpakning.....	247
4.1.1 Demontering av dørpakning.....	247
4.1.2 Montering av dørpakning .....	247
4.2 Utskiftning av flat hengsel .....	250
4.2.1 Demontering av flat hengsel .....	250
4.2.2 Montering av flat hengsel.....	251
4.3 Utskiftning av glidehengsel.....	252
4.3.1 Demontering av glidehengsel.....	252
4.3.2 Montering av glidehengsel .....	252
4.4 Utskiftning av hylle.....	253
4.4.1 Demontering av hylle.....	253
4.4.2 Montering av hylle .....	253
4.5 Utskiftning av dørrack .....	254
4.5.1 Demontering av dørrack .....	254
4.5.2 Montering av dørrack .....	254
4.6 Utskiftning av frukt- og grønnsaksbeholder.....	255
4.6.1 Demontering av frukt- og grønnsaksbeholder.....	255
4.6.2 Montering av frukt- og grønnsaksbeholder .....	255
4.7 Utskiftning av LED-sidelampe.....	256
4.7.1 Demontering av LED-sidelampe.....	256
4.7.2 Montering av LED-sidelampe .....	257

# i Om dette dokumentet

## 1.1 Viktig informasjon

### 1.1.1 Formål

Disse tipsene om reparasjon skal hjelpe kunden til selv å kunne reparere apparater i samsvar med gjeldende regulering av øko-design (med gyldighet 03/2021).



De inneholder informasjon om hvordan definerte reservedeler skiftes, inklusive advarsler og risikoer.

Kontakt vår kundeservice dersom du har spørsmål. Vi påtar oss kun ansvar for skader dersom tipsene om reparasjon er korrekt fulgt.

## 1.2 Forklaring av symboler

### 1.2.1 Farenivåer

Advarslene som viser farenivå, består av et symbol og et signalord. Signalordet viser hvor alvorlig faren er.





Advarsel som viser farenivå	Betydning
	Dersom advarselen ignoreres, vil det føre til død eller alvorlige personskader.
	Dersom advarselen ignoreres, kan det føre til død eller alvorlige personskader.
	Dersom advarselen ignoreres, kan det føre til mindre personskader.
	Dersom advarselen ignoreres, kan det føre til materiell skade.

Tabell 1: Farenivåer



### 1.2.2 Faresymboler

Faresymboler er symbolske fremstillinger som gir en indikasjon av hvilken type fare det dreier seg om.

Følgende faresymboler brukes i dette dokumentet:

Faresymbol	Betydning
	Generell advarsel
	Fare for elektrisk støt
	Eksplisjonsfare
	Fare for å skjære seg
	Klemfare



## i Om dette dokumentet

Faresymbol	Betydning
	Fare på grunn av varme overflater
	Fare på grunn av sterkt magnetfelt
	Fare fra ikke-ioniserende stråling



Tabell 2: Faresymboler

### 1.2.3 Advarslenes struktur

Advarslene i dette dokumentet har standardisert utseende og standardisert struktur.



	<div style="background-color: red; color: white; padding: 2px; text-align: center;">  <b>FARE</b> </div> <p><b>Faretype og kilde til fare!</b> Mulige konsekvenser dersom fare/advarsel ignoreres.</p> <ul style="list-style-type: none"> <li>▶ Tiltak og forbud for å forebygge fare.</li> </ul>
--	--







Eksemplet nedenfor viser en advarsel mot elektrisk støt på grunn av strømførende deler. Tiltaket for å unngå faren er angitt.

	<div style="background-color: red; color: white; padding: 2px; text-align: center;">  <b>FARE</b> </div> <p><b>Fare for elektrisk støt på grunn av strømførende deler!</b> Død på grunn av drepende elektrisk støt</p> <ul style="list-style-type: none"> <li>▶ Koble apparatene fra strømforsyningen i minst 60 sekunder før reparasjonene startes.</li> </ul>
---	--

### 1.2.4 Generelle symboler

Følgende generelle symboler brukes i dette dokumentet:

Gen. symbol	Betydning
	Identifisering av et spesielt tips (tekst og/eller grafikk)
	Identifisering av et enkelt tips (kun tekst)
	Identifisering av en lenke til en opplæringsvideo

Gen. symbol	Betydning
	Identifisering av nødvendig verktøy
	Identifisering av nødvendige forutsetninger
	Identifisering av en betingelse (hvis ..., så ...)
	Identifisering av et resultat
	Identifisering av en tast eller knapp
	Identifisering av et materialnummer
	Identifisering av vist tekst/vindu (i apparatets display)

Tabell 3: Generelle symboler



## 2.1 Generelle sikkerhetsinstruksjoner

### 2.1.1 Alle husholdningsapparater

#### **Fare for elektrisk støt på grunn av strømførende deler!**

- Feil ved reparasjoner hvor elektriske komponenter er involvert, kan føre til elektrisk støt!
- Koble apparatet fra strømmettet i minst 60 sekunder før arbeidet startes.
- Etter reparasjonen må du sørge for at det utføres en sikkerhetstest iht. VDE 0701 eller gjeldende forskrifter i det respektive land.

#### **Fare for personskade på grunn av skarpe kanter!**

- Bruk vernehansker.

#### **Fare for å knuse legemsdeler under reparasjoner, vedlikehold, feilsøking og service på grunn av tunge og bevegelige komponenter**

- Bruk vernesko.
- Sikre tunge komponenter for å hindre at de faller ned.
- Ikke stikk kroppsdelene inn i bevegelige komponenter.



#### **Fare for apparatets sikkerhet/funksjon!**

- Bruk kun originale reservedeler.

#### **Fare for skade på deler som er følsomme overfor elektrostatisk utlading (ESD)!**

- Ikke berør modulene, inklusive tilkoblinger og ledere.

## Verktøy og hjelpemidler

Betegnelsen	Detaljer	Bilder
Beskyttelsesklut [00342013]	60 cm x 50 cm	
Sugekopp [00342224]	Ø50 mm	
Torx-bits TX20 [00340865]	6,3 mm (1/4")	

## 4.1 Utskiftning av dørpakning

### Forutsetning:

- ✔ Døren er åpen.

### 4.1.1 Demontering av dørpakning

1. Løsne dørpakningen fra sporet i høyre og venstre hjørne.

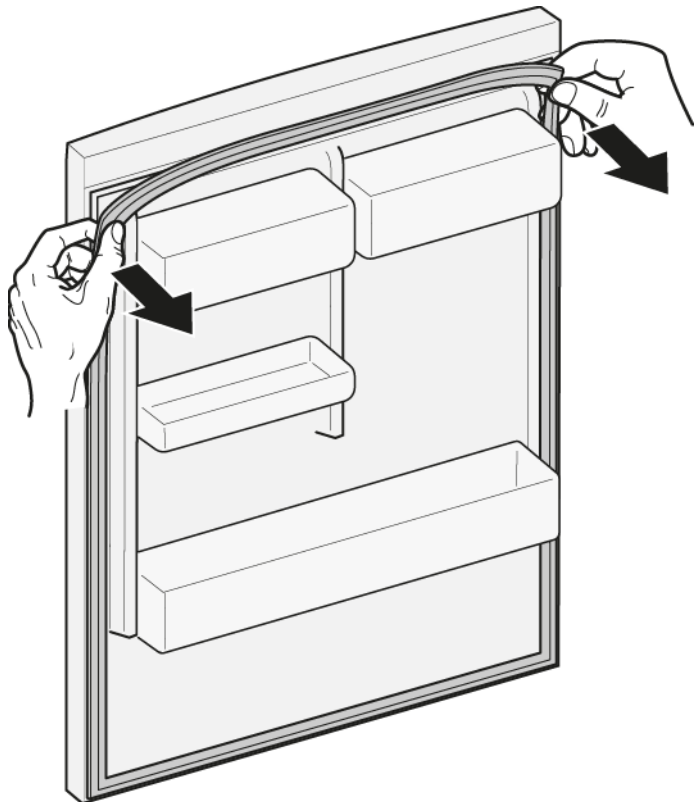

2. Trekk pakningen ut av sporet.



- ➡ Dørpakningen er demontert.

### 4.1.2 Montering av dørpakning



Tykkelsen på den nye dørpakningen kan avvike litt fra tykkelsen på den gamle dørpakningen. Det har ingen innvirkning på lukkeatferd og langvarig funksjon.

Hvis apparatet har justerbare hengsler eller hengslefester, kan du optimalisere lukkeatferden etterpå.

Små sidehull i dørpakningen har en funksjon (nødvendige for ventilasjonen). Det dreier seg ikke om produksjonsfeil.

## Reparasjon

1. Kontroller at sporet for pakningen ikke har skader.

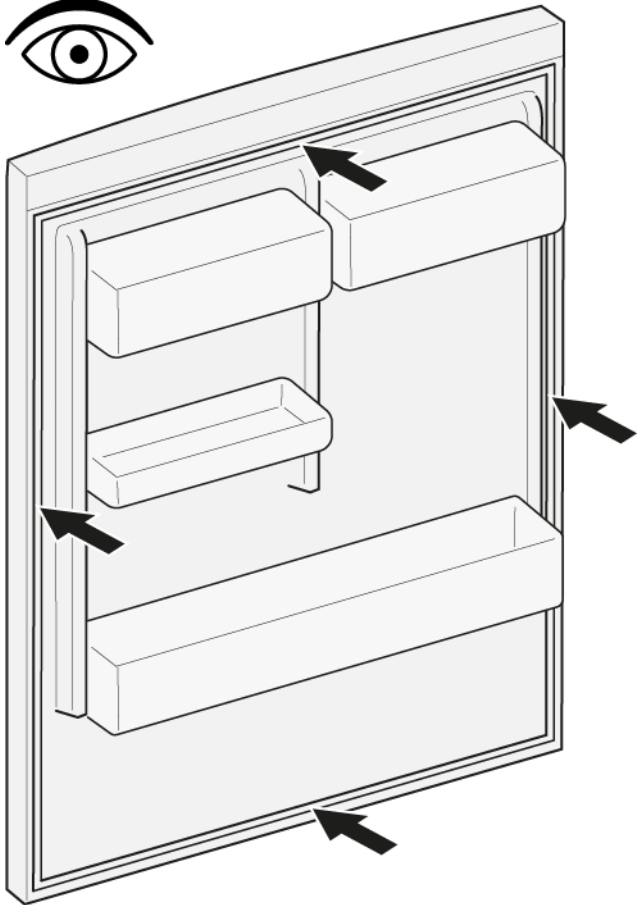

2.  Hvis sporet for pakningen er skadet:
  - Kontakt kundeservice.

3.  Litt deformasjon av dørpakningen er normalt og har ingen innvirkning på funksjonen. Det anbefales å rette ut dørpakningen før den settes inn i apparatet.

Varm opp dørpakningen med en føn eller varmt vann og form den på nytt med hendene.

4. Skyv pakningens hjørner øverst og nederst inn i sporet.

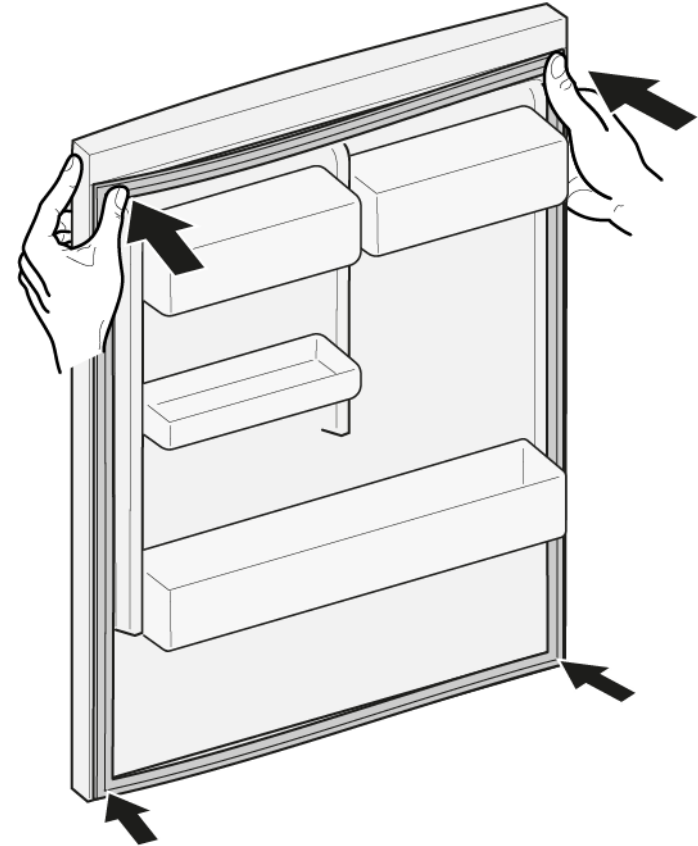

## Reparasjon

5. Trykk hele pakningen inn i sporet trinn for trinn.



 Dørpakningen er montert.

## 4.2 Utskiftning av flat hengsel

### Spesielle hjelpemidler:

Torx-bits TX20

6,3 mm (1/4")

[00340865]

	<b>⚠ ADVARSEL</b>
	<p><b>Tunge, klumpete apparater!</b> Rygg- og muskelskader</p> <ul style="list-style-type: none"> <li>▶ Arbeidet med å demontere apparatets dør skal bare utføres av opplærte spesialister.</li> <li>▶ Det kreves to personer for å flytte på apparatet.</li> <li>▶ Bruk kun egnet verktøy og utstyr.</li> </ul>

	<b>⚠ FORSIKTIG</b>
	<p><b>Skarpe kanter!</b> Kuttskader</p> <ul style="list-style-type: none"> <li>▶ Bruk vernehansker.</li> </ul>

	<b>⚠ FORSIKTIG</b>
	<p><b>Åpent hengsleområde!</b> Fare for å knuse/sette fast fingre</p> <ul style="list-style-type: none"> <li>▶ Ikke grip inn i hengsleområdet.</li> <li>▶ Bruk vernehansker.</li> </ul>

	<b>⚠ FORSIKTIG</b>
	<p><b>Fare for at deler kan falle ned på grunn av løsnede skruer!</b> Personskade på grunn av fallende deler.</p> <ul style="list-style-type: none"> <li>▶ Sikre komponenten så den ikke kan falle ned.</li> </ul>

	<b>OBS!</b>
	<p><b>Fare for at deler kan falle ned på grunn av løsnede skruer!</b> Skade på andre deler på apparatet eller i kundens hjem, f.eks. gulv.</p> <ul style="list-style-type: none"> <li>▶ Sikre komponenten så den ikke kan falle ned.</li> </ul>

### Forutsetning:

- ✔ Apparatet kobles fra strømforsyningen.
- ✔ Dør på møbel er demontert. Se monteringsanvisningen.
- ✔ Døren er åpen.

### 4.2.1 Demontering av flat hengsel

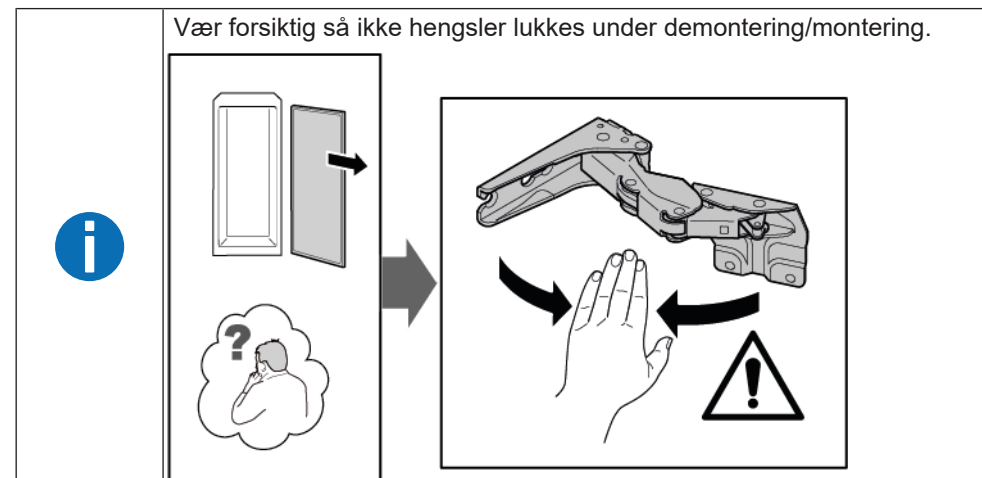

1. Ta av to hengsledeksler.

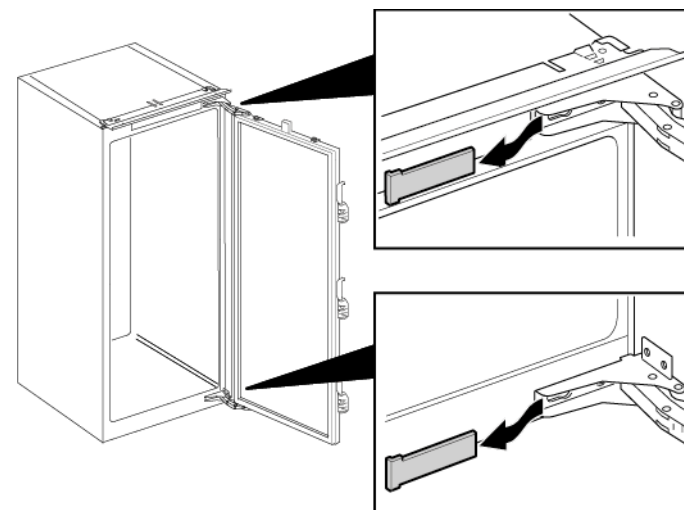

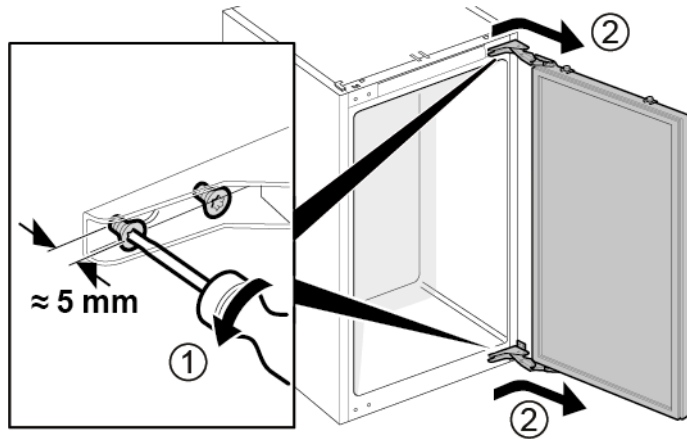

## Reparasjon

2. 1. Løsne fire skruer (1).
2. Skyv ut døren og fjern den (2).

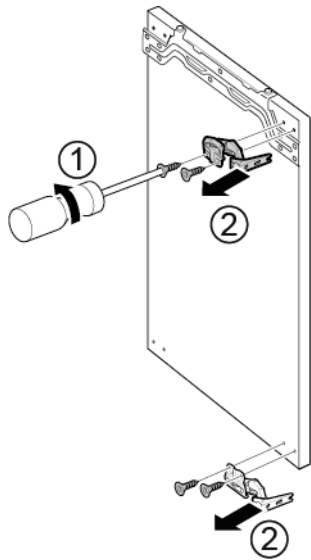

3. 1. Fjern fire skruer (1).
2. Demonter hengslene (2).



 Hengslene er demontert.

### 4.2.2 Montering av flat hengsel

- ▶ Monteres i motsatt rekkefølge.

## 4.3 Utskiftning av glidehengsel

### Spesielle hjelpemidler:

Torx-bits TX20 6,3 mm (1/4") [00340865]

	<p><b>⚠ ADVARSEL</b></p> <p><b>Tunge, klumpete apparater!</b> Rygg- og muskelskader</p> <ul style="list-style-type: none"><li>▶ Arbeidet med å demontere apparatets dør skal bare utføres av opplærte spesialister.</li><li>▶ Det kreves to personer for å flytte på apparatet.</li><li>▶ Bruk kun egnet verktøy og utstyr.</li></ul>
--	---

	<p><b>⚠ FORSIKTIG</b></p> <p><b>Skarpe kanter!</b> Kuttskader</p> <ul style="list-style-type: none"><li>▶ Bruk vernehansker.</li></ul>
--	--

	<p><b>⚠ FORSIKTIG</b></p> <p><b>Fare for at deler kan falle ned på grunn av løsnede skruer!</b> Personskade på grunn av fallende deler.</p> <ul style="list-style-type: none"><li>▶ Sikre komponenten så den ikke kan falle ned.</li></ul>
--	--

	<p><b>OBS!</b></p> <p><b>Fare for at deler kan falle ned på grunn av løsnede skruer!</b> Skade på andre deler på apparatet eller i kundens hjem, f.eks. gulv.</p> <ul style="list-style-type: none"><li>▶ Sikre komponenten så den ikke kan falle ned.</li></ul>
---	--

### Forutsetning:

- ✓ Apparatet kobles fra strømforsyningen.
- ✓ Dør på møbel og apparatets dør er skilt fra hverandre. Se monteringsanvisningen.

### 4.3.1 Demontering av glidehengsel

- ▶ 1. Skru ut to skruer (1).
- ▶ 2. Demonter øvre hengsel (2).
- ▶ 3. Demonter døren (3).
- ▶ 4. Skru ut to skruer (4).
- ▶ 5. Demonter nedre hengsel (5).

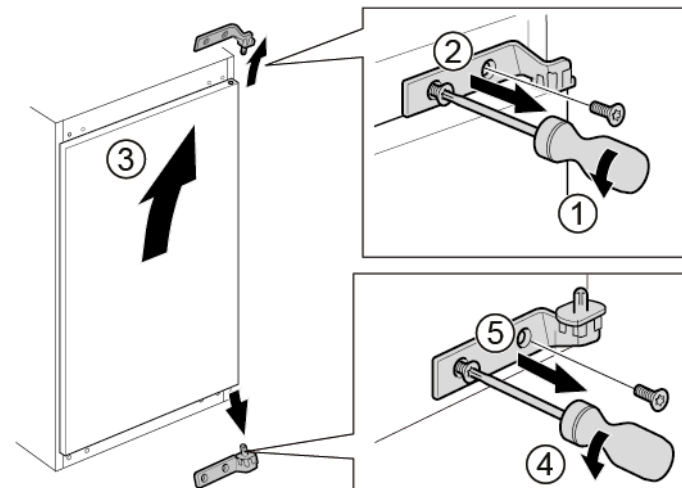

➡ Hengslene er demontert.

### 4.3.2 Montering av glidehengsel

- ▶ Monteres i motsatt rekkefølge.



## 4.4 Utskiftning av hylle

### Forutsetning:

- ✔ Døren er åpen.

### 4.4.1 Demontering av hylle

- ▶ Trekk ut hyllen.



- ➡ Hyllen er demontert.

### 4.4.2 Montering av hylle

- ▶ Monteres i motsatt rekkefølge.

## 4.5 Utskiftning av dørrack

Forutsetning:

- ✔ Døren er åpen.

### 4.5.1 Demontering av dørrack

- ▶ Løft dørracken opp.

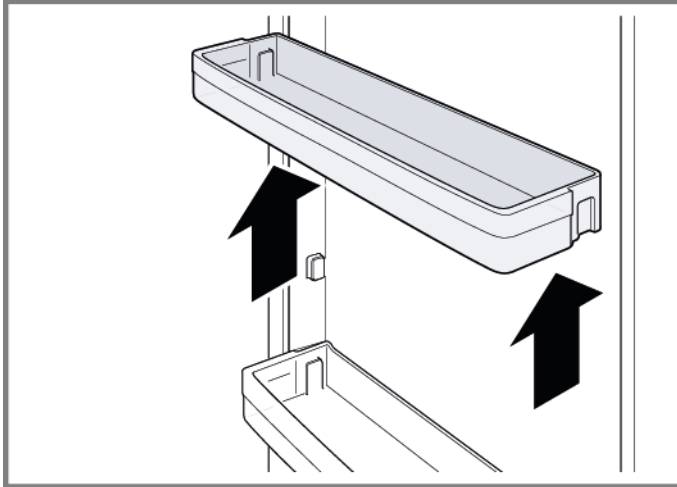

➡ Dørracken er demontert.

### 4.5.2 Montering av dørrack

- ▶ Monteres i motsatt rekkefølge.

## 4.6 Utskiftning av frukt- og grønnsaksbeholder

Forutsetning:

- ✔ Døren er åpen.

### 4.6.1 Demontering av frukt- og grønnsaksbeholder

1. Trekk ut frukt- og grønnsaksbeholderen så langt det går.
2. 1. Løft frukt- og grønnsaksbeholderen foran (1).  
2. Fjern beholderen (2).



- ➡ Frukt- og grønnsaksbeholderen er demontert.

### 4.6.2 Montering av frukt- og grønnsaksbeholder

- ▶ Monteres i motsatt rekkefølge.

## 4.7 Utskiftning av LED-sidelampe

### Spesielle hjelpemidler:

Sugekopp Ø50 mm [00342224]

**i** Apparatet har en vedlikeholdsfri LED-lampe.  
Disse lampene skal kun repareres av kundeservice eller autoriserte teknikere!

**FARE**  
**Fare for elektrisk støt på grunn av strømførende deler!**  
Livsfare på grunn av elektrisk støt ved feil reparasjon

- ▶ Elektriske deler skal repareres av kvalifiserte elektrikere.
- ▶ Etter reparasjonen må du sørge for at det utføres en sikkerhetstest iht. VDE 0701 eller gjeldende forskrifter i det respektive land.

**FARE**  
**Fare for elektrisk støt på grunn av strømførende deler!**  
Død på grunn av døpende elektrisk støt

- ▶ Koble apparatene fra strømforsyningen i minst 60 sekunder før reparasjonene startes.

**FORSIKTIG**  
**Skarpe kanter!**  
Kuttskader

- ▶ Bruk vernehansker.

### Forutsetning:

- ✓ Apparatet kobles fra strømforsyningen.
- ✓ Døren er åpen.
- ✓ Hyllene er tatt ut.

### 4.7.1 Demontering av LED-sidelampe

1. Fest to sugekopper på LED-sidelampedeckslet.

2. Trekk sugekoppene forover med en roterende bevegelse.

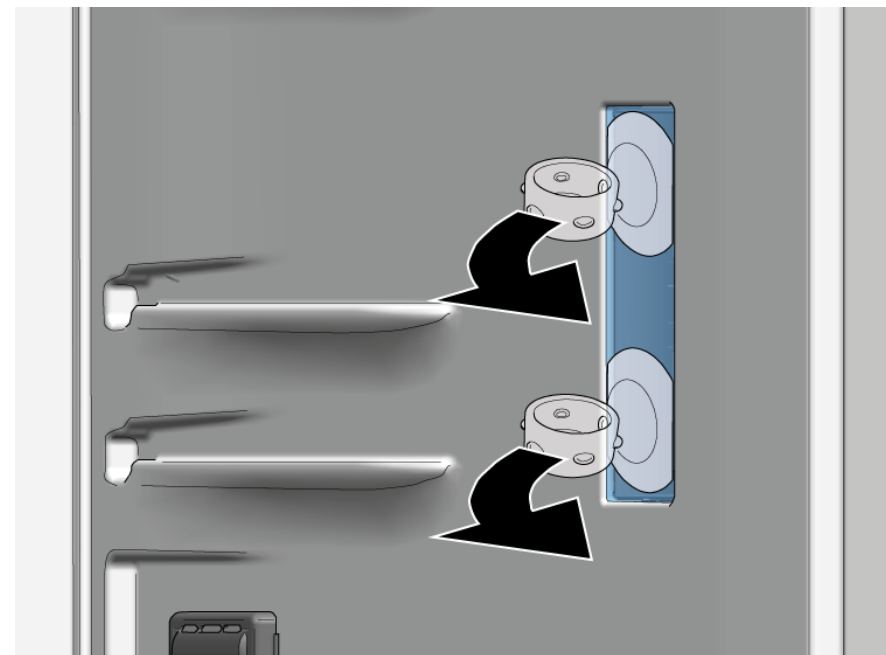

LED-lampedeckslet er demontert.

## Reparasjon

3. Demonter LED-modulen.

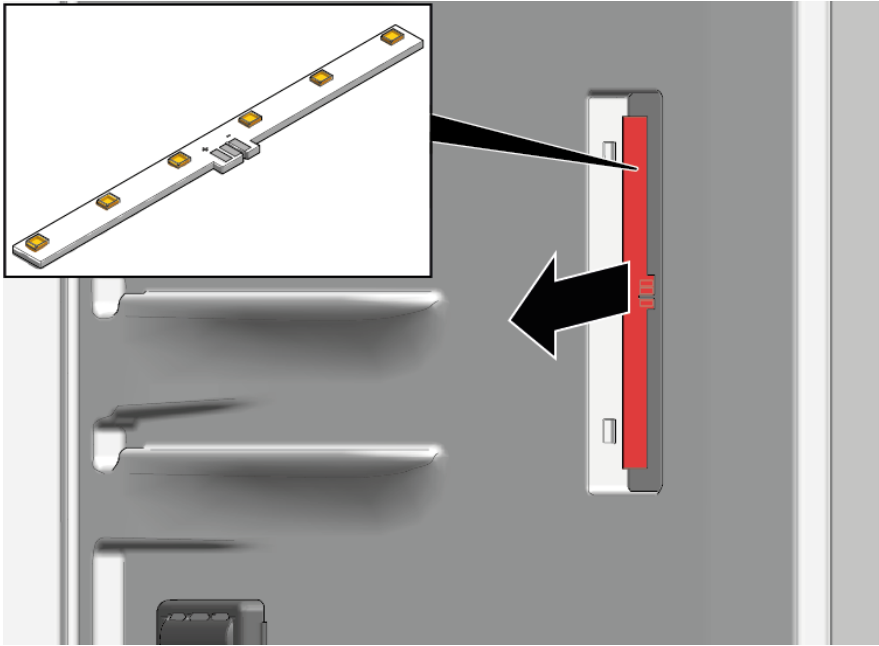

 LED-sidelampen er demontert.





### 4.7.2 Montering av LED-sidelampe



Etttersom lampedekselkrokene lett kan brekk under demonteringen, finnes det en LED-sidelampe som reservedel i settet med LED-modulen og lampedekslet.

- ▶ Monteres i motsatt rekkefølge.

# Wskazówki naprawy - Chłodziarka

 <b>Informacje dotyczące dokumentu .....</b>	<b>259</b>
1.1 Ważne informacje.....	259
1.1.1 Cel dokumentu .....	259
1.2 Objasnienie symboli ostrzegawczych.....	259
1.2.1 Oznaczenie poziomów niebezpieczeństwa .....	259
1.2.2 Symbole ostrzegawcze.....	259
1.2.3 Budowa ostrzeżeń .....	260
1.2.4 Ogólne symbole.....	260
 <b>Bezpieczeństwo.....</b>	<b>261</b>
2.1 Ogólne informacje dotyczące bezpieczeństwa.....	261
2.1.1 Wszystkie sprzęty gospodarstwa domowego .....	261
 <b>Narzędzia i pomoce techniczne .....</b>	<b>262</b>
 <b>Naprawy.....</b>	<b>263</b>
4.1 Wymiana uszczelki drzwiczek .....	263
4.1.1 Demontaż uszczelki drzwiczek.....	263
4.1.2 Montaż uszczelki drzwiczek.....	263
4.2 Wymiana zawiasu płaskiego .....	266
4.2.1 Demontaż zawiasu płaskiego.....	266
4.2.2 Montaż zawiasu płaskiego.....	267
4.3 Wymiana zawiasu suwakowego .....	268
4.3.1 Demontaż zawiasu suwakowego .....	268
4.3.2 Montaż zawiasu suwakowego.....	268
4.4 Wymiana półki.....	269
4.4.1 Demontaż półki .....	269
4.4.2 Montaż półki .....	269
4.5 Wymiana półki drzwiczek .....	270
4.5.1 Demontaż półki drzwiczek .....	270
4.5.2 Montaż półki drzwiczek.....	270
4.6 Wymiana pojemnika na owoce i warzywa .....	271
4.6.1 Demontaż pojemnika na owoce i warzywa.....	271
4.6.2 Montaż pojemnika na owoce i warzywa.....	271
4.7 Wymiana oświetlenia bocznego LED .....	272
4.7.1 Demontaż oświetlenia bocznego LED .....	272
4.7.2 Montaż bocznego oświetlenia LED.....	273

# **i** Informacje dotyczące dokumentu

## 1.1 Ważne informacje

### 1.1.1 Cel dokumentu

Niniejsze wskazówki naprawcze mają na celu zapewnienie użytkownikowi pomocy w samodzielnej naprawie posiadanych urządzeń w sposób zgodny z obowiązującymi przepisami w sprawie ekoprojektu (stan na 03/2021).

Zawierają one informacje na temat wymiany określonych części zamiennych oraz ostrzeżenia i informacje o zagrożeniach.

W razie pytań należy się skontaktować z naszym działem serwisowym. Odpowiedzialność za szkody ponosimy tylko pod warunkiem prawidłowego stosowania się do wskazówek naprawczych.

## 1.2 Objasnienie symboli ostrzegawczych

### 1.2.1 Oznaczenie poziomów niebezpieczeństwa

Poziom ryzyka jest określany przy pomocy symbolu oraz wyrazu. Wyraz określa poziom ryzyka.



Symbol	Znaczenie
 <b>NIEBEZPIECZEŃSTWO</b>	Bezpośrednio zagrażające niebezpieczeństwo, które przy niezachowaniu odpowiednich środków ostrożności może doprowadzić do śmierci lub poważnych obrażeń.
 <b>OSTRZEŻENIE</b>	Prawdopodobieństwo wystąpienia niebezpieczeństwa, które przy niezachowaniu odpowiednich środków ostrożności może doprowadzić do śmierci lub poważnych obrażeń.
 <b>WAŻNE</b>	Prawdopodobieństwo wystąpienia niebezpieczeństwa, które przy niezachowaniu odpowiednich środków ostrożności może doprowadzić do powstania lekkich obrażeń.
<b>UWAGA!</b>	Ostrzeżenie dot. możliwości powstania szkody materialnej.

Tabela 1: Oznaczenie poziomów niebezpieczeństwa

### 1.2.2 Symbole ostrzegawcze

Symbole ostrzegawcze reprezentują graficznie źródło potencjalnego ryzyka.

W poniższym dokumencie użyto następujących symboli:

Symbole ostrzegawcze	Znaczenie
	Ogólne ostrzeżenie
	Niebezpieczeństwo od napięcia elektrycznego
	Ryzyko wybuchu

## **i** Informacje dotyczące dokumentu







Symbole ostrzegawcze	Znaczenie
	Ryzyko obrażeń (rozcięć)
	Ryzyko zmiżdżenia
	Ryzyko oparzenia
	Silne pole magnetyczne
	Promieniowanie nie-jonizujące

Tabela 2: Symbole ostrzegawcze

### 1.2.3 Budowa ostrzeżeń

Ostrzeżenia podane w dokumencie mają standardową budowę.

	<p><b>⚠ NIEBEZPIECZEŃSTWO</b></p> <p><b>Typ i źródło ryzyka!!</b> Konsekwencje zignorowania.</p> <ul style="list-style-type: none"> <li>▶ Środki ochronne.</li> </ul>
---	---

Kolejne ostrzeżenie wskazuje, jako źródło możliwość porażenia prądem. Wskazano czynności, które mają za zadanie ograniczenie ryzyka.

	<p><b>⚠ NIEBEZPIECZEŃSTWO</b></p> <p><b>Ryzyko porażenia prądem, ze względu na elementy będące pod napięciem!</b> Zagrożenie życia poprzez porażenie prądem</p> <ul style="list-style-type: none"> <li>▶ Odłączyć urządzenie od zasilania sieciowego na 60 sekund przed rozpoczęciem naprawy.</li> </ul>
--	--

### 1.2.4 Ogólne symbole

Poniższe symbole są używane w dokumentacji:







Symbol	Znaczenie
	Identyfikacja specjalnej wskazówki (tekst lub grafika)
	Identyfikacja prostej wskazówki (tylko tekst)
	Identyfikacja linku do pliku wideo
	Identyfikacja narzędzi
	Identyfikacja wstępnych warunków
	Identyfikacja warunku (jeżeli)
	Identyfikacja rezultatu
[Start]	Identyfikacja przycisku
[00123456]	Identyfikacja numeru materiału
Status	Identyfikacja wyświetlanego tekstu / komunikatu (na wyświetlaczu)

Tabela 3: Ogólne symbole



## **2.1 Ogólne informacje dotyczące bezpieczeństwa**

### **2.1.1 Wszystkie sprzęty gospodarstwa domowego**

#### **Ryzyko porażenia prądem elektrycznym wskutek kontaktu z elementami znajdującymi się pod napięciem!**

- Błędna naprawa części elektrycznych może spowodować porażenie prądem elektrycznym!
- Co najmniej 60 sekund przed przystąpieniem do pracy odłączyć urządzenie od sieci elektrycznej.
- Po naprawie należy przeprowadzić test bezpieczeństwa zgodny z przepisami normy VDE 0701 (Niemcy) lub odpowiednimi przepisami obowiązującymi w kraju użytkowania.

#### **Ryzyko zranienia o ostre krawędzie!**

- Używać rękawic ochronnych.

#### **Ryzyko zmiążdżenia podczas naprawy, obsługi lub diagnozy, ze względu na ciężkie i ruchome elementy**

- Stosować obuwie ochronne.
- Zabezpieczyć ciężkie elementy przed upadkiem.
- Nie dotykać ruchomych elementów podczas pracy urządzenia.



#### **Zagrożenie dla bezpieczeństwa użytkownika i działania urządzenia!**

- Używać tylko oryginalnych części zamiennych.

#### **Ryzyko uszkodzenia komponentów wrażliwych na wyładowania elektrostatyczne (ESD)!**

- Nie dotykać modułów, włącznie ze złączami i ścieżkami przewodzącymi.

## Narzędzia i pomoce techniczne

Przeznaczenie	Detale	Zdjęcia
Tkanina ochronna [00342013]	60 cm x 50 cm	
Przyssawka [00342224]	Ø50 mm	
Torx Bit TX20 [00340865]	6,3 mm (1/4")	

## 4.1 Wymiana uszczelki drzwiczek

### Warunek:

- ✔ Drzwiczki są otwarte.

### 4.1.1 Demontaż uszczelki drzwiczek

1. Poluzować uszczelkę drzwiczek w rowku w prawym i lewym narożniku.



2. Wyciągnąć uszczelkę drzwiczek z rowka.



- ➡ Uszczelka drzwiczek została zdemontowana.

### 4.1.2 Montaż uszczelki drzwiczek



Grubość nowej uszczelki drzwiczek może się nieco różnić od grubości starej uszczelki drzwiczek. Nie ma to wpływu na jakość zamykania drzwiczek i i działanie urządzenia.

Jeżeli urządzenie posiada regulowane zawiasy lub elementy mocujące zawiasów, można przy ich użyciu regulować sposób zamykania drzwiczek.

Małe boczne otwory w uszczelce drzwiczek są elementami funkcyjnymi (zapewniają wentylację). Nie stanowią one wad produkcyjnych.

1. Skontrolować rowek uszczelki pod kątem uszkodzeń.



4. Wcisnąć narożniki uszczelki do rowka u dołu i u góry.

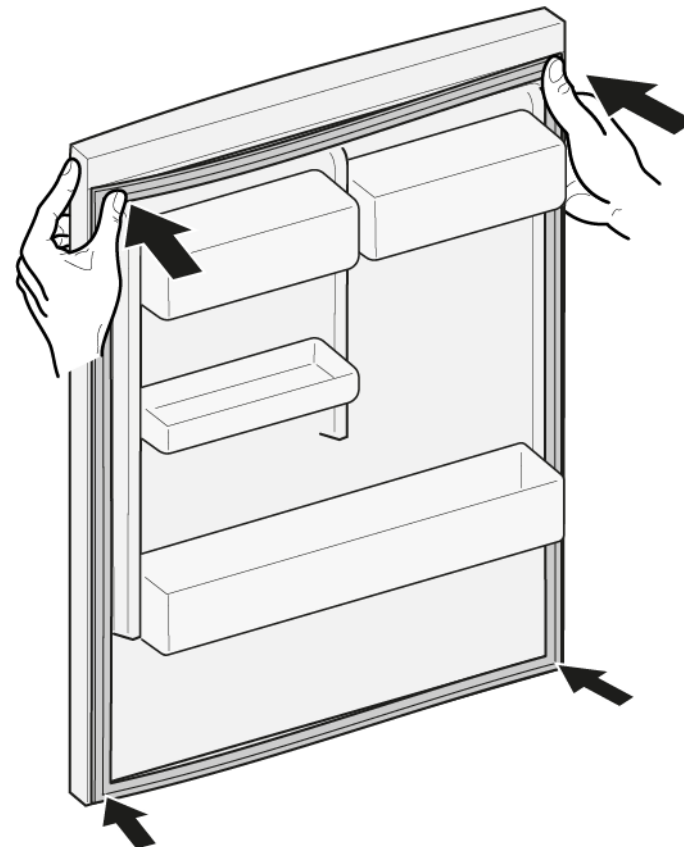

2.  Jeżeli rowek uszczelki jest uszkodzony.  
- Skontaktować się z serwisem.

3.  Lekka deformacja uszczelki drzwiczek jest normalna i nie wpływa na jej funkcję. Zaleca się wyprostowanie uszczelki drzwiczek przed jej zamocowaniem w urządzeniu.

Ogrzać uszczelkę drzwiczek suszarką do włosów lub nadać jej żądany kształt rękami.

5. Krok po kroku wcisnąć uszczelkę do rowka na całym obwodzie.



 Uszczelka drzwiczek została zamontowana.

## 4.2 Wymiana zawiasu płaskiego

### Pomoce specjalne

Torx Bit TX20

6,3 mm (1/4")

[00340865]



#### OSTRZEŻENIE

##### Ciężkie, nieporęczne urządzenia!

Kontuzje mięśni i pleców

- ▶ Czynność demontażu drzwiczek urządzenia powinna być wykonywana tylko przez wyszkolonych techników.
- ▶ Przemieszczenie urządzenia wymaga udziału dwóch osób.
- ▶ Używać tylko odpowiednich narzędzi i sprzętu.



#### WAŻNE

##### Ostre krawędzie!

Rany cięte

- ▶ Zawsze używaj rękawic ochronnych.



#### WAŻNE

##### Odstonięty zawias!

Zmiażdżenie / uwięzienie palca

- ▶ Nie wkładać rąk pod zawiasy.
- ▶ Zawsze używaj rękawic ochronnych.



#### WAŻNE

##### Niebezpieczeństwo spadnięcia części po wykręceniu śrub!

Zranienie przez spadające części.

- ▶ Zabezpieczyć część przed spadnięciem.



#### UWAGA!

##### Niebezpieczeństwo spadnięcia części po wykręceniu śrub!

Uszkodzenie innych części urządzenia albo pomieszczenia mieszkalnego, np. podłogi.

- ▶ Zabezpieczyć część przed spadnięciem.

### Warunek:

- ✔ Urządzenie jest odłączone od źródła zasilania energią elektryczną.
- ✔ Zostały wymontowane drzwiczki mebla. Patrz instrukcja montażu.
- ✔ Drzwiczki są otwarte.

## 4.2.1 Demontaż zawiasu płaskiego

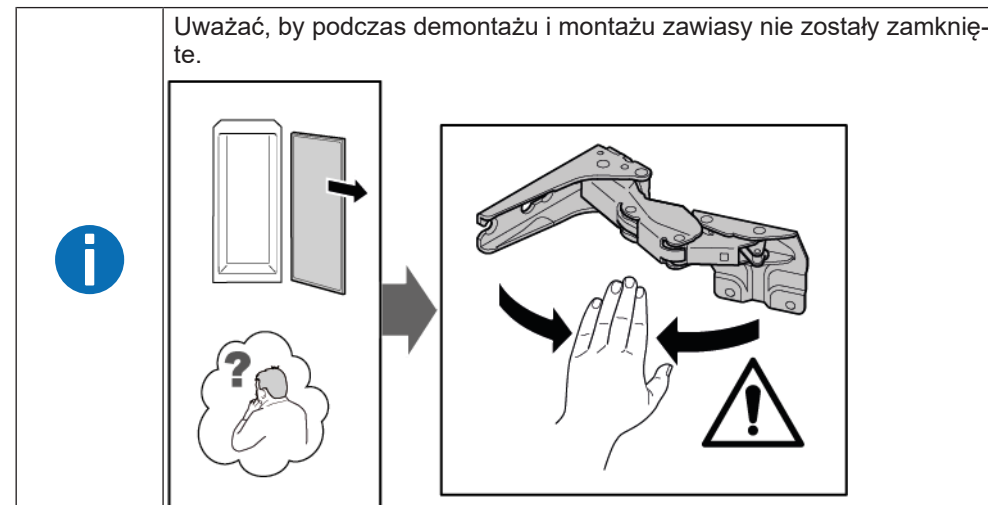

1. Wyjąć dwie osłony zawiasów.

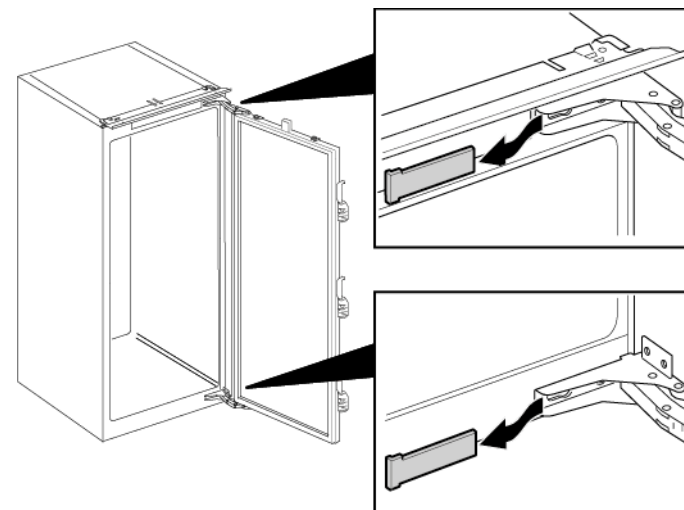

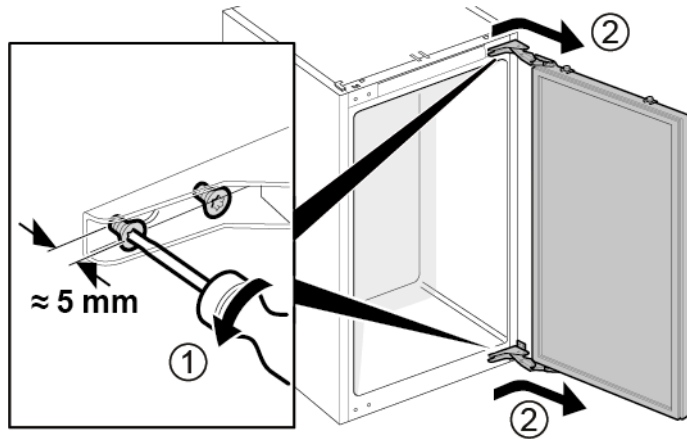

## Naprawy

2. 1. Poluzować cztery śruby (1).
2. Wysunąć i wyjąć drzwiczki (2).

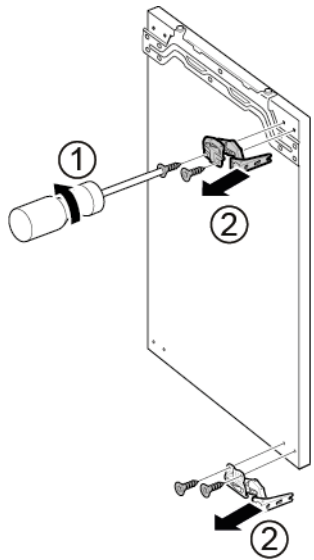

3. 1. Wykręcić cztery śruby (1).
2. Wyjąć zawiasy (2).



 Zawiasy są wymontowane.

### 4.2.2 Montaż zawiasu płaskiego

- ▶ Montaż w odwrotnej kolejności.

## 4.3 Wymiana zawiasu suwakowego

### Pomoce specjalne

Torx Bit TX20 6,3 mm (1/4") [00340865]

	<b>⚠ OSTRZEŻENIE</b>
	<p><b>Ciężkie, nieporęczne urządzenia!</b> Kontuzje mięśni i pleców</p> <ul style="list-style-type: none"> <li>▶ Czynność demontażu drzwiczek urządzenia powinna być wykonywana tylko przez wyszkolonych techników.</li> <li>▶ Przemieszczenie urządzenia wymaga udziału dwóch osób.</li> <li>▶ Używać tylko odpowiednich narzędzi i sprzętu.</li> </ul>

	<b>⚠ WAŻNE</b>
	<p><b>Ostre krawędzie!</b> Rany cięte</p> <ul style="list-style-type: none"> <li>▶ Zawsze używaj rękawic ochronnych.</li> </ul>

	<b>⚠ WAŻNE</b>
	<p><b>Niebezpieczeństwo spadnięcia części po wykręceniu śrub!</b> Zranienie przez spadające części.</p> <ul style="list-style-type: none"> <li>▶ Zabezpieczyć część przed spadnięciem.</li> </ul>

	<b>UWAGA!</b>
	<p><b>Niebezpieczeństwo spadnięcia części po wykręceniu śrub!</b> Uszkodzenie innych części urządzenia albo pomieszczenia mieszkalnego, np. podłogi.</p> <ul style="list-style-type: none"> <li>▶ Zabezpieczyć część przed spadnięciem.</li> </ul>

### Warunek:

- ✔ Urządzenie jest odłączone od źródła zasilania energią elektryczną.
- ✔ Drzwiczki mebla zostały odłączone od drzwiczek urządzenia. Patrz instrukcja montażu.

### 4.3.1 Demontaż zawiasu suwakowego

- ▶ 1. Wykręcić dwie śruby (1).
- ▶ 2. Wyjąć zawias górny (2).
- ▶ 3. Wyjąć drzwiczki (3).
- ▶ 4. Wykręcić dwie śruby (4).
- ▶ 5. Wyjąć zawias dolny (5).

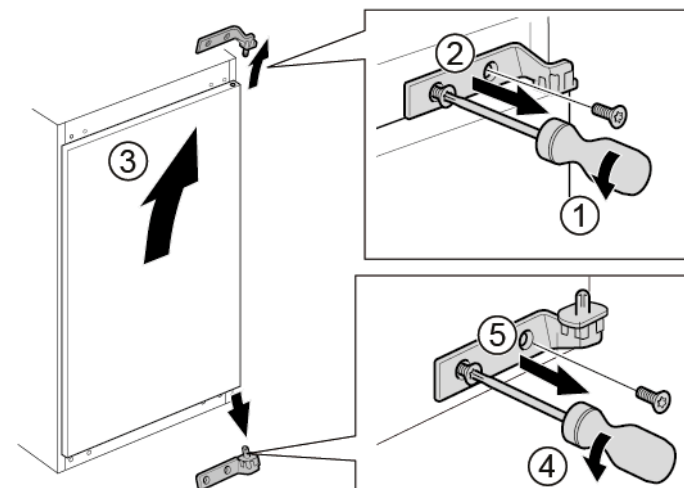

➡ Zawiasy są wymontowane.

### 4.3.2 Montaż zawiasu suwakowego

- ▶ Montaż w odwrotnej kolejności.



### 4.4 Wymiana półki

#### Warunek:

- ✔ Drzwiczki są otwarte.

#### 4.4.1 Demontaż półki

- ▶ Wyciągnąć półkę.

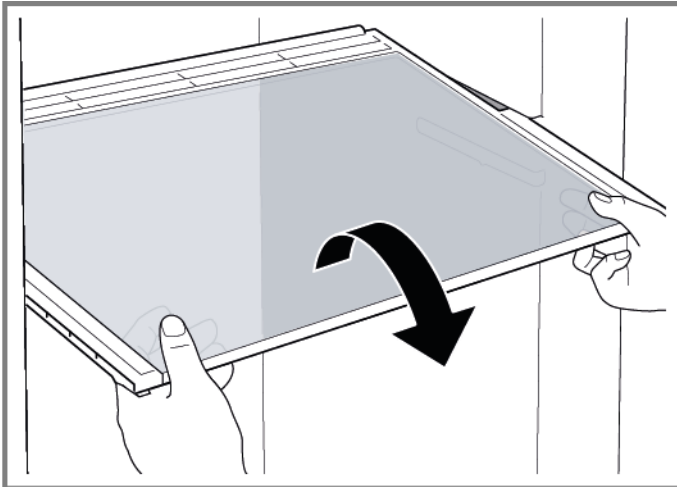

- ➡ Półka jest wyjęta.

#### 4.4.2 Montaż półki

- ▶ Montaż w odwrotnej kolejności.

## 4.5 Wymiana półki drzwiczek

### Warunek:

- ✔ Drzwiczki są otwarte.

### 4.5.1 Demontaż półki drzwiczek

- ▶ Podnieść półkę drzwiczek do góry.

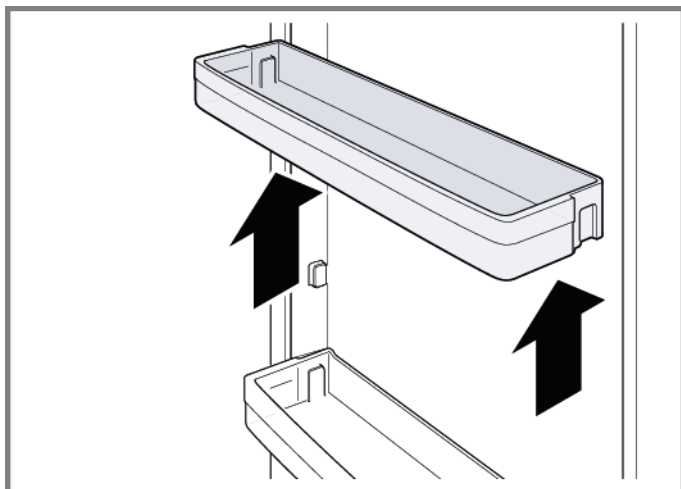

- ➡ Półka drzwiczek została zdemontowana.

### 4.5.2 Montaż półki drzwiczek

- ▶ Montaż w odwrotnej kolejności.

### 4.6 Wymiana pojemnika na owoce i warzywa

#### Warunek:

- ✔ Drzwiczki są otwarte.

#### 4.6.1 Demontaż pojemnika na owoce i warzywa

1. Wyciągnąć pojemnik na owoce i warzywa do oporu.
2. 1. Podnieść pojemnik na owoce i warzywa z przodu (1).  
2. Wyjąć pojemnik (2).

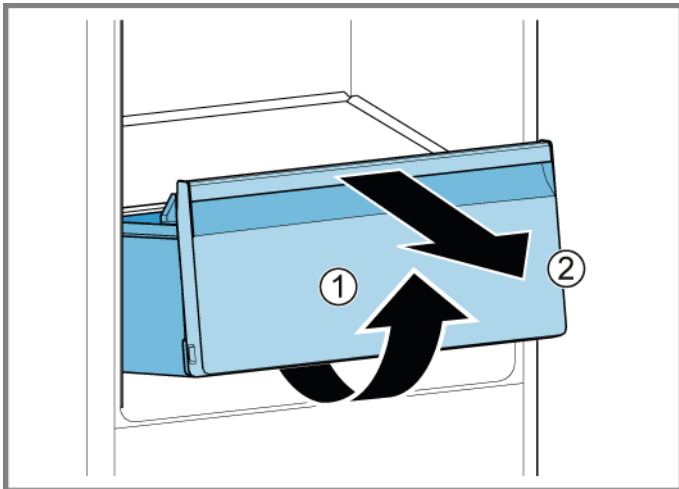

- ➔ Pojemnik na owoce i warzywa jest wyjęty.

#### 4.6.2 Montaż pojemnika na owoce i warzywa

- ▶ Montaż w odwrotnej kolejności.

## 4.7 Wymiana oświetlenia bocznego LED

### Pomoce specjalne

Przyssawka Ø50 mm [00342224]

**i** Urządzenie posiada bezobsługowe oświetlenie LED. Tego rodzaju elementy oświetleniowe mogą być naprawiane wyłącznie przez serwis lub autoryzowanych techników!

**⚠ NIEBEZPIECZEŃSTWO**  
**Ryzyko porażenia prądem elektrycznym wskutek kontaktu z elementami znajdującymi się pod napięciem!**  
 Niebezpieczeństwo utraty życia wskutek porażenia prądem elektrycznym w przypadku nieprawidłowej naprawy

- ▶ Części elektryczne powinny być naprawiane przez wykwalifikowanych elektryków.
- ▶ Po naprawie należy przeprowadzić test bezpieczeństwa zgodny z przepisami normy VDE 0701 (Niemcy) lub odpowiednimi przepisami obowiązującymi w kraju użytkowania.

**⚠ NIEBEZPIECZEŃSTWO**  
**Ryzyko porażenia prądem, ze względu na elementy będące pod napięciem!**  
 Zagrożenie życia poprzez porażenie prądem

- ▶ Odłączyć urządzenie od zasilania sieciowego na 60 sekund przed rozpoczęciem naprawy.

**⚠ WAŻNE**  
**Ostre krawędzie!**  
 Rany cięte

- ▶ Zawsze używaj rękawic ochronnych.

### Warunek:

- ✓ Urządzenie jest odłączone od źródła zasilania energią elektryczną.
- ✓ Drzwiczki są otwarte.
- ✓ Zostały wyjęte półki.

### 4.7.1 Demontaż oświetlenia bocznego LED

1. Przymocować przyssawkę do pokrywy bocznego oświetlenia LED.

2. Pociągnąć przyssawkę do przodu jednym obrotowym ruchem.

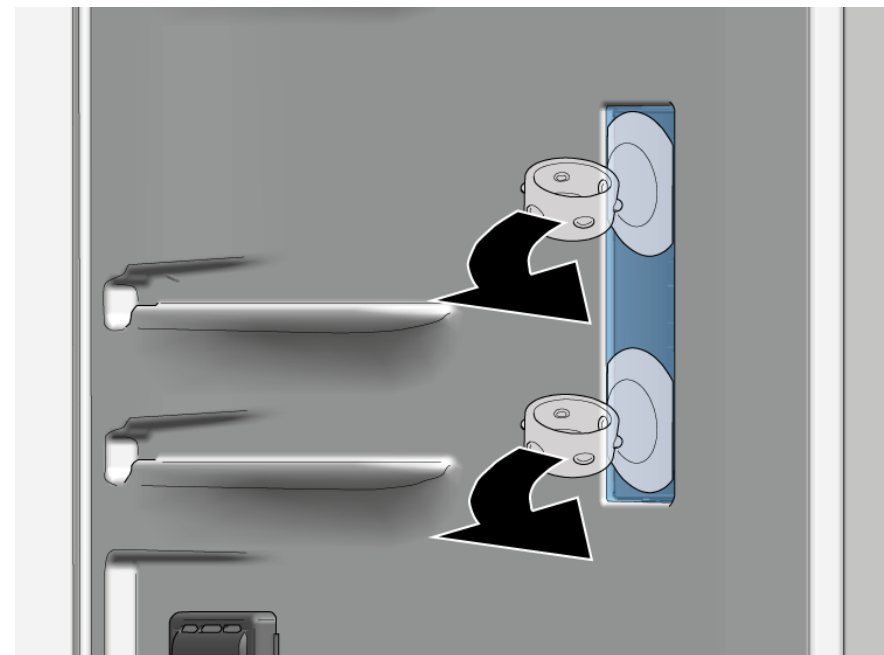

➡ Pokrywa oświetlenia LED została wymontowana.

3. Zdemontować moduł LED.



 Boczne oświetlenie LED zostało wymontowane.

### 4.7.2 Montaż bocznego oświetlenia LED



Ze względu na to, że zaczepy pokrywy łatwo się łamią, część zamienna oświetlenie boczne LED stanowi zestaw zawierający moduł LED i pokrywę.

- ▶ Montaż w odwrotnej kolejności.

# Dicas de resolução - Frigorífico

 <b>Sobre este documento</b> .....	<b>275</b>
1.1 Informação importante .....	275
1.1.1 Finalidade.....	275
1.2 Explicação dos símbolos.....	275
1.2.1 Níveis de perigo.....	275
1.2.2 Símbolos de perigo .....	275
1.2.3 Estrutura dos avisos.....	276
1.2.4 Símbolos gerais .....	276
 <b>Segurança</b> .....	<b>277</b>
2.1 Instruções gerais de segurança.....	277
2.1.1 Todos os eletrodomésticos .....	277
 <b>Ferramentas e auxiliares</b> .....	<b>278</b>
 <b>Reparação</b> .....	<b>279</b>
4.1 Substituir a junta da porta .....	279
4.1.1 Remover a junta da porta .....	279
4.1.2 Instalar a junta da porta.....	279
4.2 Substituir a dobradiça plana .....	282
4.2.1 Remover a dobradiça plana.....	282
4.2.2 Instalar a dobradiça plana .....	283
4.3 Substituir a dobradiça deslizante .....	284
4.3.1 Remover a dobradiça deslizante .....	284
4.3.2 Instalar a dobradiça deslizante.....	284
4.4 Substituir a prateleira .....	285
4.4.1 Remover a prateleira.....	285
4.4.2 Instalar a prateleira .....	285
4.5 Substituir a prateleira da porta.....	286
4.5.1 Remover a prateleira da porta.....	286
4.5.2 Instalar a prateleira da porta .....	286
4.6 Substituir o recipiente para fruta e vegetais.....	287
4.6.1 Remover o recipiente para fruta e vegetais.....	287
4.6.2 Instalar o recipiente para fruta e vegetais .....	287
4.7 Substituir a iluminação LED lateral .....	288
4.7.1 Remover a iluminação LED lateral .....	288
4.7.2 Instalar a iluminação LED lateral.....	289

# **i** Sobre este documento

## 1.1 Informação importante

### 1.1.1 Finalidade

Estas dicas de reparação auxiliam o consumidor na reparação de aparelhos por ele próprio de acordo com o regulamento de "Eco-design" aplicável (a partir de 03/2021).

Estas contêm informações sobre como substituir peças sobressalentes definidas, incluindo avisos e riscos.

Em caso de dúvidas, entre em contacto com o nosso serviço de apoio ao cliente. Apenas nos responsabilizaremos por danos se as dicas de reparação tiverem sido devidamente seguidas.

## 1.2 Explicação dos símbolos

### 1.2.1 Níveis de perigo

Os níveis de aviso são compostos por um símbolo e uma palavra sinal. A palavra-sinal indica a gravidade do perigo.









Nível de aviso	Significado
	A não observância da mensagem de aviso resulta em morte ou ferimentos graves.
	A não observância da mensagem de aviso pode resultar em morte ou ferimentos graves.
	A não observância da mensagem de aviso pode resultar em ferimentos ligeiros.
	A não observância da mensagem de aviso pode resultar em danos materiais.

Tabela 1: Níveis de perigo

### 1.2.2 Símbolos de perigo

Os símbolos de perigo são representações simbólicas que dão uma indicação do tipo de perigo.

Neste documento são utilizados os seguintes símbolos de perigo:

Símbolo de perigo	Significado
	Mensagem geral de aviso
	Perigo de tensão elétrica
	Risco de explosão
	Perigo de cortes

## **i** Sobre este documento





Símbolo de perigo	Significado
	Perigo de esmagamento
	Perigo de superfícies quentes
	Perigo de campo eletromagnético intenso
	Perigo de radiação não-ionizante

Tabela 2: Símbolos de perigo

### 1.2.3 Estrutura dos avisos

Os avisos neste documento possuem um aspeto normalizado e uma estrutura normalizada.

	<b>⚠ PERIGO</b>
<b>Tipo e origem do perigo!</b>	
Possíveis consequência de ignorar o perigo / aviso.	
▶ Medidas e proibições para prevenir o perigo.	

O seguinte exemplo mostra um aviso que adverte contra choques elétricos devido a partes sob tensão. A medida para evitar o perigo é mencionada.

	<b>⚠ PERIGO</b>
<b>Risco de choque elétrico devido a partes sob tensão!</b>	
Morte por eletrocussão	
▶ Desligue os aparelhos da alimentação elétrica pelo menos 60 segundos antes de iniciar as reparações.	

### 1.2.4 Símbolos gerais

Neste documento são utilizados os seguintes símbolos gerais:







Símbolo ger.	Significado
	Identificação de uma dica especial (texto e/ou ilustração)
	Identificação de uma dica simples (apenas texto)
	Identificação de uma ligação para um tutorial em vídeo
	Identificação das ferramentas necessárias
	Identificação das condições prévias necessárias
	Identificação de uma condição (se ..., então ...)
	Identificação de um resultado
Iniciar	Identificação de uma tecla ou botão
[00123456]	Identificação de um número de material
Estado	Identificação de um texto exibido / janela (no visor do aparelho)

Tabela 3: Símbolos gerais



## 2.1 Instruções gerais de segurança

### 2.1.1 Todos os eletrodomésticos

#### **Risco de choque elétrico devido a partes sob tensão!**

- Erros por reparações envolvendo componentes elétricos podem provocar choques elétricos!
- Desligue o aparelho da rede elétrica pelo menos 60 segundos antes de iniciar o trabalho.
- Após a reparação, solicite a realização de um teste de segurança de acordo com VDE 0701 ou os regulamentos específicos do país.

#### **Risco de ferimentos causados por arestas vivas!**

- Use luvas de proteção.

#### **Risco de esmagamento durante trabalhos de reparação, manutenção, resolução de problemas e serviço devido a componentes pesados e móveis**

- Use calçado de proteção.
- Proteja os componentes pesados contra quedas.
- Não introduzir partes do corpo em componentes móveis.



#### **Risco para a segurança/funcionamento do aparelho!**

- Utilize apenas peças sobressalentes originais.

#### **Risco de danos em componentes electrostaticamente sensíveis (ESDs)!**

- Não toque nos módulos, incluindo ligações e percursos condutores.

## Ferramentas e auxiliares

Designação	Detalhes	Imagens
Pano protetor [00342013]	60 cm x 50 cm	
Ventosa [00342224]	Ø50 mm	
Ponta Torx TX20 [00340865]	6,3 mm (1/4")	

## 4.1 Substituir a junta da porta

### Pré-requisito:

- ✔ A porta está aberta.

### 4.1.1 Remover a junta da porta

1. Solte a junta da porta da ranhura nos cantos direito e esquerdo.



2. Puxe a junta da porta para fora da ranhura.



- ➡ A junta da porta está removida.

### 4.1.2 Instalar a junta da porta



A espessura da nova junta da porta pode divergir ligeiramente da da junta antiga da porta. Isto não afetará o comportamento de fecho nem o funcionamento a longo termo.

Se o seu aparelho dispor de dobradiças ou fixações de dobradiça ajustáveis, poderá otimizar o comportamento de fecho subseqüentemente.

Os pequenos orifícios laterais na junta da porta são funcionais (necessários à ventilação). Não se trata de falhas de produção.

## Reparação

1. Verifique se a ranhura para a junta apresenta danos.

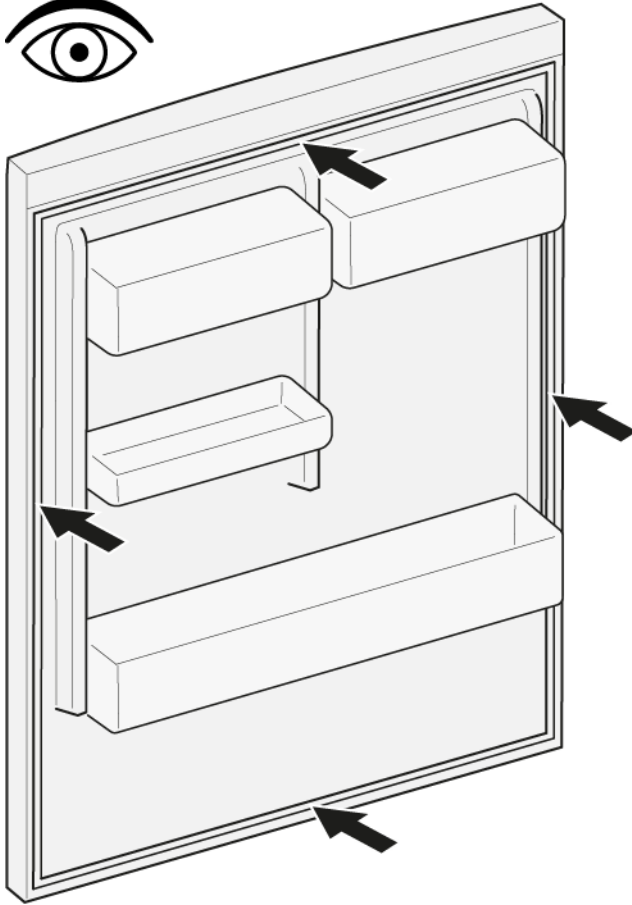

4. Empurre os cantos da junta em cima e em baixo para ranhura.

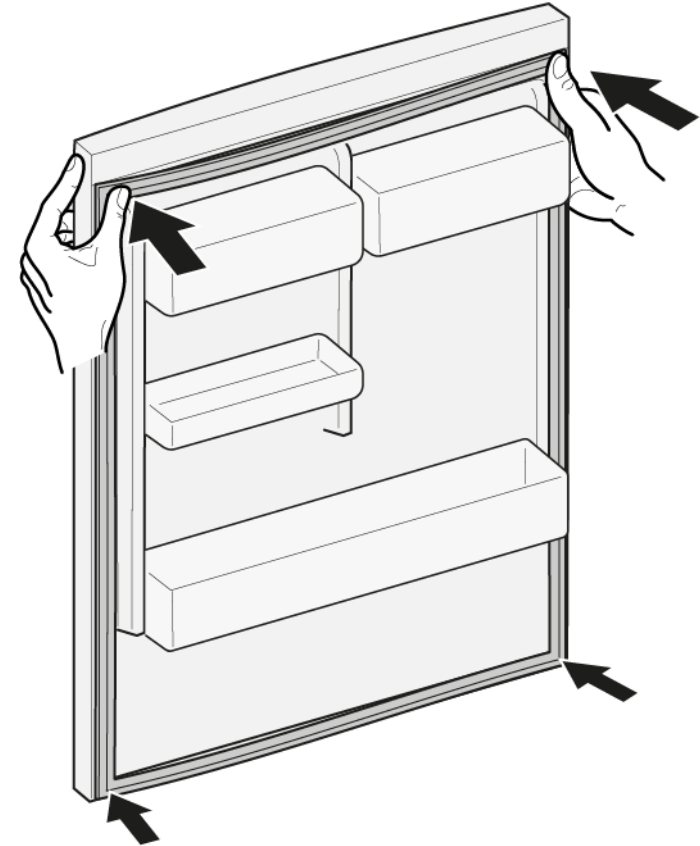

2.  Se a ranhura para a junta estiver danificada,  
- contacte o serviço de apoio ao consumidor.

3.  Uma deformação ligeira da junta da porta é normal e não afeta o seu funcionamento. Recomenda-se que a junta da porta seja endireitada antes de ser inserida no aparelho.

Aqueça a junta da porta com a um secador de cabelo ou água quente e mude a sua forma manualmente.

## Reparação

5. Pressione a junta inteira gradualmente para dentro da ranhura.





-  A junta da porta está instalada.

## 4.2 Substituir a dobradiça plana

### Ferramentas necessárias:

🔧 Ponta Torx TX20      6,3 mm (1/4")      [00340865]

	<b>⚠️ AVISO</b>
	<b>Aparelhos pesados e volumosos!</b> Lesões nas costas e musculares <ul style="list-style-type: none"><li>▶ A operação de remoção da porta do aparelho deve ser apenas executada por especialistas formados.</li><li>▶ São necessárias duas pessoas para mover o aparelho.</li><li>▶ Use apenas ferramentas e equipamento adequados.</li></ul>

	<b>⚠️ CUIDADO</b>
	<b>Arestas vivas!</b> Lesões por corte <ul style="list-style-type: none"><li>▶ Use luvas de proteção.</li></ul>

	<b>⚠️ CUIDADO</b>
	<b>Zona das dobradiças aberta!</b> Esmagamento / entalamento dos dedos <ul style="list-style-type: none"><li>▶ Não coloque as mãos na zona das dobradiças.</li><li>▶ Use luvas de proteção.</li></ul>

	<b>⚠️ CUIDADO</b>
	<b>Risco de queda de peças devido a parafusos desapertados!</b> Lesões devido à queda de peças. <ul style="list-style-type: none"><li>▶ Proteja o componente contra as quedas.</li></ul>

	<b>ATENÇÃO!</b>
	<b>Risco de queda de peças devido a parafusos desapertados!</b> Danos em outros componentes do aparelho ou na casa do cliente, p. ex., no pavimento. <ul style="list-style-type: none"><li>▶ Proteja o componente contra as quedas.</li></ul>

### Pré-requisito:

- ✔ O aparelho está desligado da alimentação elétrica.
- ✔ A porta do móvel está removida. Ver as instruções de instalação.
- ✔ A porta está aberta.

## 4.2.1 Remover a dobradiça plana

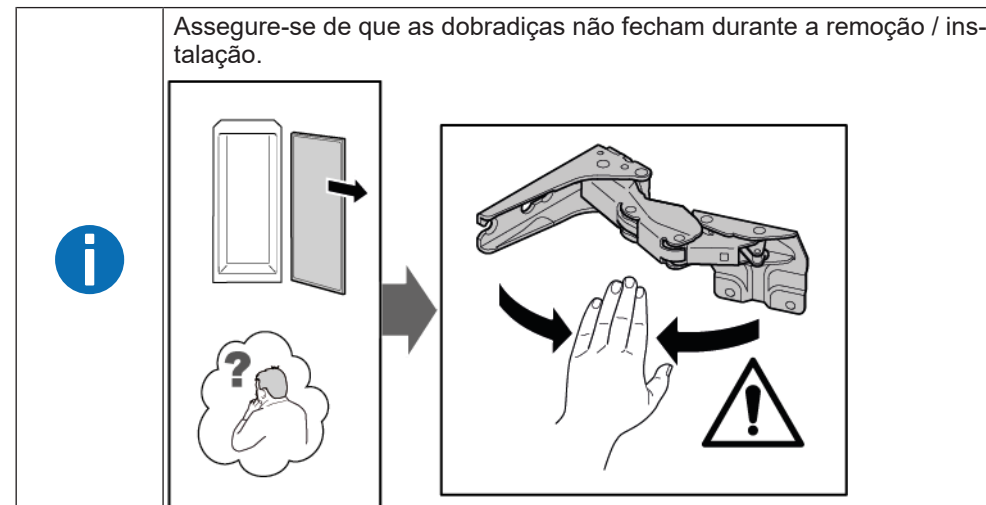

1. Remova duas tampas de dobradiça.

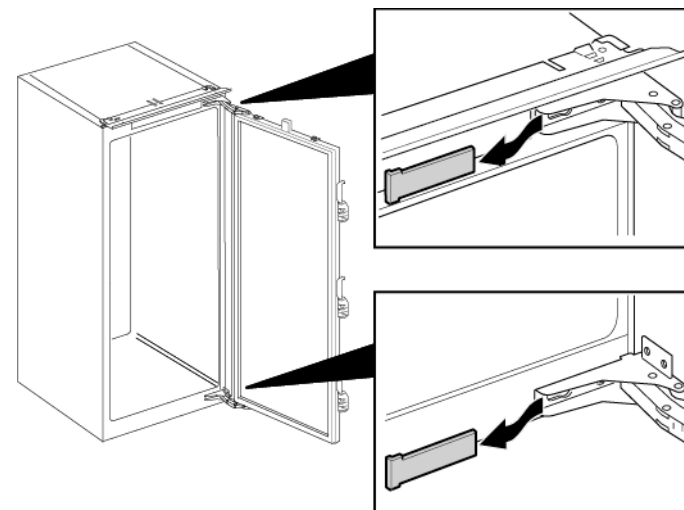



## Reparação

2. 1. Solte quatro parafusos (1).
2. Deslize para fora e remova a porta (2).

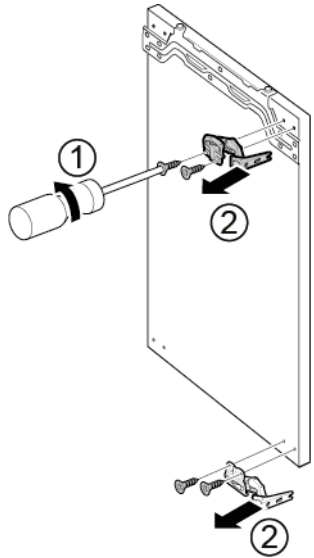

3. 1. Remova quatro parafusos (1).
2. Remova as dobradiças (2).



 As dobradiças estão removidas.

### 4.2.2 Instalar a dobradiça plana

- ▶ Instale pela ordem inversa.

## 4.3 Substituir a dobradiça deslizante

### Ferramentas necessárias:

🌀 Ponta Torx TX20      6,3 mm (1/4")      [00340865]

	<b>⚠️ AVISO</b>
	<b>Aparelhos pesados e volumosos!</b> Lesões nas costas e musculares <ul style="list-style-type: none"><li>▶ A operação de remoção da porta do aparelho deve ser apenas executada por especialistas formados.</li><li>▶ São necessárias duas pessoas para mover o aparelho.</li><li>▶ Use apenas ferramentas e equipamento adequados.</li></ul>

	<b>⚠️ CUIDADO</b>
	<b>Arestas vivas!</b> Lesões por corte <ul style="list-style-type: none"><li>▶ Use luvas de proteção.</li></ul>

	<b>⚠️ CUIDADO</b>
	<b>Risco de queda de peças devido a parafusos desapertados!</b> Lesões devido à queda de peças. <ul style="list-style-type: none"><li>▶ Proteja o componente contra as quedas.</li></ul>

	<b>ATENÇÃO!</b>
	<b>Risco de queda de peças devido a parafusos desapertados!</b> Danos em outros componentes do aparelho ou na casa do cliente, p. ex., no pavimento. <ul style="list-style-type: none"><li>▶ Proteja o componente contra as quedas.</li></ul>

### Pré-requisito:

- ✔ O aparelho está desligado da alimentação elétrica.
- ✔ A porta do móvel e a porta do aparelho estão separadas. Ver as instruções de instalação.

### 4.3.1 Remover a dobradiça deslizante

- ▶ 1. Desaperte dois parafusos (1).
- ▶ 2. Remova a dobradiça superior (2).
- ▶ 3. Remova a porta (3).
- ▶ 4. Desaperte dois parafusos (4).
- ▶ 5. Remova a dobradiça inferior (5).

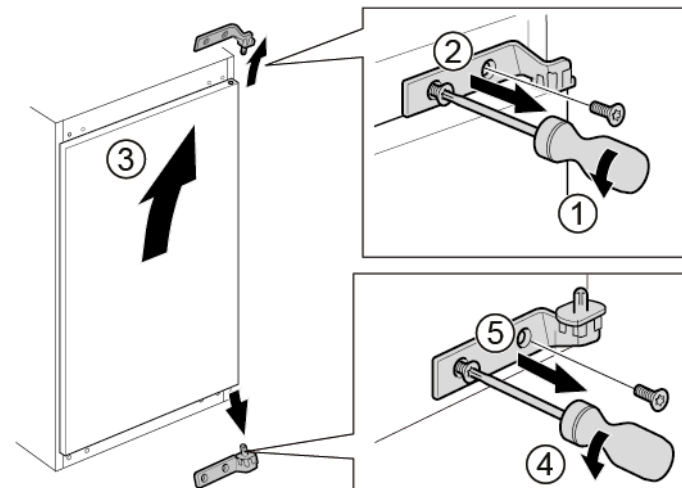

➡ As dobradiças estão removidas.

### 4.3.2 Instalar a dobradiça deslizante

- ▶ Instale pela ordem inversa.



## 4.4 Substituir a prateleira

Pré-requisito:

- ✔ A porta está aberta.

### 4.4.1 Remover a prateleira

- ▶ Puxe a prateleira para fora.

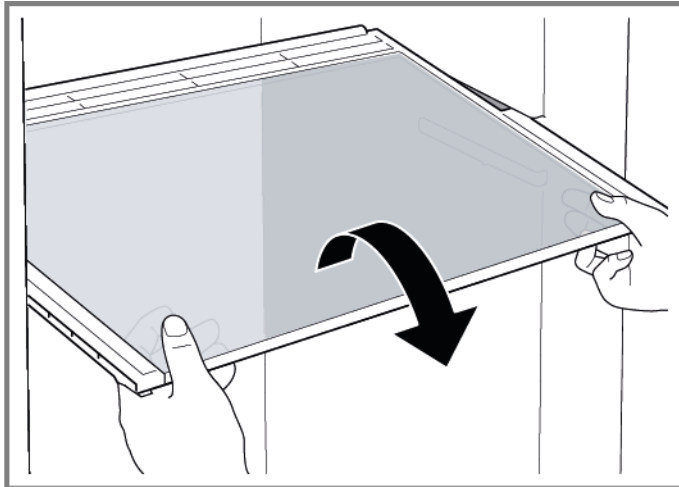

➡ A prateleira está removida.

### 4.4.2 Instalar a prateleira

- ▶ Instale pela ordem inversa.

## 4.5 Substituir a prateleira da porta

Pré-requisito:

- ✔ A porta está aberta.

### 4.5.1 Remover a prateleira da porta

- ▶ Levante a prateleira da porta.

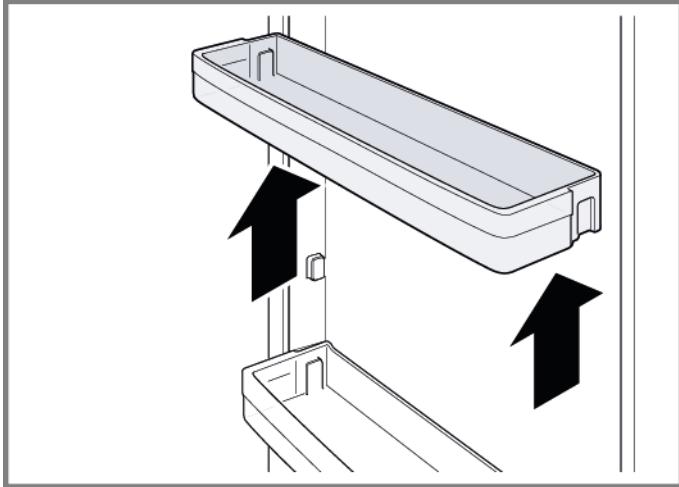

➡ A prateleira da porta está removida.

### 4.5.2 Instalar a prateleira da porta

- ▶ Instale pela ordem inversa.

### 4.6 Substituir o recipiente para fruta e vegetais

#### Pré-requisito:

- ✔ A porta está aberta.

#### 4.6.1 Remover o recipiente para fruta e vegetais

1. Puxe o recipiente para fruta e vegetais para fora até ao máximo.
2. 1. Levante o recipiente para fruta e vegetais à frente (1).  
2. Remova o recipiente (2).



- ➔ O recipiente para fruta e vegetais está removido.

#### 4.6.2 Instalar o recipiente para fruta e vegetais

- ▶ Instale pela ordem inversa.

## 4.7 Substituir a iluminação LED lateral

### Ferramentas necessárias:

Ventosa Ø50 mm [00342224]



O seu aparelho dispõe de uma iluminação LED isenta de manutenção. Estas iluminações só podem ser reparadas pelo serviço de apoio ao consumidor ou por técnicos autorizados!



### PERIGO

#### Risco de choque elétrico devido a partes sob tensão!

Risco de vida devido a choque elétrico em caso de reparação inadequada

- ▶ As partes elétricas devem ser reparadas por um electricista qualificado.
- ▶ Após a reparação, solicite a realização de um teste de segurança de acordo com VDE 0701 ou os regulamentos específicos do país.



### PERIGO

#### Risco de choque elétrico devido a partes sob tensão!

Morte por eletrocussão

- ▶ Desligue os aparelhos da alimentação elétrica pelo menos 60 segundos antes de iniciar as reparações.



### CUIDADO

#### Arestas vivas!

Lesões por corte

- ▶ Use luvas de proteção.

### Pré-requisito:

- ✓ O aparelho está desligado da alimentação elétrica.
- ✓ A porta está aberta.
- ✓ As prateleiras estão removidas.

### 4.7.1 Remover a iluminação LED lateral

1. Coloque duas ventosas na tampa da iluminação LED lateral.

2. Puxe as ventosas para a frente num movimento rotativo.

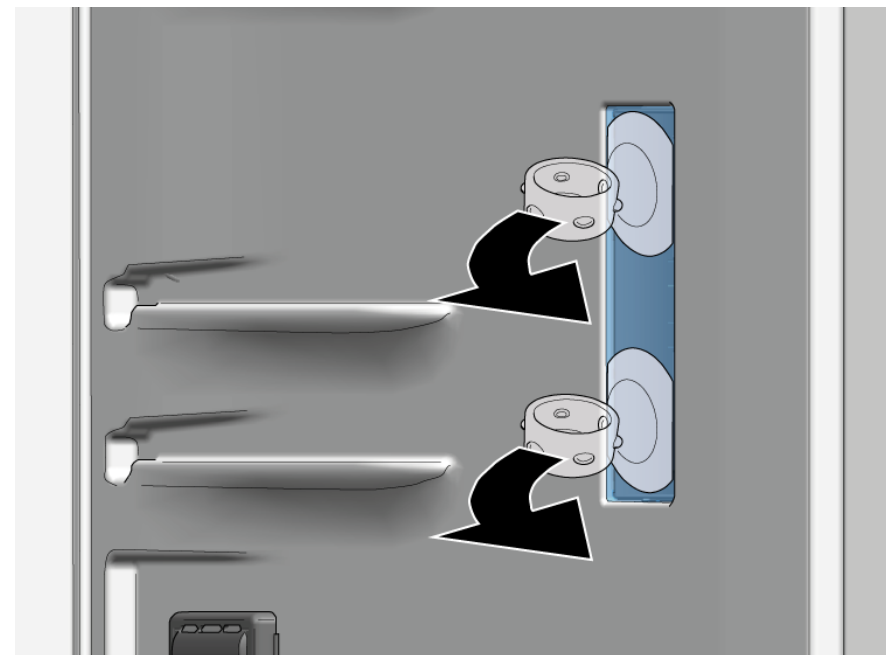

- ➡ A tampa da iluminação LED está removida.

## Reparação

3. Remova o módulo LED.



 A iluminação LED lateral está removida.

### 4.7.2 Instalar a iluminação LED lateral



Uma vez que os ganchos da tampa da lâmpada quebram facilmente durante o processo de remoção a iluminação LED lateral sobressalente é um conjunto que inclui o módulo LED e a tampa da iluminação.

► Instale pela ordem inversa.

# Indicii pentru reparații - Frigider

 <b>Referitor la acest document.....</b>	<b>291</b>
1.1 Informații importante .....	291
1.1.1 Aplicabilitatea .....	291
1.2 Explicația simbolurilor .....	291
1.2.1 Nivelurile de pericol.....	291
1.2.2 Simbolurile de pericol.....	291
1.2.3 Structura avertismentelor.....	292
1.2.4 Simbolurile generale .....	292
 <b>Siguranța.....</b>	<b>293</b>
2.1 Instrucțiuni generale de siguranță.....	293
2.1.1 Toate aparatele electrocasnice .....	293
 <b>Instrumente și materiale utile.....</b>	<b>294</b>
 <b>Repararea.....</b>	<b>295</b>
4.1 Înlocuirea garniturii ușii .....	295
4.1.1 Demontarea garniturii ușii.....	295
4.1.2 Montarea garniturii ușii .....	295
4.2 Înlocuirea balamalei plate.....	298
4.2.1 Demontarea balamalei plate .....	298
4.2.2 Montarea balamalei plate .....	299
4.3 Înlocuirea balamalei glisante .....	300
4.3.1 Demontarea balamalei glisante.....	300
4.3.2 Montarea balamalei glisante .....	300
4.4 Repoziționarea raftului .....	301
4.4.1 Demontarea raftului.....	301
4.4.2 Montarea raftului .....	301
4.5 Repoziționarea raftului pentru ușă .....	302
4.5.1 Demontarea raftului pentru ușă.....	302
4.5.2 Montarea raftului pentru ușă .....	302
4.6 Repoziționarea containerului pentru fructe și legume .....	303
4.6.1 Demontarea containerului pentru fructe și legume.....	303
4.6.2 Montarea containerului pentru fructe și legume .....	303
4.7 Înlocuirea lămpii LED laterale .....	304
4.7.1 Demontarea lămpii LED laterale.....	304
4.7.2 Montarea lămpii LED laterale .....	305

# **i** Referitor la acest document

## 1.1 Informații importante

### 1.1.1 Aplicabilitatea

Aceste instrucțiuni de reparare îl ajută pe client să își repare singur aparatele, în conformitate cu normele de proiectare ecologică aplicabile (începând cu 03/2021).





Acestea conțin informații privind modul de înlocuire a pieselor de schimb specifice, inclusiv avertismente și pericole.

Dacă aveți întrebări, vă rugăm să luați legătura cu serviciul relații clienți. Ne asumăm răspunderea pentru daune numai dacă instrucțiunile de reparare au fost respectate pe deplin.

## 1.2 Explicația simbolurilor

### 1.2.1 Nivelurile de pericol

Nivelurile de alertă sunt reprezentate printr-un simbol și un cuvânt de avertizare. Cuvântul de avertizare indică gravitatea pericolului.





Nivelul de alertă	Semnificație
 <b>PERICOL</b>	Nerespectarea mesajului de avertizare va provoca accidente grave sau decesul.
 <b>AVERTISMENT</b>	Nerespectarea mesajului de avertizare ar putea provoca accidente grave sau decesul.
 <b>ATENȚIONARE</b>	Nerespectarea mesajului de avertizare ar putea provoca accidente ușoare.
 <b>ATENȚIE!</b>	Nerespectarea mesajului de avertizare ar putea provoca daune asupra proprietății.

Tabel 1: Nivelurile de pericol



### 1.2.2 Simbolurile de pericol

Simbolurile de pericol sunt reprezentări simbolice care indică tipul de pericol.

În acest document sunt utilizate simbolurile de pericol de mai jos:

Simbol de pericol	Semnificație
	Mesaj de avertizare general
	Pericol din cauza tensiunii electrice
	Pericol de explozie
	Pericol de tăiere
	Pericol de zdrobire



## Referitor la acest document

Simbol de pericol	Semnificație
	Pericol din cauza suprafețelor fierbinți
	Pericol din cauza câmpului magnetic puternic
	Pericol din cauza radiației neionizante

Tabel 2: Simbolurile de pericol

### 1.2.3 Structura avertismentelor

Avertismentele din acest document au un aspect și o structură standard.



	<div style="background-color: red; color: white; padding: 2px; text-align: center;"> <b>PERICOL</b></div> <p><b>Tipul și sursa pericolului!</b> Consecințele posibile ale ignorării pericolului/avertismentului.</p> <ul style="list-style-type: none"> <li>▶ Măsuri și interdicții pentru prevenirea pericolului.</li> </ul>
--	--





Exemplul următor prezintă un avertisment privind electrocutarea din cauza pieselor sub tensiune. Se menționează măsura necesară pentru a evita pericolul.

	<div style="background-color: red; color: white; padding: 2px; text-align: center;"> <b>PERICOL</b></div> <p><b>Pericol de electrocutare din cauza pieselor sub tensiune!</b> Deces prin electrocutare</p> <ul style="list-style-type: none"> <li>▶ Deconectați aparatele de la sursa de alimentare cu tensiune cu cel puțin 60 de secunde înainte de a începe reparațiile.</li> </ul>
---	---

### 1.2.4 Simbolurile generale

În acest document sunt utilizate simbolurile generale de mai jos:

Simbol general	Semnificație
	Identificarea unei recomandări speciale (text și/sau grafică)
	Identificarea unei recomandări simple (numai text)

Simbol general	Semnificație
	Identificarea unui link spre un videoclip instructiv
	Identificarea sculelor necesare
	Identificarea condițiilor preliminare necesare
	Identificarea unei stări (dacă..., apoi...)
	Identificarea unui rezultat
[Pornire]	Identificarea unei taste sau a unui buton
[00123456]	Identificarea unui număr de serie
Stare	Identificarea unui text/unei ferestre afișate (pe ecranul aparatului)

Tabel 3: Simbolurile generale



## 2.1 Instrucțiuni generale de siguranță

### 2.1.1 Toate aparatele electrocasnice

#### **Pericol de electrocutare din cauza pieselor sub tensiune!**

- Erorile care au loc în timpul reparațiilor efectuate la componentele electrice pot să ducă la electrocutări!
- Deconectați aparatul de la sursa de alimentare cu tensiune cu cel puțin 60 de secunde înainte de a începe lucrările.
- După reparație, este obligatorie efectuarea unei verificări de siguranță conform cu VDE 0701 sau cu reglementările naționale respective.

#### **Pericol de rănire din cauza muchiilor ascuțite!**

- Purtați mănuși de protecție.

#### **Pericol de zdrobire în timpul lucrărilor de reparație, întreținere, depanare și service, din cauza componentelor grele și mobile**

- Purtați încălțăminte de protecție.
- Fixați componentele grele împotriva căderii.
- Nu vă sprijiniți cu părți ale corpului de componentele mobile.



#### **Pericol pentru siguranța/funcționarea aparatului!**

- Utilizați numai piese de schimb originale.

#### **Pericol de deteriorare a componentelor sensibile la electricitatea statică (ESD)!**

- Nu atingeți modulele, inclusiv conexiunile și căile conductorilor.

## Instrumente și materiale utile

Desemnare	Detalii	Imagini
Material textil de protecție [00342013]	60 cm x 50 cm	
Ventuză [00342224]	Ø50 mm	
Cap torx TX20 [00340865]	6,3 mm (1/4")	

## 4.1 Înlocuirea garniturii ușii

### Cerință:

-  Ușa este deschisă.

### 4.1.1 Demontarea garniturii ușii

1. Îndepărtați garnitura ușii din canelura colțurilor din dreapta și stânga.



2. Demontați garnitura ușii din canelură.



-  Garnitura ușii este demontată.

### 4.1.2 Montarea garniturii ușii



Grosimea garniturii noi a ușii poate fi ușor diferită față de grosimea garniturii vechi a ușii. Acest lucru nu va afecta comportamentul de închidere și funcționarea pe termen lung.

Dacă aparatul dumneavoastră are balamale reglabile sau accesorii pentru balamale, puteți optimiza comportamentul de închidere în consecință.

Orificiile de mici dimensiuni practicate în garnitura ușii au rol funcțional (sunt necesare pentru ventilație). Ele nu sunt defecte ale produsului.

## Repararea

1. Verificați canelura pentru montarea garniturii și asigurați-vă că nu prezintă defecte.



4. Împingeți colțurile de sus și de jos ale garniturii în canelură.

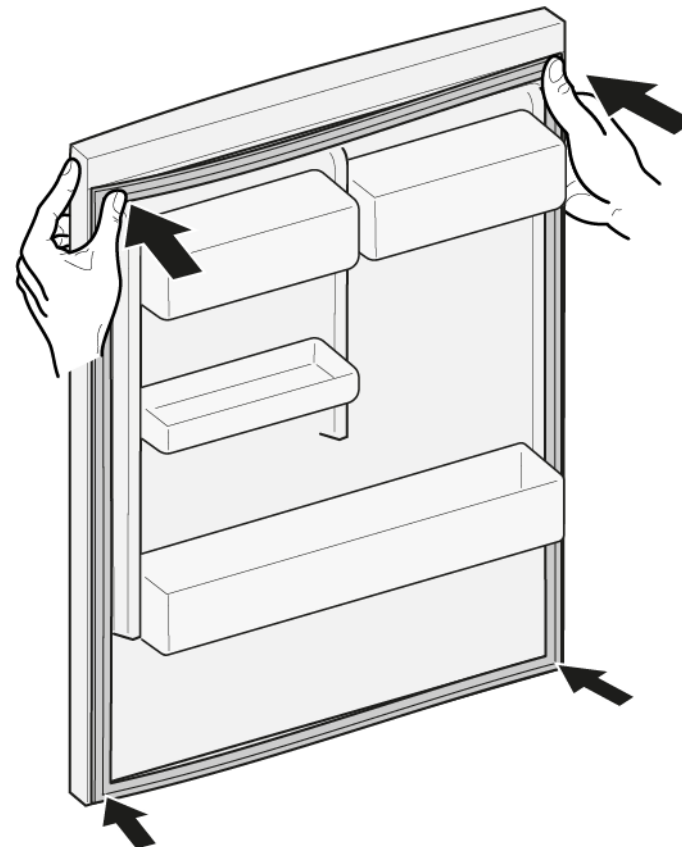

2.  Dacă canelura pentru montarea garniturii prezintă defecte, este deteriorată.  
- Contactați departamentul de service pentru clienți.

3.  O deformare ușoară a garniturii ușii este normală și nu afectează funcționarea acesteia. Se recomandă să îndreptați garnitura ușii înainte de a o introduce în aparat.

Încălziți garnitura ușii cu un uscător de păr sau cu apă fierbinte și remodelați-o cu mâna.

## Repararea

5. Apăsați întreaga garnitură în canelură, pas cu pas.



 Garnitura ușii este montată.





## 4.2 Înlocuirea balamalei plate

### Scule speciale:

Cap torx TX20

6,3 mm (1/4")

[00340865]

	<p><b>AVERTISMENT</b></p> <p><b>Aparate grele, masive!</b> Accidentarea spatelui și leziuni musculare</p> <ul style="list-style-type: none"> <li>▶ Operația de demontare a ușii aparatului trebuie efectuată numai de specialiști instruiți.</li> <li>▶ Pentru deplasarea aparatului sunt necesare două persoane.</li> <li>▶ Utilizați numai instrumente și echipamente adecvate.</li> </ul>
	<p><b>ATENȚIONARE</b></p> <p><b>Marginea ascuțită!</b> Rănire prin tăiere</p> <ul style="list-style-type: none"> <li>▶ Purtați mănuși de protecție.</li> </ul>
	<p><b>ATENȚIONARE</b></p> <p><b>Zona balamalei deschise!</b> Zdrobirea/prinderea degetelor</p> <ul style="list-style-type: none"> <li>▶ Nu introduceți degetele sau mâna în zona balamalei.</li> <li>▶ Purtați mănuși de protecție.</li> </ul>
	<p><b>ATENȚIONARE</b></p> <p><b>Pericol din cauza pieselor care cad pentru că șuruburile sunt slăbite!</b> Accidente din cauza pieselor care cad.</p> <ul style="list-style-type: none"> <li>▶ Fixați componenta împotriva căderii.</li> </ul>
	<p><b>ATENȚIE!</b></p> <p><b>Pericol din cauza pieselor care cad pentru că șuruburile sunt slăbite!</b> Deteriorarea altor piese ale aparatului sau a casei clientului, de exemplu, partea de jos.</p> <ul style="list-style-type: none"> <li>▶ Fixați componenta împotriva căderii.</li> </ul>

### Cerință:

- ✓ Aparatul este deconectat de la sursa de energie electrică.

- ✓ Ușa piesei de mobilier este demontată. Consultați Instrucțiunile de montare.
- ✓ Ușa este deschisă.

### 4.2.1 Demontarea balamalei plate

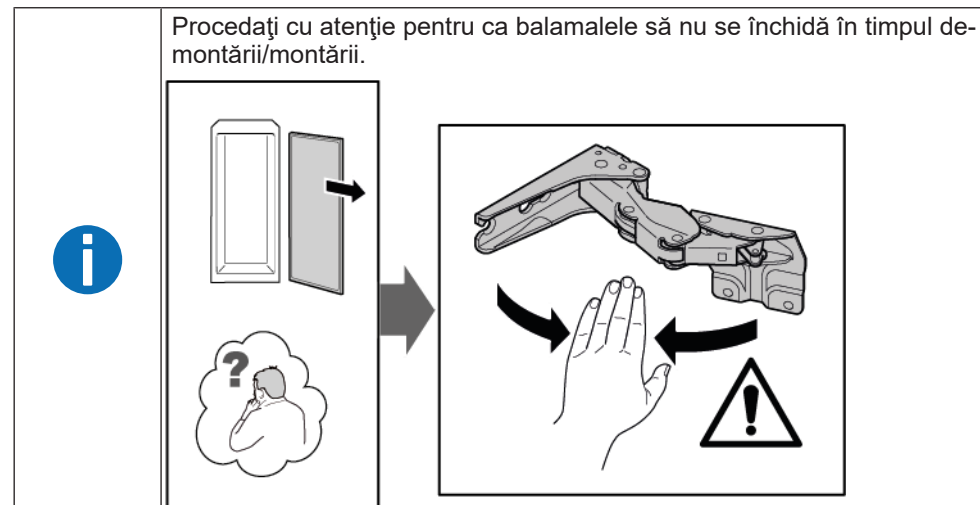

1. Demontați capacele a două balamale.

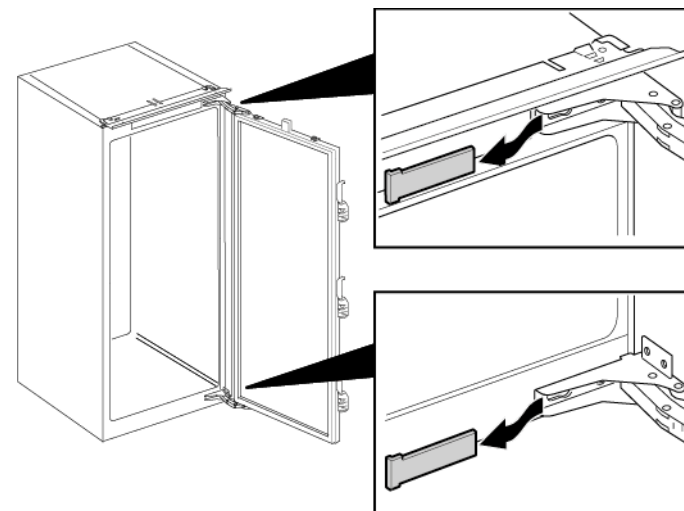

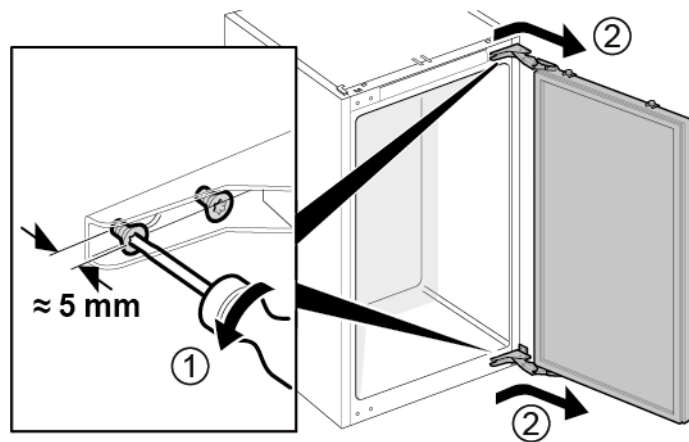

## Repararea

2. 1. Slăbiți patru șuruburi (1).
2. Glisați ușa în exterior și scoateți-o (2).

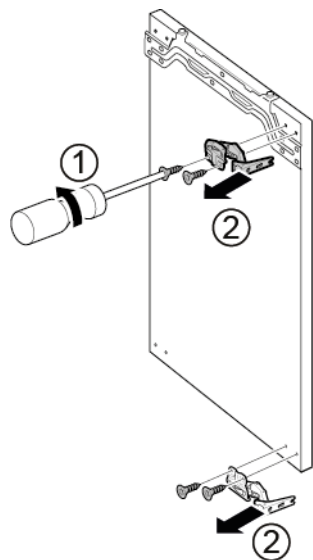

3. 1. Demontați patru șuruburi (1).
2. Demontați balamalele (2).



 Balamalele sunt demontate.

### 4.2.2 Montarea balamalei plate

- ▶ Montați urmând procedura de demontare în ordine inversă.

## 4.3 Înlocuirea balamalei glisante

### Scule speciale:

🔩 Cap torx TX20

6,3 mm (1/4")

[00340865]

	<b>⚠️ AVERTISMENT</b>
	<p><b>Aparate grele, masive!</b>                  Accidentarea spatelui și leziuni musculare</p> <ul style="list-style-type: none"> <li>▶ Operația de demontare a ușii aparatului trebuie efectuată numai de specialiști instruiți.</li> <li>▶ Pentru deplasarea aparatului sunt necesare două persoane.</li> <li>▶ Utilizați numai instrumente și echipamente adecvate.</li> </ul>

	<b>⚠️ ATENȚIONARE</b>
	<p><b>Marginea ascuțită!</b>                  Rănire prin tăiere</p> <ul style="list-style-type: none"> <li>▶ Purtați mănuși de protecție.</li> </ul>

	<b>⚠️ ATENȚIONARE</b>
	<p><b>Pericol din cauza pieselor care cad pentru că șuruburile sunt slăbite!</b>                  Accidente din cauza pieselor care cad.</p> <ul style="list-style-type: none"> <li>▶ Fixați componenta împotriva căderii.</li> </ul>

	<b>ATENȚIE!</b>
	<p><b>Pericol din cauza pieselor care cad pentru că șuruburile sunt slăbite!</b>                  Deteriorarea altor piese ale aparatului sau a casei clientului, de exemplu, partea de jos.</p> <ul style="list-style-type: none"> <li>▶ Fixați componenta împotriva căderii.</li> </ul>

### Cerință:

- ✔️ Aparatul este deconectat de la sursa de energie electrică.
- ✔️ Ușa piesei de mobilier și ușa aparatului sunt separate. Consultați Instrucțiunile de montare.

### 4.3.1 Demontarea balamalei glisante

- ▶ 1. Deșurubați două șuruburi (1).
- ▶ 2. Demontați balamaua de sus (2).
- ▶ 3. Demontați ușa (3).
- ▶ 4. Deșurubați două șuruburi (4).
- ▶ 5. Demontați balamaua de jos (5).

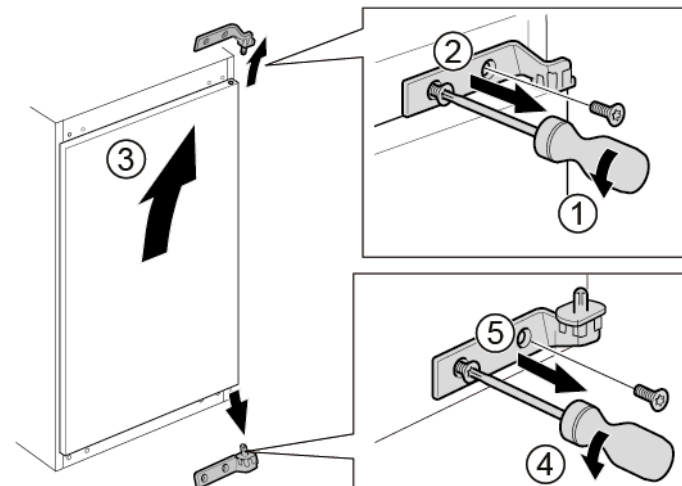

➡️ Balamalele sunt demontate.

### 4.3.2 Montarea balamalei glisante

- ▶ Montați urmând procedura de demontare în ordine inversă.



## 4.4 Repoziționarea raftului

### Cerință:

- ✔ Ușa este deschisă.

### 4.4.1 Demontarea raftului

- ▶ Scoateți raftul.

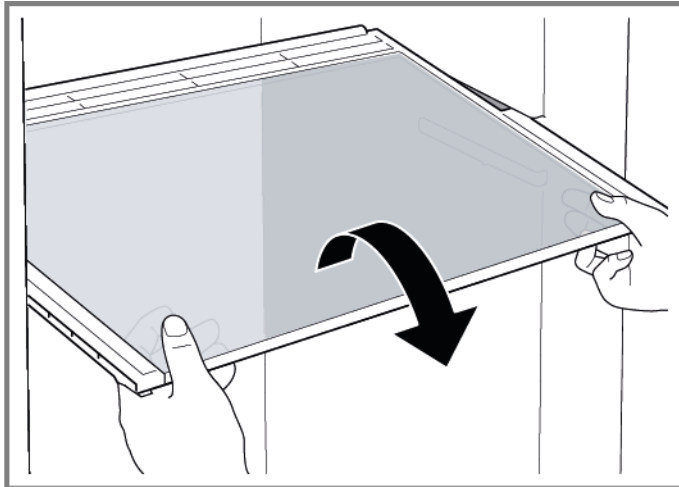

- ➡ Raftul este demontat.

### 4.4.2 Montarea raftului

- ▶ Montați urmând procedura de demontare în ordine inversă.

## 4.5 Repoziționarea raftului pentru ușă

### Cerință:

- ✔ Ușa este deschisă.

### 4.5.1 Demontarea raftului pentru ușă

- ▶ Ridicați raftul pentru ușă.

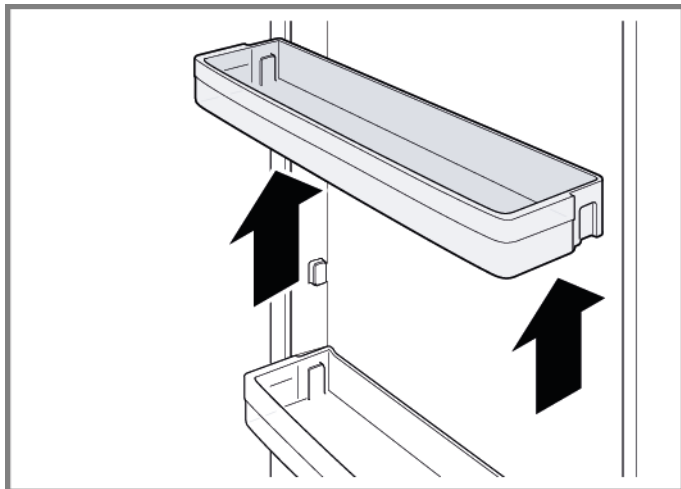

- ➡ Raftul pentru ușă este demontat.

### 4.5.2 Montarea raftului pentru ușă

- ▶ Montați urmând procedura de demontare în ordine inversă.

### 4.6 Repoziționarea containerului pentru fructe și legume

#### Cerință:

- ✔ Ușa este deschisă.

#### 4.6.1 Demontarea containerului pentru fructe și legume

1. Trageți în afară containerul pentru fructe și legume atât cât este posibil.
2. 1. Ridicați containerul pentru fructe și legume de partea din față (1).  
2. Scoateți containerul (2).

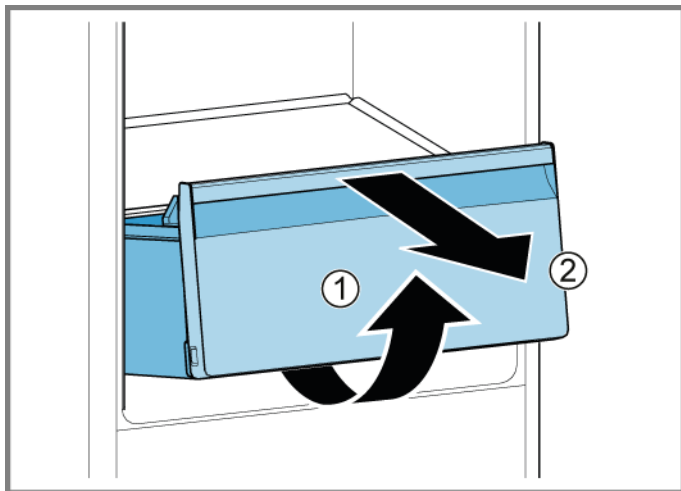

- ➔ Containerul pentru fructe și legume este demontat.

#### 4.6.2 Montarea containerului pentru fructe și legume

- ▶ Montați urmând procedura de demontare în ordine inversă.

## 4.7 Înlocuirea lămpii LED laterale

### Scule speciale:

🌀 Ventuză Ø50 mm [00342224]

	<p>Aparatul dumneavoastră este echipat cu o lampă LED care nu necesită întreținere.</p> <p>Aceste lămpi pot fi înlocuite numai de către departamentul de service pentru clienți sau de către tehnicieni autorizați!</p>
---	---

	<p style="text-align: center;"><b>⚠️ PERICOL</b></p> <p><b>Pericol de electrocutare din cauza pieselor sub tensiune!</b> Pericol de moarte prin electrocutare în cazul unei reparații necorespunzătoare</p> <ul style="list-style-type: none"><li>▶ Componentele electrice trebuie reparate de către electricieni calificați.</li><li>▶ După reparație, este obligatorie efectuarea unei verificări de siguranță conform cu VDE 0701 sau cu reglementările naționale respective.</li></ul>
--	--

	<p style="text-align: center;"><b>⚠️ PERICOL</b></p> <p><b>Pericol de electrocutare din cauza pieselor sub tensiune!</b> Deces prin electrocutare</p> <ul style="list-style-type: none"><li>▶ Deconectați aparatele de la sursa de alimentare cu tensiune cu cel puțin 60 de secunde înainte de a începe reparațiile.</li></ul>
--	---

	<p style="text-align: center;"><b>⚠️ ATENȚIONARE</b></p> <p><b>Marginea ascuțite!</b> Rănire prin tăiere</p> <ul style="list-style-type: none"><li>▶ Purtați mănuși de protecție.</li></ul>
--	---

### Cerință:

- ✔️ Aparatul este deconectat de la sursa de energie electrică.
- ✔️ Ușa este deschisă.
- ✔️ Rafturile sunt demontate.

### 4.7.1 Demontarea lămpii LED laterale

1. Aplicați două ventuze pe capacul lămpii LED laterale.

2. Trageți ventuzele în față, cu o mișcare de rotație.

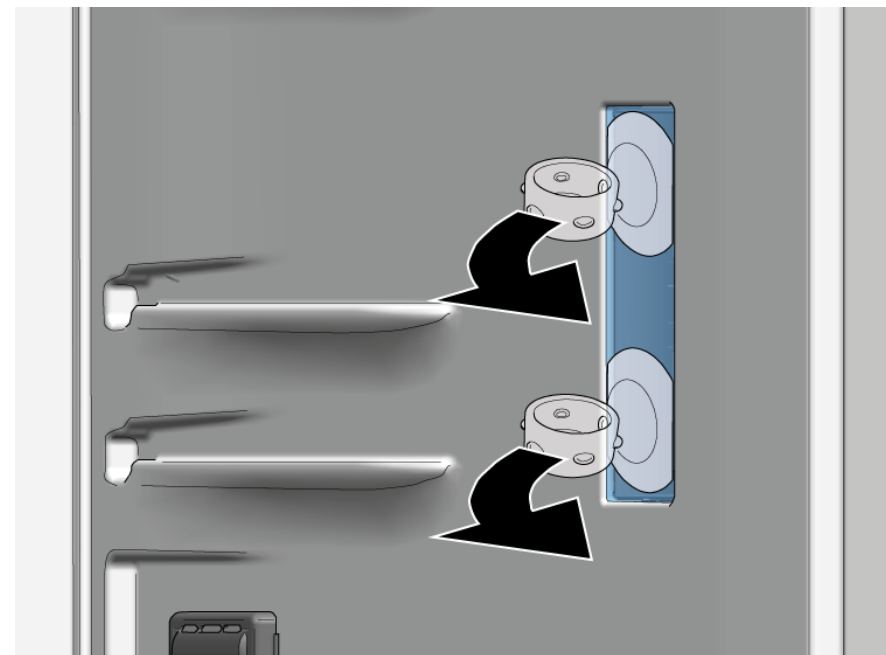

- ➡️ Capacul lămpii LED este demontat.

### 3. Demontarea modului LED.



 Lampa laterală LED este demontată.

#### 4.7.2 Montarea lămpii LED laterale



Deoarece cârligele capacului lămpii se pot sparge ușor în timpul procesului de demontare, lampa LED laterală piese de rezervă este un set care include modulul LED și capacul de lampă.

- ▶ Montați urmând procedura de demontare în ordine inversă.

# Poznámky k opravám - Chladnička

 <b>O tomto dokumente</b> .....	<b>307</b>
1.1 Dôležité informácie .....	307
1.1.1 Účel .....	307
1.2 Vysvetlenie symbolov .....	307
1.2.1 Úrovne nebezpečnosti .....	307
1.2.2 Symboly označujúce riziká.....	307
1.2.3 Štruktúra varovaní.....	308
1.2.4 Všeobecné symboly .....	308
 <b>Bezpečnosť</b> .....	<b>309</b>
2.1 Všeobecné bezpečnostné pokyny .....	309
2.1.1 Všetky domáce spotrebiče.....	309
 <b>Nástroje a pomôcky</b> .....	<b>310</b>
 <b>Oprava</b> .....	<b>311</b>
4.1 Výmena tesnenia dvierok .....	311
4.1.1 Odoberanie tesnenia dvierok .....	311
4.1.2 Montáž tesnenia dvierok.....	311
4.2 Výmena plochého závesu .....	314
4.2.1 Odobratie plochého závesu .....	314
4.2.2 Montáž plochého závesu .....	315
4.3 Výmena posuvného závesu .....	316
4.3.1 Odobratie posuvného závesu .....	316
4.3.2 Montáž posuvného závesu .....	316
4.4 Výmena odkladacej plochy .....	317
4.4.1 Odobratie odkladacej plochy.....	317
4.4.2 Montáž odkladacej plochy .....	317
4.5 Výmena poličky v dvierkach .....	318
4.5.1 Odobratie poličky v dvierkach .....	318
4.5.2 Montáž poličky do dvierok .....	318
4.6 Výmena nádoby na ovocie a zeleninu .....	319
4.6.1 Odobratie nádoby na ovocie a zeleninu .....	319
4.6.2 Montáž nádoby na ovocie a zeleninu.....	319
4.7 Výmena bočného LED svetla .....	320
4.7.1 Odobratie bočného LED svetla .....	320
4.7.2 Montáž bočného LED svetla .....	321

# **i** O tomto dokumente

## 1.1 Dôležité informácie

### 1.1.1 Účel

Tieto pokyny pre opravu pomáhajú spotrebiteľovi pri vlastnej oprave spotrebičov podľa nariadenia o ekodizajne (z marca 2021).

Obsahujú informácie o výmene určených náhradných dielov vrátane varovaní a rizík.

Ak máte otázky, kontaktujte náš zákaznícky servis. Za poškodenia ručíme len vtedy, ak pokyny boli dodržané správne.

## 1.2 Vysvetlenie symbolov

### 1.2.1 Úrovne nebezpečenstva

Úroveň varovania obsahuje symbol a signalizačné slovo. Signalizačné slovo naznačuje mieru nebezpečenstva.





Úroveň varovania	Význam
 <b>NEBEZPEČENSTVO</b>	Následkom nerešpektovania varovného hlásenia je úmrtie alebo vážne zranenia.
 <b>VAROVANIE</b>	Možným následkom nerešpektovania varovného hlásenia je úmrtie alebo vážne zranenia.
 <b>UPOZORNENIE</b>	Možným následkom nerešpektovania varovného hlásenia sú mierne zranenia.
 <b>POZOR!</b>	Možným následkom nerešpektovania varovného hlásenia je poškodenie majetku.

Tabuľka 1: Úrovne nebezpečenstva



### 1.2.2 Symboly označujúce riziká

Symboly označujúce riziká sú symbolické znázornenia, ktoré naznačujú druh nebezpečenstva.

V tomto dokumente sa používajú nasledujúce symboly označujúce riziká:

Symbol označujúci riziko	Význam
	Všeobecné varovné hlásenie
	Nebezpečenstvo v súvislosti s elektrickým napätím
	Nebezpečenstvo výbuchu
	Nebezpečenstvo porezania
	Nebezpečenstvo pomliaždenia

## **i** O tomto dokumente

Symbol označujúci riziko	Význam
	Nebezpečenstvo v súvislosti s horúcimi povrchmi
	Nebezpečenstvo v súvislosti s magnetickým poľom
	Nebezpečenstvo v súvislosti s neionizujúcou radiáciou

Tabuľka 2: Symboly označujúce riziká

### 1.2.3 Štruktúra varovaní

Varovania v tomto dokumente majú štandardný vzhľad a štandardnú štruktúru.



	<p><b>⚠ NEBEZPEČENSTVO</b></p> <p><b>Druh a zdroj nebezpečenstva!</b> Možné následky pri ignorovaní nebezpečenstva/varovania.</p> <ul style="list-style-type: none"> <li>▶ Opatrenia a zákazy na zabránenie nebezpečenstvu.</li> </ul>
--	--





Nasledujúci príklad znázorňuje varovanie pred zásahom elektrickým prúdom pri dotyku s časťami pod napätím. Je uvedené opatrenie na predídenie nebezpečenstvu.

	<p><b>⚠ NEBEZPEČENSTVO</b></p> <p><b>Nebezpečenstvo úrazu elektrickým prúdom pri dotyku s časťami pod napätím!</b> Úmrtie v dôsledku zásahu elektrickým prúdom</p> <ul style="list-style-type: none"> <li>▶ Odpojte spotrebiče od elektrického zdroja aspoň 60 sekúnd pred začiatkom opráv.</li> </ul>
---	--

### 1.2.4 Všeobecné symboly

V tomto dokumente sa používajú nasledujúce všeobecné symboly:

Všeob. symbol	Význam
	Označenie špeciálneho pokynu (textové a/alebo grafické)
	Označenie jednoduchého pokynu (len textové)

Všeob. symbol	Význam
	Označenie prepojenia na videonávod
	Označenie požadovaných nástrojov
	Označenie požadovaných podmienok
	Označenie podmienky (ak ..., potom ...)
	Označenie výsledku
[Spustenie]	Označenie klávesu alebo tlačidla
[00123456]	Označenie čísla materiálu
Stav	Označenie zobrazeného textu/okna (na displeji spotrebiča)

Tabuľka 3: Všeobecné symboly



## **2.1 Všeobecné bezpečnostné pokyny**

### **2.1.1 Všetky domáce spotrebiče**

#### **Nebezpečenstvo úrazu elektrickým prúdom pri dotyku s časťami pod napätím!**

- Chyby pri opravách na elektrických komponentoch môžu spôsobiť zásah elektrickým prúdom!
- Odpojte spotrebič od elektrickej siete aspoň 60 sekúnd pred začiatkom práce.
- Po oprave zariadenia vykonajte bezpečnostný test v súlade s nariadením VDE 0701 alebo s miestnymi nariadeniami.

#### **Riziko poranenia na ostrých hranách!**

- Noste ochranné rukavice.

#### **Riziko pomliaždenia počas opravy, údržby, riešenia problémov a servisu na ťažkých a pohybujúcich sa komponentoch**

- Noste ochrannú obuv.
- Zaisťte ťažké komponenty proti pádu.
- Nesiahajte končatinami do pohybujúcich sa komponentov.



#### **Riziko ohrozenia bezpečnosti/funkčnosti spotrebiča!**

- Používajte len originálne náhradné diely.

#### **Riziko poškodenia elektrostaticky citlivých komponentov (ESD)!**

- Nedotýkajte sa modulov vrátane prípojok a vedení vodičov.

## Nástroje a pomôcky

Označenie	Detaily	Snímky
Ochranná látka [00342013]	60 cm x 50 cm	
Prísavný držiak [00342224]	Ø50 mm	
Bit Torx TX20 [00340865]	6,3 mm (1/4")	

## 4.1 Výmena tesnenia dvierok

### Požiadavka:

- ✔ Dvierka sú otvorené.

### 4.1.1 Odoberanie tesnenia dvierok

1. Uvoľnite tesnenie dvierok z drážky na pravom a ľavom rohu.

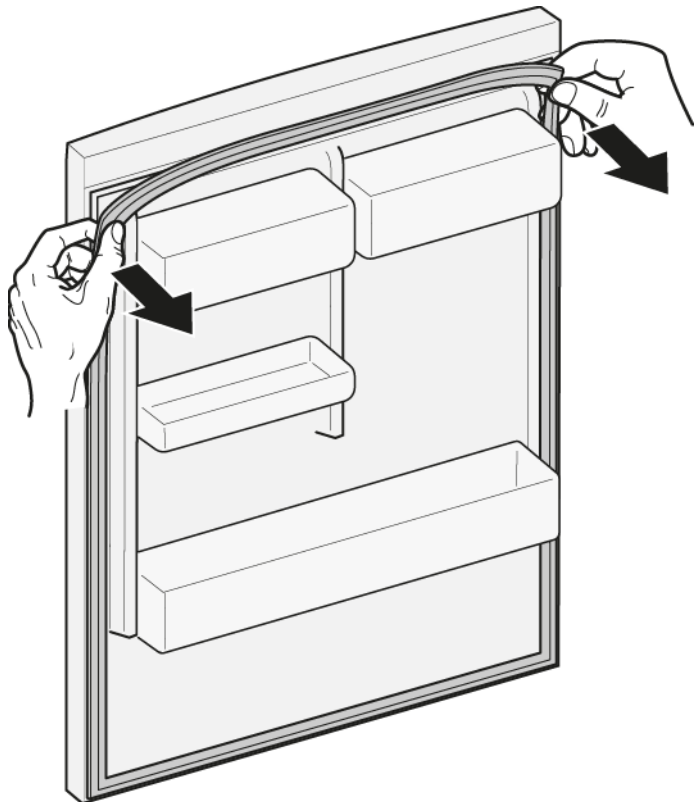

2. Vytiahnite tesnenie z drážky.



- ➡ Tesnenie dvierok je odobraté.

### 4.1.2 Montáž tesnenia dvierok



Hrúbka nového tesnenia dvierok sa môže mierne odlišovať od hrúbky starého tesnenia dvierok. Neovplyvní to zatváranie ani funkčnosť z dlhodobého hľadiska.

Ak má váš spotrebič nastaviteľné závesy alebo závesové úchytky, postupne môžete optimalizovať spôsob zatvárania.

Malé bočné dierky v tesnení dvierok majú svoju funkciu (sú potrebné na vetranie). Nie sú výrobnu chybou.

1. Skontrolujte poškodenie drážky na tesnenie.



4. Hore a dole vtláčte rohy tesnenia do drážky.

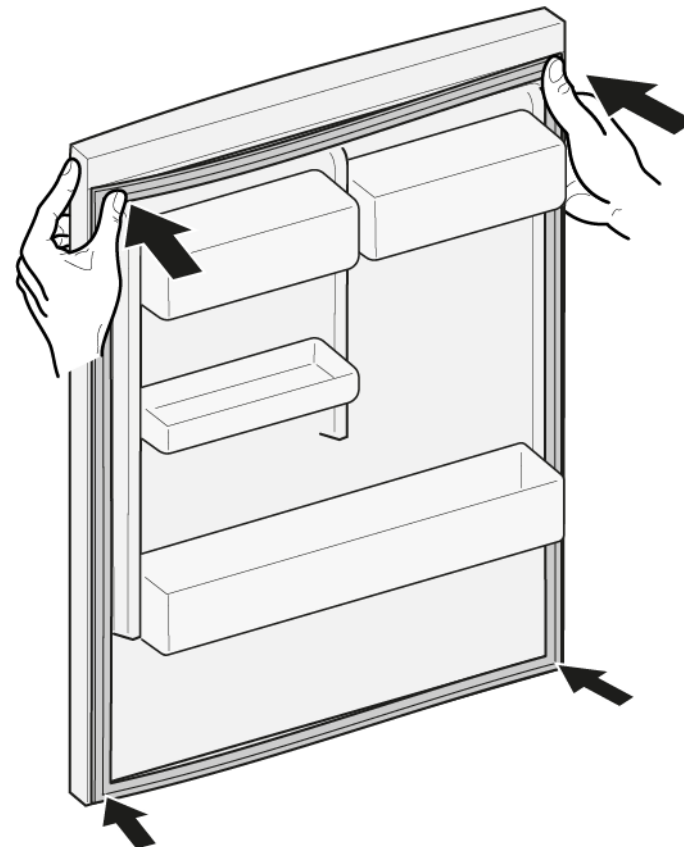

2.  Ak je drážka tesnenia je poškodená.  
- Kontaktujte zákaznícky servis.

3.  Mierna deformácia tesnenia dvierok je normálna a neovplyvňuje jeho funkciu. Odporúča sa vyrovnať tesnenie pred jeho vloženíom do spotrebiča.

Nahrejte tesnenie dvierok použitím fénu alebo horúcej vody a manuálne ho vytvarujte.

5. Jedno miesto po druhom vtlačte celé tesnenie do drážky.

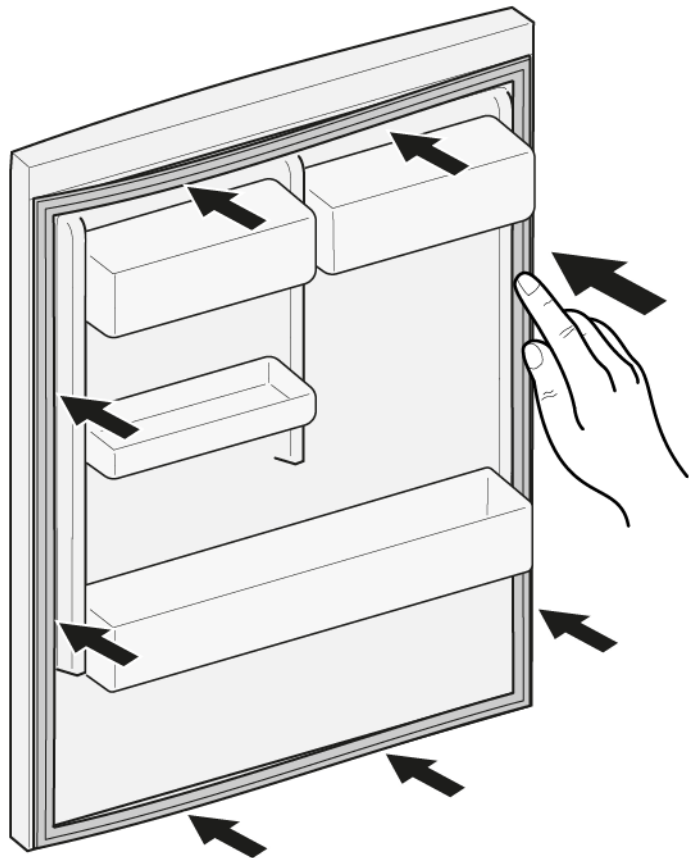



-  Tesnenie dvierok je namontované.

## 4.2 Výmena plochého závesu

### Špeciálne nástroje:

 Bit Torx TX20      6,3 mm (1/4")      [00340865]

	<b>VAROVANIE</b>
	<p><b>Ťažké, objemné spotrebiče!</b> Poranenie chrbta a svalov</p> <ul style="list-style-type: none"> <li>▶ Proces odobrania dverok spotrebiča by mal vykonávať školený odborník.</li> <li>▶ Na presunutie spotrebiča sa vyžadujú dve osoby.</li> <li>▶ Použite vhodné nástroje a vybavenie.</li> </ul>



	<b>UPOZORNENIE</b>
	<p><b>Ostré hrany!</b> Rezné poranenia</p> <ul style="list-style-type: none"> <li>▶ Noste ochranné rukavice.</li> </ul>

	<b>UPOZORNENIE</b>
	<p><b>Otvorte oblasť závesov!</b> Pomliaždenie/zachytenie prstov</p> <ul style="list-style-type: none"> <li>▶ Nesiahajte do priestoru závesov.</li> <li>▶ Noste ochranné rukavice.</li> </ul>

	<b>UPOZORNENIE</b>
	<p><b>Riziko pádu dielov po uvoľnení skrutiek!</b> Zranenie padajúcimi dielmi.</p> <ul style="list-style-type: none"> <li>▶ Zaistite komponent proti pádu.</li> </ul>

	<b>POZOR!</b>
	<p><b>Riziko pádu dielov po uvoľnení skrutiek!</b> Poškodenie iných častí spotrebiča alebo domácnosti zákazníka, napr. podlahy.</p> <ul style="list-style-type: none"> <li>▶ Zaistite komponent proti pádu.</li> </ul>

### Požiadavka:

-  Spotrebič je odpojený od elektrického napájania.
-  Dvierka nábytku sú odobraté. Prečítajte si návod na montáž.
-  Dvierka sú otvorené.

### 4.2.1 Odobratie plochého závesu



1. Odoberte dva kryty závesu.

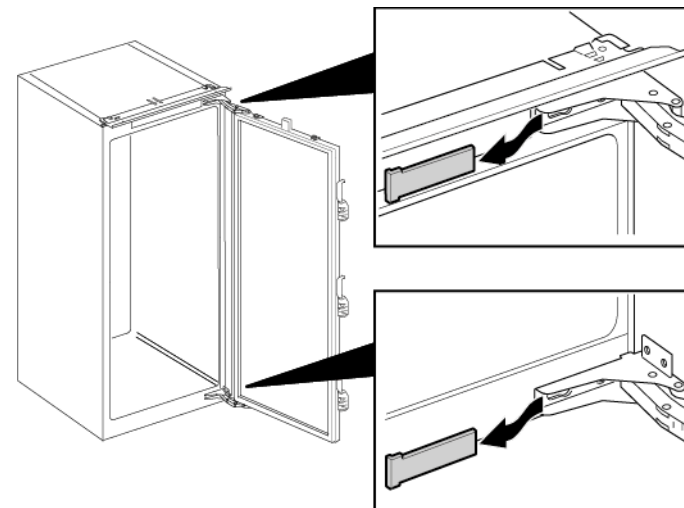

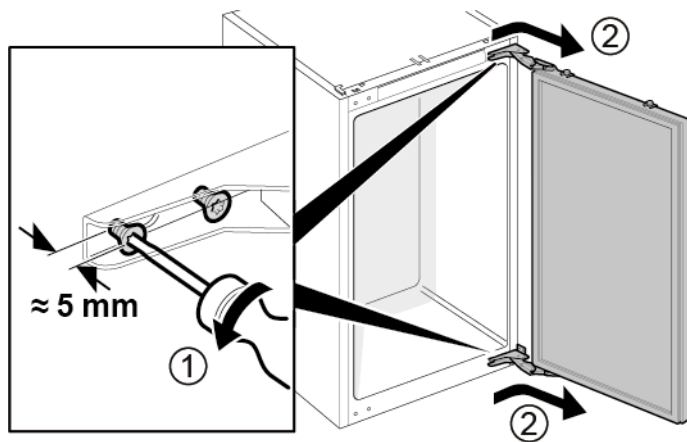

## Oprava

2. 1. Uvoľnite štyri skrutky (1).
2. Vysuňte a odoberte dverka (2).

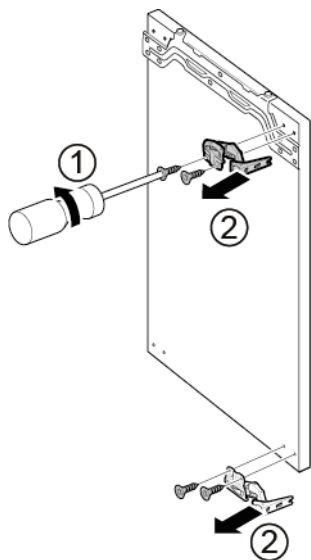

3. 1. Odoberte štyri skrutky (1).
2. Odoberte závesy (2).



 Závesy sú odobraté.

### 4.2.2 Montáž plochého závesu

- Pri montáži postupujte v opačnom poradí krokov demontáže.

## 4.3 Výmena posuvného závesu

### Špeciálne nástroje:

Bit Torx TX20 6,3 mm (1/4") [00340865]

	<b>VAROVANIE</b>
	<p><b>Ťažké, objemné spotrebiče!</b> Poranenie chrbta a svalov</p> <ul style="list-style-type: none"> <li>▶ Proces odoberania dvierok spotrebiča by mal vykonávať školený odborník.</li> <li>▶ Na presunutie spotrebiča sa vyžadujú dve osoby.</li> <li>▶ Použite vhodné nástroje a vybavenie.</li> </ul>

	<b>UPOZORNENIE</b>
	<p><b>Ostré hrany!</b> Rezné poranenia</p> <ul style="list-style-type: none"> <li>▶ Noste ochranné rukavice.</li> </ul>

	<b>UPOZORNENIE</b>
	<p><b>Riziko pádu dielov po uvoľnení skrutiek!</b> Zranenie padajúcimi dielmi.</p> <ul style="list-style-type: none"> <li>▶ Zaistite komponent proti pádu.</li> </ul>

	<b>POZOR!</b>
	<p><b>Riziko pádu dielov po uvoľnení skrutiek!</b> Poškodenie iných častí spotrebiča alebo domácnosti zákazníka, napr. podlahy.</p> <ul style="list-style-type: none"> <li>▶ Zaistite komponent proti pádu.</li> </ul>

### Požiadavka:

- ✔ Spotrebič je odpojený od elektrického napájania.
- ✔ Dvierka nábytku a dvierka spotrebiča sú oddelené. Prečítajte si návod na montáž.

### 4.3.1 Odobratie posuvného závesu

- ▶ 1. Odskrutkujte dve skrutky (1).
- ▶ 2. Odoberte horný záves (2).
- ▶ 3. Odoberte dvierka (3).
- ▶ 4. Odskrutkujte dve skrutky (4).
- ▶ 5. Odoberte spodný záves (5).

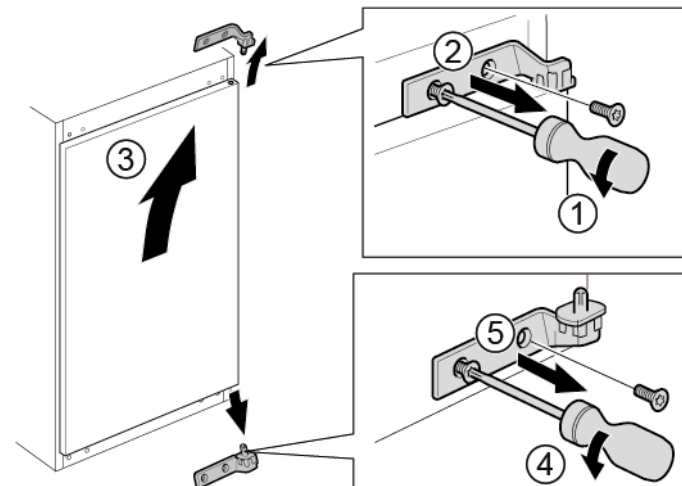

➡ Závesy sú odobraté.

### 4.3.2 Montáž posuvného závesu

- ▶ Pri montáži postupujte v opačnom poradí krokov demontáže.



## 4.4 Výmena odkladacej plochy

### Požiadavka:

- ✔ Dvierka sú otvorené.

### 4.4.1 Odobratie odkladacej plochy

- ▶ Vytiahnite odkladaciu plochu.

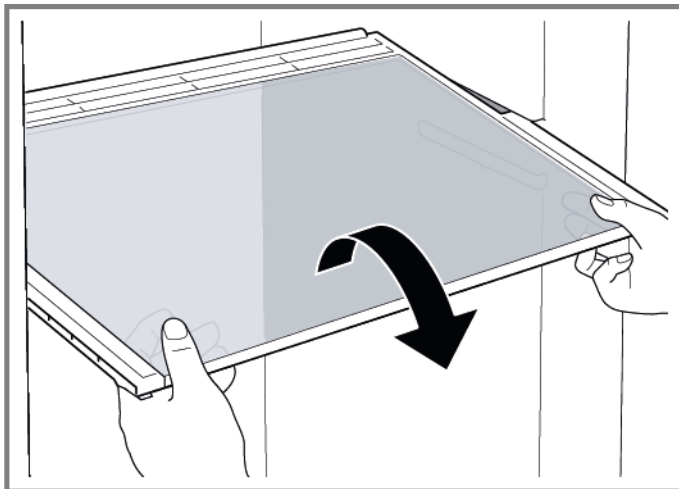

- ➡ Odkladacia plocha je odobratá.

### 4.4.2 Montáž odkladacej plochy

- ▶ Pri montáži postupujte v opačnom poradí krokov demontáže.

## 4.5 Výmena poličky v dvierkach

### Požiadavka:

- ✔ Dvierka sú otvorené.

### 4.5.1 Odobratie poličky v dvierkach

- ▶ Poličku v dvierkach zodvihnite smerom nahor.

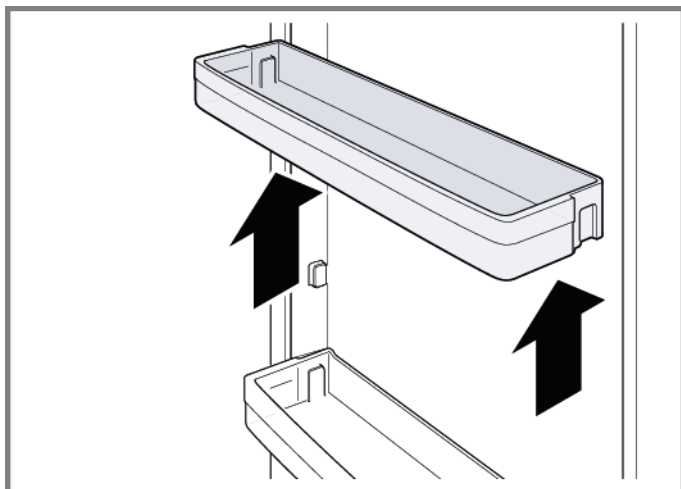

- ➡ Polička v dvierkach je odobratá.

### 4.5.2 Montáž poličky do dvierok

- ▶ Pri montáži postupujte v opačnom poradí krokov demontáže.

## 4.6 Výmena nádoby na ovocie a zeleninu

### Požiadavka:

- ✔ Dvierka sú otvorené.

### 4.6.1 Odobratie nádoby na ovocie a zeleninu

1. Čo najviac vyťahnite nádobu na ovocie a zeleninu.
2. 1. Nadvihnite nádobu na ovocie a zeleninu za prednú časť (1).  
2. Odoberte nádobu (2).

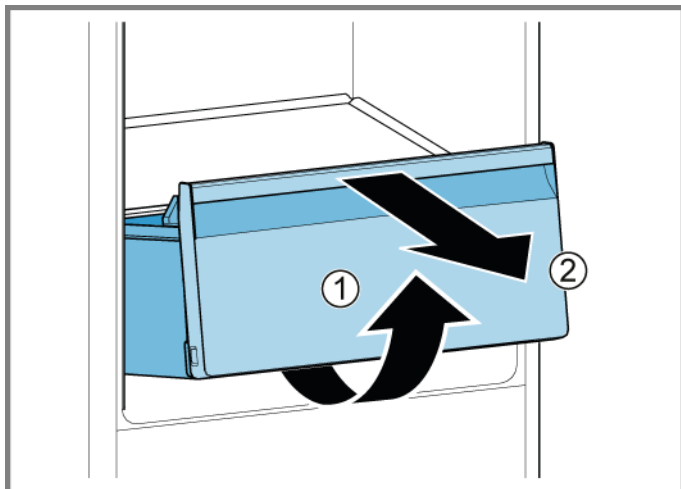

- ➔ Nádobu na ovocie a zeleninu je odobratá.

### 4.6.2 Montáž nádoby na ovocie a zeleninu

- ▶ Pri montáži postupujte v opačnom poradí krokov demontáže.

## 4.7 Výmena bočného LED svetla

### Špeciálne nástroje:

 Prísavný držiak Ø50 mm [00342224]

 Vo výbave vášho spotrebiča je bezúdržbové LED svetlo. Tieto svetlá môže opravovať len zákaznícky servis alebo oprávnený technik!

 **NEBEZPEČENSTVO**  
**Nebezpečenstvo úrazu elektrickým prúdom pri dotyku s časťami pod napätím!**  
 Ohrozenie života spôsobené elektrickým zásahom v prípade nesprávnej opravy

- ▶ Elektrické diely má opravovať kvalifikovaný elektrikár.
- ▶ Po oprave zariadenie vykonať bezpečnostný test v súlade s nariadením VDE 0701 alebo s miestnymi nariadeniami.



 **NEBEZPEČENSTVO**  
**Nebezpečenstvo úrazu elektrickým prúdom pri dotyku s časťami pod napätím!**  
 Úmrtie v dôsledku zásahu elektrickým prúdom

- ▶ Odpojte spotrebiče od elektrického zdroja aspoň 60 sekúnd pred začiatkom opráv.

 **UPOZORNENIE**  
**Ostré hrany!**  
 Rezné poranenia

- ▶ Noste ochranné rukavice.

### Požiadavka:

-  Spotrebič je odpojený od elektrického napájania.
-  Dvierka sú otvorené.
-  Poličky sú odobraté.

### 4.7.1 Odobratie bočného LED svetla

1. Nalepte dva prísavné držiaky na hornú tretinu krytu bočného LED svetla.

2. Potiahnite prísavky dopredu jedným otočným pohybom.

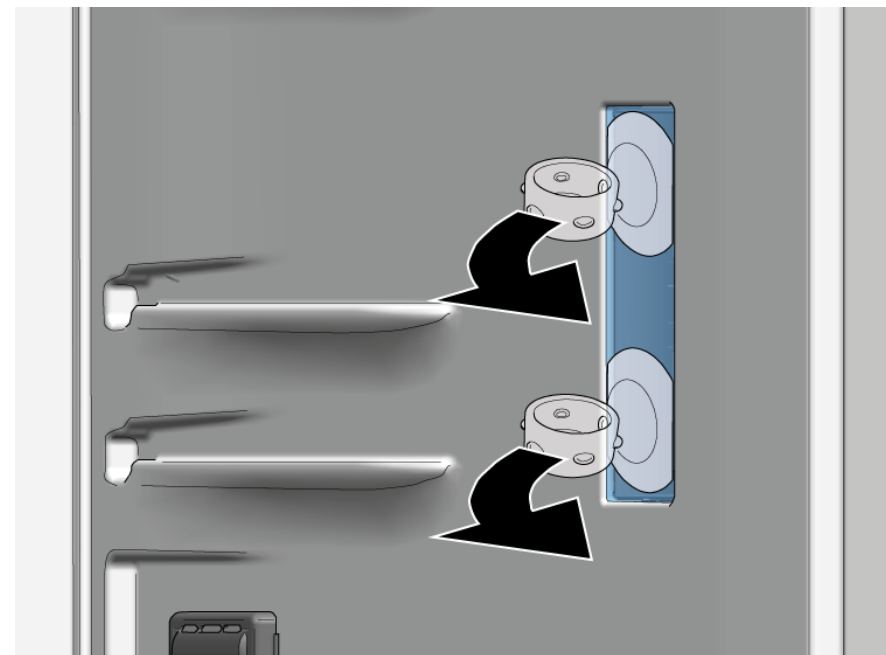

 Kryt LED svetla je odobratý.

3. Odoberte LED modul.

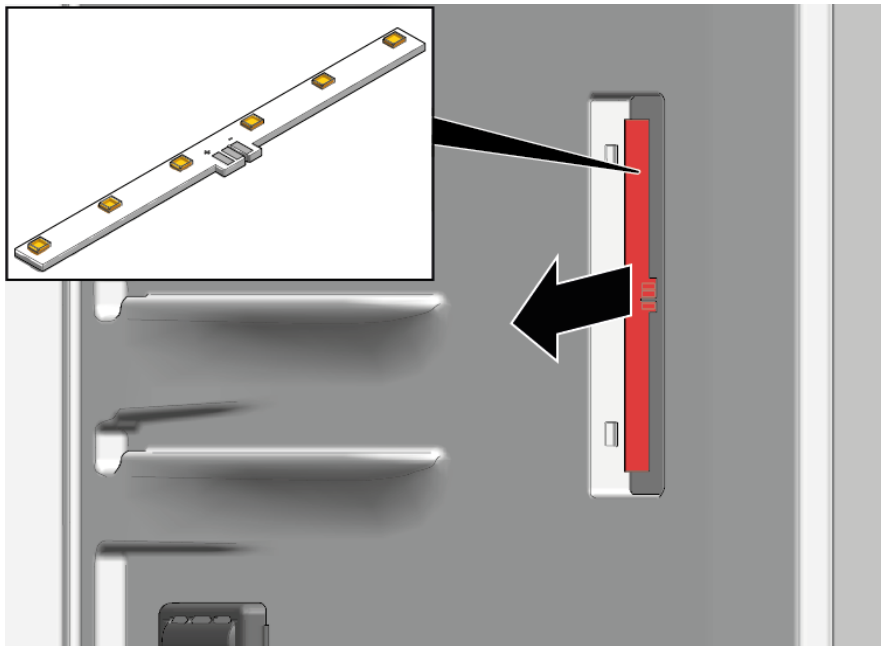

 Bočné LED svetlo je odobraté.

### 4.7.2 Montáž bočného LED svetla



Keďže háčiky krytu žiarovky sú náchylné na zlomenie počas procesu odoberania, náhradný diel - bočné LED svetlo - je sada, ktorá obsahuje LED modul a kryt svetla.

- ▶ Pri montáži postupujte v opačnom poradí krokov demontáže.

# Nasveti za popravilo - Hladilnik

 <b>V zvezi s tem dokumentom .....</b>	<b>323</b>
1.1 Pomembne informacije .....	323
1.1.1 Namen .....	323
1.2 Razlaga simbolov .....	323
1.2.1 Stopnje nevarnosti .....	323
1.2.2 Simboli za nevarnost .....	323
1.2.3 Struktura opozoril .....	324
1.2.4 Splošni simboli .....	324
 <b>Varnost.....</b>	<b>325</b>
2.1 Splošna varnostna navodila .....	325
2.1.1 Vsi gospodinjski aparati .....	325
 <b>Orodja in pripomočki.....</b>	<b>326</b>
 <b>Popravilo .....</b>	<b>327</b>
4.1 Zamenjava tesnila vrat .....	327
4.1.1 Odstranjevanje tesnila vrat .....	327
4.1.2 Namestitev tesnila vrat .....	327
4.2 Zamenjava ploščatega tečaja .....	330
4.2.1 Odstranjevanje ploščatega tečaja .....	330
4.2.2 Namestitev ploščatega tečaja .....	331
4.3 Zamenjava drsnega tečaja .....	332
4.3.1 Odstranjevanje drsnega tečaja .....	332
4.3.2 Namestitev drsnega tečaja .....	332
4.4 Zamenjava police .....	333
4.4.1 Odstranjevanje police .....	333
4.4.2 Namestitev police .....	333
4.5 Zamenjava vratnega predala .....	334
4.5.1 Odstranjevanje vratnega predala .....	334
4.5.2 Namestitev vratnega predala .....	334
4.6 Zamenjava predala za sadje in zelenjavo .....	335
4.6.1 Odstranjevanje predala za sadje in zelenjavo .....	335
4.6.2 Namestitev predala za sadje in zelenjavo .....	335
4.7 Zamenjava stranske luči LED .....	336
4.7.1 Odstranjevanje stranske luči LED .....	336
4.7.2 Namestitev stranske luči LED .....	337

# **i** V zvezi s tem dokumentom

## 1.1 Pomembne informacije

### 1.1.1 Namen

Ti namigi za popravila uporabnika podpirajo pri lastnoročnem popravilu aparatov skladno z veljavno direktivo glede okoljsko primerne zasnove (od marca 2021).

Vsebujejo informacije o tem, kako zamenjati določene rezervne dele, vključno z opozorili in tveganji.

Če imate kakšna vprašanja, se obrnite na našo servisno službo. Za škodo bomo odgovorni le, če ste namige za popravila upoštevali pravilno.

## 1.2 Razlaga simbolov

### 1.2.1 Stopnje nevarnosti

Stopnje opozoril so sestavljene iz simbola in signalne besede. Signalna beseda označuje stopnjo nevarnosti.





Stopnja opozorila	Pomen
 <b>NEVARNOST</b>	Neupoštevanje opozorilnega sporočila bo povzročilo smrt ali hude poškodbe.
 <b>OPOZORILO</b>	Neupoštevanje opozorilnega sporočila lahko povzroči smrt ali hude poškodbe.
 <b>PREVIDNO</b>	Neupoštevanje opozorilnega sporočila lahko povzroči manjše poškodbe.
<b>POZOR!</b>	Neupoštevanje opozorilnega sporočila lahko povzroči škodo na lastnini.

*Preglednica 1: Stopnje nevarnosti*



### 1.2.2 Simboli za nevarnost

Simboli za nevarnost so simbolni prikazi, ki podajajo informacije o vrsti nevarnosti.

V tem dokumentu so uporabljeni naslednji simboli za nevarnost:

Simbol za nevarnost	Pomen
	Splošno opozorilno sporočilo
	Nevarnost zaradi električne napetosti
	Nevarnost eksplozije
	Nevarnost ureznin
	Nevarnost zmečkanin

## **i** V zvezi s tem dokumentom

Simbol za nevarnost	Pomen
	Nevarnost zaradi vročih površin
	Nevarnost zaradi močnega magnetnega polja
	Nevarnost zaradi neionizirajočega sevanja

Preglednica 2: Simboli za nevarnost

### 1.2.3 Struktura opozoril

Opozorila v tem dokumentu imajo standardiziran videz in standardizirano strukturo.



	<div style="background-color: red; color: white; padding: 2px; display: inline-block;"><b>NEVARNOST</b></div> <p><b>Vrsta in vir nevarnosti!</b> Morebitne posledice ob neupoštevanju nevarnosti/opozorila.</p> <ul style="list-style-type: none"> <li>▶ Ukrepi in prepovedi za preprečevanje nevarnosti.</li> </ul>
--	--





V naslednjem primeru je prikazano opozorilo, ki opozarja pred električnim udarom zaradi delov pod napetostjo. Naveden je ukrep za preprečevanje nevarnosti.

	<div style="background-color: red; color: white; padding: 2px; display: inline-block;"><b>NEVARNOST</b></div> <p><b>Nevarnost električnega udara zaradi delov pod napetostjo!</b> Smrt zaradi električnega udara</p> <ul style="list-style-type: none"> <li>▶ Izključite aparate iz električnega omrežja vsaj 60 sekund pred začetkom popravil.</li> </ul>
---	--

### 1.2.4 Splošni simboli

V tem dokumentu so uporabljeni naslednji splošni simboli:

Splošni simbol	Pomen
	Identifikacija posebnega nasveta (besedilo in/ali slika)
	Identifikacija preprostega nasveta (samo besedilo)
	Identifikacija povezave na video vadnico

Splošni simbol	Pomen
	Identifikacija potrebnih orodij
	Identifikacija potrebnih predpogojev
	Identifikacija pogoja (če ..., potem ...)
	Identifikacija rezultata
Začetek	Identifikacija tipke ali gumba
[00123456]	Identifikacija številke dela
Stanje	Identifikacija prikazanega besedila/okna (na zaslonu aparata)

Preglednica 3: Splošni simboli



## 2.1 Splošna varnostna navodila

### 2.1.1 Vsi gospodinjski aparati

#### **Nevarnost električnega udara zaradi delov pod napetostjo!**

- Napake zaradi popravil električnih komponent lahko povzročijo električni udar!
- Aparat izključite iz električnega omrežja vsaj 60 sekund pred začetkom del.
- Po popravilu je treba izvesti preizkus varnosti v skladu z VDE 0701 ali predpisi, ki veljajo za posamezno državo.

#### **Nevarnost poškodb zaradi ostrih robov!**

- Uporabljajte zaščitne rokavice.

#### **Nevarnost zmečkanin med popravili, vzdrževanjem, odpravljanjem težav ali servisom zaradi težkih in premikajočih se komponent**

- Uporabljajte zaščitne čevlje.
- Težke komponente zavarujte pred padanjem.
- Delov telesa ne vstavljajte v premikajoče se komponente.



#### **Tveganje za varnost/delovanje aparata!**

- Uporabljajte le originalne nadomestne dele.

#### **Tveganje poškodb elektrostatično občutljivih komponent (ESD)!**

- Ne dotikajte se modulov, vključno s povezavami in potmi vodnika.

## Orodja in pripomočki

Oznaka	Podrobnosti	Slike
Zaščitna krpa [00342013]	60 cm x 50 cm	
Vakuumski prisesek [00342224]	Ø50 mm	
Nastavek Torx TX20 [00340865]	6,3 mm (1/4")	

## 4.1 Zamenjava tesnila vrat

### Zahteva:

- ✔ Vrata so odprta.

### 4.1.1 Odstranjanje tesnila vrat

1. V levem in desnem kotu sprostite tesnilo vrat iz utora.



2. Tesnilo vrat izvlecite iz utora.



- ➡ Tesnilo vrat je odstranjeno.

### 4.1.2 Namestitvev tesnila vrat



Debelina novega tesnila vrat se lahko nekoliko razlikuje od starega tesnila vrat. To ne vpliva na zapiranje in dolgoročno delovanje aparata.

Če ima aparat nastavljive tečaje ali priključke tečajev, lahko zapiranje naknadno tudi prilagodite.

Majhne stranske luknje v tesnilu vrat imajo svoj namen (potrebne so za prezračevanje). Ne gre za proizvodne napake.

## Popravilo

1. Preverite, ali je utor za tesnilo poškodovan.

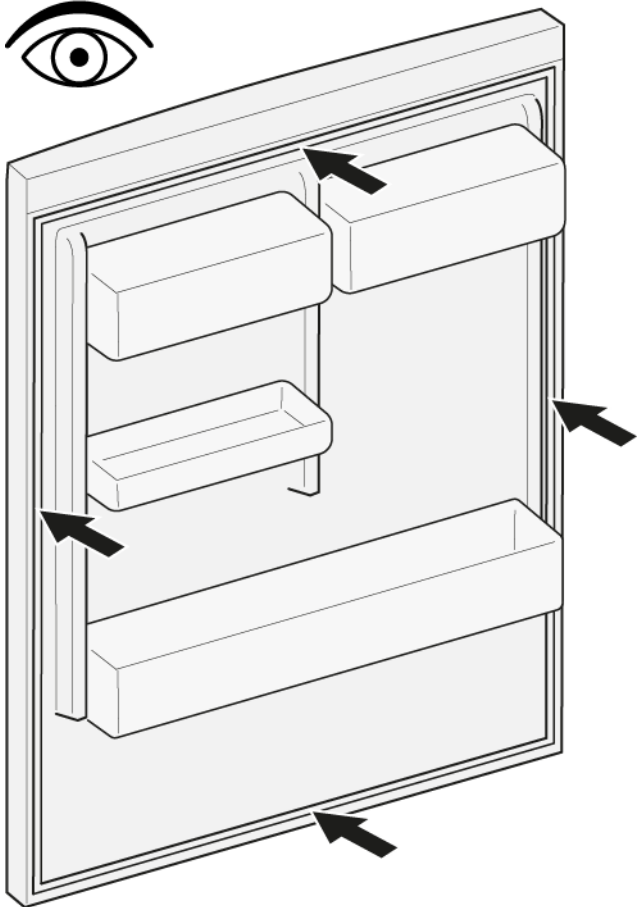

4. Vogale tesnila zgoraj in spodaj potisnite v utor.

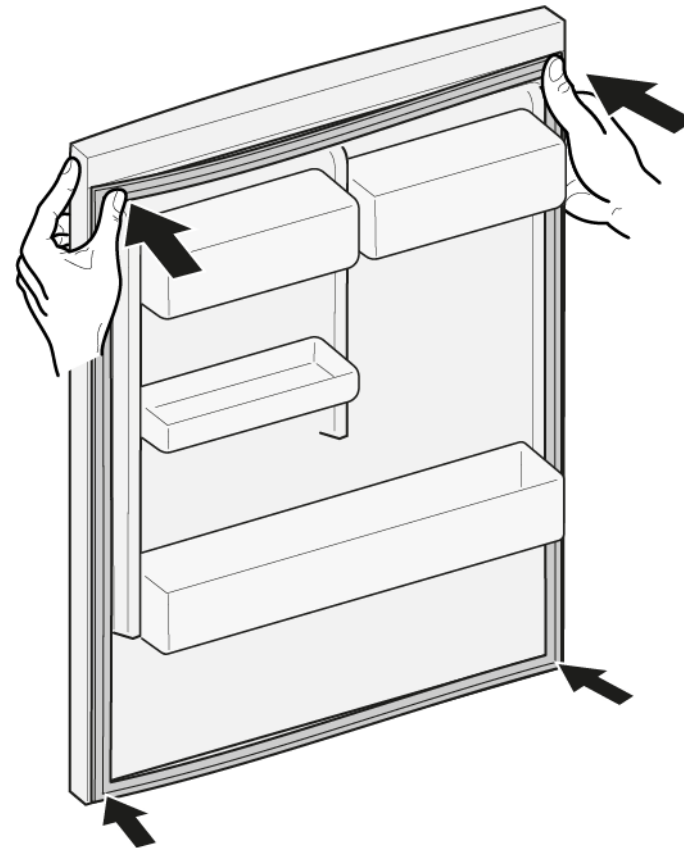

2.  Če je utor za tesnilo poškodovan:
  - se obrnite na našo servisno službo.

3.  Majhna deformacija tesnila vrat je običajna in ne vpliva na njegovo delovanje. Priporočljivo je, da tesnilo vrat pred namestitvijo v aparat poravnate.

Tesnilo vrat lahko segrejete s sušilnikom za lase ali toplo vodo, da ga ročno preoblikujete.

## Popravilo

5. Celotno tesnilo korak po koraku potisnite v utor.





 Tesnilo vrat je nameščeno.

## 4.2 Zamenjava ploščatega tečaja

Posebna orodja:

🌀 Nastavek Torx TX20      6,3 mm (1/4")      [00340865]

	<b>⚠️ OPOZORILO</b>
	<p><b>Težki, veliki aparati!</b> Poškodbe hrbta in mišic</p> <ul style="list-style-type: none"> <li>▶ Postopek odstranjevanja vrat aparata naj izvaja samo pooblašče-no strokovno osebje.</li> <li>▶ Za premikanje aparata sta potrebni dve osebi.</li> <li>▶ Uporabite samo ustrezno orodje in opremo.</li> </ul>

	<b>⚠️ PREVIDNO</b>
	<p><b>Ostri robovi!</b> Ureznine</p> <ul style="list-style-type: none"> <li>▶ Uporabljajte zaščitne rokavice.</li> </ul>

	<b>⚠️ PREVIDNO</b>
	<p><b>Odprite območje tečaja!</b> Zmečkanine/zagozditev prstov</p> <ul style="list-style-type: none"> <li>▶ Ne segajte v območje tečajev.</li> <li>▶ Uporabljajte zaščitne rokavice.</li> </ul>

	<b>⚠️ PREVIDNO</b>
	<p><b>Nevarnost padajočih delov zaradi zrahljanih vijakov!</b> Poškodbe zaradi padajočih delov.</p> <ul style="list-style-type: none"> <li>▶ Komponento zaščitite pred padcem.</li> </ul>

	<b>POZOR!</b>
	<p><b>Nevarnost padajočih delov zaradi zrahljanih vijakov!</b> Škoda na drugih delih aparata ali pri uporabniku doma, npr. na tleh.</p> <ul style="list-style-type: none"> <li>▶ Komponento zaščitite pred padcem.</li> </ul>

Zahteva:

- ✅ Aparat je odklopljen iz omrežne napetosti.
- ✅ Pohištvna vrata so odstranjena. Glejte navodila za namestittev.
- ✅ Vrata so odprta.

### 4.2.1 Odstranjevanje ploščatega tečaja

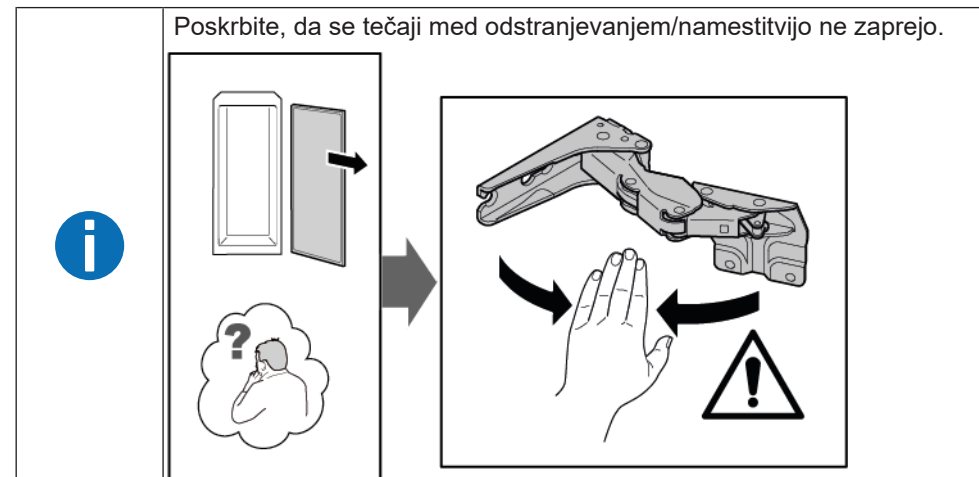

1. Odstranite pokrovčka tečaja.

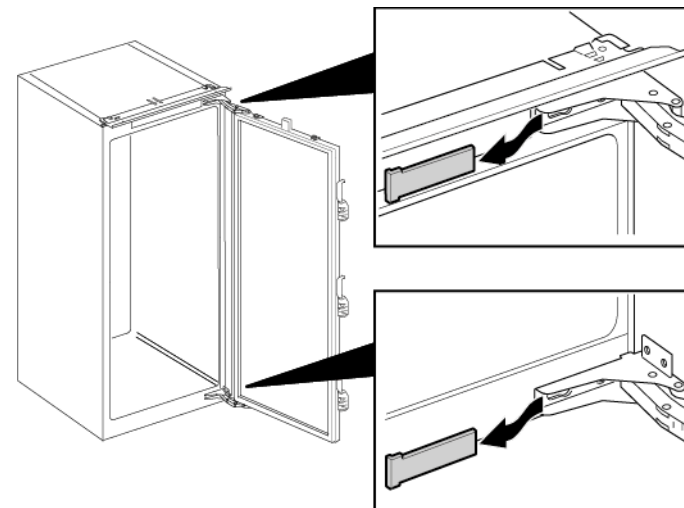

## Popravilo

2. 1. Odvijte štiri vijake (1).
2. Vrata izvlecite in jih odstranite (2).

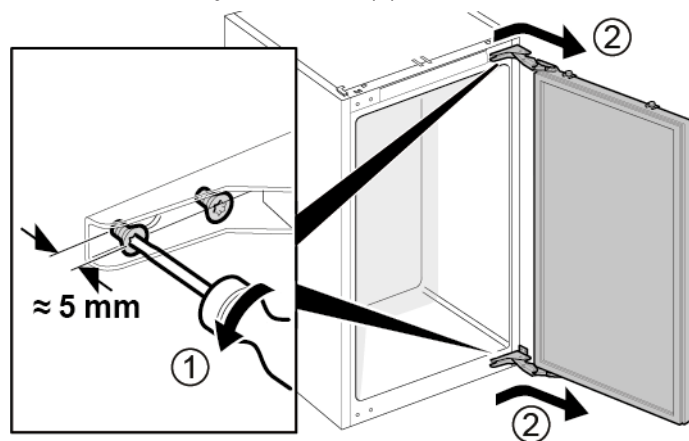

3. 1. Odstranite štiri vijake (1).
2. Odstranite tečaja (2).

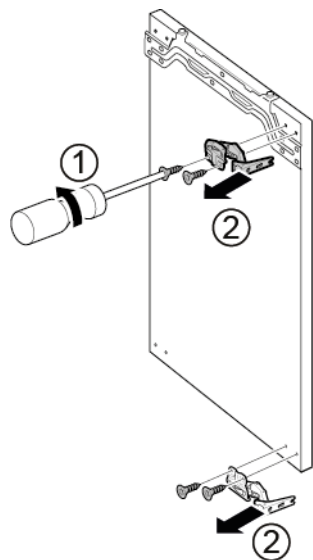

 Tečaja sta odstranjena.

### 4.2.2 Namestitev ploščatega tečaja

- ▶ Namestite v obratnem vrstnem redu.

## 4.3 Zamenjava drsnega tečaja

### Posebna orodja:

🌀 Nastavek Torx TX20      6,3 mm (1/4")      [00340865]

	<b>⚠️ OPOZORILO</b>
<b>Težki, veliki aparati!</b>	
Poškodbe hrbta in mišic	
<ul style="list-style-type: none"> <li>▶ Postopek odstranjevanja vrat aparata naj izvaja samo pooblašče-no strokovno osebje.</li> <li>▶ Za premikanje aparata sta potrebni dve osebi.</li> <li>▶ Uporabite samo ustrezno orodje in opremo.</li> </ul>	

	<b>⚠️ PREVIDNO</b>
<b>Ostri robovi!</b>	
Ureznine	
<ul style="list-style-type: none"> <li>▶ Uporabljajte zaščitne rokavice.</li> </ul>	

	<b>⚠️ PREVIDNO</b>
<b>Nevarnost padajočih delov zaradi zrahljanih vijakov!</b>	
Poškodbe zaradi padajočih delov.	
<ul style="list-style-type: none"> <li>▶ Komponento zaščitite pred padcem.</li> </ul>	

	<b>POZOR!</b>
<b>Nevarnost padajočih delov zaradi zrahljanih vijakov!</b>	
Škoda na drugih delih aparata ali pri uporabi doma, npr. na tleh.	
<ul style="list-style-type: none"> <li>▶ Komponento zaščitite pred padcem.</li> </ul>	

### Zahteva:

- ✔️ Aparat je odklopljen iz omrežne napetosti.
- ✔️ Pohištvena vrata so ločena od vrat aparata. Glejte navodila za namestitev.

## 4.3.1 Odstranjevanje drsnega tečaja

- ▶ 1. Odvijte vijaka (1).
- ▶ 2. Odstranite zgornji tečaj (2).
- ▶ 3. Odstranite vrata (3).
- ▶ 4. Odvijte vijaka (4).
- ▶ 5. Odstranite spodnji tečaj (5).

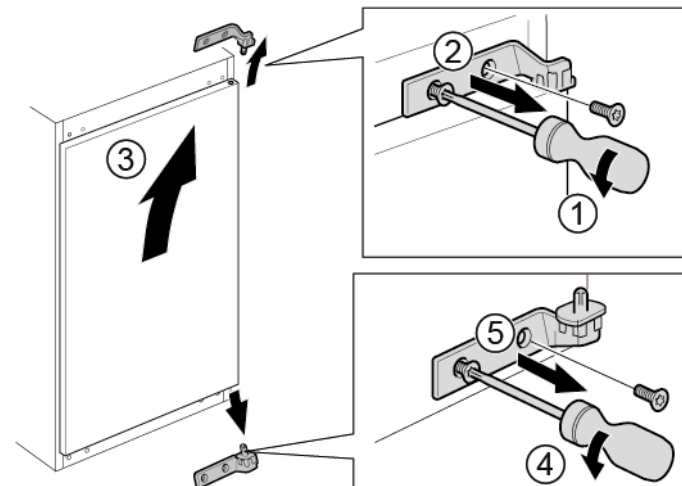

➡ Tečaja sta odstranjena.

## 4.3.2 Namestitev drsnega tečaja

- ▶ Namestite v obratnem vrstnem redu.



## 4.4 Zamenjava police

### Zahteva:

- ✔ Vrata so odprta.

### 4.4.1 Odstranjevanje police

- ▶ Izvlecite polico.

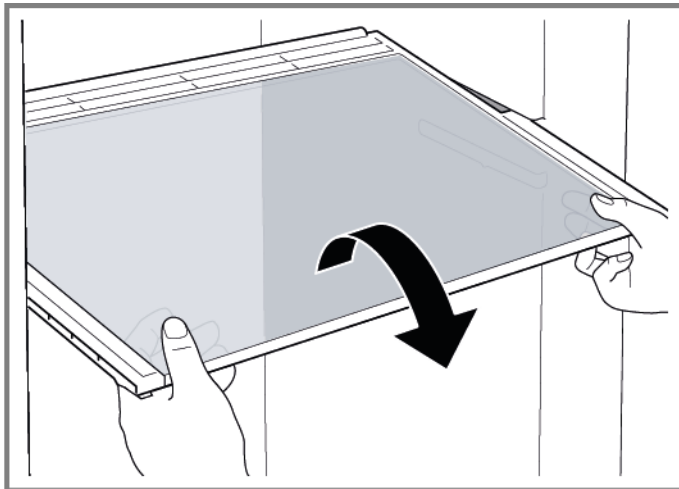

- ➡ Polica je odstranjena.

### 4.4.2 Namestitev police

- ▶ Namestite v obratnem vrstnem redu.

## 4.5 Zamenjava vratnega predala

### Zahteva:

- ✔ Vrata so odprta.

### 4.5.1 Odstranjevanje vratnega predala

- ▶ Dvignite vrtni predal navzgor.



- ➡ Vratni predal je odstranjen.

### 4.5.2 Namestitev vratnega predala

- ▶ Namestite v obratnem vrstnem redu.

## 4.6 Zamenjava predala za sadje in zelenjavo

### Zahteva:

- ✔ Vrata so odprta.

### 4.6.1 Odstranjevanje predala za sadje in zelenjavo

1. Predal za sadje in zelenjavo izvlecite, kolikor je mogoče.
2. 1. Dvignite predal za sadje in zelenjavo spredaj (1).  
2. Predal odstranite (2).



- ➔ Predal za sadje in zelenjavo je odstranjen.

### 4.6.2 Namestitev predala za sadje in zelenjavo

- ▶ Namestite v obratnem vrstnem redu.

## 4.7 Zamenjava stranske luči LED

### Posebna orodja:

🔧 Vakuumski prisesek Ø50 mm [00342224]



Vaš aparat je opremljen z osvetlitvijo LED, ki ne potrebuje vzdrževanja. To vrsto osvetlitve lahko popravi samo servisna služba ali pooblaščen strokovno osebje!



### ⚠️ NEVARNOST

**Nevarnost električnega udara zaradi delov pod napetostjo!**  
Življenjska nevarnost zaradi električnega udara v primeru nepravilnega popravila

- ▶ Električne dele mora popraviti kvalificiran električar.
- ▶ Po popravilu je treba izvesti preizkus varnosti v skladu z VDE 0701 ali predpisi, ki veljajo za posamezno državo.



### ⚠️ NEVARNOST

**Nevarnost električnega udara zaradi delov pod napetostjo!**  
Smrt zaradi električnega udara

- ▶ Izključite aparate iz električnega omrežja vsaj 60 sekund pred začetkom popravil.



### ⚠️ PREVIDNO

**Ostri robovi!**  
Ureznine

- ▶ Uporabljajte zaščitne rokavice.

### Zahteva:

- ✓ Aparat je odklopljen iz omrežne napetosti.
- ✓ Vrata so odprta.
- ✓ Police so odstranjene.

### 4.7.1 Odstranjevanje stranske luči LED

1. Dva priseska namestite na pokrov stranske luči LED.

2. S krožnim gibom povlecite priseska k sebi.

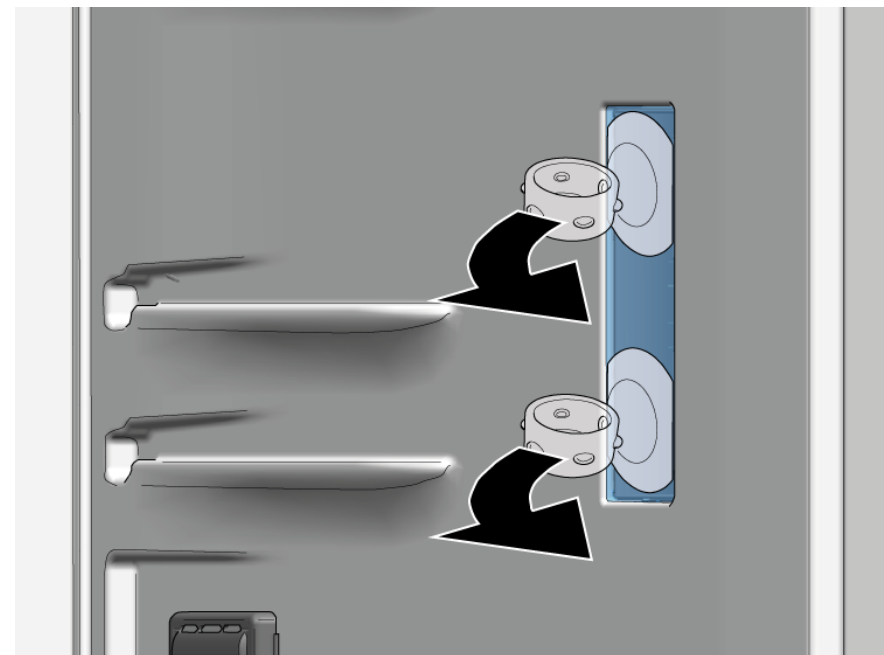

- ➡ Pokrov stranske luči LED je odstranjen.

3. Odstranite LED-modul.



 Stranska luč LED je odstranjena.





### 4.7.2 Namestitev stranske luči LED



Ker se zatiči pokrovčka med postopkom odstranjevanja zlahka zlomijo, vključuje komplet nadomestnega dela stranske luči LED LED-modul in pokrov luči.

- ▶ Namestite v obratnem vrstnem redu.

# Consejos de reparación - Frigorífico

 <b>En relación con este documento</b> .....	<b>339</b>
1.1 Información importante .....	339
1.1.1 Finalidad .....	339
1.2 Explicación de símbolos generales .....	339
1.2.1 Niveles de peligrosidad .....	339
1.2.2 Símbolos de peligro .....	339
1.2.3 Estructura de las advertencias .....	340
1.2.4 Símbolos generales .....	340
 <b>Seguridad</b> .....	<b>341</b>
2.1 Instrucciones generales de seguridad .....	341
2.1.1 Todos los aparatos electrodomésticos.....	341
 <b>Herramientas y auxiliares</b> .....	<b>342</b>
 <b>Reparación</b> .....	<b>343</b>
4.1 Sustituir la junta de la puerta .....	343
4.1.1 Retirar la junta de la puerta.....	343
4.1.2 Montar la junta de la puerta .....	343
4.2 Sustituir la bisagra plana .....	346
4.2.1 Desmontar la bisagra plana .....	346
4.2.2 Montar la bisagra plana .....	347
4.3 Sustituir la bisagra deslizante .....	348
4.3.1 Desmontar la bisagra deslizante .....	348
4.3.2 Montar la bisagra deslizante .....	348
4.4 Sustituir el estante .....	349
4.4.1 Extraer el estante .....	349
4.4.2 Montar el estante .....	349
4.5 Sustituir el estante de la puerta .....	350
4.5.1 Extraer el estante de la puerta .....	350
4.5.2 Montar el estante de la puerta.....	350
4.6 Sustituir el cajón para fruta y verdura .....	351
4.6.1 Extraer el cajón para fruta y verdura.....	351
4.6.2 Montar el cajón para fruta y verdura .....	351
4.7 Sustituir la iluminación LED lateral.....	352
4.7.1 Retirar la iluminación LED lateral .....	352
4.7.2 Montar la iluminación LED lateral.....	353

# **i** En relación con este documento

## 1.1 Información importante

### 1.1.1 Finalidad

Estas indicaciones de reparación sirven como ayuda al consumidor para reparar aparatos por su cuenta conforme al reglamento aplicable sobre diseño ecológico (a partir de 03/2021).

Contienen información sobre cómo sustituir repuestos determinados e incluye las advertencias y los riesgos.

En caso de dudas, póngase en contacto con nuestro departamento de atención al cliente. Solo asumiremos la responsabilidad por daños si las indicaciones de reparación se han seguido correctamente.

## 1.2 Explicación de símbolos generales

### 1.2.1 Niveles de peligrosidad

Los niveles de peligro consisten en un símbolo y una palabra de advertencia. La palabra de advertencia identifica la gravedad del peligro.





Nivel de peligro	Significado
 <b>PELIGRO</b>	Si no se tiene en cuenta la advertencia, ocasionará la muerte o lesiones graves.
 <b>ADVERTENCIA</b>	Si no se tiene en cuenta la advertencia, puede ocasionar la muerte o lesiones graves.
 <b>PRECAUCIÓN</b>	Si no se tiene en cuenta la advertencia, puede ocasionar lesiones de carácter leve.
<b>ATENCIÓN</b>	Si no se tiene en cuenta la advertencia, puede ocasionar daños materiales.

Tabla 1: Niveles de peligrosidad

### 1.2.2 Símbolos de peligro

Los símbolos de peligro son una representación simbólica que indica el tipo de peligrosidad.

En este documento se utilizan los siguientes símbolos de peligro:

Símbolo de peligro	Significado
	Advertencia general
	Peligro de lesiones por corriente eléctrica
	Riesgo de explosión
	Peligro de lesiones a causa de cortes

## **i** En relación con este documento





Símbolo de peligro	Significado
	Peligro de lesiones por aplastamiento
	Peligro de lesiones por superficies calientes
	Peligro a causa de campos magnéticos de gran potencia
	Peligro derivado de radiación no ionizante

Tabla 2: Símbolos de peligro

### 1.2.3 Estructura de las advertencias

Las advertencias de este documento tienen una apariencia y una estructura uniformes.

	<p><b>⚠ PELIGRO</b></p> <p><b>¡Tipo y fuente del peligro!</b> Posibles consecuencias de ignorar el peligro / la advertencia.</p> <ul style="list-style-type: none"> <li>▶ Medidas y prohibiciones para prevenir el peligro.</li> </ul>
--	--

El ejemplo siguiente muestra una advertencia de descarga eléctrica a causa de piezas o partes cargadas con tensión. Se menciona la medida para evitar el peligro.

	<p><b>⚠ PELIGRO</b></p> <p><b>¡Riesgo de descarga eléctrica debido a partes con tensión!</b> Muerte por electrocución</p> <ul style="list-style-type: none"> <li>▶ Desconectar el aparato de la red al menos 60 segundos antes de comenzar con la reparación.</li> </ul>
--	--

### 1.2.4 Símbolos generales

En este documento se utilizan los siguientes símbolos generales:

Símbolo general	Significado
	Identificación de una indicación especial (texto y/o gráfico)







Símbolo general	Significado
	Identificación de un consejo simple (solo texto)
	Identificación de un enlace a un video tutorial
	Identificación de una herramienta requerida
	Identificación de una condición previa (prerrequisito)
	Identificación de una condición (si ..., entonces ...)
	Identificación de un resultado
Iniciar	Identificación de una tecla o botón
[00123456]	Identificación de un número de material
Estado	Identificación del texto / ventana mostrada (en el display del aparato)

Tabla 3: Símbolos generales



## 2.1 Instrucciones generales de seguridad

### 2.1.1 Todos los aparatos electrodomésticos

#### ¡Riesgo de descarga eléctrica debido a piezas con tensión!

- ¡Los errores en las reparaciones que incluyan componentes eléctricos pueden provocar una descarga eléctrica!
- Desconectar el aparato de la red durante al menos 60 segundos antes de comenzar con el trabajo.
- Después de la reparación, encargar una prueba de seguridad conforme a VDE 0701 o los reglamentos específicos del país.

#### ¡Riesgo de lesiones debido a bordes afilados!

- Usar guantes de protección.

#### Riesgo de aplastamiento durante la reparación, mantenimiento, resolución de problemas y servicio debido a componentes pesados y móviles

- Usar calzado de seguridad.
- Asegure los componentes pesados para que no se caigan.
- No pegue partes del cuerpo en componentes móviles.



#### ¡Riesgo para la seguridad/el funcionamiento del aparato!

- Utilizar únicamente los repuestos originales.

#### ¡Riesgo de daños de los componentes sensibles a cargas electrostáticas (ESD)!

- No tocar los módulos, incluidas las conexiones y las pistas conductoras.

## Herramientas y auxiliares

Designacion	Detalles	Imágenes
Paño de protección [00342013]	60 cm x 50 cm	
Ventosa [00342224]	Ø50 mm	
Punta Torx TX20 [00340865]	6,3 mm (1/4")	

## 4.1 Sustituir la junta de la puerta

### Requisito:

- ✔ La puerta está abierta.

### 4.1.1 Retirar la junta de la puerta

1. Soltar la junta de la puerta de la ranura por las esquinas izquierda y derecha.

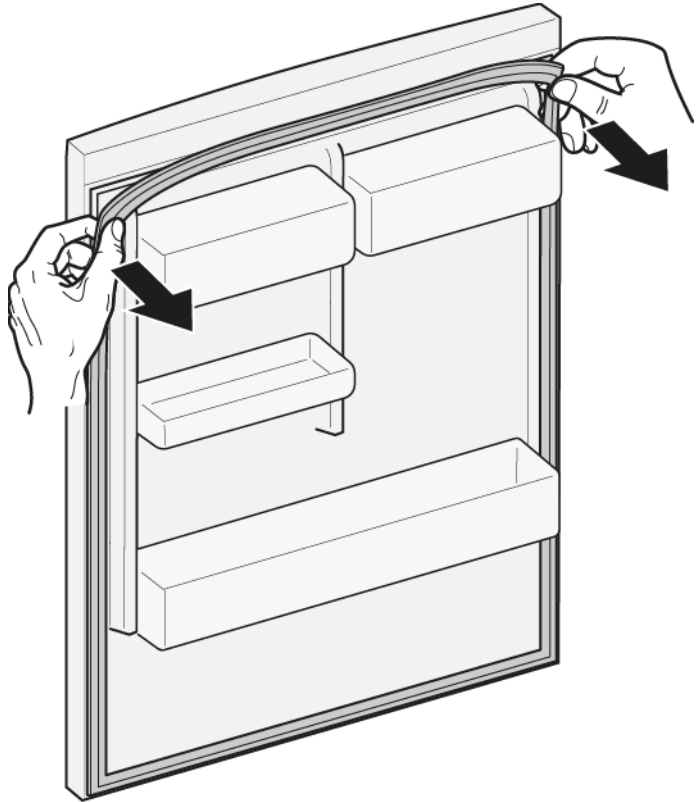

2. Sacar la junta de la puerta de la ranura.

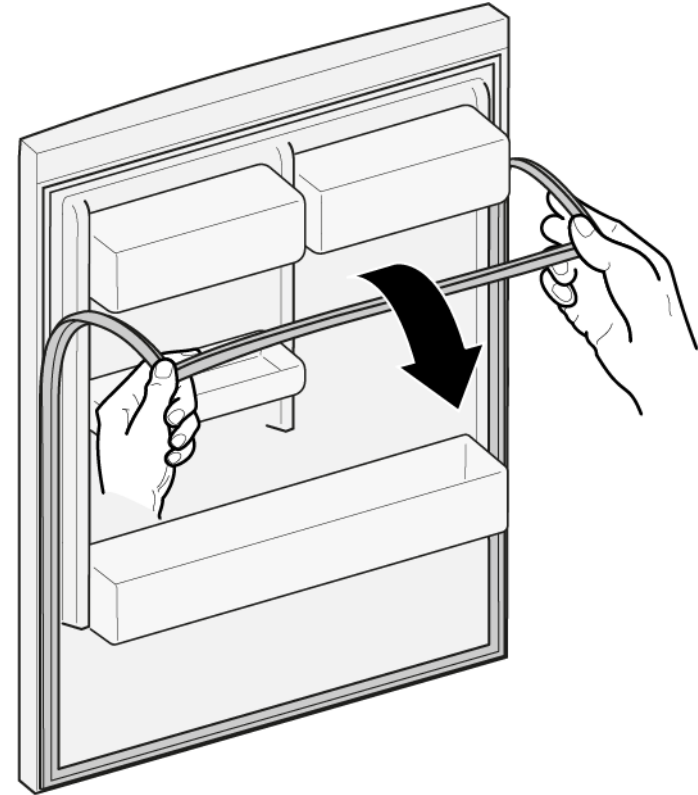

- ➡ Se ha retirado la junta de la puerta.

### 4.1.2 Montar la junta de la puerta



El grosor de la nueva junta de la puerta puede diferir ligeramente del grosor de la junta usada. Esto no afectará al comportamiento de cierre ni al funcionamiento a largo plazo.

Si su aparato tienen bisagras ajustables o accesorios de bisagra, puede optimizar el comportamiento de cierre.

Los pequeños agujeros laterales de la junta de la puerta son funcionales (necesarios para la ventilación). No se trata de un fallo de producción.

## Reparación

1. Comprobar si la ranura de la junta presenta daños.



4. Presionar las esquinas de la junta en la parte superior y la inferior de la ranura.

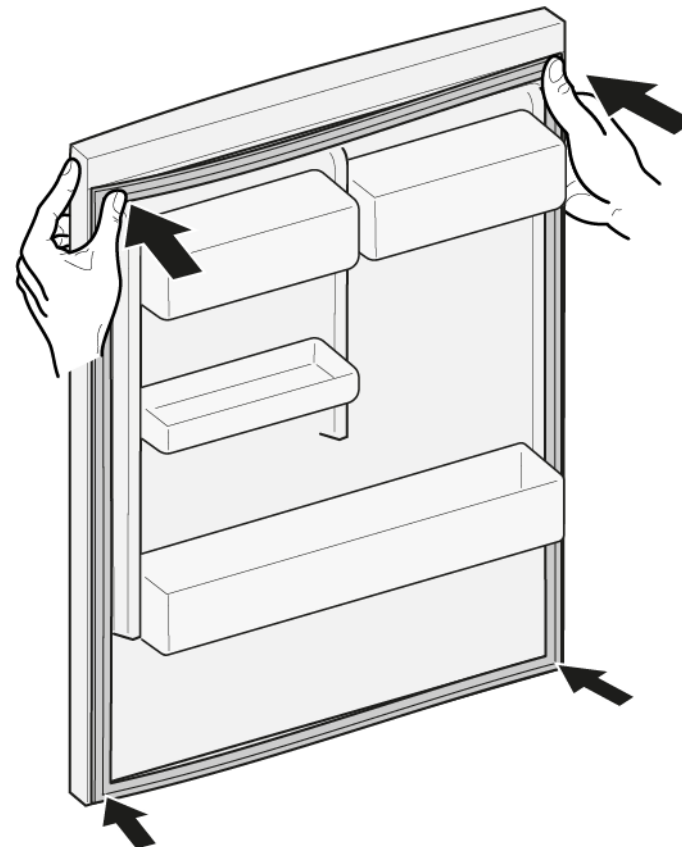

2.  Si la ranura de la junta está dañada.  
- Contactar con el servicio de atención al cliente.

3.  Una ligera deformación de la junta de la puerta es normal y no afecta a su función. Se recomienda alisar la junta de la puerta antes de insertarla en el aparato.

Calentar ligeramente la junta de la puerta con un secador de pelo o agua caliente y volver a darle forma con las manos.

## Reparación

5. Presionar metiendo toda la junta paso a paso en la ranura.



-  La junta de la puerta está montada.

## 4.2 Sustituir la bisagra plana

### Herramientas necesarias:

🔧 Punta Torx TX20      6,3 mm (1/4")      [00340865]

	<b>⚠️ ADVERTENCIA</b>
	<p><b>¡Aparatos pesados y voluminosos!</b> Espalda y lesiones musculares</p> <ul style="list-style-type: none"> <li>▶ La operación de extraer la puerta del aparato solo deben llevarla a cabo especialistas formados.</li> <li>▶ Para mover el aparato se necesitan dos personas.</li> <li>▶ Utilizar únicamente herramientas y equipos apropiados.</li> </ul>

	<b>⚠️ PRECAUCIÓN</b>
	<p><b>¡Bordes o cantos cortantes!</b> Peligro de cortes</p> <ul style="list-style-type: none"> <li>▶ Usar guantes de seguridad.</li> </ul>

	<b>⚠️ PRECAUCIÓN</b>
	<p><b>¡Zona de bisagra abierta!</b> Aplastamiento / atrapamiento de dedos</p> <ul style="list-style-type: none"> <li>▶ No acceder a la zona de la bisagra.</li> <li>▶ Usar guantes de seguridad.</li> </ul>

	<b>⚠️ PRECAUCIÓN</b>
	<p><b>¡Riesgo de que se caigan piezas debido a los tornillos aflojados!</b> Peligro de lesiones debido a piezas que caigan.</p> <ul style="list-style-type: none"> <li>▶ Asegure el componente para que no se caiga.</li> </ul>

	<b>⚠️ ATENCION</b>
	<p><b>¡Riesgo de que se caigan piezas debido a los tornillos aflojados!</b> Daños en otras partes del aparato o en el domicilio del consumidor, p. ej., en la parte inferior.</p> <ul style="list-style-type: none"> <li>▶ Asegure el componente para que no se caiga.</li> </ul>

### Requisito:

- ✔ El aparato está desconectado del suministro eléctrico.
- ✔ Se ha retirado la puerta del mueble. Véanse las instrucciones de montaje.
- ✔ La puerta está abierta.

### 4.2.1 Desmontar la bisagra plana

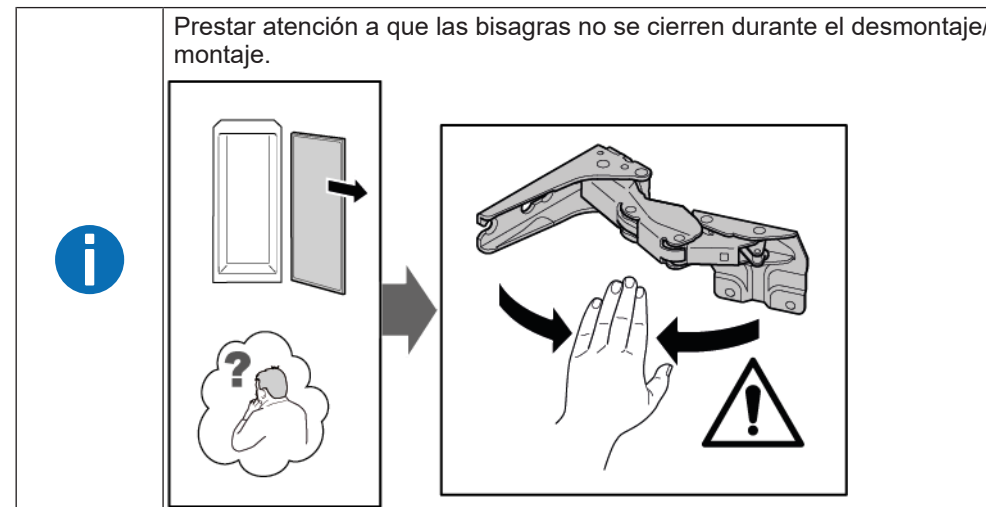

1. Retirar las dos tapas de las bisagras.

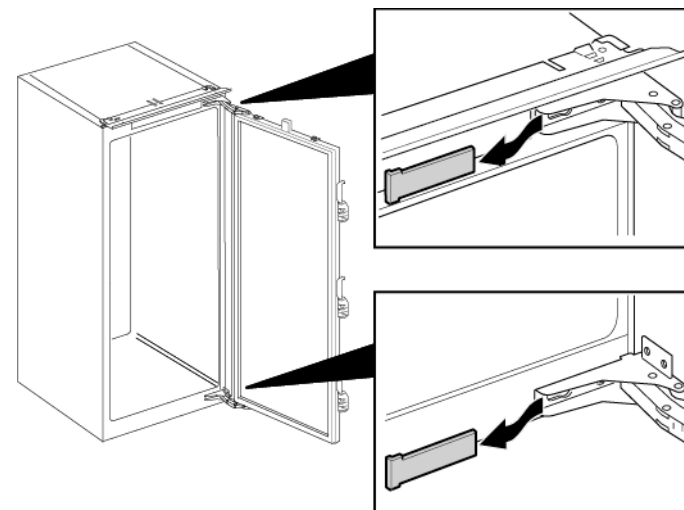



## Reparación

2. 1. Aflojar los cuatro tornillos (1).
2. Sacar la puerta y retirarla (2).

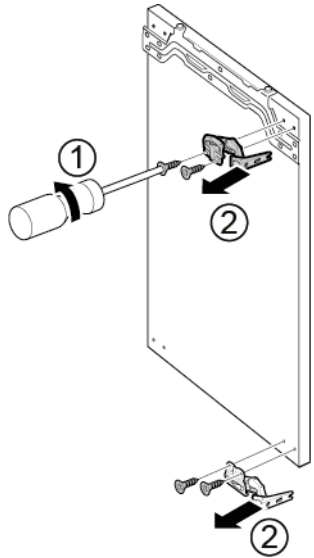

3. 1. Retirar los cuatro tornillos (1).
2. Retirar las bisagras (2).



 Se han retirado las bisagras.

### 4.2.2 Montar la bisagra plana

- ▶ Montar en orden inverso.

## 4.3 Sustituir la bisagra deslizante

### Herramientas necesarias:

🔧 Punta Torx TX20      6,3 mm (1/4")      [00340865]

	<b>⚠️ ADVERTENCIA</b>
	<p><b>¡Aparatos pesados y voluminosos!</b> Espalda y lesiones musculares</p> <ul style="list-style-type: none"> <li>▶ La operación de extraer la puerta del aparato solo deben llevarla a cabo especialistas formados.</li> <li>▶ Para mover el aparato se necesitan dos personas.</li> <li>▶ Utilizar únicamente herramientas y equipos apropiados.</li> </ul>

	<b>⚠️ PRECAUCIÓN</b>
	<p><b>¡Bordes o cantos cortantes!</b> Peligro de cortes</p> <ul style="list-style-type: none"> <li>▶ Usar guantes de seguridad.</li> </ul>

	<b>⚠️ PRECAUCIÓN</b>
	<p><b>¡Riesgo de que se caigan piezas debido a los tornillos aflojados!</b> Peligro de lesiones debido a piezas que caigan.</p> <ul style="list-style-type: none"> <li>▶ Asegure el componente para que no se caiga.</li> </ul>

	<b>⚠️ ATENCION</b>
	<p><b>¡Riesgo de que se caigan piezas debido a los tornillos aflojados!</b> Daños en otras partes del aparato o en el domicilio del consumidor, p. ej., en la parte inferior.</p> <ul style="list-style-type: none"> <li>▶ Asegure el componente para que no se caiga.</li> </ul>

### Requisito:

- ✔ El aparato está desconectado del suministro eléctrico.
- ✔ Se han separado la puerta del mueble y la del aparato. Véanse las instrucciones de montaje.

### 4.3.1 Desmontar la bisagra deslizante

- ▶ 1. Desatornillar los dos tornillos (1).
- ▶ 2. Retirar la bisagra superior (2).
- ▶ 3. Retirar la puerta (3).
- ▶ 4. Desatornillar los dos tornillos (4).
- ▶ 5. Retirar la bisagra inferior (5).

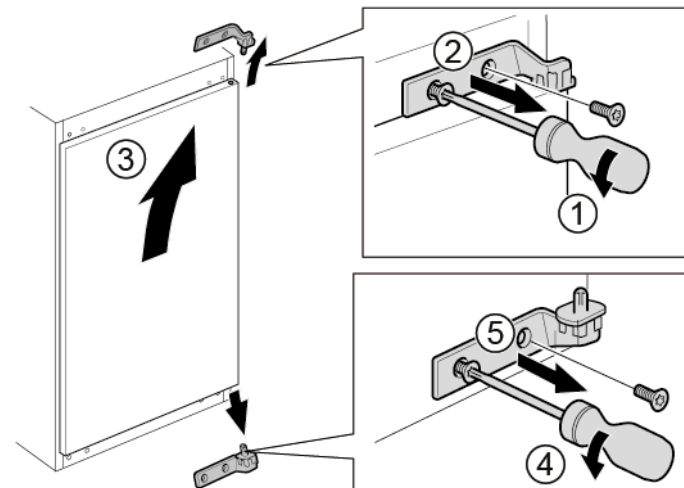

➡ Se han retirado las bisagras.

### 4.3.2 Montar la bisagra deslizante

- ▶ Montar en orden inverso.



## 4.4 Sustituir el estante

### Requisito:

- ✔ La puerta está abierta.

### 4.4.1 Extraer el estante

- ▶ Sacar el estante.



➡ Se ha retirado el estante.

### 4.4.2 Montar el estante

- ▶ Montar en orden inverso.

## 4.5 Sustituir el estante de la puerta

### Requisito:

- ✔ La puerta está abierta.

### 4.5.1 Extraer el estante de la puerta

- ▶ Sacar hacia arriba el estante de la puerta.

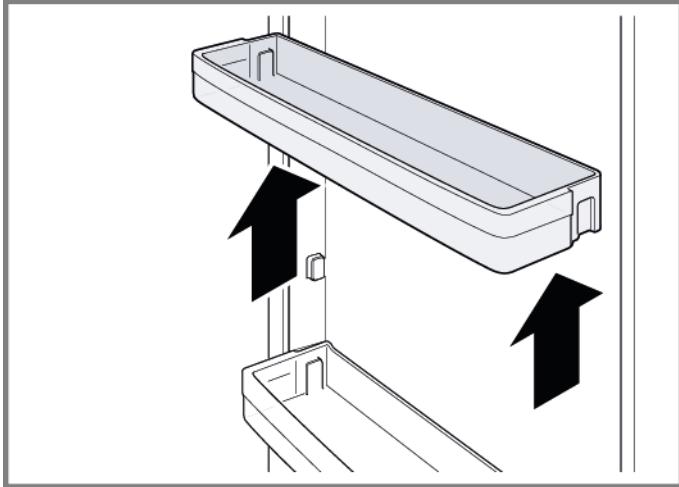

- ➡ Se ha retirado el estante de la puerta.

### 4.5.2 Montar el estante de la puerta

- ▶ Montar en orden inverso.

## 4.6 Sustituir el cajón para fruta y verdura

### Requisito:

- ✔ La puerta está abierta.

### 4.6.1 Extraer el cajón para fruta y verdura

1. Sacar el cajón para fruta y verdura tanto como se pueda.
2. 1. Levantar el cajón para fruta y verdura por delante (1).  
2. Extraer el cajón (2).



- ➡ Se ha retirado el cajón para fruta y verdura.

### 4.6.2 Montar el cajón para fruta y verdura

- ▶ Montar en orden inverso.

## 4.7 Sustituir la iluminación LED lateral

### Herramientas necesarias:

Ventosa Ø50 mm [00342224]



Su aparato cuenta con una iluminación LED exenta de mantenimiento.  
¡Solo el servicio de atención al cliente o los técnicos autorizados pueden reparar esta iluminación!



#### PELIGRO

#### ¡Riesgo de descarga eléctrica debido a piezas con tensión!

Peligro mortal por descarga eléctrica en caso de reparación inadecuada

- ▶ Las piezas eléctricas deberían ser reparadas por electricistas cualificados.
- ▶ Después de la reparación, encargar una prueba de seguridad conforme a VDE 0701 o los reglamentos específicos del país.



#### PELIGRO

#### ¡Riesgo de descarga eléctrica debido a partes con tensión!

Muerte por electrocución

- ▶ Desconectar el aparato de la red al menos 60 segundos antes de comenzar con la reparación.



#### PRECAUCIÓN

#### ¡Bordes o cantos cortantes!

Peligro de cortes

- ▶ Usar guantes de seguridad.

### Requisito:

- ✓ El aparato está desconectado del suministro eléctrico.
- ✓ La puerta está abierta.
- ✓ Se han extraído las baldas.

### 4.7.1 Retirar la iluminación LED lateral

1. Colocar dos ventosas en la tapa de la iluminación LED lateral.

2. Tirar de las ventosas hacia delante con un movimiento de rotación.

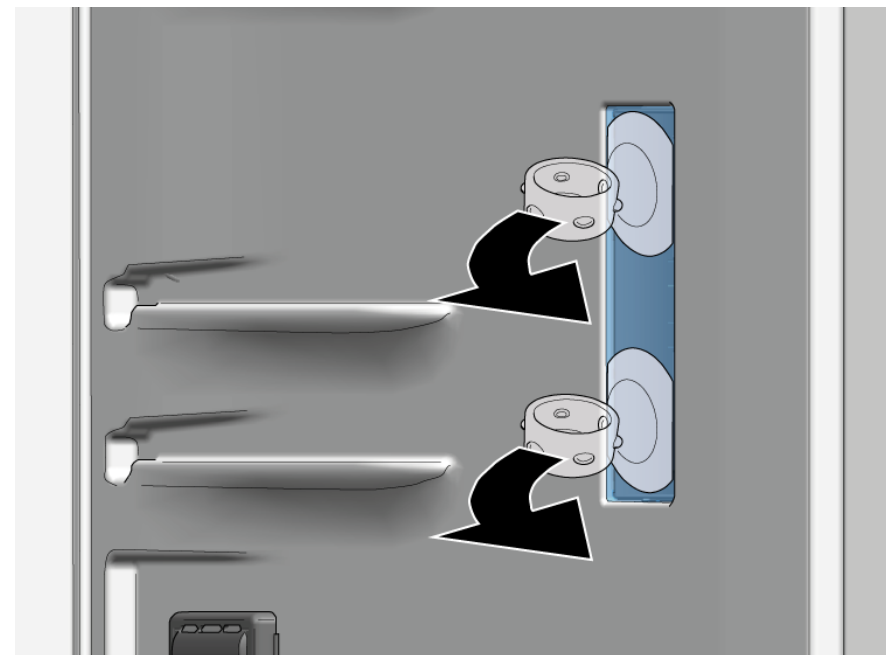

- ➔ Se ha retirado la tapa de la iluminación LED.

3. Extraer el módulo LED.

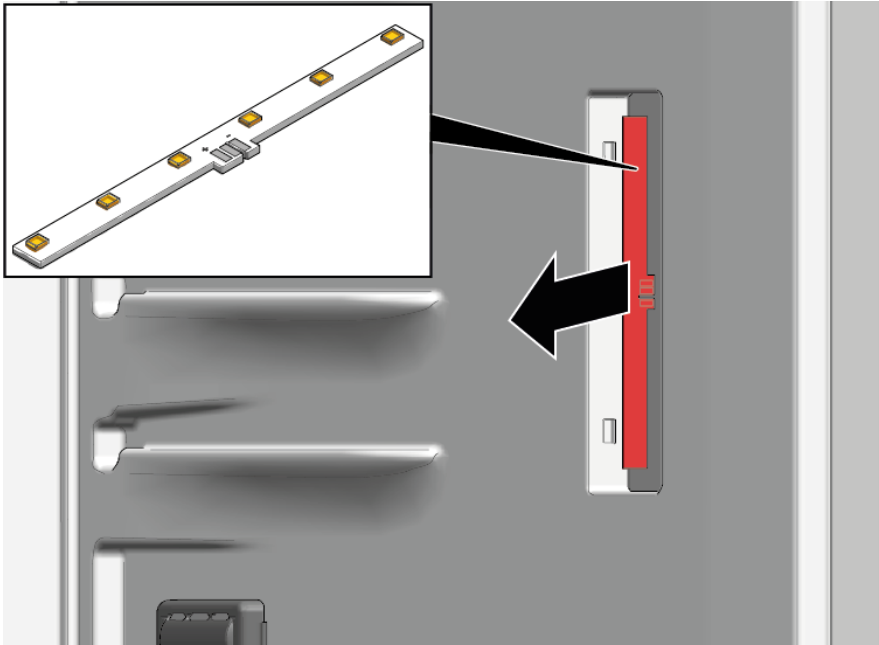

 Se ha retirado la iluminación LED lateral.

### 4.7.2 Montar la iluminación LED lateral



Debido a que los ganchos de la tapa de la lámpara se rompen fácilmente durante el proceso de extracción, el repuesto de la iluminación LED lateral es un juego que incluye el módulo y la tapa de la iluminación LED.

▶ Montar en orden inverso.

# Reparationsinformation - Kylskåp

 <b>Om detta dokument</b> .....	<b>355</b>
1.1 Viktig information.....	355
1.1.1 Syfte .....	355
1.2 Symbolförklaringar.....	355
1.2.1 Faronivåer .....	355
1.2.2 Risksymboler.....	355
1.2.3 Varningarnas struktur.....	356
1.2.4 Allmänna symboler.....	356
 <b>Säkerhet</b> .....	<b>357</b>
2.1 Allmänna säkerhetsanvisningar.....	357
2.1.1 Alla hushållsmaskiner.....	357
 <b>Verktyg och hjälpmedel</b> .....	<b>358</b>
 <b>Reparation</b> .....	<b>359</b>
4.1 Byta dörrpackning.....	359
4.1.1 Ta bort dörrpackning .....	359
4.1.2 Montera dörrpackning .....	359
4.2 Byta platt gångjärn.....	362
4.2.1 Ta bort platt gångjärn .....	362
4.2.2 Montera platt gångjärn .....	363
4.3 Byta glidgångjärn.....	364
4.3.1 Ta bort glidgångjärn .....	364
4.3.2 Montera glidgångjärn.....	364
4.4 Byta hylla .....	365
4.4.1 Ta bort hylla.....	365
4.4.2 Montera hylla.....	365
4.5 Byta dörrhylla .....	366
4.5.1 Ta bort dörrhylla.....	366
4.5.2 Montera dörrhylla .....	366
4.6 Byta frukt- och grönsakslåda .....	367
4.6.1 Ta bort frukt- och grönsakslåda.....	367
4.6.2 Montera frukt- och grönsakslåda .....	367
4.7 Byta LED-sidolampa .....	368
4.7.1 Ta bort LED-sidolampa.....	368
4.7.2 Montera LED-sidolampa .....	369

# **i** Om detta dokument

## 1.1 Viktig information

### 1.1.1 Syfte

Dessa reparationstips hjälper kunden att själv reparera maskiner enligt gällande ekodesignbestämmelser (som gäller 03/2021).





De innehåller information om hur vissa reservdelar ska bytas samt tillhörande varningar och risker.

Kontakta vår kundtjänst om du har frågor. Vi åtar oss bara ansvar för skador om reparationstipsen har följts korrekt.

## 1.2 Symbolförklaringar

### 1.2.1 Faronivåer

Varningsnivåerna består av en symbol och ett signalord. Signalordet visar hur allvarlig faran är.





Varningsnivå	Innebörd
	Om inte varningsmeddelandet följs kommer det att leda till dödsfall eller allvarliga personskador.
	Om inte varningsmeddelandet följs kan det leda till dödsfall eller allvarliga personskador.
	Om inte varningsmeddelandet följs kan det leda till lättare personskador.
	Om inte varningsmeddelandet följs kan det leda till materialskador.

Grafik 1: Faronivåer



### 1.2.2 Risksymboler

Risksymboler är symboler som visar typen av fara.

Följande risksymboler används i detta dokument:

Risksymbol	Innebörd
	Allmänt varningsmeddelande
	Fara på grund av elektrisk spänning
	Explosionsrisk
	Fara för skärskador
	Fara för krosskador

## i Om detta dokument

Risksymbol	Innebörd
	Fara på grund av heta ytor
	Fara på grund av starka magnetfält
	Fara på grund av icke-joniserande strålning

Grafik 2: Risksymboler

### 1.2.3 Varningarnas struktur

Varningar i detta dokument har ett standardiserat utseende och en standardiserad struktur.



	 <b>Farans typ och ursprung!</b> Möjliga konsekvenser av att faran/varningen ignoreras. ▶ Åtgärder och förbud för att förebygga faran.
--	--





Följande exempel visar en varning som varnar för elstötar från strömförande delar. Det står vilken åtgärd som förebygger faran.

	 <b>Risk för elstötar på grund av strömförande delar!</b> Dödsfall på grund av elstötar ▶ Koppla bort maskiner från elförsörjningen minst 60 sekunder innan reparationer påbörjas.
---	---

### 1.2.4 Allmänna symboler

Följande allmänna symboler används i detta dokument:

Allm. symbol	Innebörd
	Identifiering av ett särskilt tips (text och/eller bild)
	Identifiering av ett enkelt tips (endast text)

Allm. symbol	Innebörd
	Identifiering av en länk till en videohandledning
	Identifiering av verktyg som behövs
	Identifiering av villkor som måste vara uppfyllda
	Identifiering av ett tillstånd (om ..., så ...)
	Identifiering av ett resultat
[Start]	Identifiering av en tangent eller knapp
[00123456]	Identifiering av ett materialnummer
Status	Identifiering av text/fönster som visas (i maskinens display)

Grafik 3: Allmänna symboler



## 2.1 Allmänna säkerhetsanvisningar

### 2.1.1 Alla hushållsmaskiner

#### **Risk för elstötar på grund av strömförande delar!**

- Fel vid reparationer som berör elkomponenter kan orsaka elstötar!
- Koppla bort maskinen från elnätet minst 60 sekunder innan arbetet påbörjas.
- Låt utföra ett säkerhetstest efter reparationen, i enlighet med VDE 0701 eller landsspecifika regler.

#### **Risk för personskador på grund av vassa kanter!**

- Använd skyddshandskar.

#### **Risk för krosskador vid reparation, underhåll, felsökning och service på grund av tunga och rörliga komponenter**

- Använd skyddsskor.
- Säkra tunga komponenter så att de inte faller ner.
- Stick inte in kroppsdelar i rörliga komponenter.



#### **Risk för maskinens säkerhet/funktion!**

- Använd endast originaldelar.

#### **Risk för skador på komponenter känsliga för statisk elektricitet (ESD)!**

- Rör inte modulerna samt anslutningar och strömförande ledningar.

## Verktyg och hjälpmedel

Beteckning	Detaljer	Bilder
Skyddstrasa [00342013]	60 cm x 50 cm	
Sugkopp [00342224]	Ø50 mm	
Torxbits TX20 [00340865]	6,3 mm (1/4")	

## 4.1 Byta dörrpackning

### Förutsättning:

- ✅ Dörren är öppen.

### 4.1.1 Ta bort dörrpackning

1. Lossa dörrpackningen från spåret i högra och vänstra hörnet.

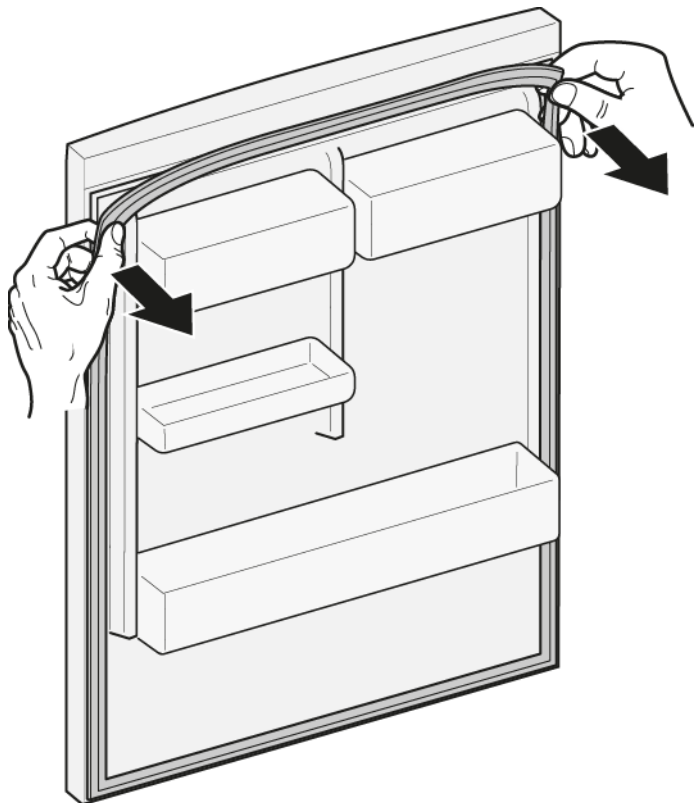

2. Dra ut dörrpackningen från spåret.



- ➡ Dörrpackningen har tagits bort.

### 4.1.2 Montera dörrpackning



Den nya dörrpackningens tjocklek kan avvika något från den gamla dörrpackningens tjocklek. Detta kommer inte påverka stängningsegenskaperna eller funktionen långsiktigt.

Om apparaten har justerbara gångjärn eller gångjärnsfästen kan du optimera stängningsegenskaperna senare.

Små sidohål i dörrpackningen fyller en funktion (krävs för ventilation). Dessa utgör inga tillverkningsfel.

## Reparation

1. Kontrollera om spåret för packningen har skador.

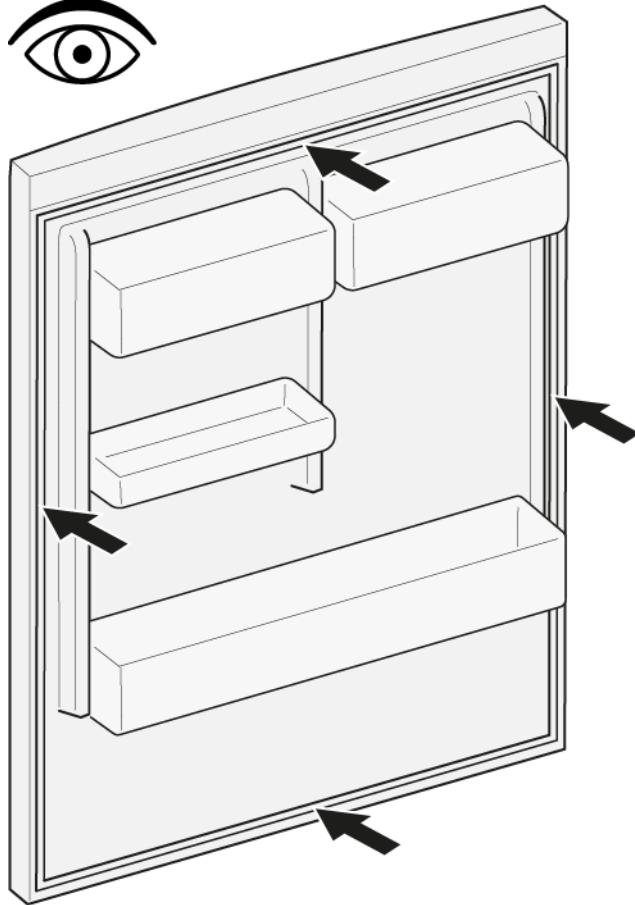

4. Tryck in packningens hörn längst upp och längst ner i spåret.

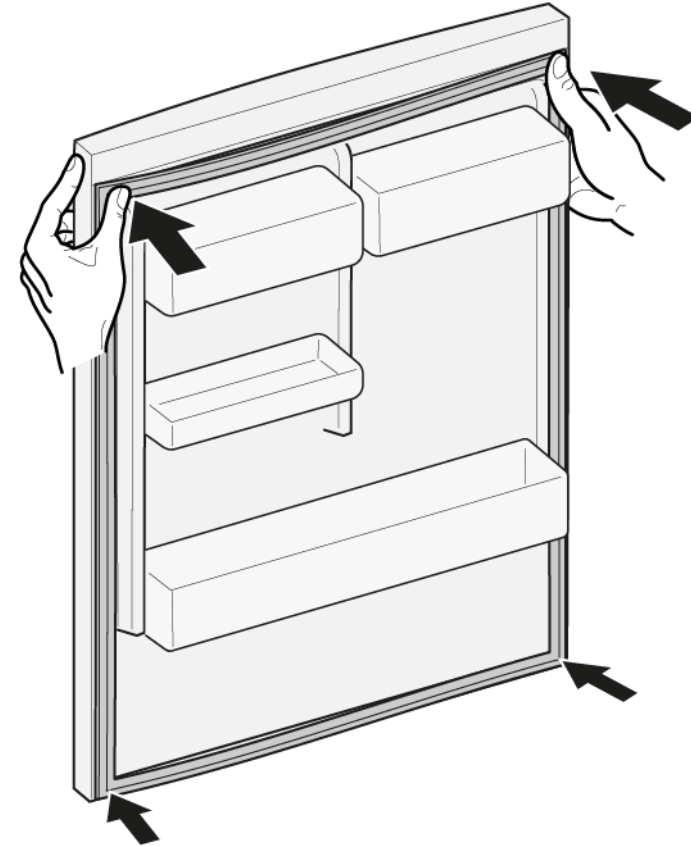

2.  Om spåret för packningen är skadat:
  - Kontakta kundtjänst.

3.  Viss deformation av dörrpackningen är normalt och påverkar inte packningens funktion. Det rekommenderas att man sträcker dörrpackningen innan den sätts in i apparaten.

Värm dörrpackningen med en hårtork eller hett vatten och forma om den med händerna.

## Reparation

5. Tryck in hela packningen i spåret bit för bit.



 Dörrpackningen är monterad.

## 4.2 Byta platt gångjärn

### Nödvändiga verktyg:

Torxbits TX20

6,3 mm (1/4")

[00340865]



#### ⚠ VARNING!

#### Tunga och skrymmande apparater!

Rygg- och muskelskador

- ▶ Låt endast utbildad personal ta bort dörren från apparaten.
- ▶ Det krävs två personer för att flytta apparaten.
- ▶ Använd endast passande verktyg och utrustning.



#### ⚠ FÖRSIKTIGT!

#### Vassa kanter!

Skärskador

- ▶ Använd skyddshandskar.



#### ⚠ FÖRSIKTIGT!

#### Öppna gångjärnsdelen!

Risk för att fingrar krossas/fastnar

- ▶ Stick inte in händerna i gångjärnsdelen.
- ▶ Använd skyddshandskar.



#### ⚠ FÖRSIKTIGT!

#### Risk för fallande delar på grund av lossade skruvar!

Personskador på grund av fallande delar.

- ▶ Säkra komponenter så att de inte faller ner.



#### OBS!

#### Risk för fallande delar på grund av lossade skruvar!

Materiella skador på andra delar av maskinen eller i kundens hem, t.ex. vid botten.

- ▶ Säkra komponenter så att de inte faller ner.

### Förutsättning:

- ✓ Apparaten är bortkopplad från strömförsörjning.
- ✓ Möbeldörren har tagits bort. Se Monteringsanvisning.
- ✓ Dörren är öppen.

## 4.2.1 Ta bort platt gångjärn

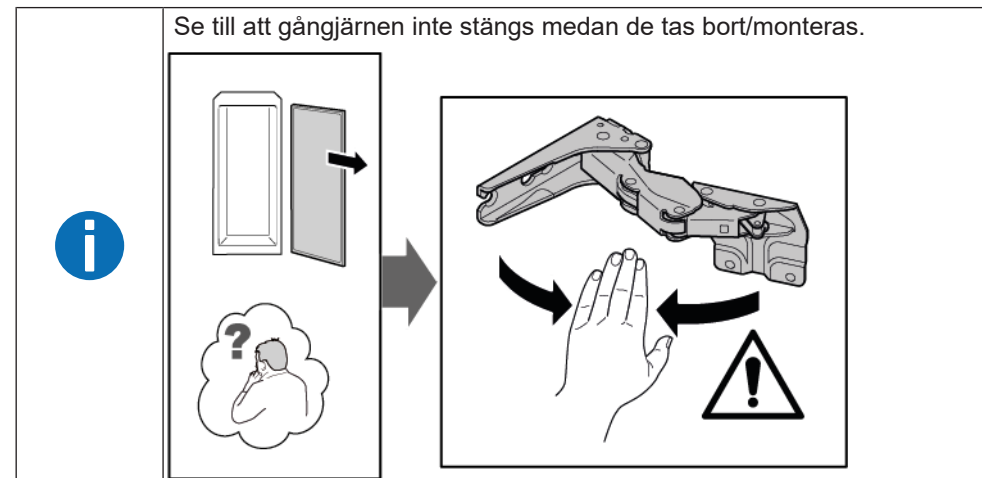

1. Ta bort de två gångjärnsskydden.

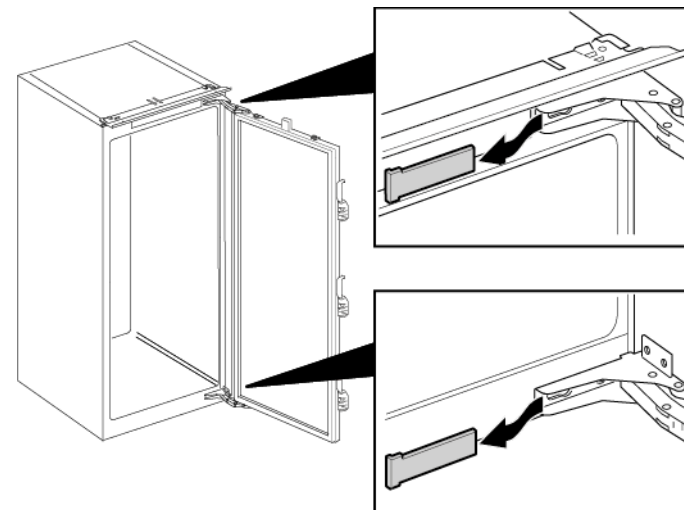

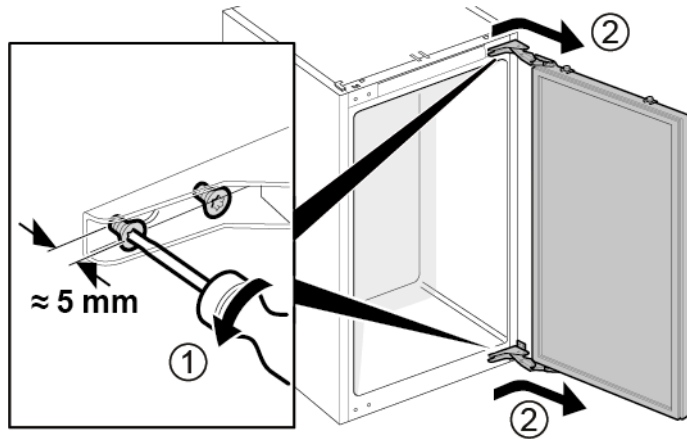

## Reparation

2. 1. Lossa på de fyra skruvarna (1).
2. Skjut ut och ta bort dörren (2).

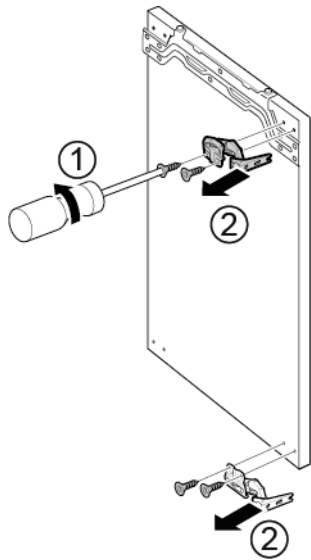

3. 1. Ta bort de fyra skruvarna (1).
2. Ta bort gångjärnen (2).



 Gångjärnen har tagits bort.

### 4.2.2 Montera platt gångjärn

- Montera i omvänd ordning.

## 4.3 Byta glidgångjärn

### Nödvändiga verktyg:

Torxbits TX20

6,3 mm (1/4")

[00340865]



#### ⚠ VARNING!

#### Tunga och skrymmande apparater!

Rygg- och muskelskador

- ▶ Låt endast utbildad personal ta bort dörren från apparaten.
- ▶ Det krävs två personer för att flytta apparaten.
- ▶ Använd endast passande verktyg och utrustning.



#### ⚠ FÖRSIKTIGT!

#### Vassa kanter!

Skärskador

- ▶ Använd skyddshandskar.



#### ⚠ FÖRSIKTIGT!

#### Risk för fallande delar på grund av lossade skruvar!

Personskador på grund av fallande delar.

- ▶ Säkra komponenter så att de inte faller ner.



#### OBS!

#### Risk för fallande delar på grund av lossade skruvar!

Materiella skador på andra delar av maskinen eller i kundens hem, t.ex. vid botten.

- ▶ Säkra komponenter så att de inte faller ner.

### Förutsättning:

- ✔ Apparaten är bortkopplad från strömförsörjning.
- ✔ Möbeldörren och apparatens dörr är separerade. Se Monteringsanvisning.

### 4.3.1 Ta bort glidgångjärn

- ▶ 1. Skruva ur de två skruvarna (1).
- ▶ 2. Ta bort det övre gångjärnet (2).
- ▶ 3. Ta bort dörren (3).
- ▶ 4. Skruva ur de två skruvarna (4).
- ▶ 5. Ta bort det nedre gångjärnet (5).

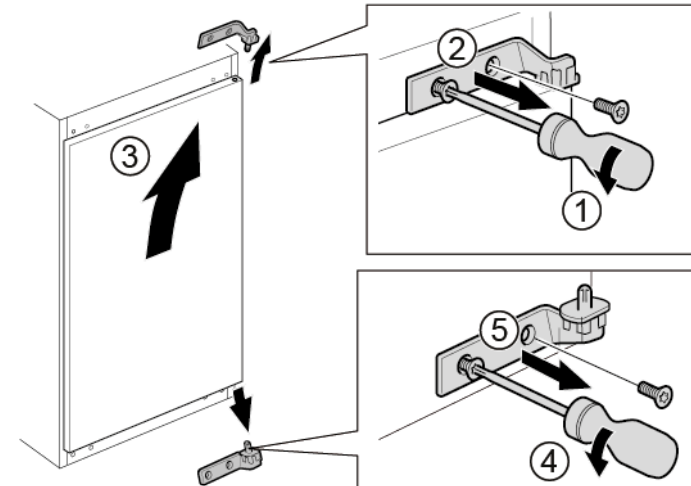

➡ Gångjärnen har tagits bort.

### 4.3.2 Montera glidgångjärn

- ▶ Montera i omvänd ordning.



## 4.4 Byta hylla

### Förutsättning:

- ✔ Dörren är öppen.

### 4.4.1 Ta bort hylla

- ▶ Dra ut hyllan.



- ➡ Hyllan har tagits bort.

### 4.4.2 Montera hylla

- ▶ Montera i omvänd ordning.

## 4.5 Byta dörrhylla

### Förutsättning:

- ✔ Dörren är öppen.

### 4.5.1 Ta bort dörrhylla

- ▶ Lyft dörrhyllan uppåt.



➡ Dörrhyllan har tagits bort.

### 4.5.2 Montera dörrhylla

- ▶ Montera i omvänd ordning.

## 4.6 Byta frukt- och grönsakslåda

### Förutsättning:

- ✔ Dörren är öppen.

### 4.6.1 Ta bort frukt- och grönsakslåda

1. Dra ut frukt- och grönsaksfacket så långt det går.
2. 1. Lyft upp frukt- och grönsaksfacket framtill (1).  
2. Ta bort facket (2).

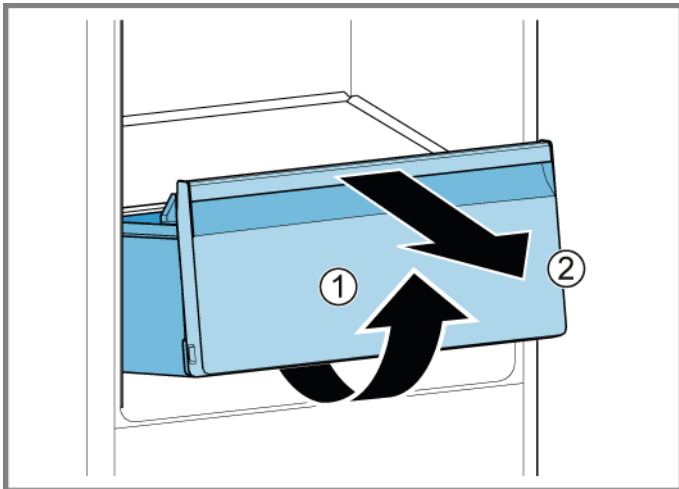

- ➡ Frukt- och grönsaksfacket har tagits bort.

### 4.6.2 Montera frukt- och grönsakslåda

- ▶ Montera i omvänd ordning.

## 4.7 Byta LED-sidolampa

### Nödvändiga verktyg:

Sugkopp Ø50 mm [00342224]



Din apparat har en underhållsfri LED-lampa.  
Dessa lampor får endast bytas av kundtjänst eller auktoriserade tekniker!



#### **FARA!**

#### Risk för elstötar på grund av strömförande delar!

Livs fara på grund av elstötar vid felaktiga reparationer

- ▶ Elektriska delar ska repareras av behörig elektriker.
- ▶ Låt utföra ett säkerhetstest efter reparationen, i enlighet med VDE 0701 eller landsspecifika regler.



#### **FARA!**

#### Risk för elstötar på grund av strömförande delar!

Dödsfall på grund av elstötar

- ▶ Koppla bort maskiner från elförsörjningen minst 60 sekunder innan reparationer påbörjas.



#### **FÖRSIKTIGT!**

#### Vassa kanter!

Skärskador

- ▶ Använd skyddshandskar.

### Förutsättning:

- ✓ Apparaten är bortkopplad från strömförsörjning.
- ✓ Dörren är öppen.
- ✓ Hyllorna har tagits bort.

### 4.7.1 Ta bort LED-sidolampa

1. Sätt två sugkoppar på LED-sidolampshöljet.

2. Dra sugkopparna framåt i en vridrörelse.

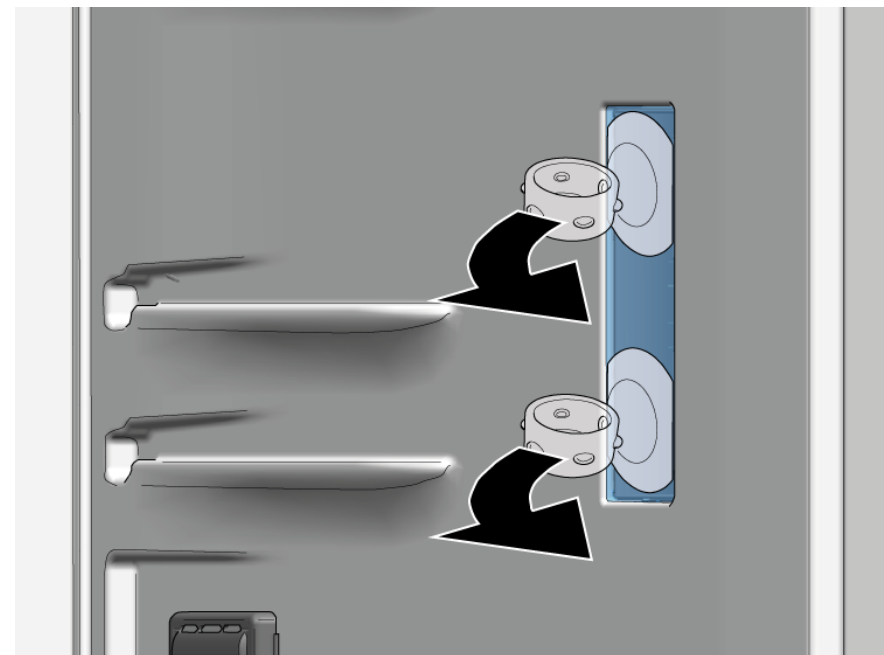

- ➡ LED-lampshöljet har tagits bort.

## Reparation

3. Ta bort LED-modulen.



 LED-sidolampan har tagits bort.

### 4.7.2 Montera LED-sidolampa



På grund av att lamphöljets hakar lätt går sönder vid borttagningen är reservdelen LED-sidolampa ett set som inkluderar LED-modul och lamphölje.

► Montera i omvänd ordning.

# Onarım İpuçları - Buzdolabı

 <b>Bu doküman hakkında</b> .....	<b>371</b>
1.1 Önemli bilgi .....	371
1.1.1 Amacı.....	371
1.2 Sembollerinin açıklaması .....	371
1.2.1 Tehlike kademeleri .....	371
1.2.2 Tehlike sembolleri .....	371
1.2.3 İkaz bilgilerinin yapısı .....	372
1.2.4 Genel semboller.....	372
 <b>Güvenlik</b> .....	<b>373</b>
2.1 Genel Güvenlik bilgileri .....	373
2.1.1 Tüm ev gereçleri .....	373
 <b>Ekipman ve yardım</b> .....	<b>374</b>
 <b>Onarım</b> .....	<b>375</b>
4.1 Kapı contasının değiştirilmesi .....	375
4.1.1 Kapı contasının çıkartılması .....	375
4.1.2 Kapı contasının takılması .....	375
4.2 Yassı menteşenin değiştirilmesi.....	378
4.2.1 Yassı menteşenin çıkartılması .....	378
4.2.2 Yassı menteşenin takılması .....	379
4.3 Sürgülü menteşenin değiştirilmesi .....	380
4.3.1 Sürgülü menteşenin çıkartılması .....	380
4.3.2 Sürgülü menteşenin takılması .....	380
4.4 Raf yüzeyinin değiştirilmesi .....	381
4.4.1 Raf yüzeyinin çıkartılması .....	381
4.4.2 Raf yüzeyinin takılması.....	381
4.5 Kapı rafının değiştirilmesi .....	382
4.5.1 Kapı rafının çıkartılması .....	382
4.5.2 Kapı rafının takılması .....	382
4.6 Meyve-sebze kabının değiştirilmesi .....	383
4.6.1 Meyve-sebze kabının çıkartılması .....	383
4.6.2 Meyve-sebze kabının takılması .....	383
4.7 LED yan ışığının değiştirilmesi .....	384
4.7.1 LED yan ışığının çıkartılması .....	384
4.7.2 LED yan ışığının takılması .....	385

# **i** Bu doküman hakkında

## 1.1 Önemli bilgi

### 1.1.1 Amacı

Bu onarım ipuçları, tüketicinin cihazları, geçerli eko-tasarım yönetmeliğine göre (03/2021 itibarıyla) kendi başına onarması için destek sunar.

İpuçları, ilgili uyarı ve riskler de dahil olmak üzere tanımlanmış yedek parçaların nasıl değiştirilmesi gerektiğine dair bilgiler içerir.

Sorularınız varsa, lütfen müşteri hizmetlerimizle irtibata geçin. Yalnızca onarım ipuçlarına gerektiği gibi uyulduğu takdirde hasarlar için sorumluluk üstleniriz.

## 1.2 Sembollerinin açıklaması

### 1.2.1 Tehlike kademeleri

Tehlike kademeleri bir sembolden ve bir sinyal kelimesinden oluşur. Sinyal kelimesi tehlikenin şiddetini ve önemini tanımlar.





Tehlike kademesi	Anlamı
 <b>TEHLİKE</b>	İkaz bilgisinin dikkate alınmaması ölüme veya ağır yaralanmalara sebep olur.
 <b>UYARI</b>	İkaz bilgisinin dikkate alınmaması ölüme veya ağır yaralanmalara sebep olabilir.
 <b>DİKKAT</b>	İkaz bilgisinin dikkate alınmaması hafif yaralanmalara sebep olabilir.
<b>DİKKATI</b>	İkaz bilgisinin dikkate alınmaması maddi hasarların oluşmasına sebep olabilir.

Tablo 1: Tehlike kademeleri



### 1.2.2 Tehlike sembolleri

Tehlike sembolleri, tehlike türü hakkında bilgi veren anlamlı resimsel gösterimlerdir.

Bu dokümanda aşağıdaki tehlike sembolleri kullanılmıştır:

Tehlike sembolü	Anlamı
	Genel ikaz bilgisi
	Elektrik geriliminden kaynaklanan tehlike
	Patlamadan kaynaklanan tehlike
	Kesmeden dolayı yaralanma tehlikesi
	Sıkışıp ezilmeden dolayı yaralanma tehlikesi

## **i** Bu doküman hakkında

Tehlike sembolü	Anlamı
	Sıcak yüzeylerden kaynaklanan tehlike
	Güçlü elektromanyetik alan tehlikesi
	İyonizasyon olmayan ışınlardan kaynaklanan tehlike

Tablo 2: Tehlike sembolleri

### 1.2.3 İkaz bilgilerinin yapısı

Bu dokümandaki ikaz bilgilerinin standart olarak görünüşü ve yapısı aynıdır.



	<b>⚠ TEHLİKE</b> <b>Tehlikenin türü ve kaynağı!!</b> Tehlike / ikaz bilgisinin dikkate alınmamasının sonucu. ► Tehlikeye karşı korunmak için yapılacak işlem ve yasaklar.
--	--







Aşağıdaki örnekte, gerilim ileten parçalar nedeniyle oluşabilecek elektrik çarpması tehlikesi hakkında uyarıda bulunan bir ikaz bilgisi gösterilmiştir. Tehlikeyi önlemek için alınması gereken önlemler belirtilmiştir.

	<b>⚠ TEHLİKE</b> <b>Gerilim ileten parçalar nedeniyle elektrik çarpması tehlikesi!!</b> Elektrik çarpması sebebiyle ölüm ► Onarıma başlamadan önce cihazın elektrik şebeke bağlantısını en az 60 saniye süreyle sökün.
--	---

### 1.2.4 Genel semboller

Bu dokümanda aşağıdaki genel semboller kullanılmıştır:

Genel sembol	Anlamı
	Özel ipucu işareti (metin ve/veya grafik)
	Basit ipucu işareti (yalnızca metin)
	Video linki işareti

Genel sembol	Anlamı
	Gerekli araçlar işareti
	Ön koşulların işareti
	Koşul işareti (... olursa .... olur)
	Sonuç işareti
	Tuş veya düğme işareti
	Malzeme numarası işareti
	Gösterilen yazı / ekran işareti (cihaz ekranındaki)

Tablo 3: Genel semboller



## **2.1 Genel Güvenlik bilgileri**

### **2.1.1 Tüm ev gereçleri**

#### **Gerilim ileten parçalar nedeniyle elektrik çarpması tehlikesi!**

- Elektrikli bileşenlerde yapılan onarımlarda hatalar, elektrik çarpmasına neden olabilir!
- Cihaz çalışmalara başlamadan en az 60 saniye önce elektrik şebekesinden ayrılmalıdır.
- Onarım sonrasında VDE 0701 veya ülkeye özel düzenlemeler uyarınca bir güvenlik testi gerçekleştirilmelidir.

#### **Keskin kenarlar nedeniyle yaralanma tehlikesi!**

- Koruyucu eldiven kullanılmalıdır.

#### **Ağır ve hareketli parçaların onarım, bakım, hata arama ve servis işlemlerinde yaratabileceği ezilme riskleri**

- Koruyucu ayakkabı giyin.
- Yere düşmemesi için ağır parçaları emniyete alın.
- Hareketli parçaların arasına gövde parçaları koymayın.



#### **Cihaz güvenliğinde / fonksiyonda tehlike!**

- Yalnızca orijinal parçalar kullanılmalıdır.

#### **Elektrostatik hassasiyeti olan bileşenlerde hasar tehlikesi (ESD)!**

- Bağlantılar ve iletken yolları da dahil olmak üzere modüllere dokunmayın.

## Ekipman ve yardım

Tanımlama	Detaylar	Görüntüler
Koruyucu bez [00342013]	60 cm x 50 cm	
Vantuz [00342224]	Ø50 mm	
Torx Bit TX20 [00340865]	6,3 mm (1/4")	

## 4.1 Kapı contasının değiştirilmesi

Ön koşul:

- ✓ Kapı açık.

### 4.1.1 Kapı contasının çıkartılması

1. Kapı contasını sağ ve sol köşedeki oluklardan kurtarın.

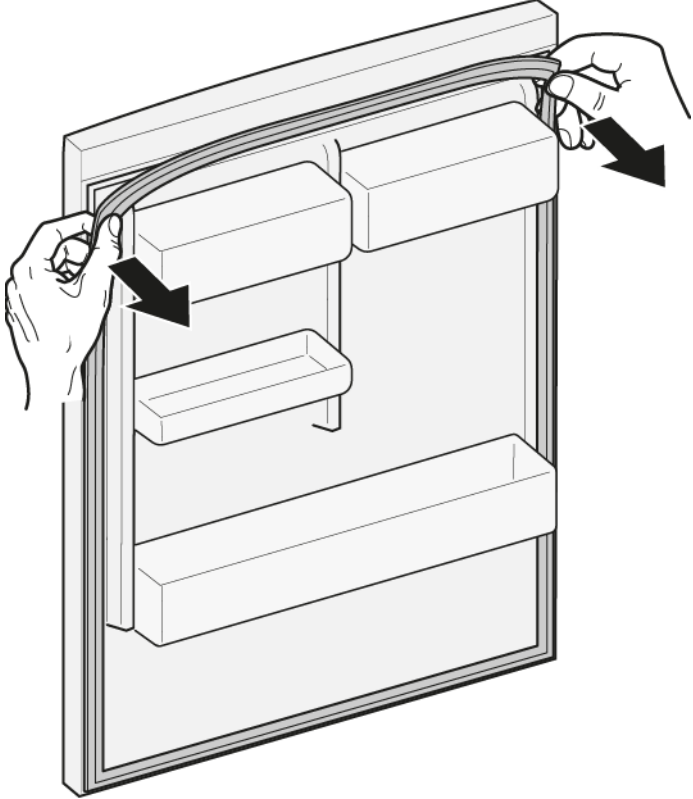

2. Kapı contasını oluktan dışarı çekin.

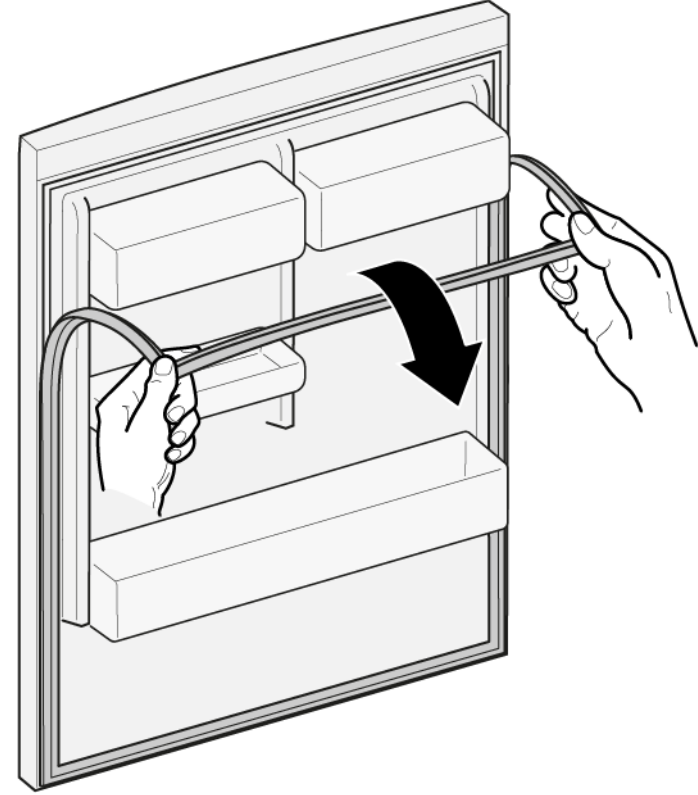

- ➡ Kapı contası çıkartılmıştır.

### 4.1.2 Kapı contasının takılması



Yeni kapı contasının kalınlığı, eski kapı contasının kalınlığından biraz farklı olabilir. Bu, kapının kapanma özelliğini ve uzun süreli işlevini etkilemez.

Cihazınızda ayarlanabilir menteşeler veya menteşe ekleri varsa, kapının kapanma özelliğini daha sonra optimize edebilirsiniz.

Kapı contasındaki küçük yan delikler işlevseldir (havalandırma için gereklidir). Bunlar üretim hatası değildir.

1. Conta için oluğu hasar bakımından kontrol edin.

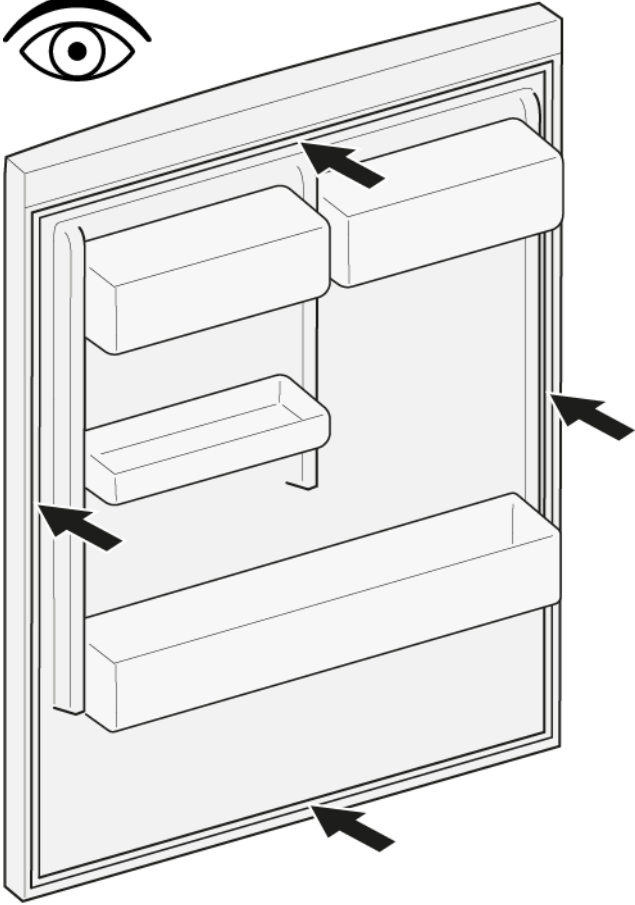

4. Contanın köşelerini üstten ve alttan oluğa itin.

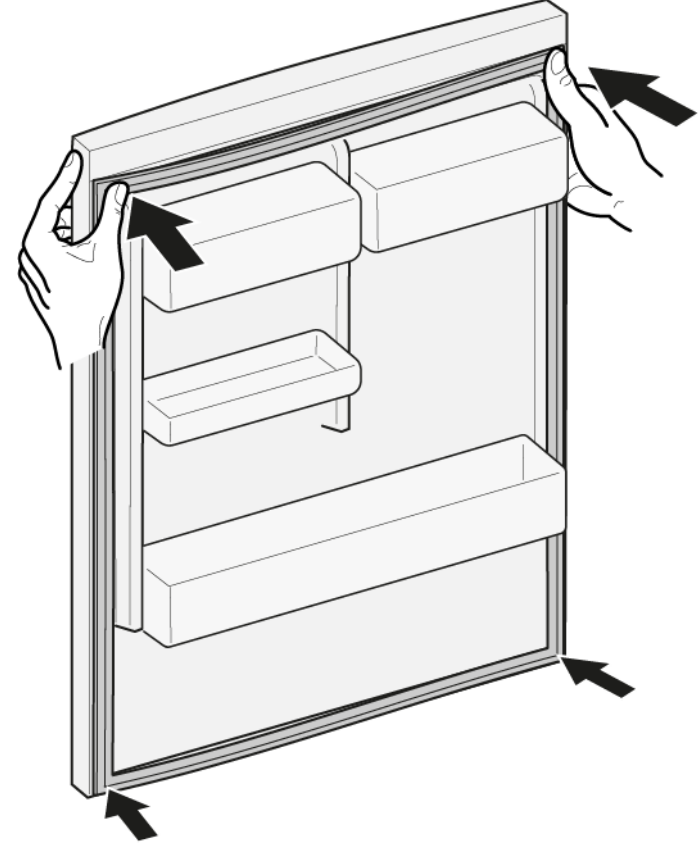



2.  Conta için oluk hasarlı ise,  
- Müşteri hizmetleriyle irtibata geçin.

3.  Kapı contasında hafif deformasyon normaldir ve contanın işlevini etkilemez. Kapı contasını cihaza yerleştirmeden önce contanın düzleştirilmesi önerilir.

Kapı contasını bir saç kurutma makinesi veya sıcak suyla ısıtın ve manuel olarak şekillendirin.

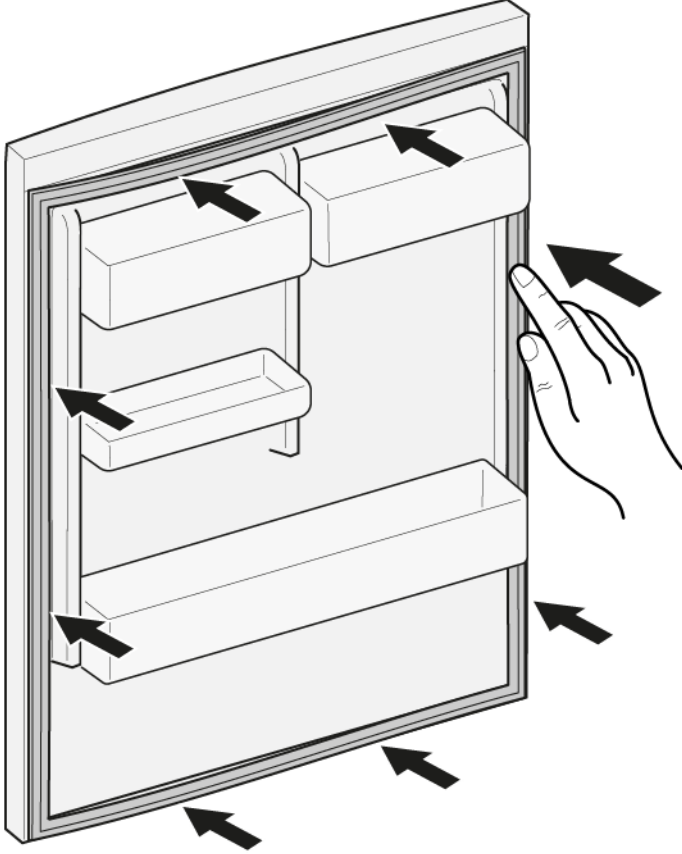
5. Contanın tamamını adım adım oluğun içine bastırın.



 Kapı contası takılmıştır.

## 4.2 Yassı menteşenin değiştirilmesi

Özel yardımcı ekipman:

Torx Bit TX20

6,3 mm (1/4")

[00340865]



### UYARI

#### Ağır, büyük cihazlar!

Sırt ve kas yaralanmaları

- ▶ Cihaz kapısını çıkarma işlemi sadece eğitimli uzmanlar tarafından gerçekleştirilmelidir.
- ▶ Cihazı hareket ettirmek için iki kişi gereklidir.
- ▶ Sadece uygun aletler ve ekipmanlar kullanın.



### DİKKAT

#### Keskin köşeler!

Kesik yaralanmaları

- ▶ Koruyucu eldiven kullanılmalıdır.



### DİKKAT

#### Açık menteşe bölgesi!

Parmakların ezilmesi / sıkışması

- ▶ Menteşe bölgesine elinizi sokmayın.
- ▶ Koruyucu eldiven kullanılmalıdır.



### DİKKAT

#### Vidaların gevşetilmesi nedeniyle parçaların düşme tehlikesi!

Düşen parçalar nedeniyle yaralanma.

- ▶ Bileşenleri düşmeye karşı emniyete alın.



### DİKKAT!

#### Vidaların gevşetilmesi nedeniyle parçaların düşme tehlikesi!

Cihazın diğer parçalarında veya müşterinin evinde (örn. zemin) hasarlar.

- ▶ Bileşenleri düşmeye karşı emniyete alın.

Ön koşul:

- ✔ Cihazın fişi çekilir.
- ✔ Mobilya kapısı çıkartılmıştır. Bkz. Montaj Talimatı.
- ✔ Kapı açık.

## 4.2.1 Yassı menteşenin çıkartılması

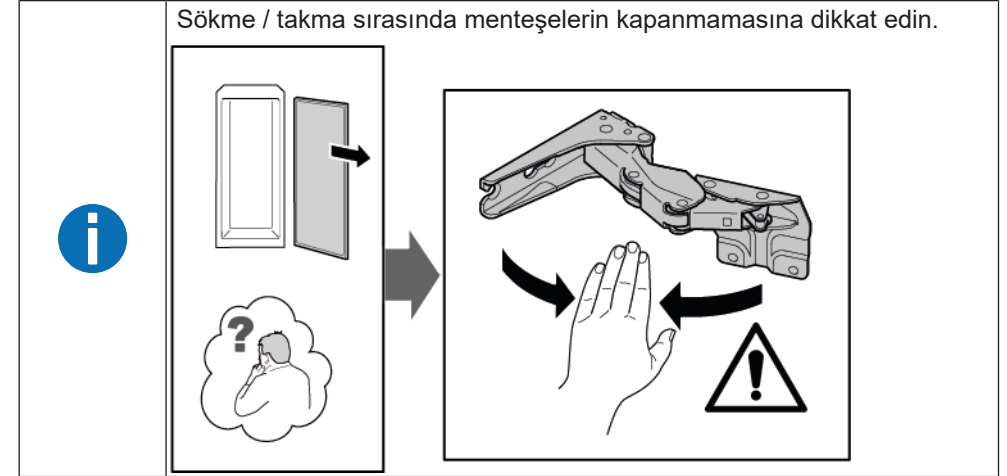

1. İki menteşe kapağını çıkartın.

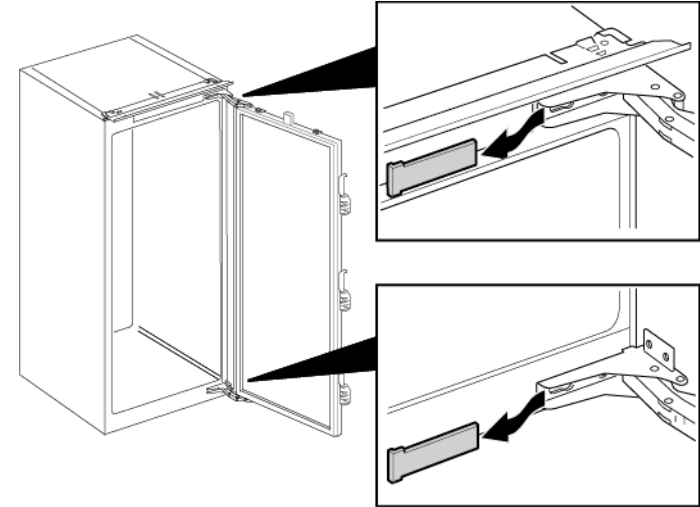

1. Dört vidayı gevşetin (1).
2. Kapıyı dışarı kaydırarak çıkartın (2).

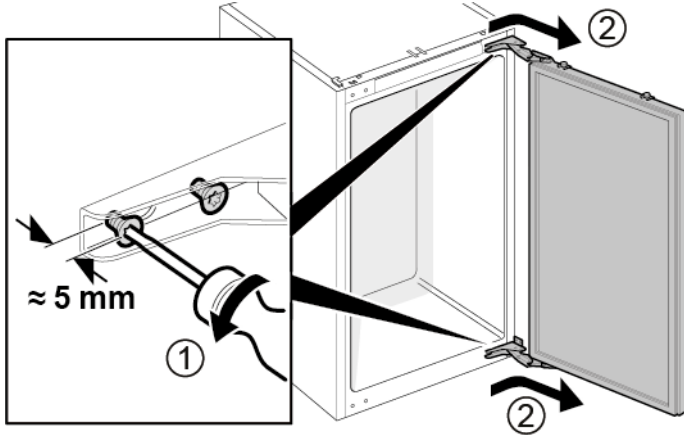

1. Dört vidayı sökün (1).
2. Mentşeleri çıkartın (2).

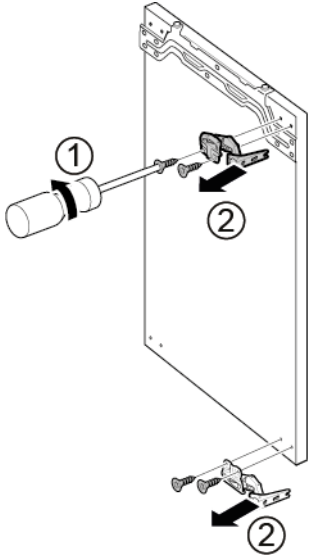

➡ Mentşeler çıkartılmıştır.

## 4.2.2 Yassı menteşenin takılması

- ▶ Ters sıra ile monte edin.

## 4.3 Sürgülü menteşenin değiştirilmesi

Özel yardımcı ekipman:

Torx Bit TX20

6,3 mm (1/4")

[00340865]



### UYARI

#### Ağır, büyük cihazlar!

Sırt ve kas yaralanmaları

- ▶ Cihaz kapısını çıkarma işlemi sadece eğitimli uzmanlar tarafından gerçekleştirilmelidir.
- ▶ Cihazı hareket ettirmek için iki kişi gereklidir.
- ▶ Sadece uygun aletler ve ekipmanlar kullanın.



### DİKKAT

#### Keskin köşeler!

Kesik yaralanmaları

- ▶ Koruyucu eldiven kullanılmalıdır.



### DİKKAT

#### Vidaların gevşetilmesi nedeniyle parçaların düşme tehlikesi!

Düşen parçalar nedeniyle yaralanma.

- ▶ Bileşenleri düşmeye karşı emniyete alın.



### DİKKAT!

#### Vidaların gevşetilmesi nedeniyle parçaların düşme tehlikesi!

Cihazın diğer parçalarında veya müşterinin evinde (örn. zemin) hasarlar.

- ▶ Bileşenleri düşmeye karşı emniyete alın.

Ön koşul:

- ✔ Cihazın fişi çekilir.
- ✔ Mobilya kapısı ve cihaz kapısı ayrıdır. Bkz. Montaj Talimatı.

## 4.3.1 Sürgülü menteşenin çıkartılması

- ▶ 1. Vidaları sökün (1).
- ▶ 2. Üst menteşeyi çıkartın (2).
- ▶ 3. Kapıyı sökün (3).
- ▶ 4. Vidaları sökün (4).
- ▶ 5. Alt menteşeyi (5) çıkarın.

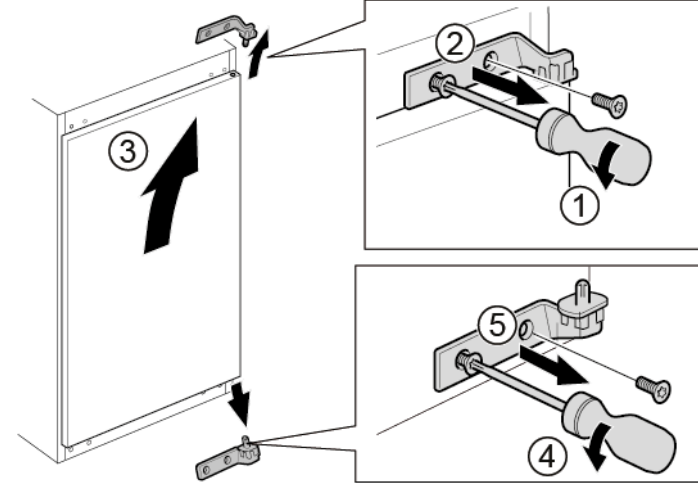

➔ Menteşeler çıkartılmıştır.

## 4.3.2 Sürgülü menteşenin takılması

- ▶ Ters sıra ile monte edin.



## 4.4 Raf yüzeyinin değiştirilmesi

Ön koşul:

- ✔ Kapı açık.

### 4.4.1 Raf yüzeyinin çıkartılması

- ▶ Raf yüzeyini dışarı çekin.

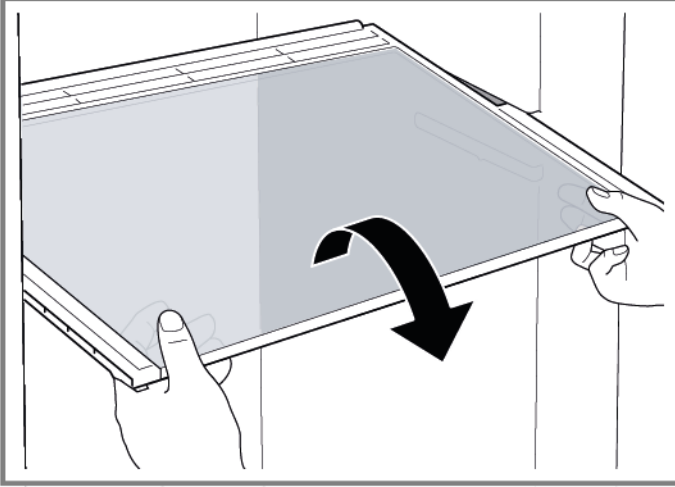

- ➡ Raf yüzeyi çıkartılmıştır.

### 4.4.2 Raf yüzeyinin takılması

- ▶ Ters sıra ile monte edin.

## 4.5 Kapı rafının değiştirilmesi

Ön koşul:

- ✔ Kapı açık.

### 4.5.1 Kapı rafının çıkartılması

- ▶ Kapı rafını yukarıya doğru kaldırın.

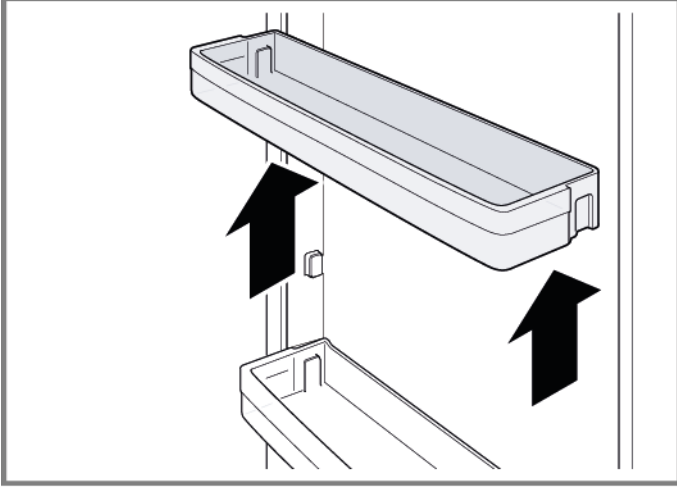

➡ Kapı rafı çıkartılmıştır.

### 4.5.2 Kapı rafının takılması

- ▶ Ters sıra ile monte edin.

## 4.6 Meyve-sebze kabının deęiřtirilmesi

Ön kopul:

- ✓ Kapı açık.

### 4.6.1 Meyve-sebze kabının çıkartılması

1. Meyve-sebze kabını gidebildiđi yere kadar dıřarı çekin.
2. 1. Meyve-sebze kabını ön kısımdan kaldırın (1).  
2. Kabı çıkarın (2).

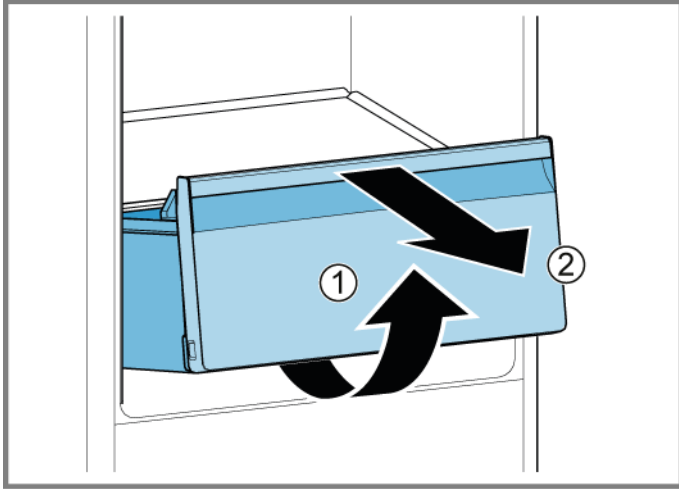

- ➔ Meyve-sebze kabı çıkartılmıştır.

### 4.6.2 Meyve-sebze kabının takılması

- ▶ Ters sıra ile monte edin.

## 4.7 LED yan ışığının değiştirilmesi

Özel yardımcı ekipman:

Vantuz Ø50 mm [00342224]

**i** Cihazınızda bakım gerektirmeyen bir LED ışık bulunmaktadır.  
Bu ışıklar sadece müşteri hizmetleri veya yetkili teknisyenler tarafından değiştirilebilir!

**! TEHLİKE**  
**Gerilim ileten parçalar nedeniyle elektrik çarpması tehlikesi!!**  
Onarımın düzgün yapılmaması nedeniyle elektrik çarpması sonucu hayati tehlike

- ▶ Elektrikli parçaların onarımı kalifiye bir elektrik uzmanı tarafından gerçekleştirilmelidir.
- ▶ Onarım sonrasında VDE 0701 veya ülkeye özel düzenlemeler uyarınca bir güvenlik testi gerçekleştirilmelidir.

**! TEHLİKE**  
**Gerilim ileten parçalar nedeniyle elektrik çarpması tehlikesi!!**  
Elektrik çarpması sebebiyle ölüm

- ▶ Onarıma başlamadan önce cihazın elektrik şebeke bağlantısını en az 60 saniye süreyle sökün.

**! DİKKAT**  
**Keskin köşeler!**  
Kesik yaralanmaları

- ▶ Koruyucu eldiven kullanılmalıdır.

Ön koşul:

- ✓ Cihazın fişi çekilir.
- ✓ Kapı açık.
- ✓ Raflar çıkartılmıştır.

### 4.7.1 LED yan ışığının çıkartılması

1. LED yan ışık kapağına iki emme kabı yapıştırın.

2. Emme kaplarını döndürme hareketi uygulayarak öne doğru çekin.

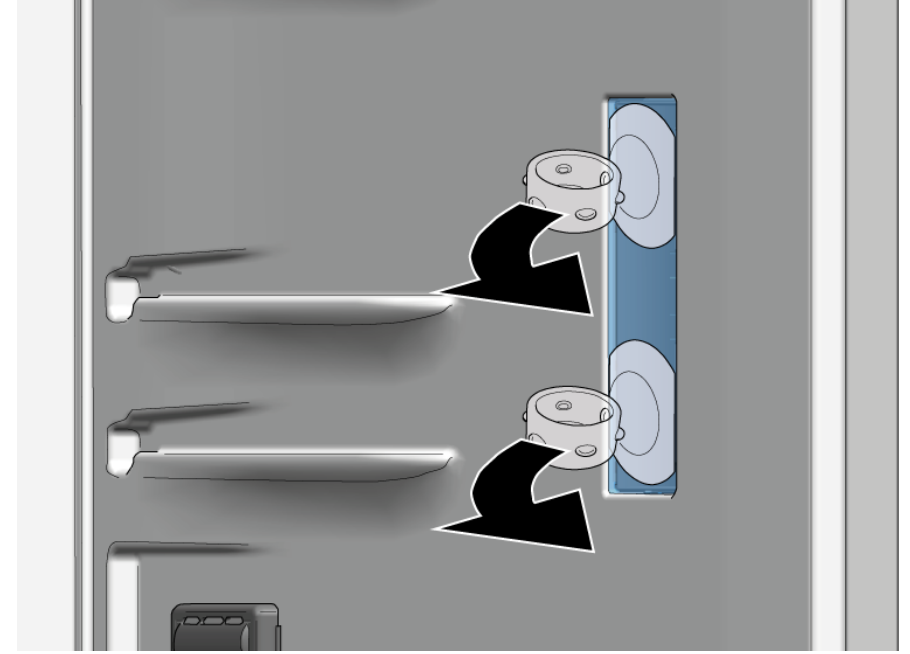

➔ LED ışık kapağı çıkartılmıştır.

3. LED modülünü çıkartın.

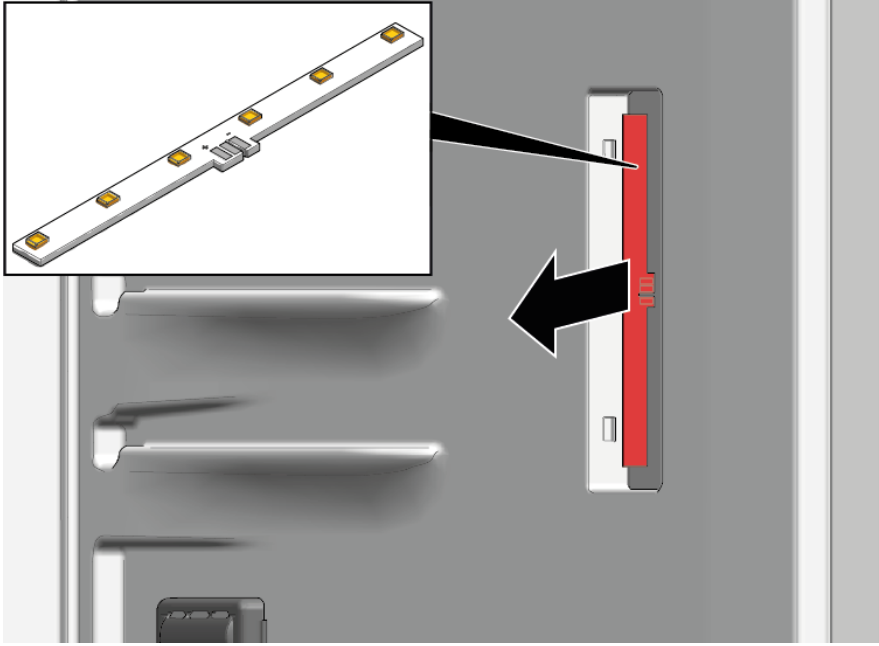

 LED yan ışığı çıkartılmıştır.

#### 4.7.2 LED yan ışığının takılması



Sökme işlemi sırasında lamba kapağı kancaları kolayca kırılabilirdiğinden, LED yan ışık yedek parça seti, LED modülünü ve ışık kapağını içermektedir.

► Ters sıra ile monte edin.

# Informationen für private Haushalte zur Erfassung von Elektro- und Elektronikgeräten, die zu Abfall geworden sind („Altgeräte“)<sup>1</sup>

## Getrennte Erfassung von Altgeräten

Altgeräte gehören nicht in den Hausmüll, sondern sollten bei speziellen Sammel- und Rückgabesystemen abgegeben werden.

## Trennung von Batterien und Akkus sowie Lampen

Besitzer von Altgeräten haben Altbatterien und Altalkumulatoren, die nicht vom Altgerät umschlossen sind, sowie Lampen, die zerstörungsfrei aus dem Altgerät entnommen werden können, vor der Abgabe an einer Erfassungsstelle vom Altgerät zerstörungsfrei zu trennen. Dies gilt nicht, soweit Altgeräte einer Vorbereitung zur Wiederverwendung unter Beteiligung eines öffentlich-rechtlichen Entsorgungsträgers zugeführt werden.

## Möglichkeiten der Rückgabe von Altgeräten an bestimmte Vertrieber

Wie im Folgenden näher beschrieben, sind bestimmte Vertrieber zur unentgeltlichen Rücknahme von Altgeräten verpflichtet.

Vertrieber mit einer Verkaufsfläche für Elektro- und Elektronikgeräte von mindestens 400 m<sup>2</sup> sowie Vertrieber von Lebensmitteln mit einer Gesamtverkaufsfläche von mindestens 800 m<sup>2</sup>, die mehrmals im Kalenderjahr oder dauerhaft Elektro- und Elektronikgeräte anbieten und auf dem Markt bereitstellen, sind verpflichtet,

- bei der Abgabe eines neuen Elektro- oder Elektronikgeräts an einen Endnutzer ein Altgerät des Endnutzers der gleichen Geräteart, das im Wesentlichen die gleichen

Funktionen wie das neue Gerät erfüllt, am Ort der Abgabe oder in unmittelbarer Nähe hierzu unentgeltlich zurückzunehmen; Ort der Abgabe ist auch der private Haushalt, sofern dort durch Auslieferung die Abgabe erfolgt: In diesem Fall ist die Abholung des Altgeräts für den Endnutzer unentgeltlich; und

- auf Verlangen des Endnutzers Altgeräte, die in keiner äußeren Abmessung größer als 25 cm sind, im Einzelhandelsgeschäft oder in unmittelbarer Nähe hierzu unentgeltlich zurückzunehmen; die Rücknahme darf nicht an den Kauf eines Elektro- oder Elektronikgeräts geknüpft werden und ist auf drei Altgeräte pro Geräteart beschränkt.

Der Vertrieber hat beim Abschluss des Kaufvertrags für das neue Elektro- oder Elektronikgerät den Endnutzer über die Möglichkeit zur unentgeltlichen Rückgabe bzw. Abholung des Altgeräts zu informieren und den Endnutzer nach seiner Absicht zu befragen, ob bei der Auslieferung des neuen Geräts ein Altgerät zurückgegeben wird.

Dies gilt auch bei Vertrieb unter Verwendung von Fernkommunikationsmitteln, wenn die Lager- und Versandflächen für Elektro- und Elektronikgeräte mindestens 400 m<sup>2</sup> betragen oder die gesamten Lager- und Versandflächen mindestens 800 m<sup>2</sup> betragen wobei die unentgeltliche Abholung auf Elektro- und Elektronikgeräte der Kategorien 1 (Wärmeüber-

<sup>1</sup> Nur gültig für Deutschland

träger), 2 (Bildschirmgeräte) und 4 (Großgeräte mit mindestens einer äußeren Abmessung über 50 cm) beschränkt ist. Für alle übrigen Elektro- und Elektronikgeräte muss der Vertrieber geeignete Rückgabemöglichkeiten in zumutbarer Entfernung zum jeweiligen Endnutzer gewährleisten; das gilt auch für Altgeräte, die in keiner äußeren Abmessung größer als 25 cm sind, die der Endnutzer zurückgeben will, ohne ein neues Gerät zu kaufen.

### Löschung von Daten

Der Endnutzer ist für das Löschen der eventuell gespeicherten, personenbezogenen Daten auf den zu entsorgenden Altgeräten selbst verantwortlich.

### Bedeutung des Symbols „durchgestrichene Mülltonne“

Auf Elektro- und Elektronikgeräten befindet sich meist das Symbol einer durchgestrichenen Mülltonne. Das Symbol weist darauf hin, dass das jeweilige Gerät am Ende seiner Lebensdauer getrennt vom Hausmüll zu erfassen ist.

