

# MAGNUS LUX 3DL

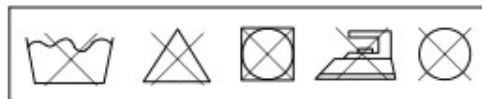

D – Montageanleitung GB – Assembly instructions NL – Handleiding voor de montage PL – Instrukcja montażu TR – Montaj talimatı  
RO – Instrucțiuni de montaj IT – Istruzioni di montaggio FR – Notice de montage SK – Navod na montáž CZ – Montážní návod  
HU – Szerelési útmutató RU – Инструкция по монтажу

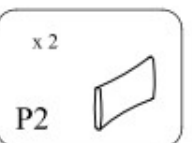
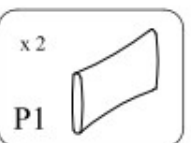
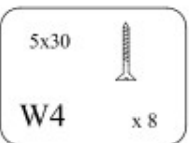
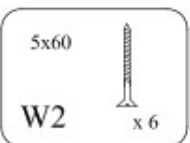
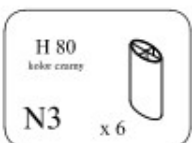

**1**

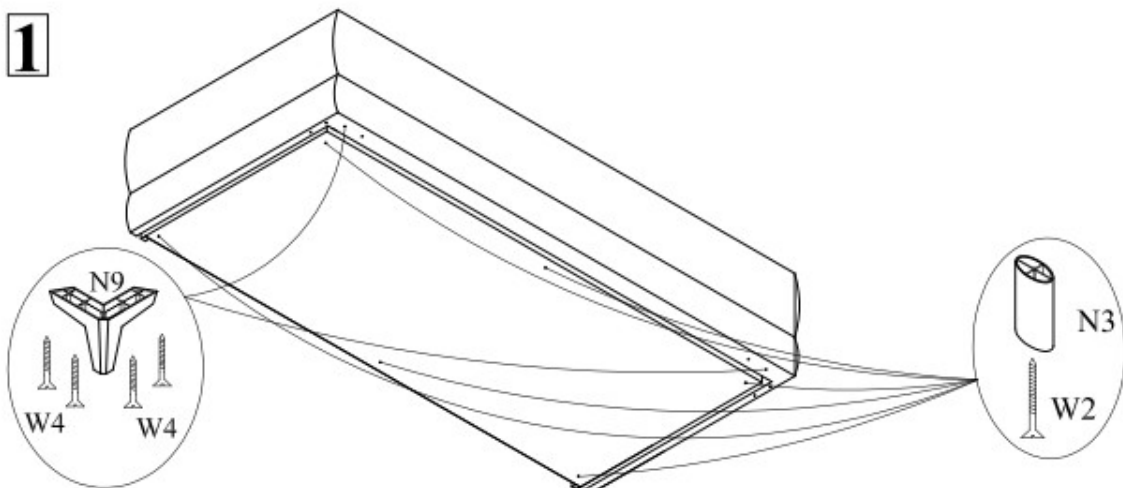

**2**

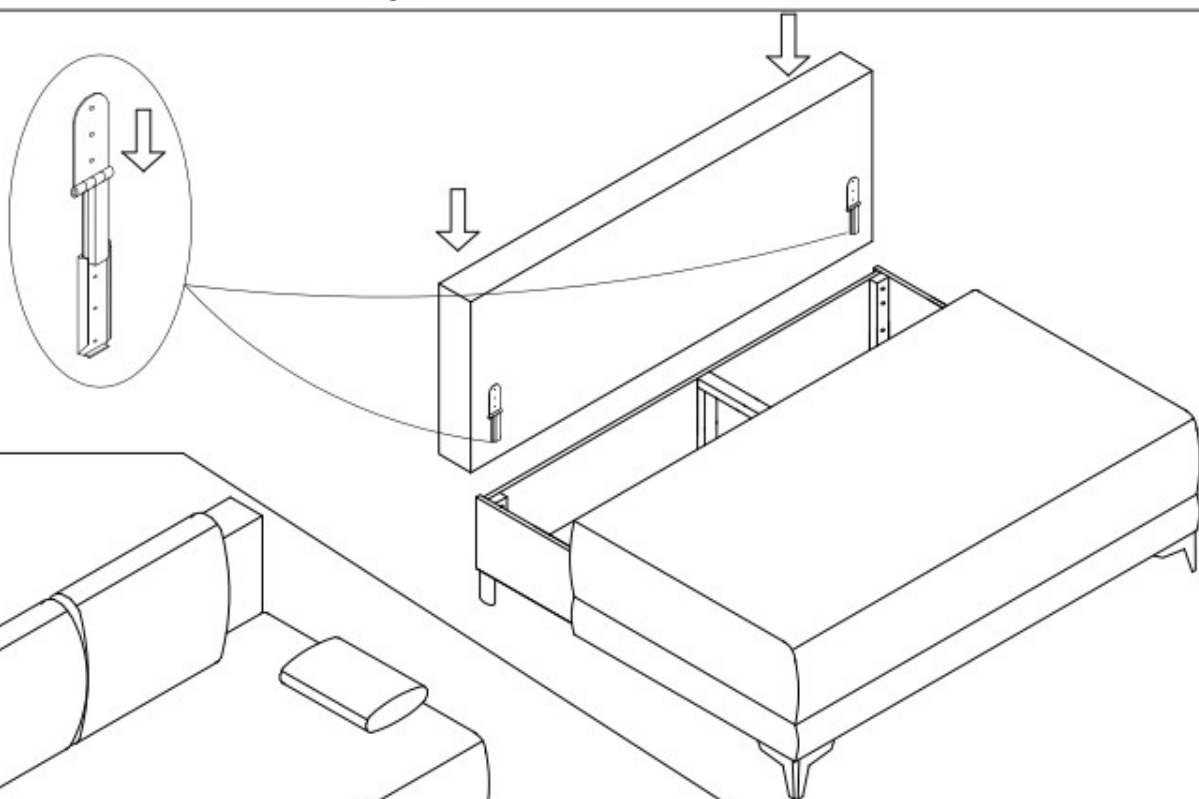

**3**

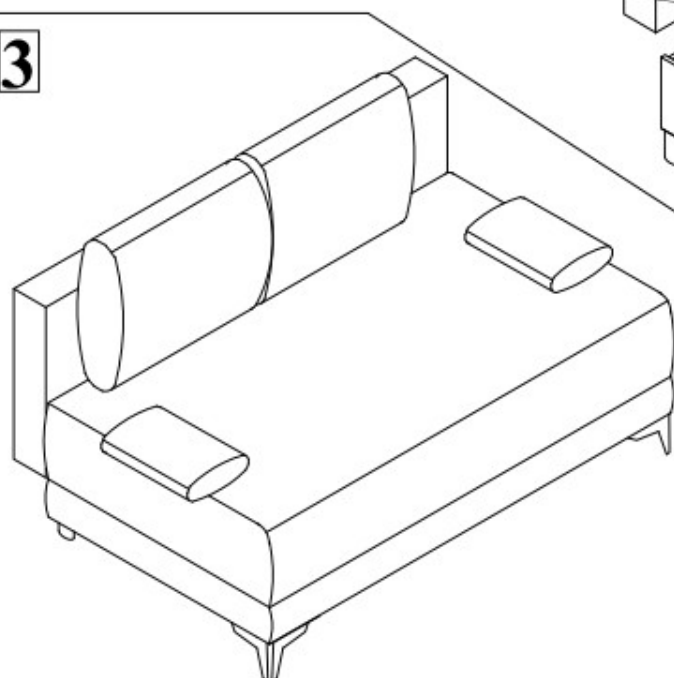

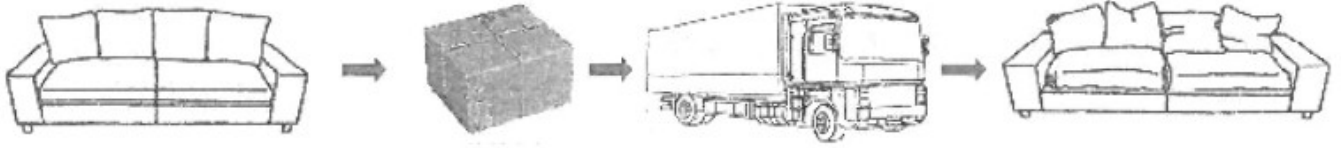

1

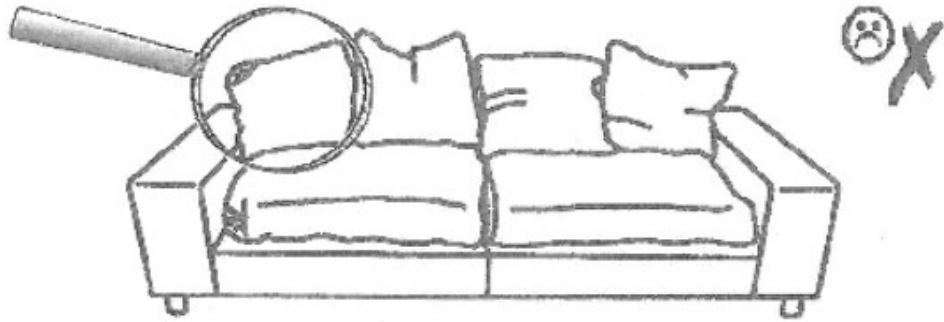

2

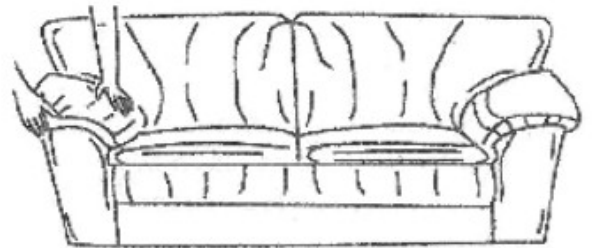
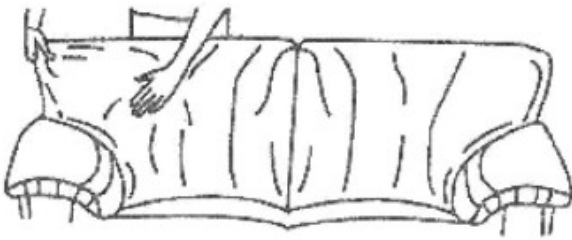
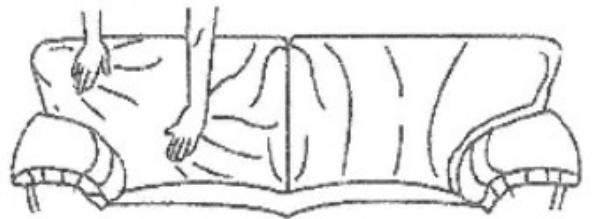
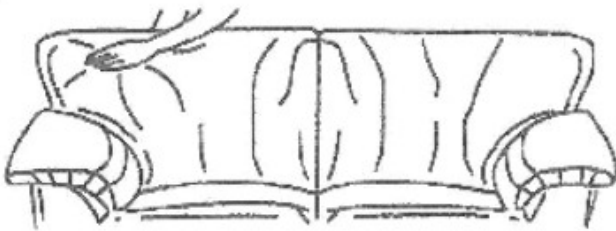

3

