

P292, P293, P301

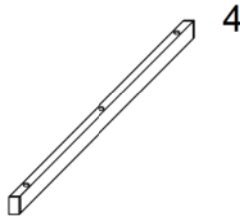

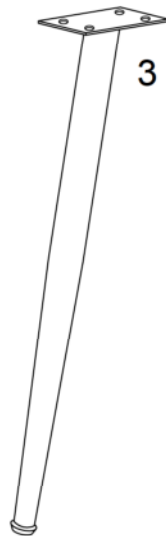

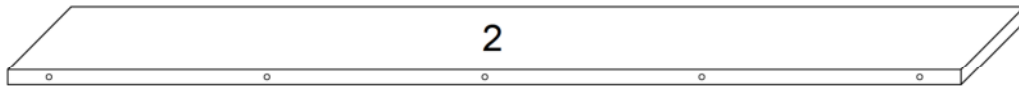
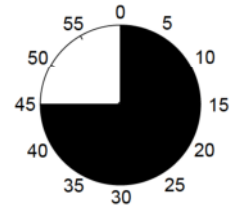
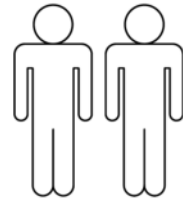
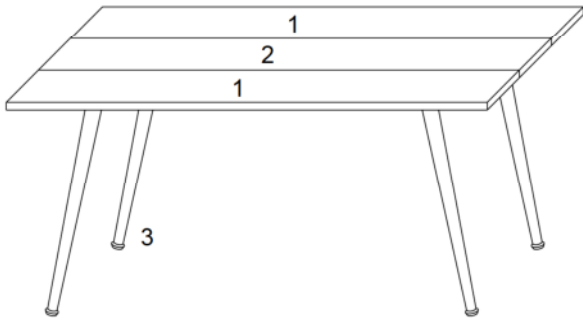

1	2x	1/2
2	1x	1/2
3	4x	2/2
4	2x	2/2

A	M6x35 6x	B	M8x16 16x	C	D18*D8*1.5mm 16x	D	M8x12 16x	E	M6x12 6x	F	SW 5 1x
G	SW 6 1x	H	SW 8 1x	J	8x30 10x	K	 2x				

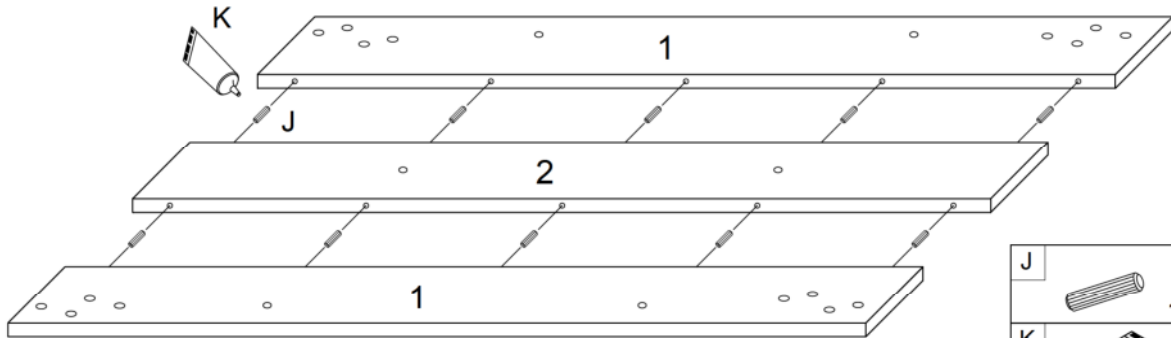
I.

1.



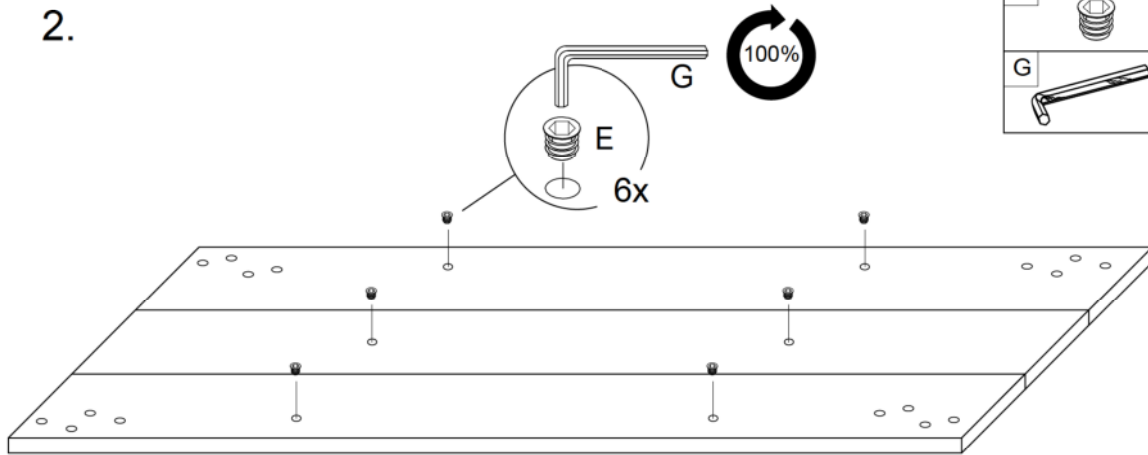

J	8x30
	10x
K	
	1x
E	M6x12
	6x
G	SW6
	1x

2.

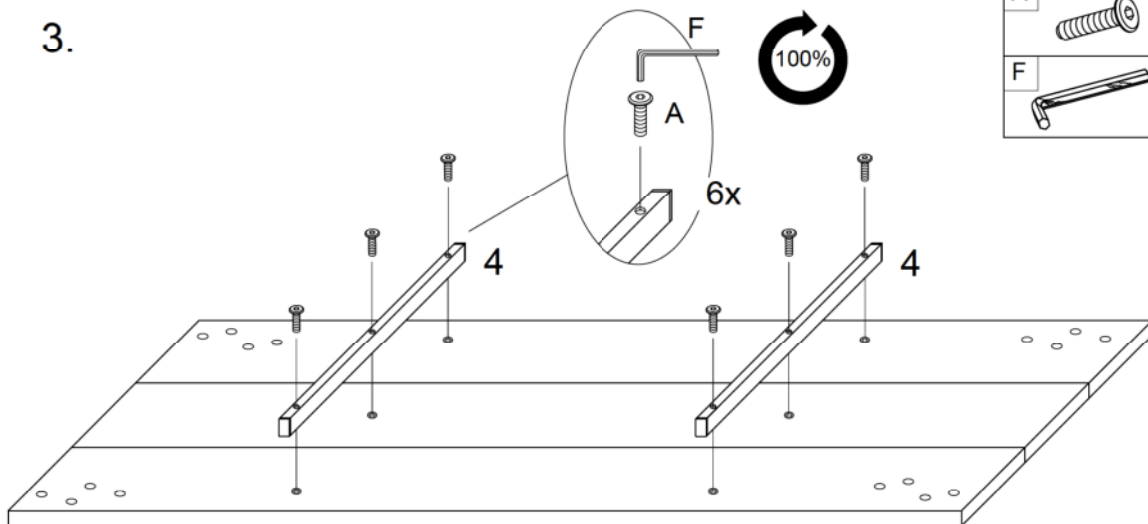

3.



A	M6x35
	6x
F	SW5
	1x

II.

4.

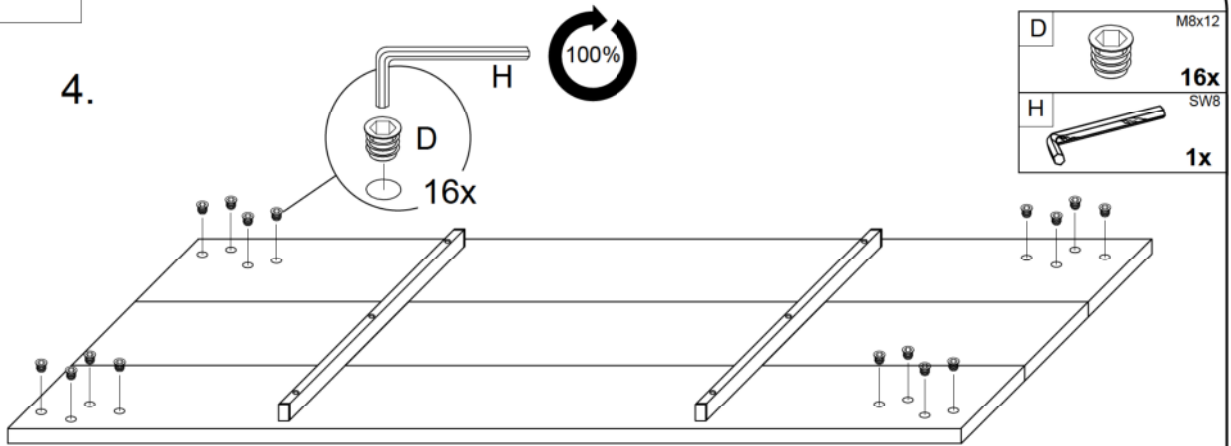

5.

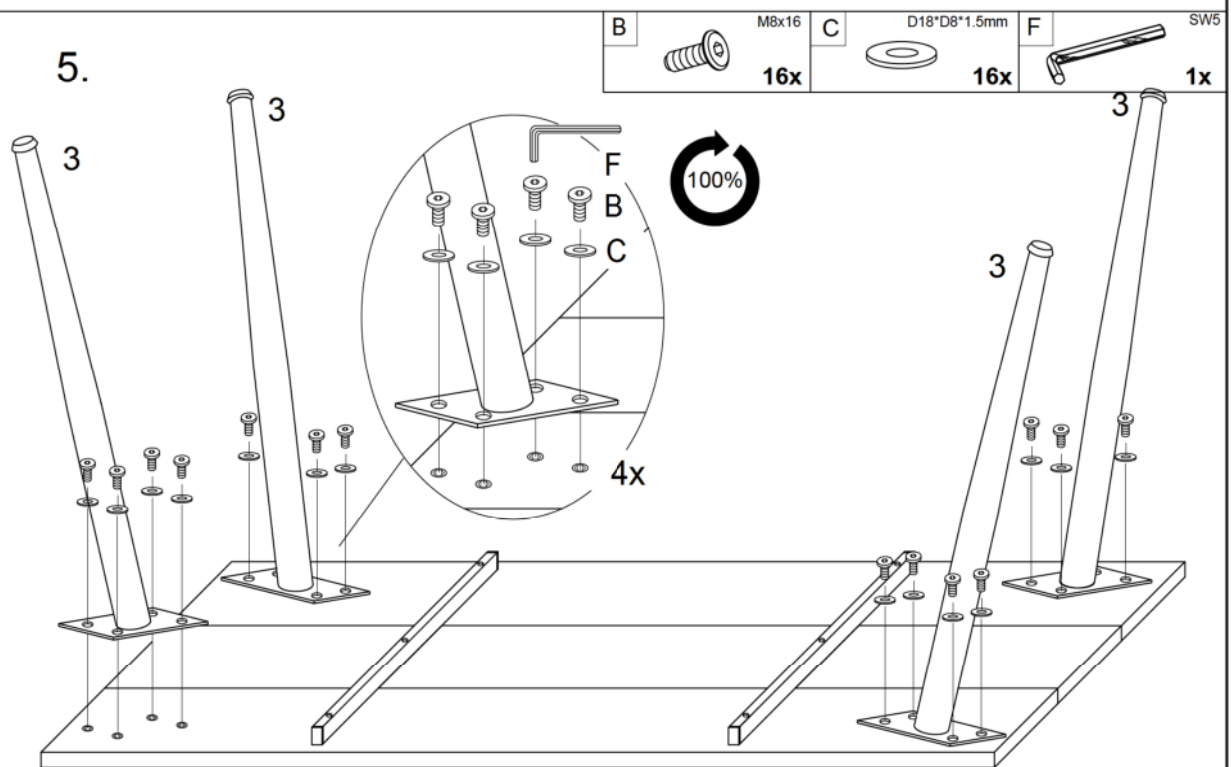

6.

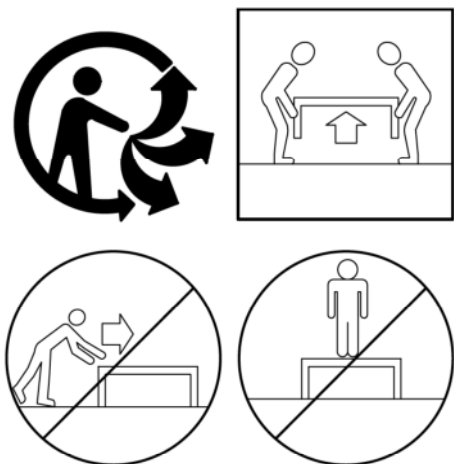
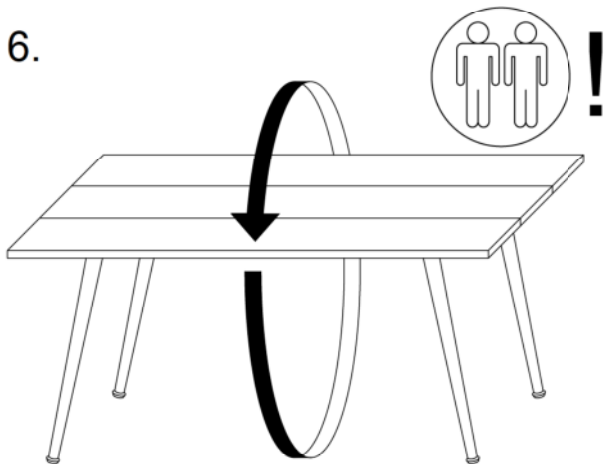

CAROLINE

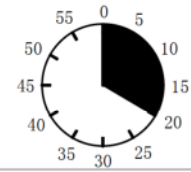
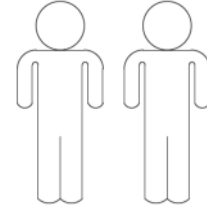
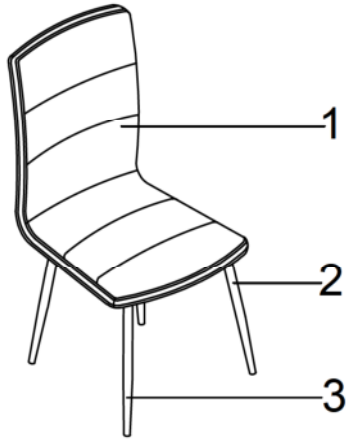

1

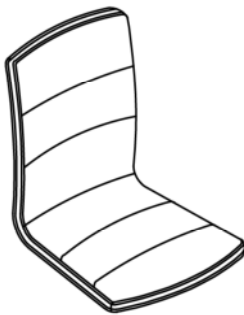



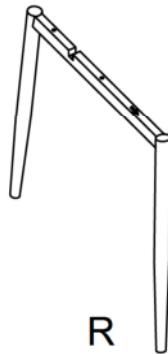

2

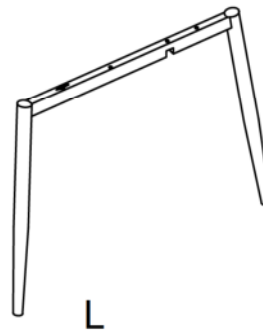

3



1	1X
2	1X
3	1X

 1/1				
A  M6*30 1X	B  M6*45 4X	C  Ø18*Ø6.5*1.5 5X	D  4mm 1X	

I.
1.

B M6*45
2X

C Ø18*Ø6.5*1.5
2X

D 4mm
1X

75%

2.

B M6*45
2X

C Ø18*Ø6.5*1.5
2X

D 4mm
1X

75%

3.

A M6*30
1X

C Ø18*Ø6.5*1.5
1X

D 4mm
1X

75%

4.

D 4mm
1X

100%

LE TRI + FACILE **BAC DE TRI**

Séparez les éléments avant de trier