

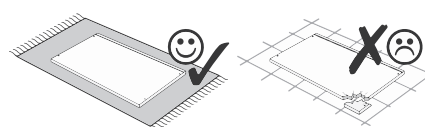

88155.330

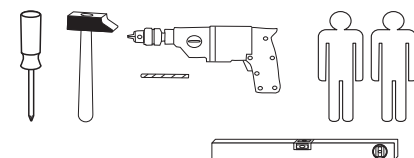

1 8 x 2802	2 8 x 2801	3 3,5 x 15 2 x 2804	4 8 x 30 8 x 2861
5 4 x 30 4 x 2812	6 5,8 x 55 2 x 2840	7 8 x 30 2 x 2842	8 2 x 2843.1
9 5/5 x 16 16 x 2821	10 4 x 27 2 x 2829	11 Leim 1 x 2863	12 25 x 2862
13 4 x 9 4 x	14 5 x 30 2 x 4 x 2552		

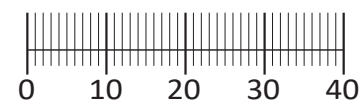

Das beigefügte Wandbefestigungsmaterial (Dübel und Schrauben) eignet sich nur für festes Mauerwerk (z.B.: Beton- oder Ziegelwände). Für andere Wandaufbauten sind eventuell Spezialdübel und andere Schrauben notwendig. Ziehen Sie gegebenenfalls eine Fachkraft zu Rate.

De begeleidende wandmontage hardware (pluggen en schroeven) is alleen geschikt voor massief metselwerk (bijvoorbeeld beton of bakstenen muren). Voor andere muur structuren zijn eventueel bijzondere ankerbouten en andere noodzakelijke. Draai indien nodig, een deskundige.

Приложенный материал для крепления к стене (дюбели и винты) пригоден только для жестких кладок (например, бетонные или кирпичные стены). Для других настенных конструкций необходимы смотря по обстоятельствам специальные дюбели и другие винты. При необходимости проконсультируйтесь у специалиста.

Le mur d'accompagnement matériel de montage (chevilles et les vis) ne convient que pour la maçonnerie solide (par exemple en béton ou des murs de briques). Pour les structures de mur d'autres sont peut-être spéciale boulons d'ancrage et d'autres nécessaires. Serrer le cas échéant, un expert.

Zalączony materiał do mocowania do ściany (kolki rozprężne i wkręty) nadaje się tylko do ścian murowanych (np. z betonu lub cegiel). Do ścian wykonanych w innych technologiach konieczne być mogą specjalne kolki rozprężne i inne wkręty. W razie potrzeby skorzystaj z fachowej pomocy

Il muro di accompagnamento hardware di montaggio (tasselli e viti) è'e adatto solo per muratura piena (ad esempio calcestruzzo o muratura). Per le altre strutture murarie sono forse speciali bulloni di ancoraggio e necessari di altri. Serrare se necessario, un esperto.

The accompanying wall mounting hardware (anchors and screws) is suitable only for solid masonry (eg concrete or brick walls). For other wall structures are possibly special anchor bolts and other necessary. Tighten if necessary, an expert.

Ekteki duvara sabit montaj malzemeleri (dübel ve vidalar), sadece sağlam duvarlar için (örnek: beton veya tuğla) elverişlidir. Başka duvarlar için özel dübeller ve farklı vidalar gerekebilir. Gerekliğinde bir uzmana danışınız.

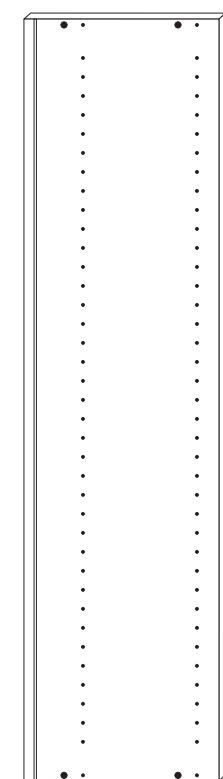

16 2 x

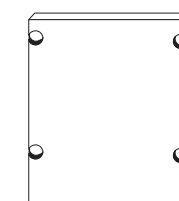

17 2 x

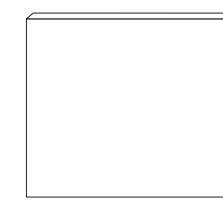

19 1 x

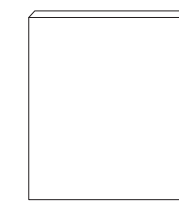

18 4 x

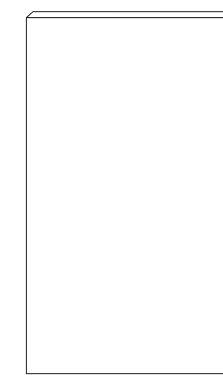

20 1 x



21 1 x

1

1 8 x 2802	5 4 x 30 4 x 2812	8 2 x 2843.1	9 5/5 x 16 16 x 2821
----------------------	--------------------------------	------------------------	-----------------------------------

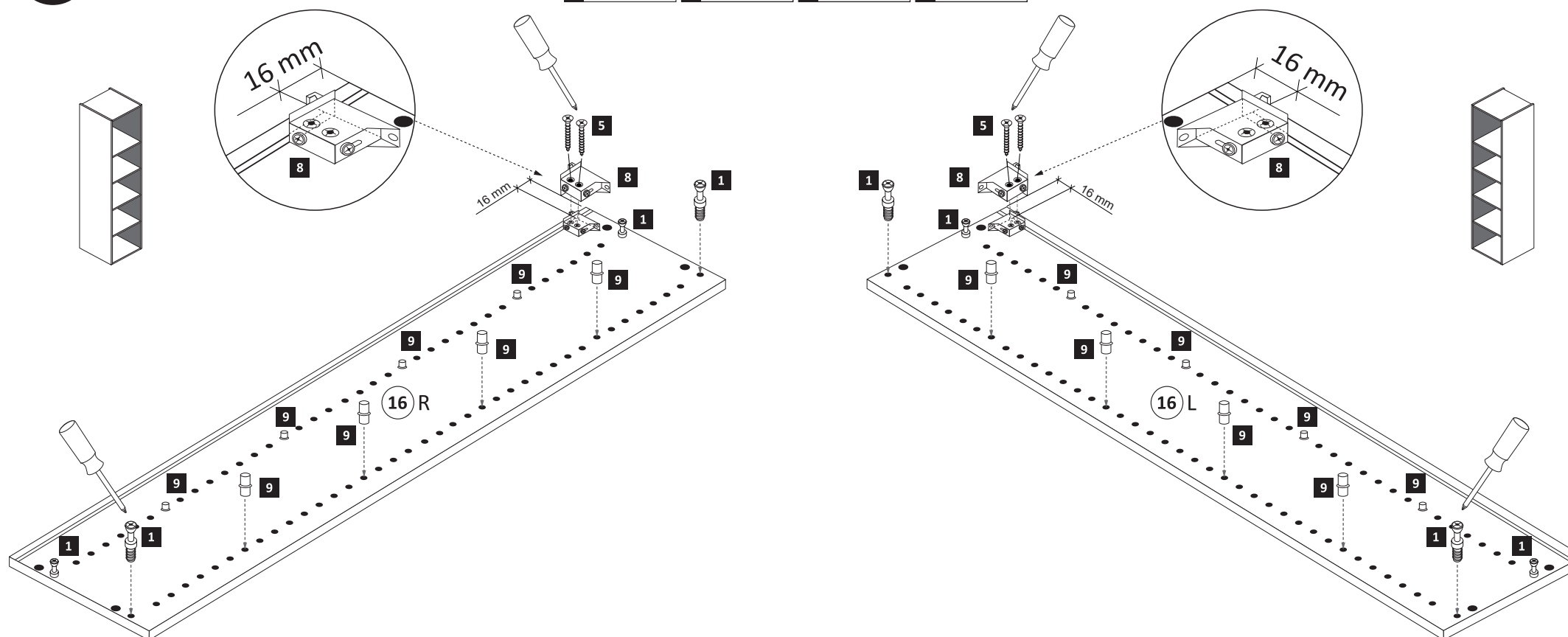

2

2 8 x 2801	4 8 x 30 8 x 2861	11 Leim 1 x 2863
----------------------	--------------------------------	-------------------------------

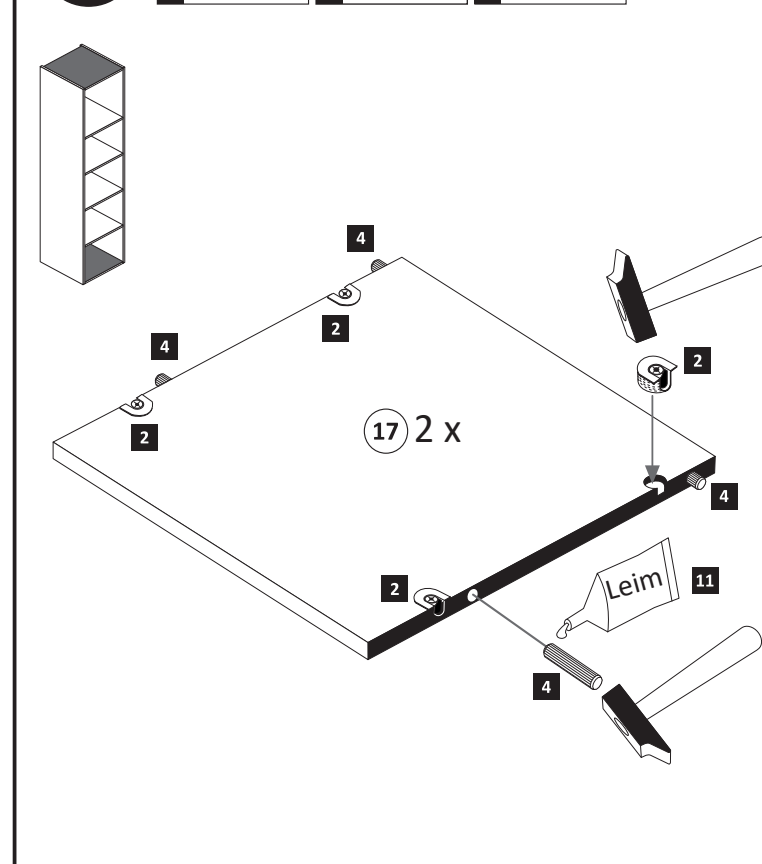

3

3,5 x 15
2 x
2804

11
Leim

17

16 R

16 L

17

8

3

11
1 x
2863

20 min.

D Leim
GB Glue
NL Lijm
PL Klej
TR Tutkal
F Colle
I Colla

4

12
25 x
2862

14
4 x
2552

1. 21

2. 21

3. 21

12

14

21

5

4 x 27
2 x
2829

Variante Einzelschrank

1. 19

2. 19

16 L

16 R

10

10

3.

1. 19

Ø 5 mm

oben

Variante mit zwei Schränken

1. 13

4 x
4 x

5 x 30
2 x

2. 20

3. 13

1. 13

2. 13

3. 13

4. 20

Ø 5 mm

5. 20

16 L

16 R

10

10

6.

2. 20

Ø 5 mm
2 x

6

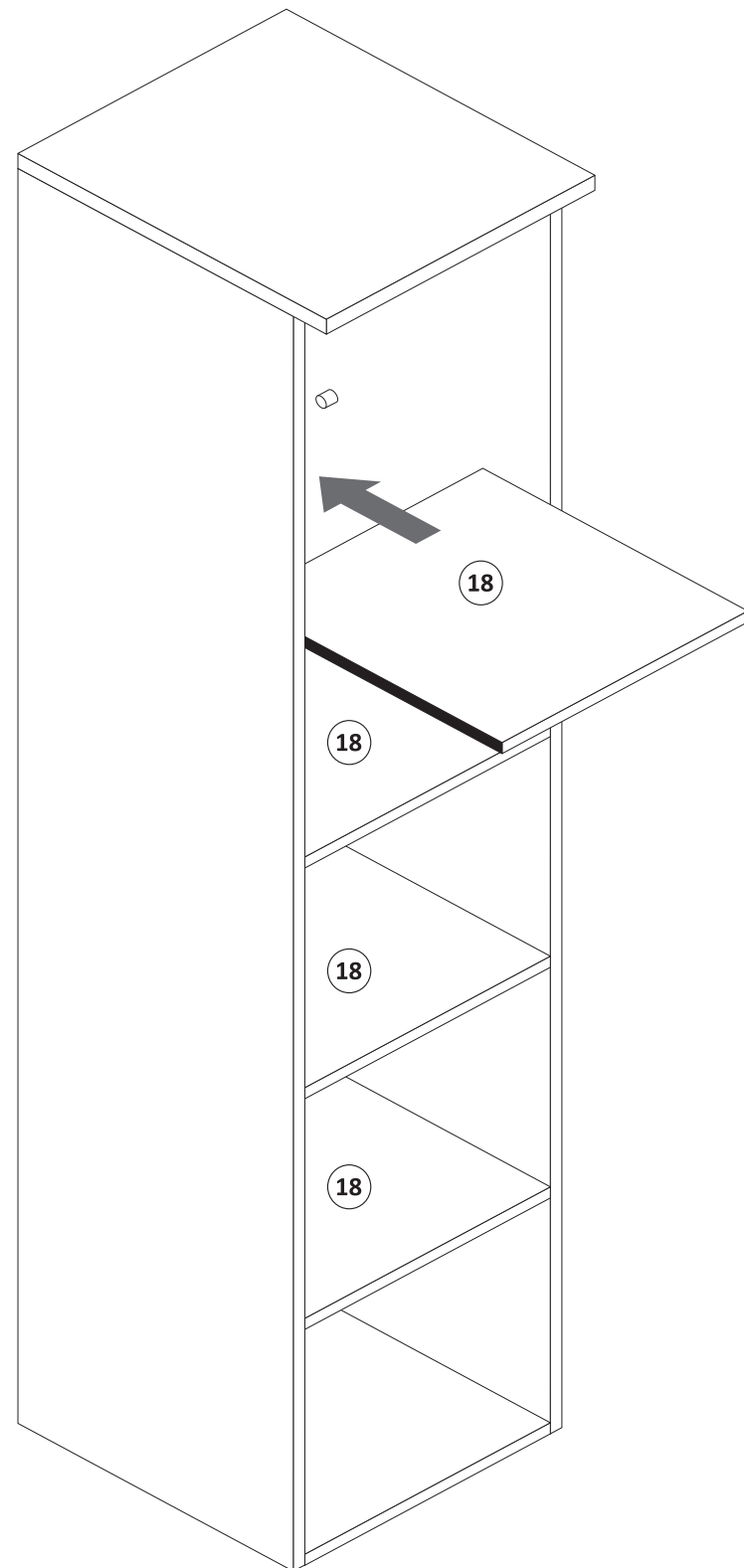
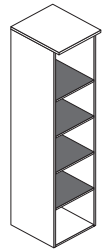

7

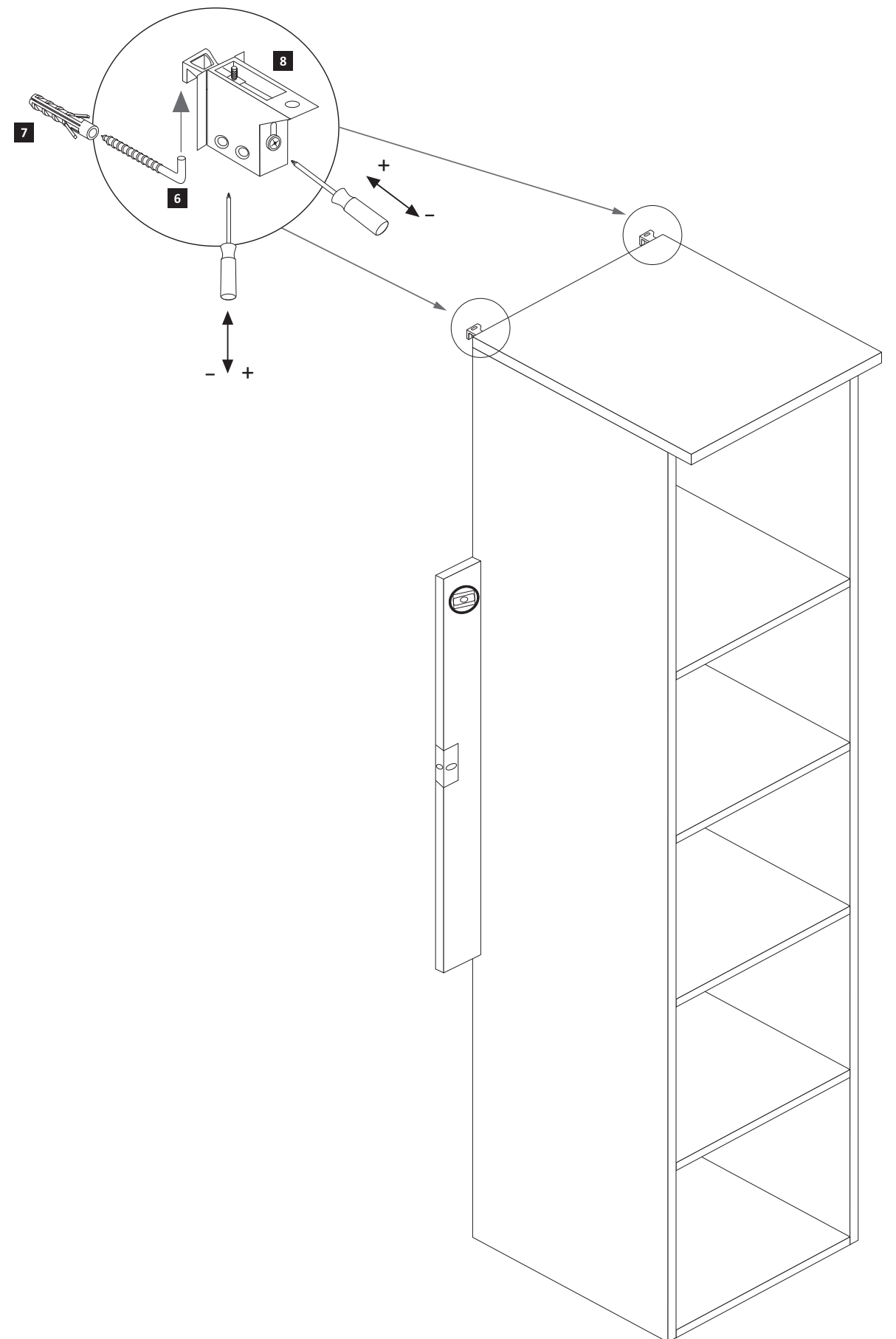
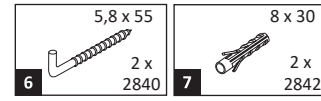



1 4551

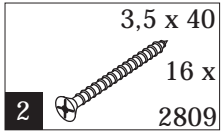

2

