

P292, P293, P301

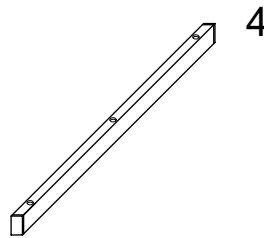
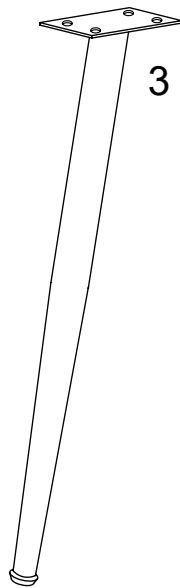
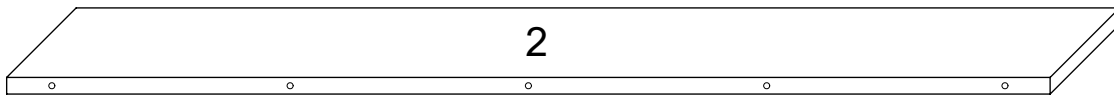
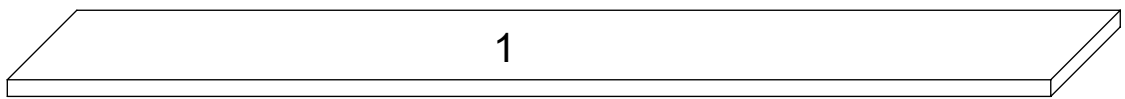
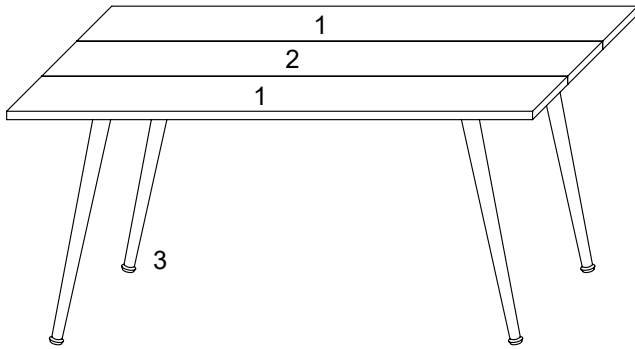
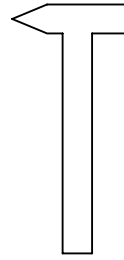
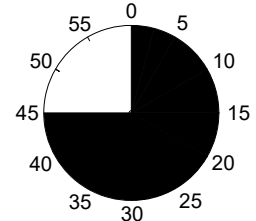
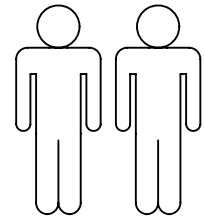

1	2x	1/2
2	1x	1/2
3	4x	2/2
4	2x	2/2

A	M6x35 6x	B	M8x16 16x	C	D18*D8*1.5mm 16x	D	M8x12 16x	E	M6x12 6x	F	SW 5 1x
G	SW 6 1x	H	SW 8 1x	J	8x30 10x	K	2x				

I.

1.

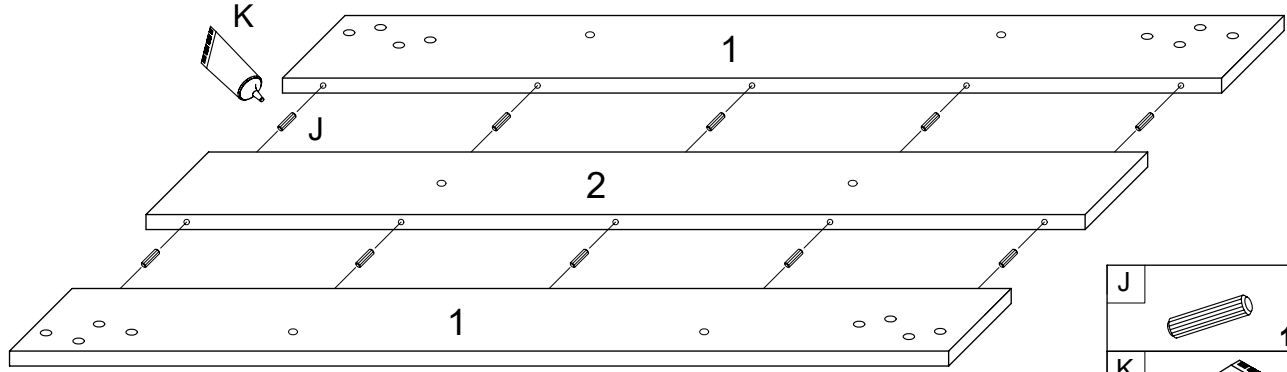

J	8x30	10x
K		1x
E	M6x12	6x
G	SW6	1x

2.

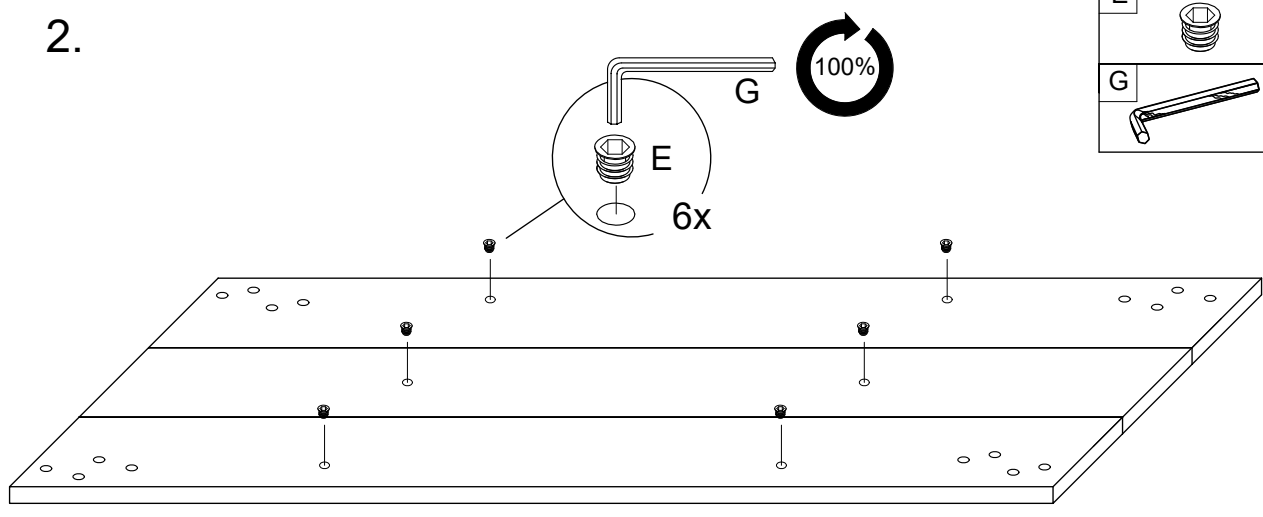

3.

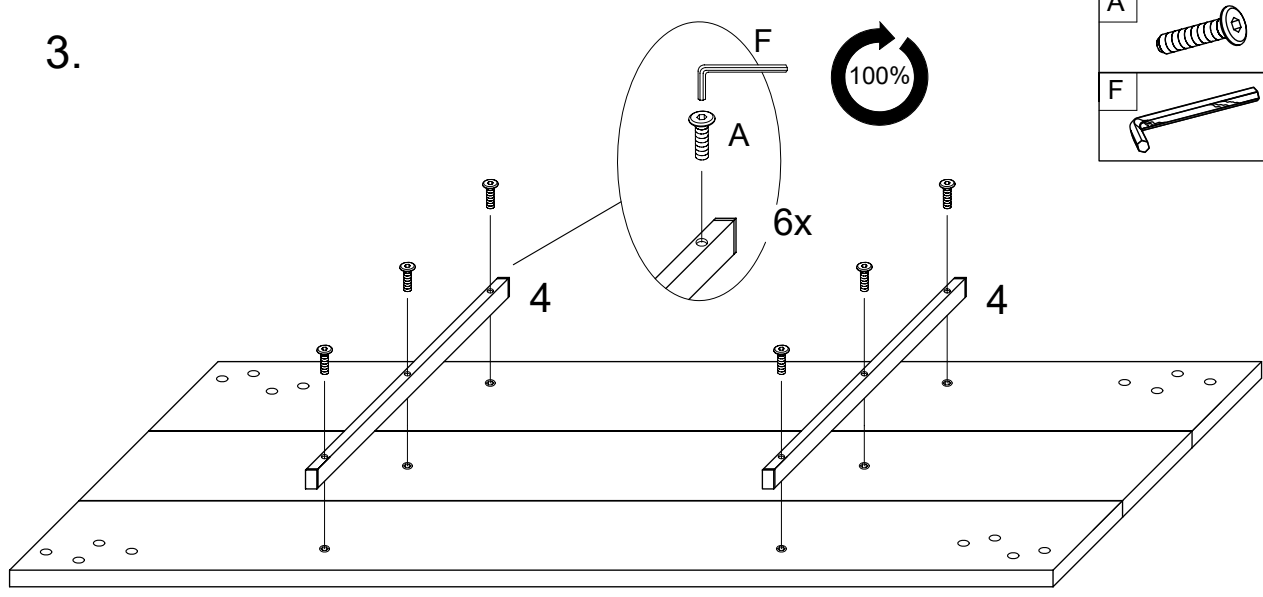

A	M6x35	6x
F	SW5	1x

II.

4.

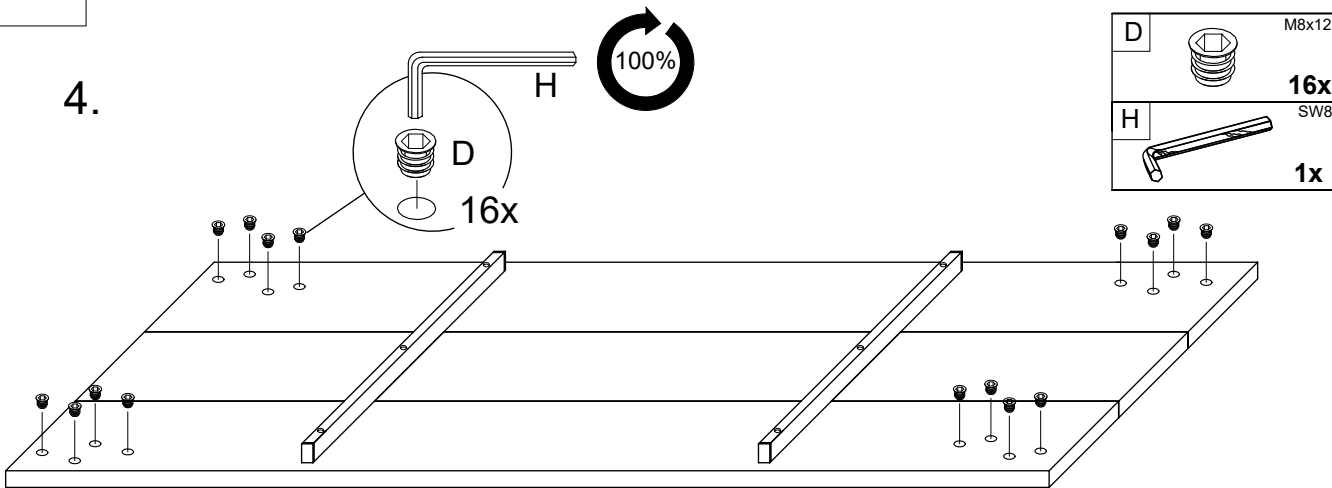

5.

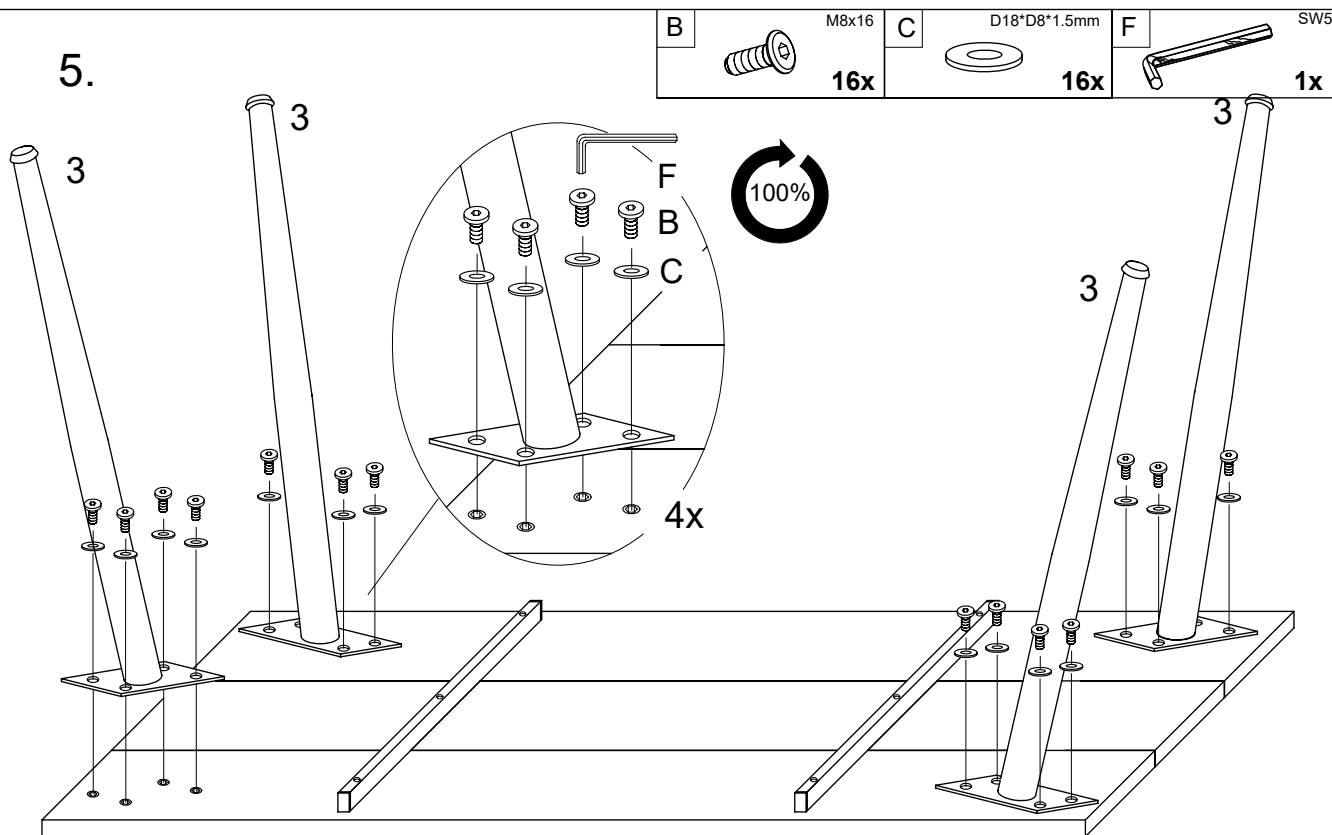

6.

