



(D) Videounterstützte Montageanleitung

(TR) Video destekli kurulum talimatları

(RU) инструкция по монтажу с помощью видеосигнала

(RO) Instrucțiuni de instalare acceptate video

(GB) Video-assisted assembly instructions

(IT) Istruzioni di montaggio video-assistite

(CZ) Instalační pokyny podporované videem

(PL) Instrukcje montażu wspomagane sygnałem wizyjnym

(FR) Instructions de montage assistées par vidéo

(NL) Video-ondersteunde montage-instructies

(HU) Video-támogatott telepítési utasítások

(SK) Inštaláčne pokyny podporované videom

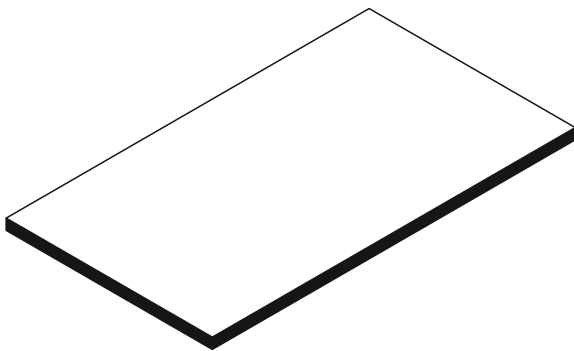
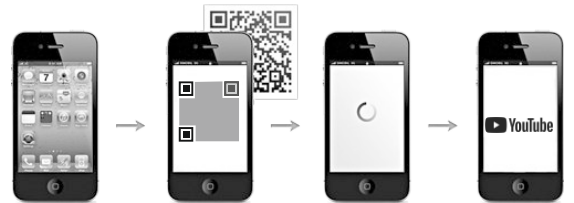

# 0205\_140 Tischplatte

REPC-Nr.:

Service • Assistenza • Dienstverlening • Serwis  
Servis • Szerviz • Сервисная служба

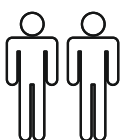
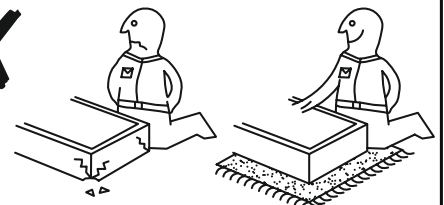
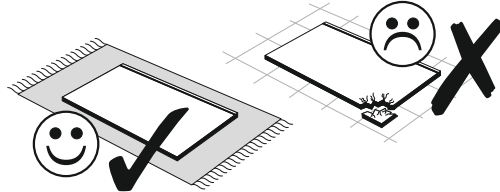
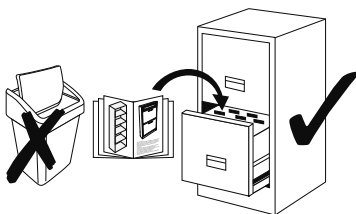
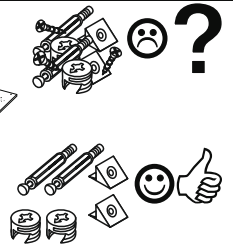
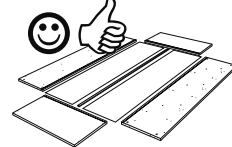
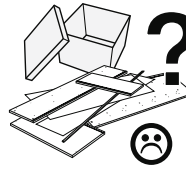
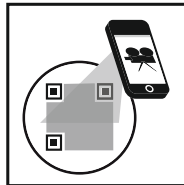
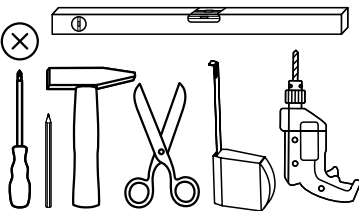

Das Ersatzteil-Anforderungsformular finden Sie auf <https://www.maeusbacher.de/ersatzteile/>

# Colli 1/1

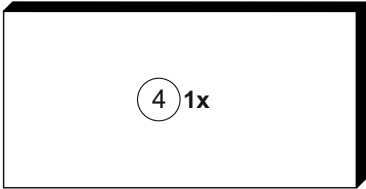

1400 x 700

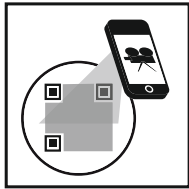



(D) Videounterstützte Montageanleitung

(TR) Video destekli kurulum talimatları

(RU) инструкция по монтажу с помощью видеосигнала

(RO) Instrucțiuni de instalare acceptate video

(GB) Video-assisted assembly instructions

(IT) Istruzioni di montaggio video-assistite

(CZ) Instalační pokyny podporované videem

(PL) Instrukcje montażu wspomagane sygnałem wizyjnym

(FR) Instructions de montage assistées par vidéo

(NL) Video-ondersteunde montage-instructies

(HU) Video-támogatott telepítési utasítások

(SK) Inštaláčn  pokyny podporované videom

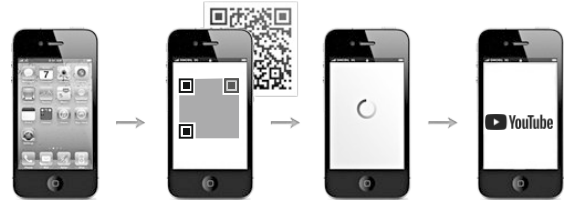
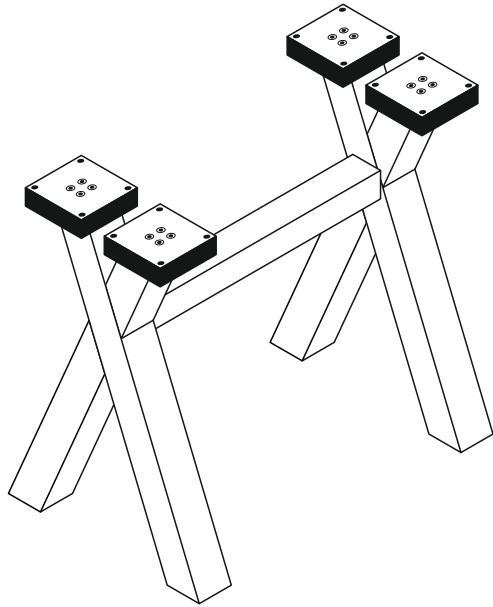

# 0530\_X- P2 Untergestell X

REPC-Nr.:

Service • Assistenza • Dienstverlening • Serwis  
Servis • Szerviz • Сервисная служба

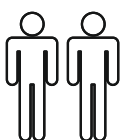
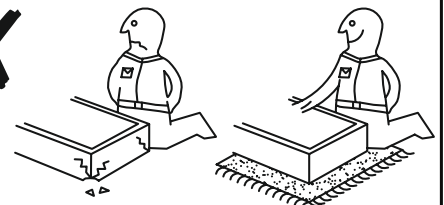
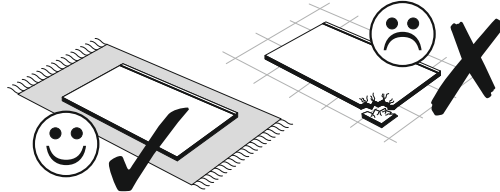
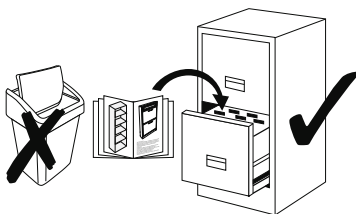
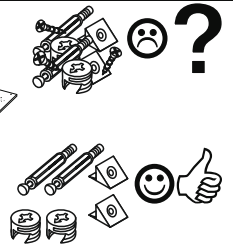
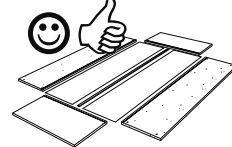
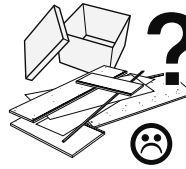
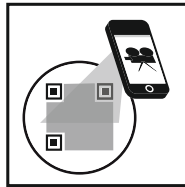
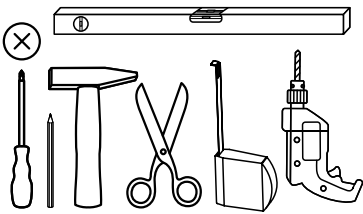

Das Ersatzteil-Anforderungsformular finden Sie auf <https://www.maeusbacher.de/ersatzteile/>

## Beutel 1/2

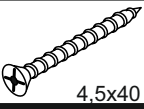
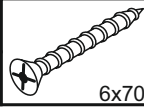
1-172		1-184	
16x	4.5x40	16x	6x70

## Beutel 2/2

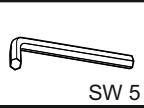
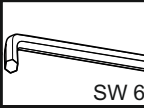
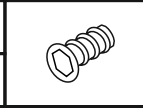
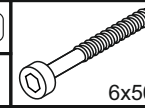
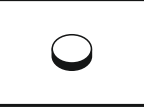
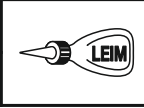
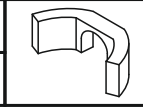
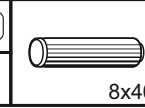
1-241		1-242		1-360		1-362	
1x	SW 5	1x	SW 6	2x		2x	6x50
2-166		5-130		1-364		2-104	
16x		1x	LEIM	2x		10x	8x40

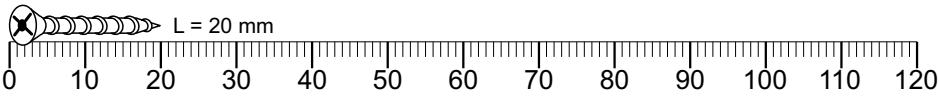
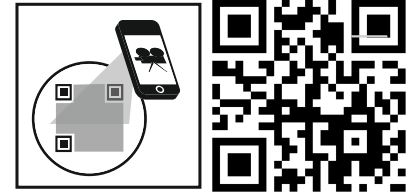

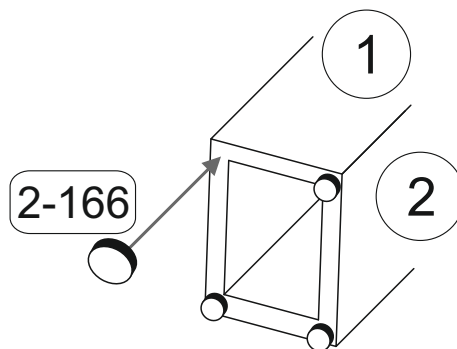
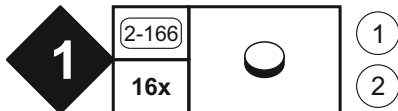
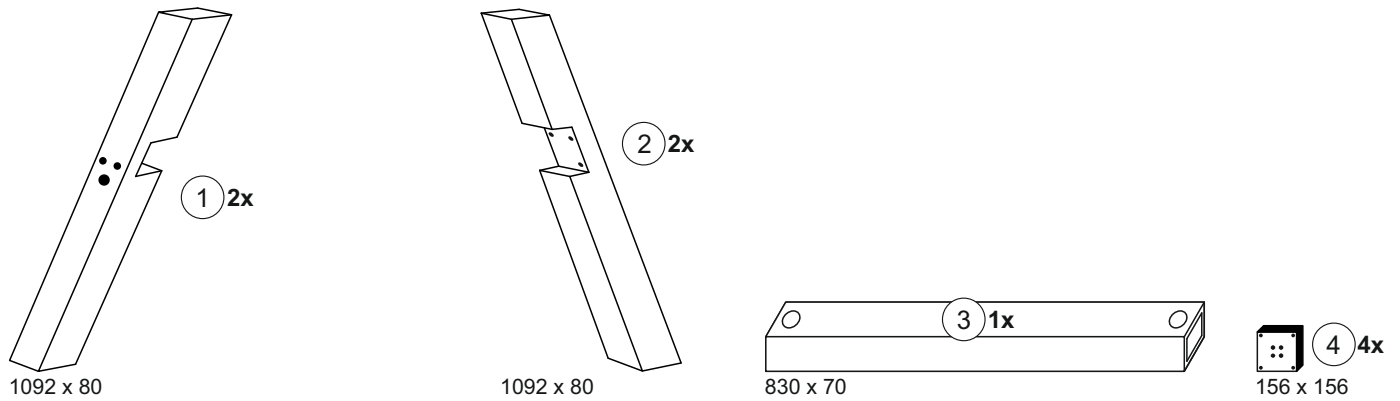

## Colli 1/1

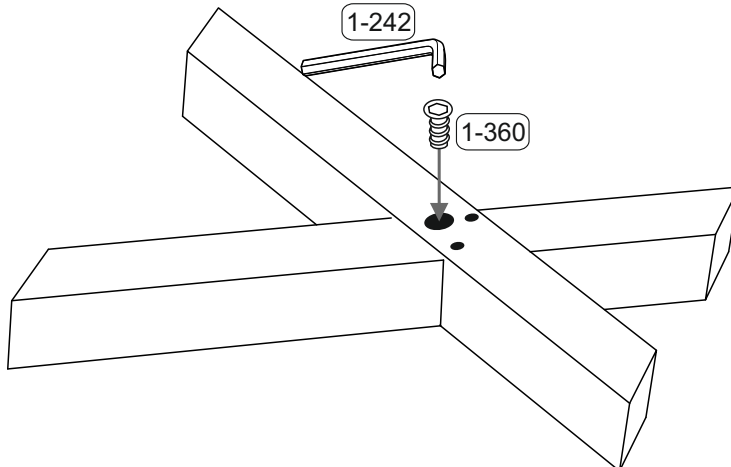
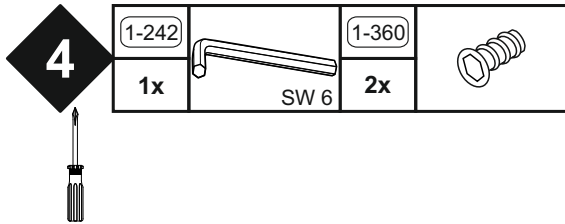
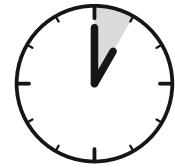
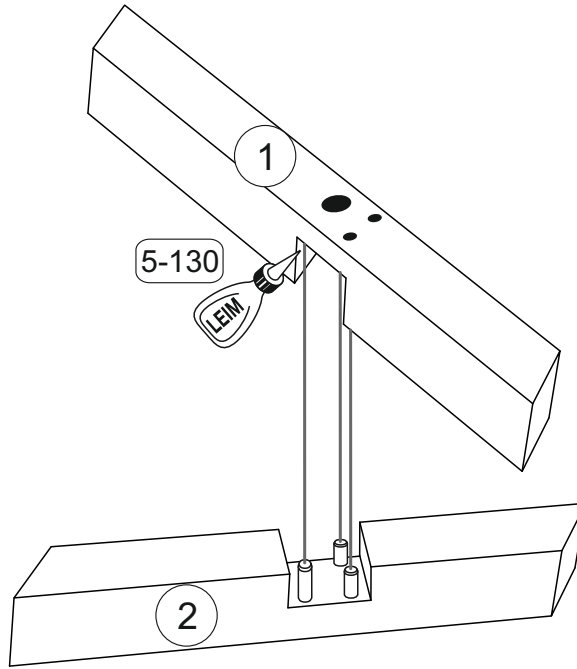
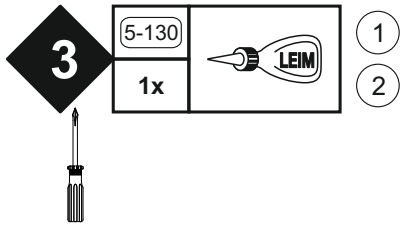
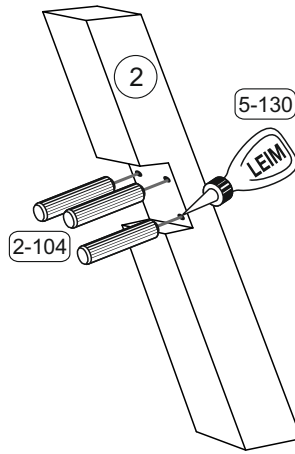
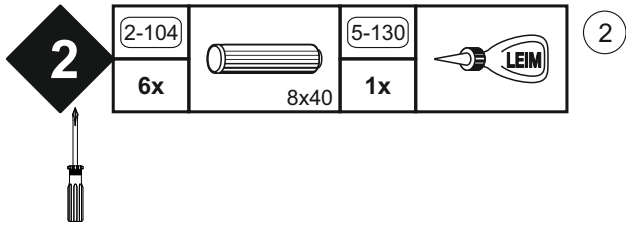

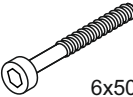

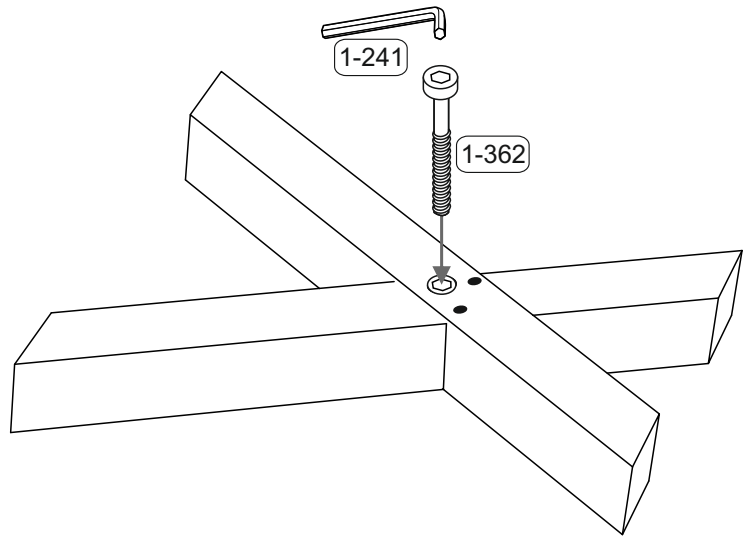
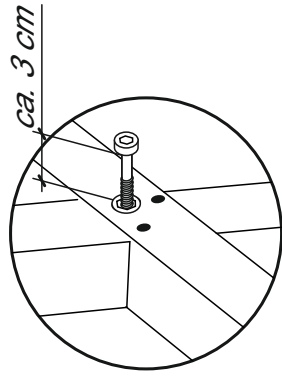

<b>5</b>	1-241		SW 5
	1x		
	1-362		6x50
	2x		

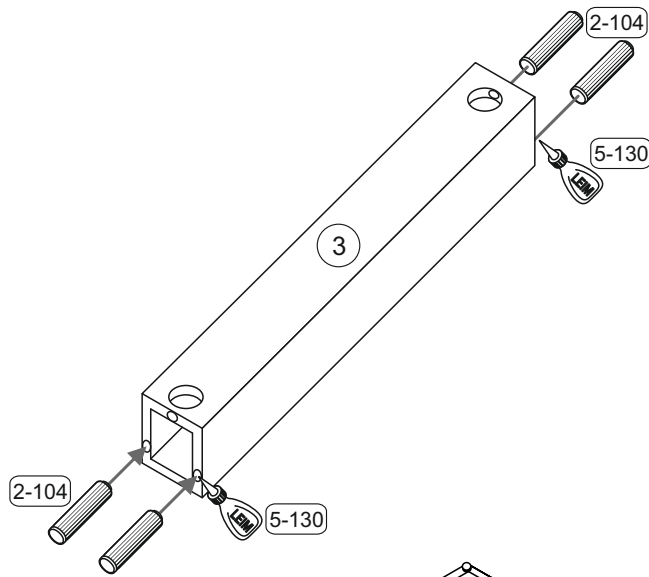

<b>6</b>	2-104		8x40
	4x		
	5-130		LEIM
	1x		

3



<b>7</b>	5-130		LEIM
	1x		

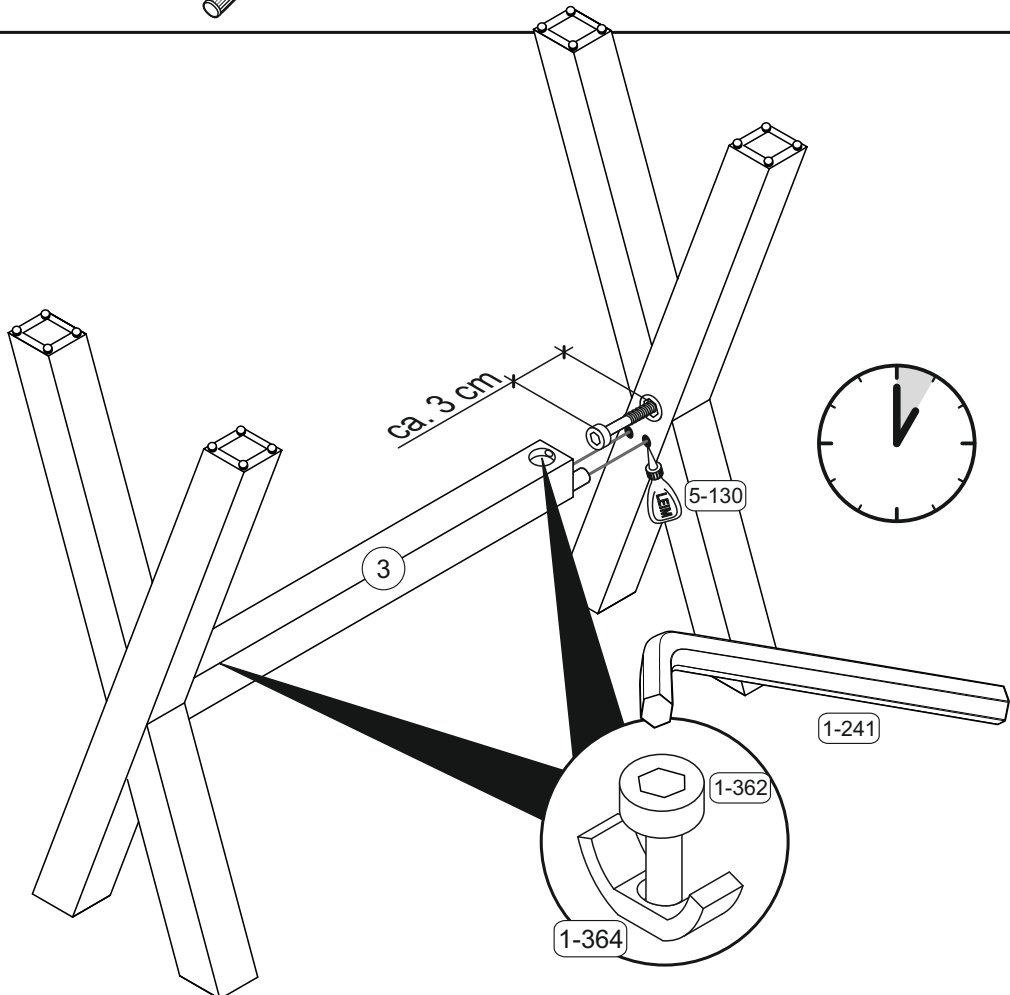

**8**

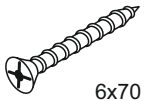
1-184	
16x	6x70

4

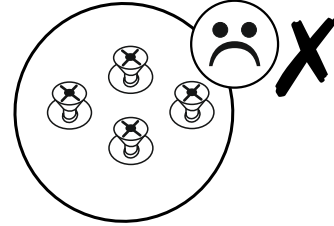
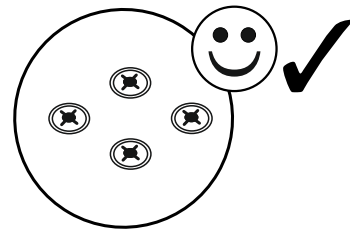
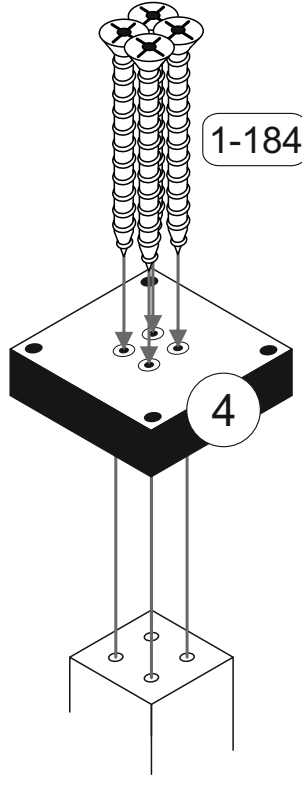
**9**

1-172	
16x	4,5x40

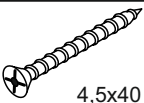