

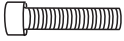
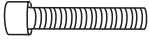

# WF530688

## ASSEMBLY INSTRUCTION

## INSTALLATIONSANLEITUNG

## INSTRUCTIONS D'INSTALLATION

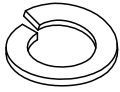
ELEMENTS/PARTS	<p>Ax7</p>  <p>M8x45mm</p>	<p>Bx4</p>  <p>M8x50mm</p>	<p>Cx11</p> 
Dx1	<p>Ex11</p> 		

Bitte beachten Sie, dass die Formen der Schrauben A und B ähnlich sind, Bitte installieren Sie entsprechend der Anleitung und unterscheiden Sie sie!

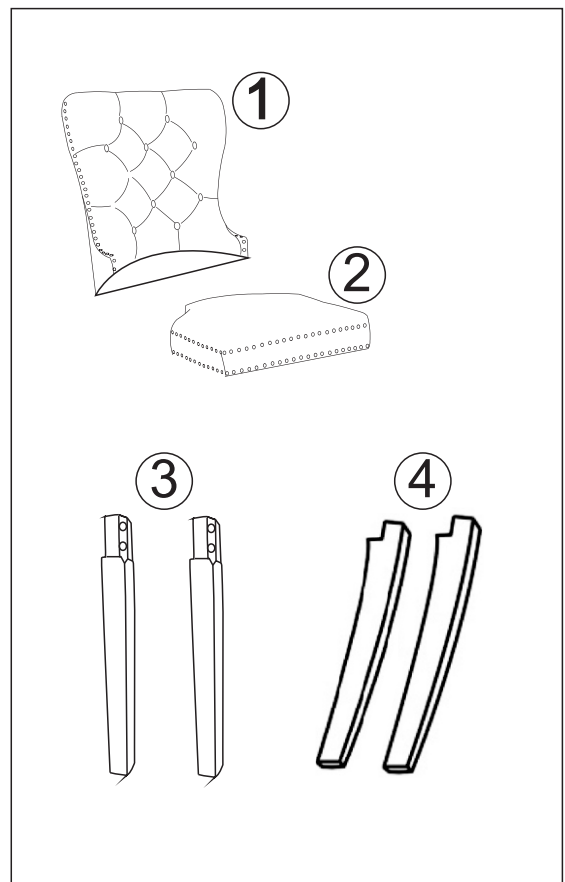
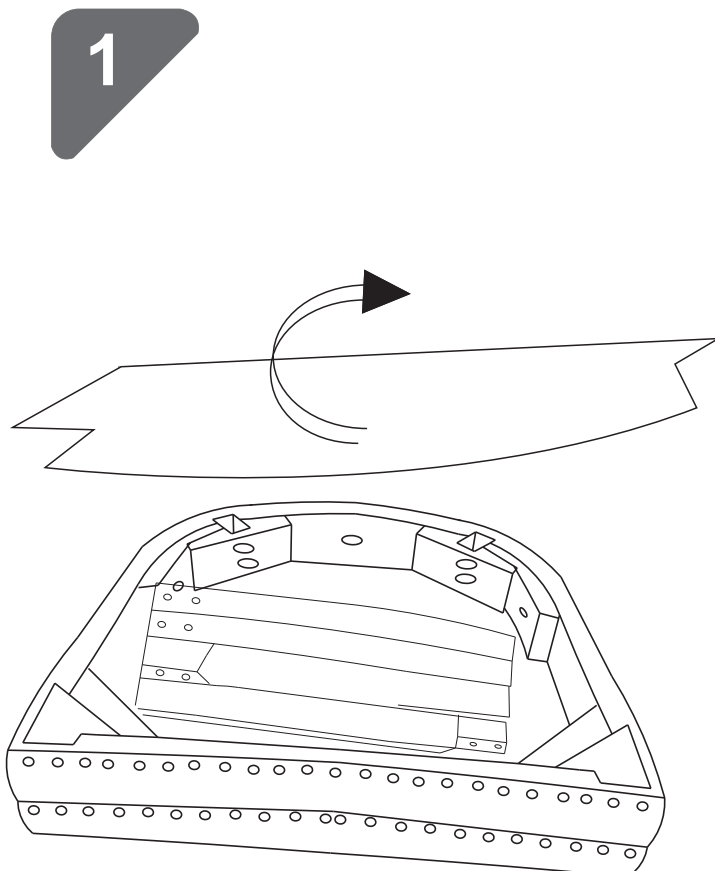

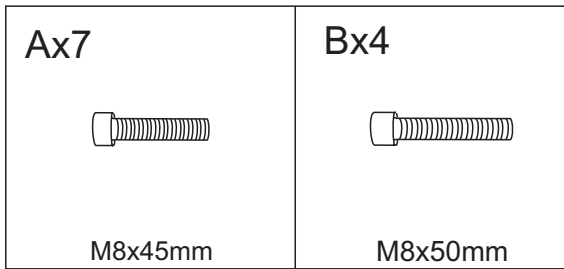

Bitte beachten Sie, dass die Formen der Schrauben A und B ähnlich sind. Bitte installieren Sie entsprechend der Anleitung und unterscheiden Sie sie!

Please note that the shapes of screws A und B are similar. Please install eaccordingto the instructions and distinguish them!

Notez que les vis A und B ont des formes similaires. Veuillez les installer en suivant les instructions pour les séparer!

2

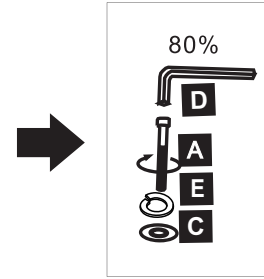
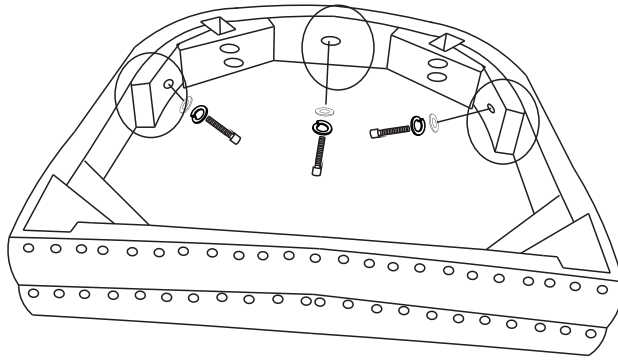



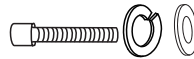

Beachten Sie, dass die Schrauben vertikal in die Lochposition geschraubt werden müssen

The screw needs to be screwed vertically into the hole position

Notez que les vis doivent être vissées verticalement dans le trou



M8x45

<b>A</b>		3PCS M8x45mm
<b>C</b>		3PCS
<b>D</b>		1PCS
<b>E</b>		3PCS

3

M8x50 

M8x45 

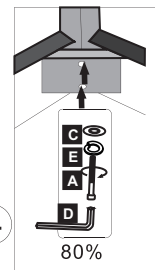
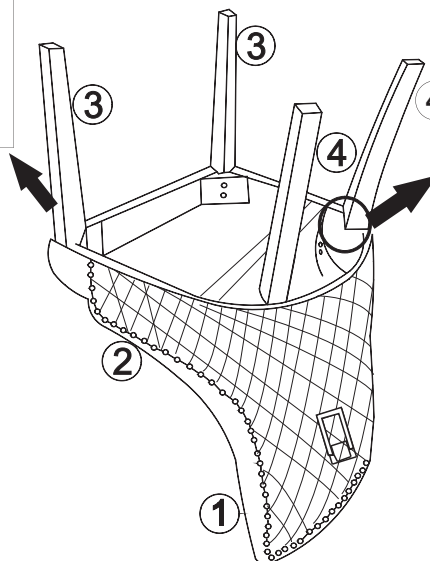
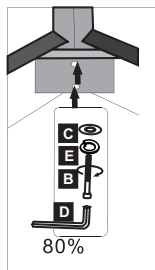
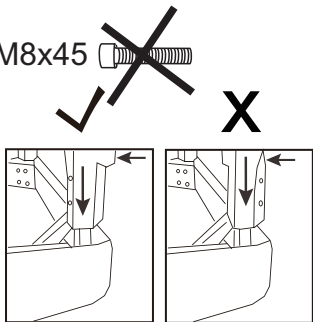



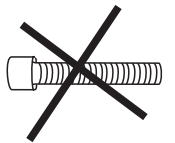

M8x50

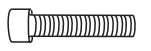

M8x45



<b>A</b>		4PCS M8x45mm
<b>B</b>		4PCS M8x50mm
<b>C</b>		8PCS
<b>D</b>		1PCS
<b>E</b>		8PCS

4

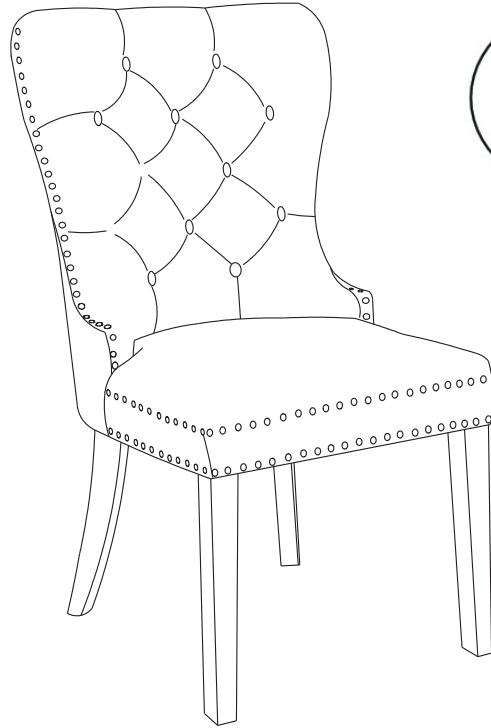
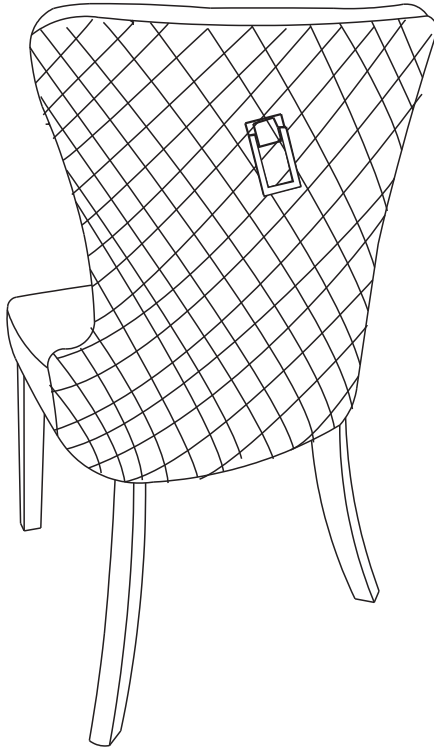

ABC

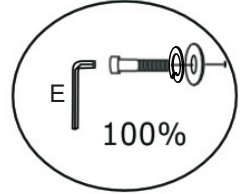

5

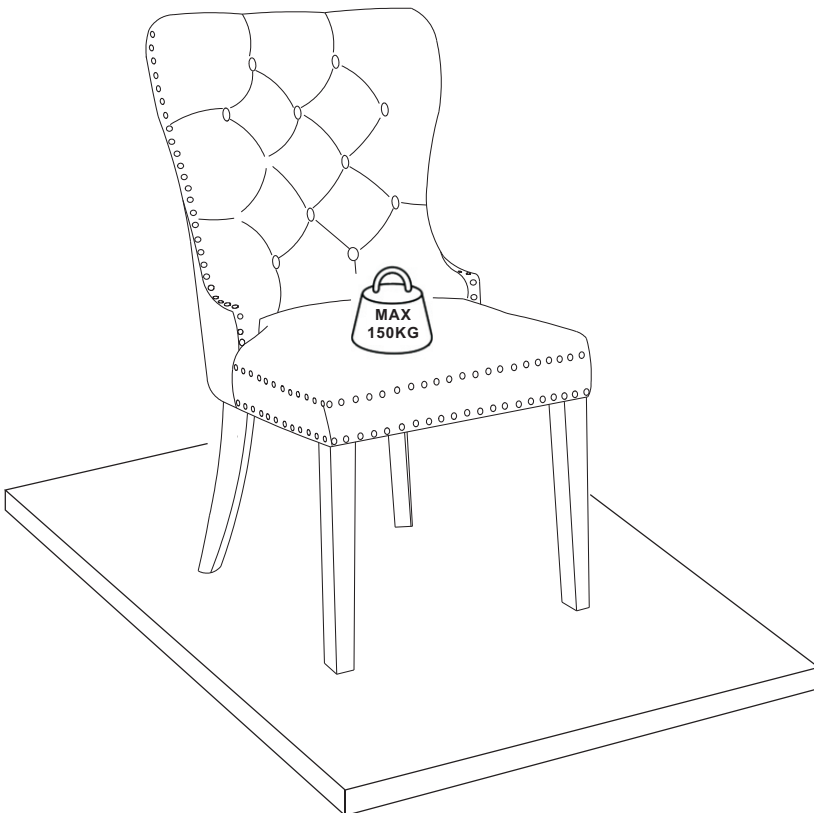

Vor dem Einbau die Schrauben in die Löcher stecken und festziehen, aber nicht bis 100%, 70% bis 80% anziehen reicht aus. Wenn alle vier Beine des Stuhls den Boden berühren können, ohne zu schütteln, ziehen Sie alle Schrauben auf 100%. Wenn Sie auf diese Probleme stoßen, z.B. wenn die Löcher nicht ausgerichtet werden können oder einige Teile nicht installiert werden können, überprüfen Sie bitte, ob die Schrauben korrekt verwendet werden und passen Sie die Dichtheit der Schrauben an.

Insérer la vis dans le trou avant la fin de l'assemblage, serrer la vis, mais ne pas serrer à 100%, 70% ~ 80% est correct. Enfin, si la chaise peut toucher le sol avec ses quatre pieds et ne tremble pas, serrez toutes les vis à 100%. Si vous rencontrez ces problèmes, par exemple si les trous ne sont pas alignés ou si certaines pièces ne peuvent pas être montées, vérifiez que les vis sont utilisées correctement et ajustez leur serrage.

Before installation, insert the screws into the holes and tighten them, but do not tighten them to 100%, 70% to 80% is sufficient. Finally, if all four legs of the chair can touch the ground without shaking, tighten all screws to 100%. If you encounter these issues, such as if the holes cannot be aligned or some parts cannot be installed, please check if the screws are used correctly and adjust the tightness of the screws.