

Safety Instructions

1, 2, 3, 4, 5, 6, 7, 10, 12, 13, 14, 15, 16,
17, 18, 19, 20, 21, 22, 24, 28, 33, 34



Info

www.paulmann.com

Paulmann Licht GmbH
Quezinger Feld 2
31832 Springe
Germany

www.paulmann.com

Art.-Nr.: 942.92
942.93
942.94
942.95
942.96
942.97
942.98
942.99
943.00
943.01
943.02
943.03
943.04
943.05
943.06



942.92_942.94_942.96

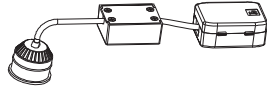

1x

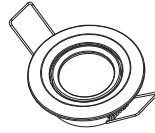

1x



2x

943.06

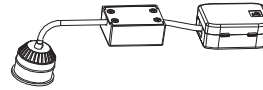

1x



942.93_942.95_942.97

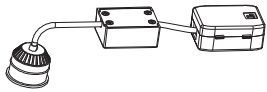

3x

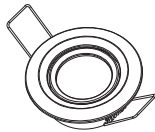

3x



6x



2x

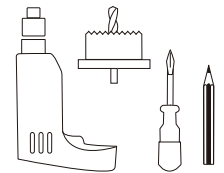

942.98_943.00
943.02_943.04

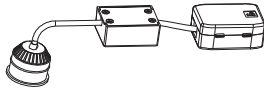

1x

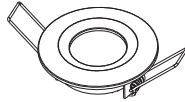

1x

942.99_943.01
943.03_943.05

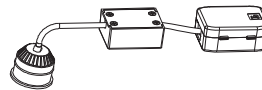

3x



2x

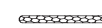

6x

(+MA326) PSPU 01/20

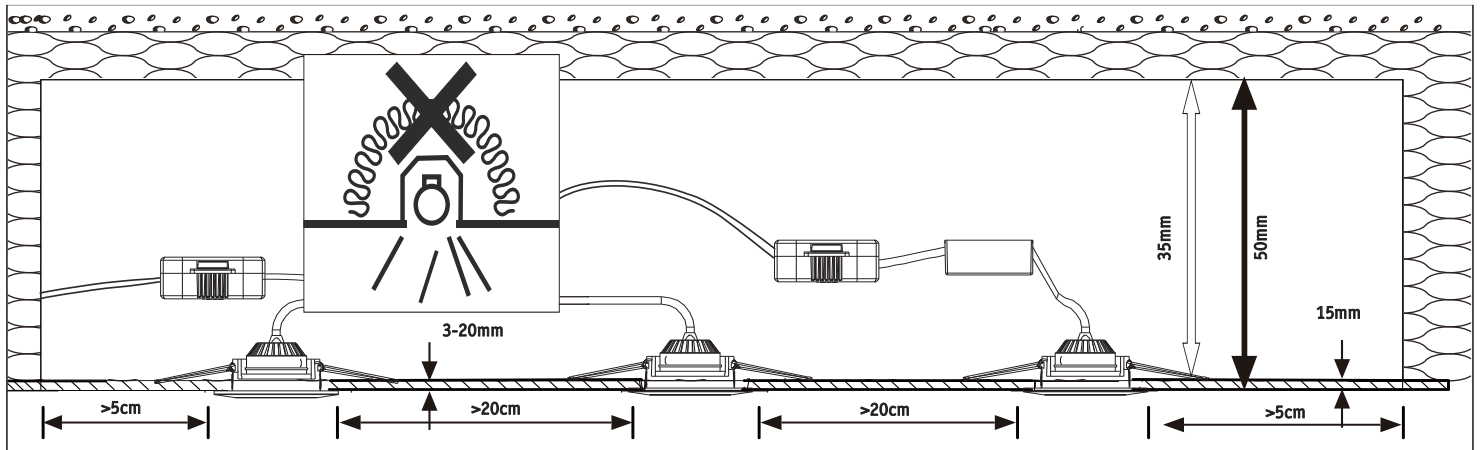

942.92_942.93
942.94_942.95
942.96_942.97

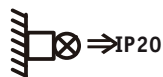

942.98_942.99
943.00_943.01
943.02_943.03
943.04_943.05

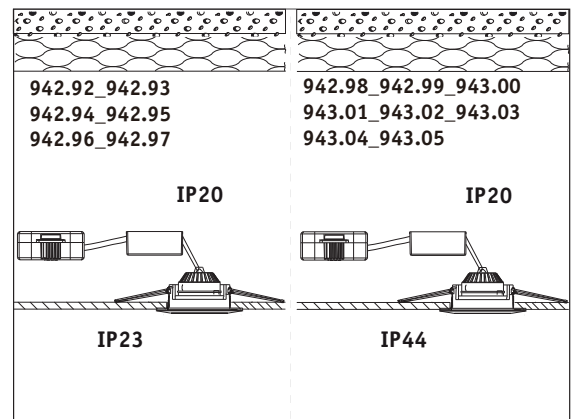
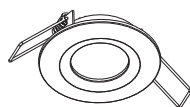
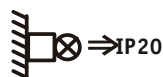

A

Safety Instructions
 Nr. 1, 4, 5, 7 off

item number	hole size
942.92_942.93 942.94_942.95	ø54mm
942.96_942.97	ø55mm
942.98_942.99 943.00_943.01 943.02_943.03 943.04_943.05	ø54mm

ø x mm

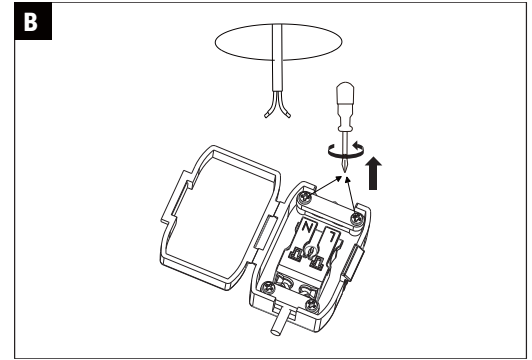

C

a.

b.

Safety Instructions
 Nr. 3, 4, 5, 6

230V~

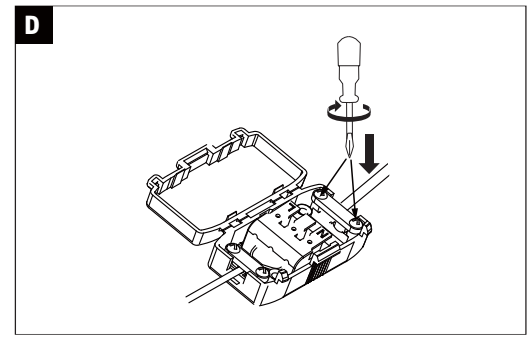

E

230V~

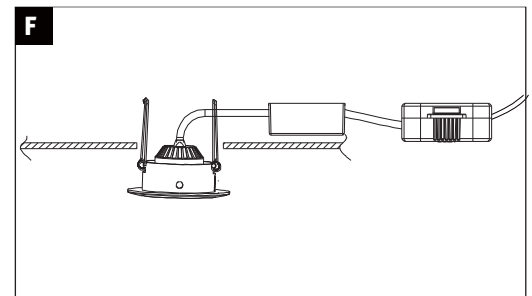

OK

15°

942.92_942.93
942.94_942.95
942.96_942.97

942.98_942.99
943.00_943.01
943.02_943.03
943.04_943.05

ENERGY LABEL

Y IJA IE IA
 энергия · ενεργεια

A++
 A+ **A+**
 A
 B
 C
 D
 E

4 kWh/1000h

300 lm
 4 W
 230 V

warm white
 2700K

CRI/Ra ≥ 80

ON OFF >50.000

Lumen 60% <1 s

≈30x
 1.000h

ø35 mm

CE

21 PAP

390094306