

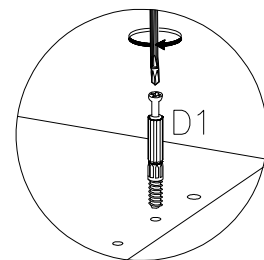

1

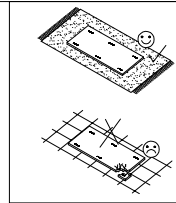

2

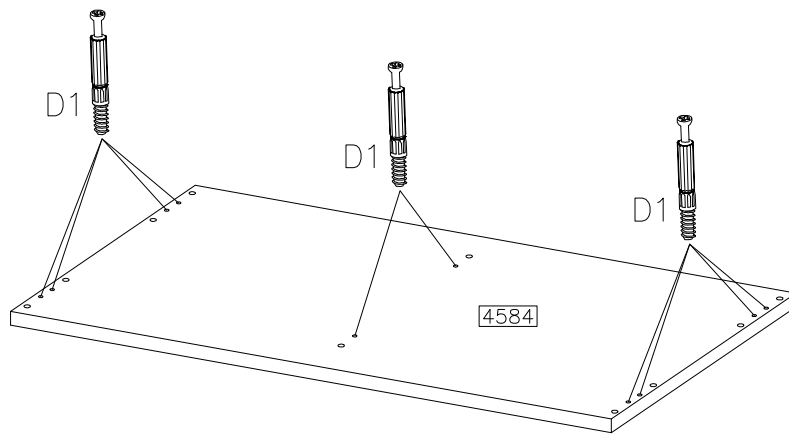
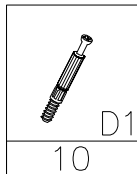
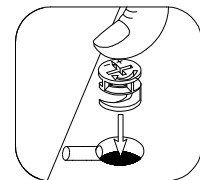
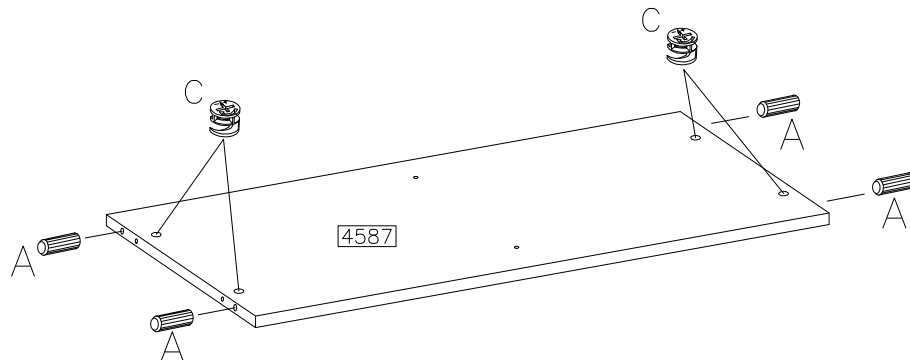
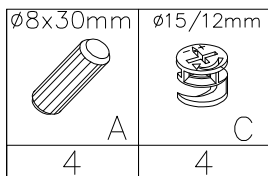

3

2x

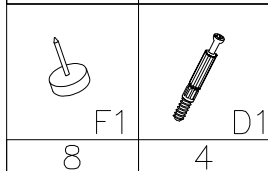
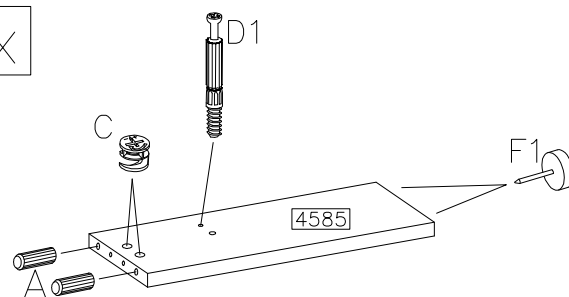
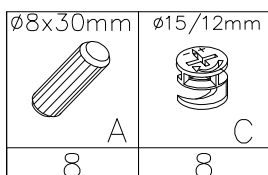

2x

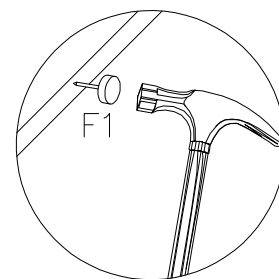
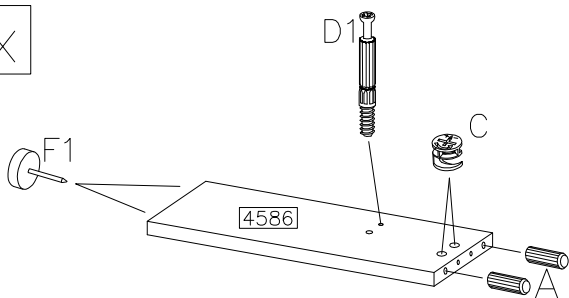

4

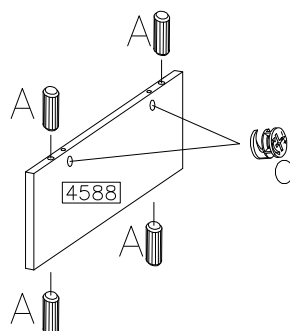
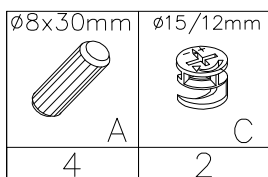

5

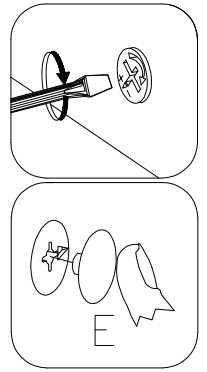
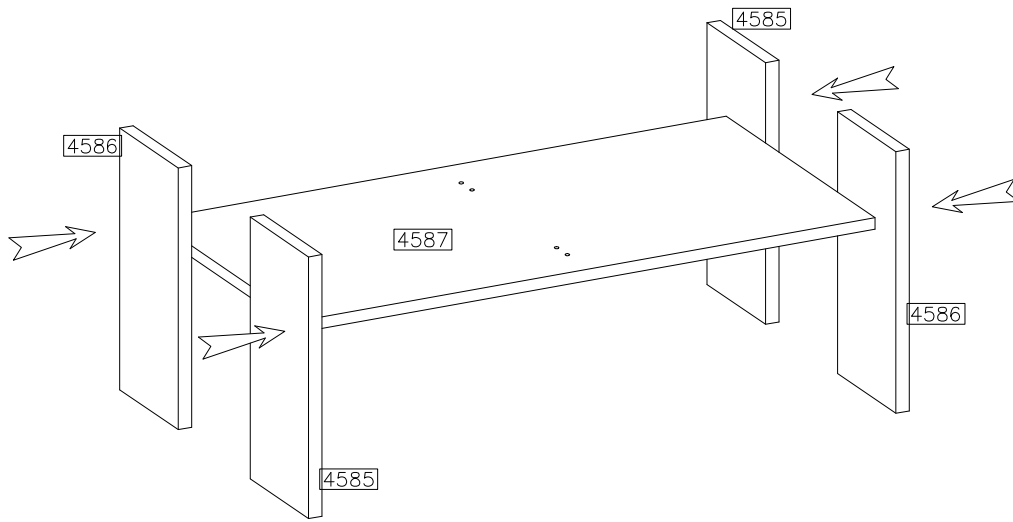
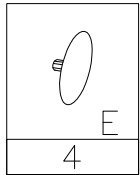

6

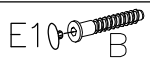
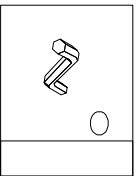
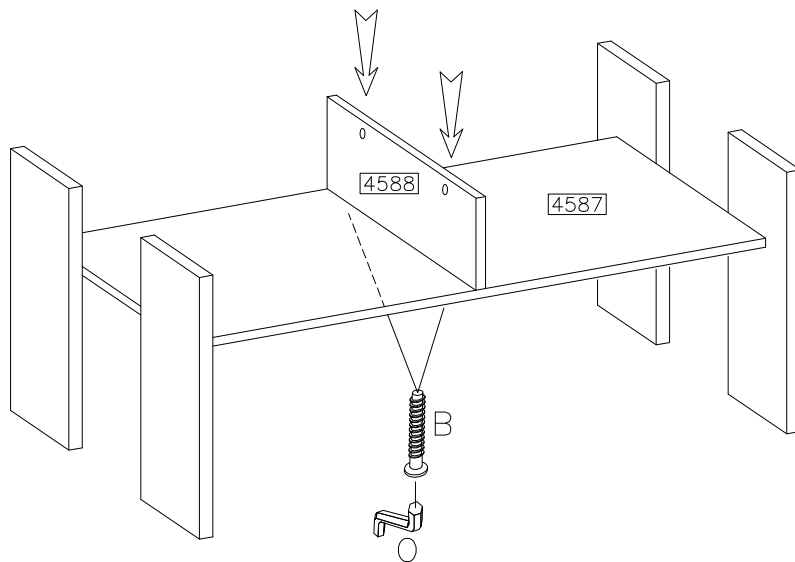
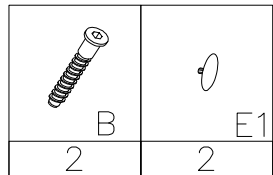

7

