

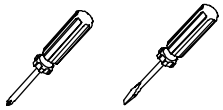









TOOLS:







Thank you for choosing *our products*.

-  • Read instructions, cover to cover
-  • Have 2-4 adults on hand for assembly [depending on product size](#)
-  • Do not assemble [directly](#) on flooring or carpet
-  • Assemble on a clean non-marring surface ([example](#): packing foam)
-  • Save all packaging until finished

Vielen Dank, dass Sie sich für unsere Produkte entschieden haben.

-  • Lesen Sie die Anleitungen von der ersten bis zur letzten Seite.
-  • Je nach Größe des Produkts sollten 2-4 Erwachsene für die Montage zur Verfügung stehen.
-  • Montieren Sie das Produkt nicht direkt auf dem Fußboden oder Teppich.
-  • Montieren Sie das Produkt auf einer sauberen, nicht federnden Oberfläche (z. B. Verpackungsschaum).
-  • Bewahren Sie alle Verpackungen bis zur Fertigstellung auf.

Merci d'avoir choisi nos produits

-  • Lisez les instructions de bout en bout.
-  • Prévoyez 2 à 4 adultes pour l'assemblage selon la taille du produit.
-  • N'assemblez pas directement sur un sol ou un tapis.
-  • Assemblez sur une surface propre et non marquante (par exemple : de la mousse de protection).
-  • Conservez tous les emballages jusqu'à la fin.

Dear Customer,

- If you encounter any problems during assembly and find that you cannot continue, rest assured we will help you solve the situation as soon as possible. Simply keep all of the parts of the product stored in a safe place and contact us immediately so we may assist you further.
- Once you have opened your package, remove all inner hardware packages and take the parts out. One by one, Place the parts out neatly in front of you, then refer to the instructions to ensure no parts are missing. If any pieces are found missing, please carefully look in the box first, as the hardware packaging might have torn making the hardware spill in the box.
- **IMPORTANT:** When setting up your product, **DO NOT INSTALL THE SCREWS ALL THE WAY IN THE BEGINNING.** Place each screw into their proper hole and use your hand to twist the screw halfway. Twist all the screws in halfway to ensure the holes will match up properly and the product is level on the ground. When everything seems fitted, then tighten the screws.
- When you have completed assembly, we suggest you have more than one person to assist you with lifting and placing the product.

Sehr geehrter Kunde,

- Sollten Sie bei der Montage auf Probleme stoßen und nicht weitermachen können, werden wir Ihnen so schnell wie möglich helfen, das Problem zu lösen. Bewahren Sie einfach alle Teile des Produkts an einem sicheren Ort auf und kontaktieren Sie uns umgehend, damit wir Ihnen weiterhelfen können.
- Sobald Sie Ihr Paket geöffnet haben, entfernen Sie alle inneren Hardware-Verpackungen und nehmen Sie die Teile heraus. Legen Sie die Teile einzeln und ordentlich vor sich aus und überprüfen Sie anhand der Anleitung, ob keine Teile fehlen. Sollten Teile fehlen, schauen Sie bitte zuerst in der Schachtel nach, da die Verpackung gerissen sein könnte, so dass die Teile in der Verpackung verschüttet wurden.
- **WICHTIG:** Wenn Sie Ihr Produkt aufstellen, **DREHEN SIE DIE SCHRAUBEN NICHT VON**











ANFANG AN GANZ EIN. Setzen Sie jede Schraube in das entsprechende Loch und drehen Sie die Schraube mit der Hand halb ein. Drehen Sie alle Schrauben bis zur Hälfte ein, um sicherzustellen, dass die Löcher richtig übereinstimmen und das Produkt waagrecht auf dem Boden steht. Wenn alles zu passen scheint, ziehen Sie die Schrauben fest.

- Wenn Sie die Montage abgeschlossen haben, empfehlen wir Ihnen, sich beim Anheben und Aufstellen des Produkts von mehreren Personen helfen zu lassen.

Cher client,

- Si vous rencontrez des problèmes lors de l'assemblage et que vous ne pouvez pas continuer, soyez assuré(e) que nous vous aiderons à résoudre la situation dès que possible. Rangez simplement toutes les pièces du produit dans un endroit sûr et contactez-nous immédiatement afin que nous puissions vous apporter une assistance supplémentaire.
- Une fois que vous avez ouvert votre colis, retirez tous les emballages intérieurs contenant les pièces et sortez-les. Placez les pièces une par une devant vous de manière ordonnée, puis consultez les instructions pour vérifier qu'aucune pièce ne manque. Si vous constatez des pièces manquantes, veuillez examiner attentivement la boîte en premier lieu, car l'emballage des pièces détachées pourrait s'être déchiré, entraînant leur dispersion dans la boîte.
- **IMPORTANT** : Lors de la configuration de votre produit, **NE VISSEZ PAS LES VIS ENTièrement AU DÉBUT**. Placez chaque vis dans son trou approprié et utilisez votre main pour les tourner à mi-chemin. Tournez toutes les vis à mi-chemin pour vous assurer que les trous s'aligneront correctement et que le produit est de niveau sur le sol. Lorsque tout semble bien ajusté, serrez ensuite les vis.
- Lorsque vous avez terminé l'assemblage, nous vous suggérons de faire appel à plus d'une personne pour vous aider à soulever et placer le produit.

Care & Maintenance







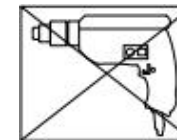













-  ● Do not put hot items directly on furniture surface
-  ● Do not clean furniture with harsh cleansers or polish
-  ● Do not place furniture under direct sunlight
-  ● Do not place furniture near heating or cooling vents
-  ● Do not write on furniture without a padded barrier to protect the surface
-  ● Do not place furniture outside. For indoor use only
-  ● Not for commercial use. For residential use only
-  ● Stains may be removed with mild soap solution and damp cloth
-  ● Children should not climb or jump on the furniture
-  ● Dust and pick-up spills using a clean, non-colored, lint-free cloth

Caution

- This product contains small components. Please ensure that they are kept away from small children.
- Do not use power tools to assemble your furniture. Power tools may strip or damage the parts.



Pflege & Wartung





















-   ● Stellen Sie keine heißen Gegenstände direkt auf die Möbeloberfläche.
-   ● Reinigen Sie die Möbel nicht mit scharfen Reinigungsmitteln oder Polituren.
-   ● Setzen Sie die Möbel nicht dem direkten Sonnenlicht aus.
-   ● Stellen Sie die Möbel nicht in der Nähe von Heizungs- oder Kühlungsöffnungen auf.
-   ● Schreiben Sie nicht auf Möbeln ohne eine gepolsterte Unterlage zum Schutz der Oberfläche.
-   ● Stellen Sie die Möbel nicht im Freien auf. Nur für den Innenbereich geeignet.
-   ● Nicht für den gewerblichen Gebrauch. Nur für den privaten Gebrauch.
-   ● Flecken können mit einer milden Seifenlösung und einem feuchten Tuch entfernt werden.
-   ● Kinder sollten nicht auf die Möbel klettern oder springen.
-   ● Verschmutzungen mit einem sauberen, nicht gefärbten, fusselfreien Tuch abstauben und aufnehmen.

Vorsicht

- Dieses Produkt enthält Kleinteile. Bitte achten Sie darauf, dass diese von kleinen Kindern ferngehalten werden.
- Verwenden Sie keine Elektrowerkzeuge für den Zusammenbau Ihrer Möbel. Elektrowerkzeuge können die Teile ablösen oder beschädigen.



Entretien et maintenance

-   ● Ne placez pas d'objets chauds directement sur la surface du mobilier.
-   ● N'utilisez pas de nettoyeurs agressifs ou de produits de polissage pour le mobilier.
-   ● Ne placez pas le mobilier en plein soleil.
-   ● Ne placez pas le mobilier près des conduits de chauffage ou de refroidissement.
-   ● N'écrivez pas sur le mobilier sans une protection rembourrée pour préserver la surface.
-   ● Ne placez pas le mobilier à l'extérieur. Utilisation uniquement en intérieur.
-   ● Non destiné à un usage commercial. Pour un usage résidentiel uniquement.
-   ● Les taches peuvent être éliminées avec une solution de savon doux et un chiffon humide.
-   ● Les enfants ne doivent pas grimper ou sauter sur le mobilier.
-   ● Époussetez et essuyez les déversements avec un chiffon propre, non coloré et sans peluches.

Prudence

- Ce produit contient de petites pièces. Veillez à les tenir hors de portée des jeunes enfants.
- N'utilisez pas d'outils électriques pour assembler votre mobilier. Les outils électriques peuvent endommager ou détériorer les pièces.

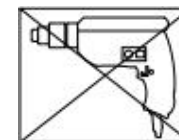

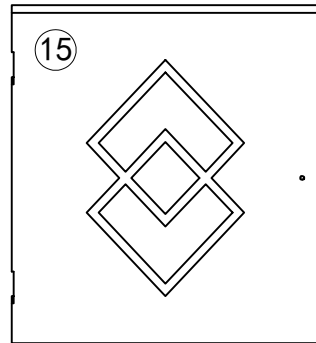
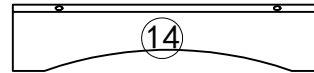
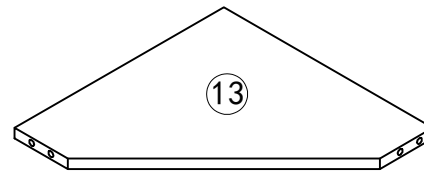
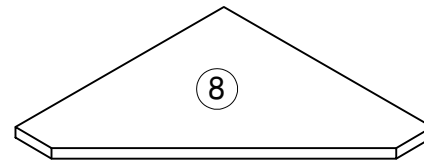
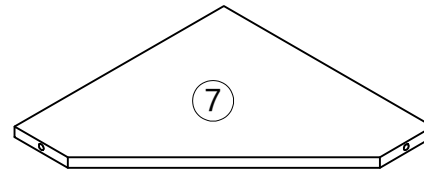
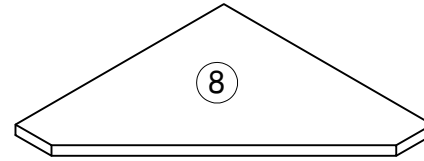
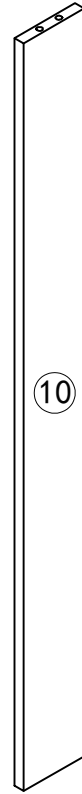
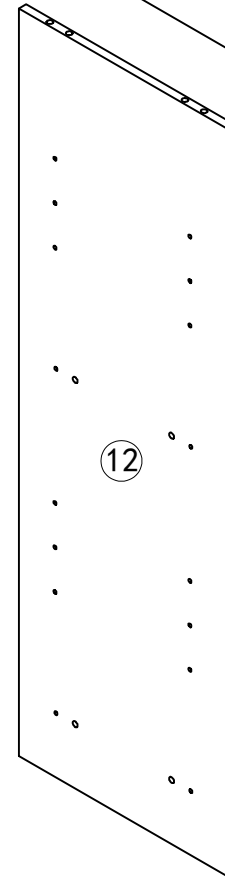
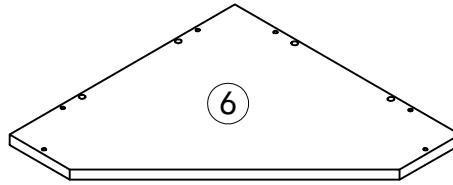
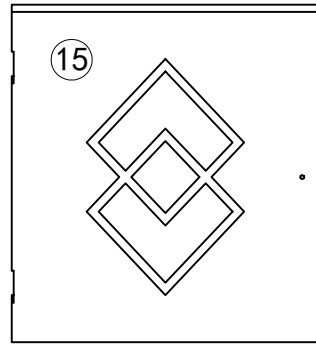
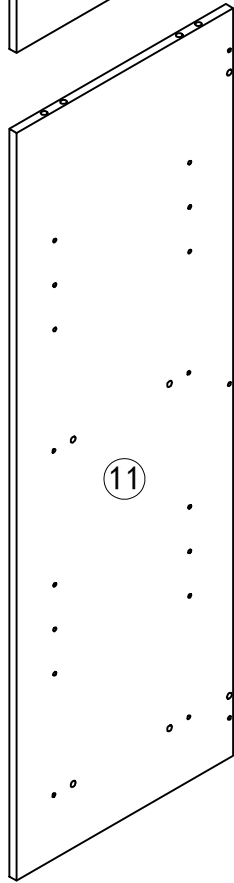
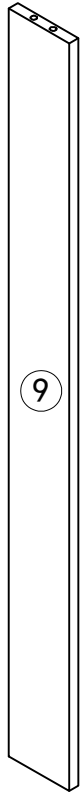
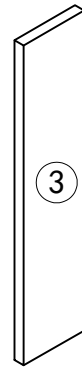
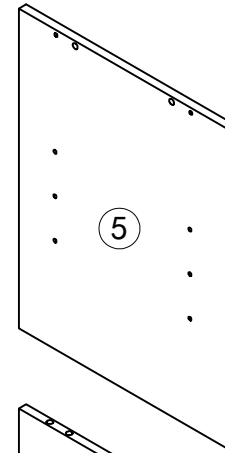
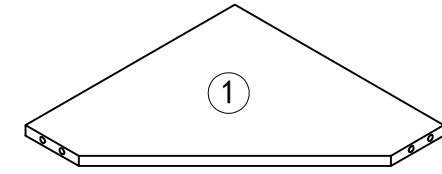
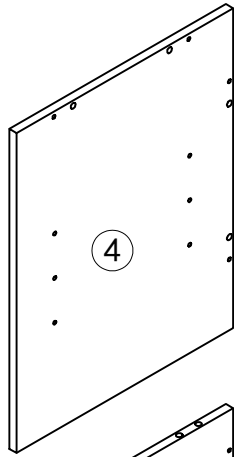
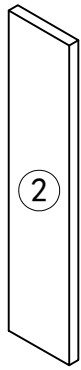

UNIT:MM
PACKAGE-A

EINHEIT:MM
PAKET-A

UNITÉ:MM
PAQUET-A

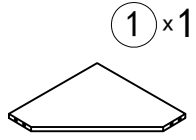

347x347x15mm

②x1



460x100x15mm

③x1



460x100x15mm

④x1

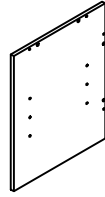

460x359x12mm

⑤x1

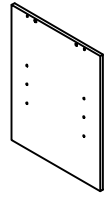

460x347x12mm

⑥x1

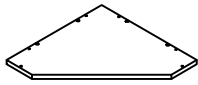

374x374x15mm

⑦x1

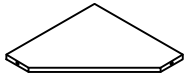

347x347x15mm

⑧x2

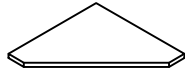

346x346x15mm

⑨x1



1075x100x15mm

⑩x1



1075x100x15mm

⑪x1

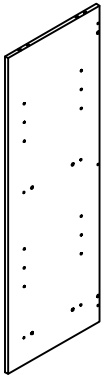

1075x359x12mm

⑫x1

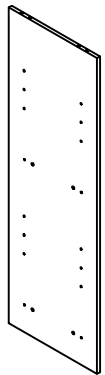

1075x347x12mm

⑬x1

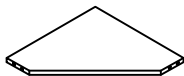

347x347x15mm

⑭x1



365x85x15mm

⑮x2

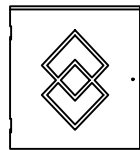

474x361x12mm

PACKAGE-B

PAKET-B

PAQUET-B

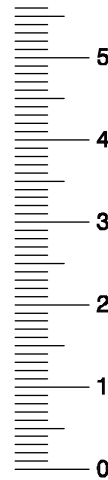

UNIT:MM
EINHEIT:MM
UNITÉ:MM

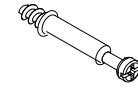

6x35mm

Ax37



15x10mm

Bx37

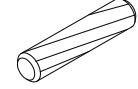

8x30mm

Cx30

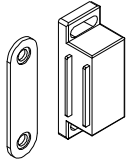

Dx2



M3x12mm

Ex20



M3x16mm

Fx4



Gx2



Hx2



Jx8

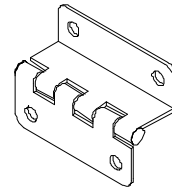

Kx4

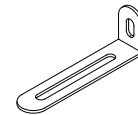

Lx1

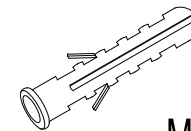

Mx1

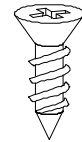

M3.5x14mm



Nx1





M4x35mm

Px1

BOLT INSTALLATION AS BELOW



 BOLT
 Connecting piece

 X
 Ad. just connecting piece direction if condition as illustrated

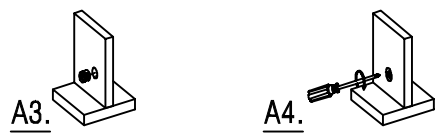
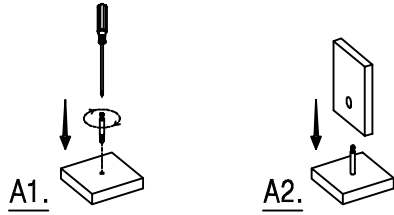
 ✓
 Insert bolt when Connecting piece under Such condition



BOLZENMONTAGE WIE UNTEN



 BOLZEN
 Verbundene Teile

 X
 nur Verbindungsstück Richtung wenn Zustand wie abgebildet

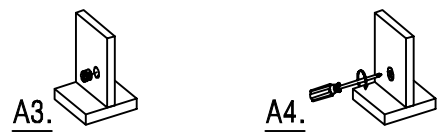
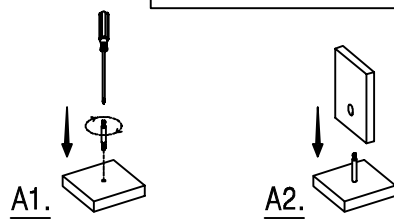
 ✓
 Schraube einfügen, wenn Verbindungsstück unter solcher Bedingung



INSTALLATION DU BOULON COMME SUIV

 BOULON
 Installation de la pièce de connexion

 X
 Ajustez la direction de la pièce de connexion si nécessaire, selon l'illustration.

 ✓
 Insérez le boulon lorsque la pièce de connexion est dans cette condition

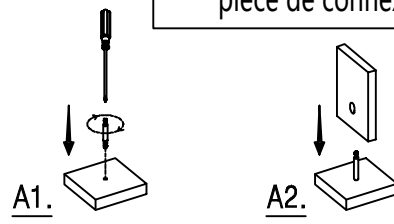

1

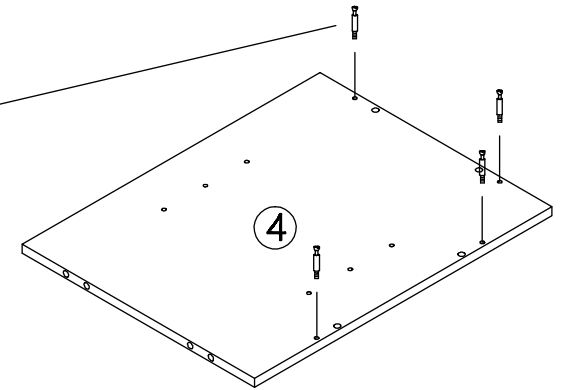
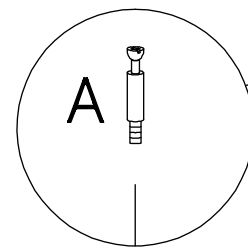
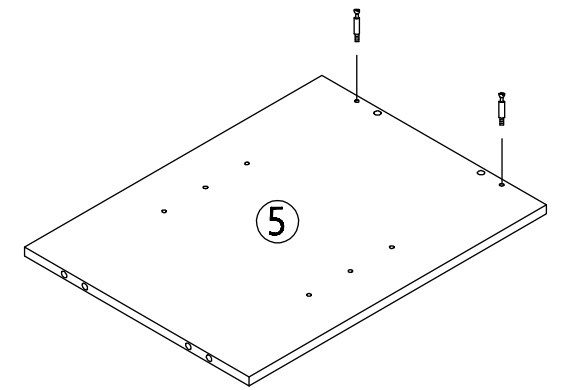
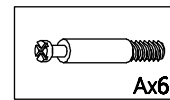

2

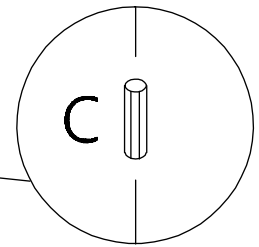
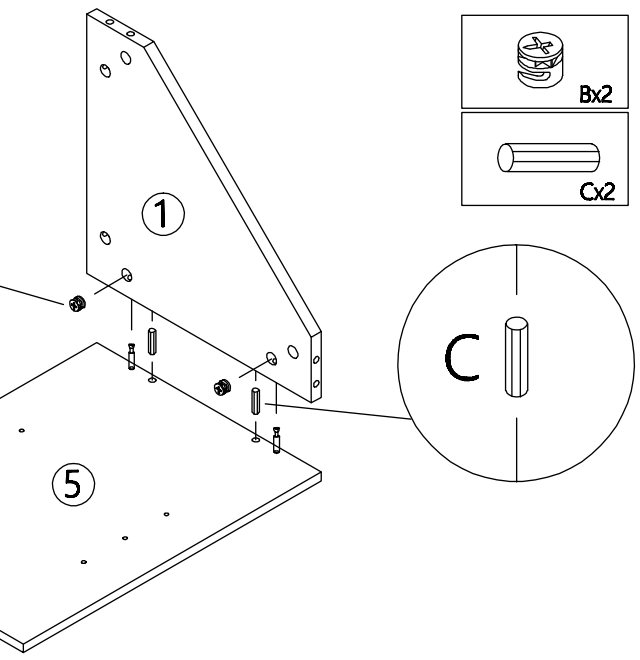
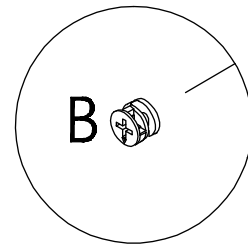

3

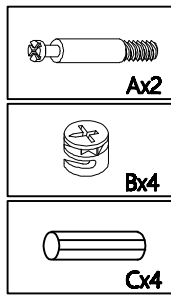
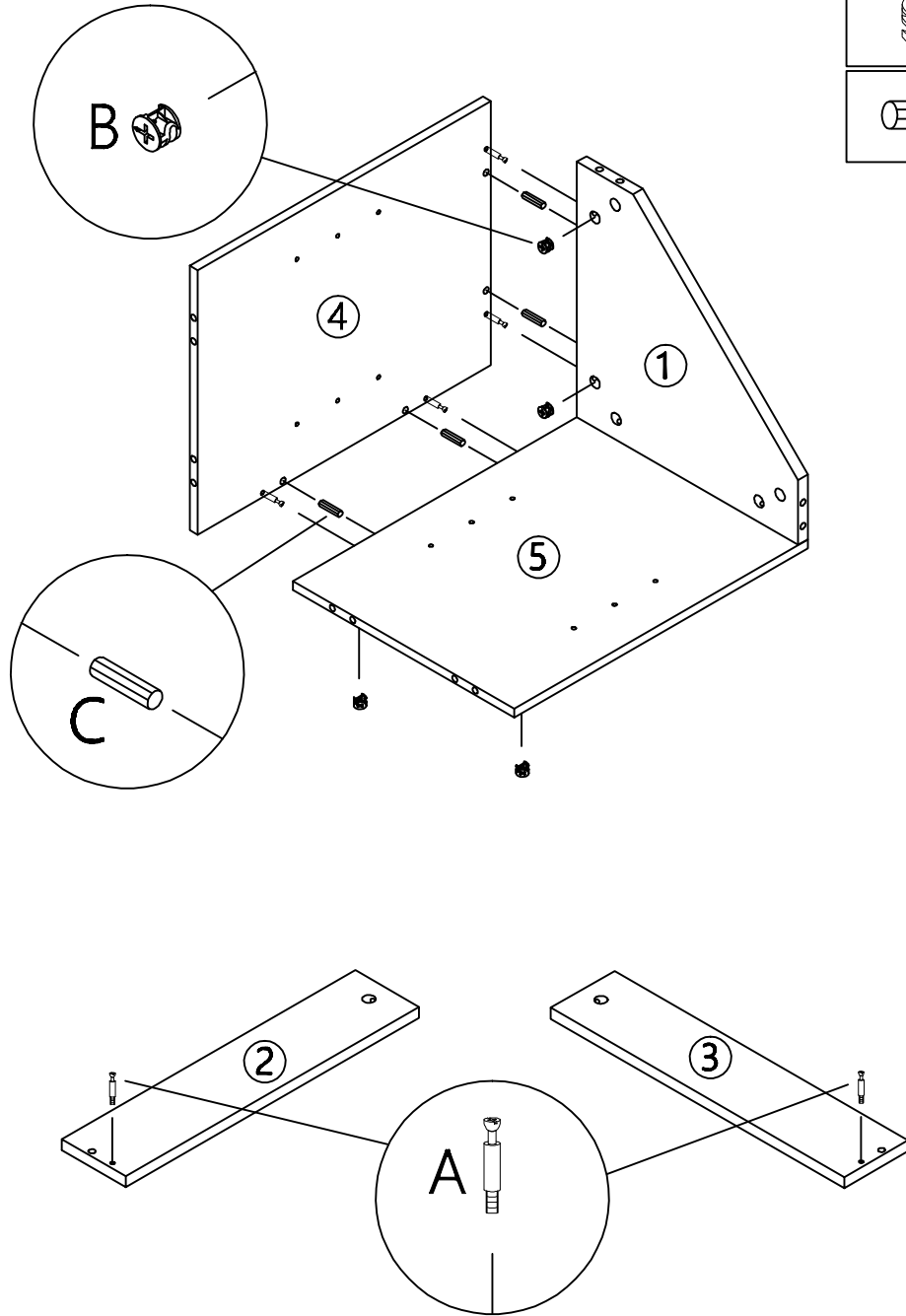

4

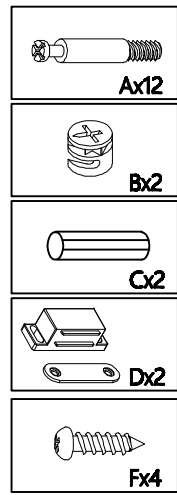
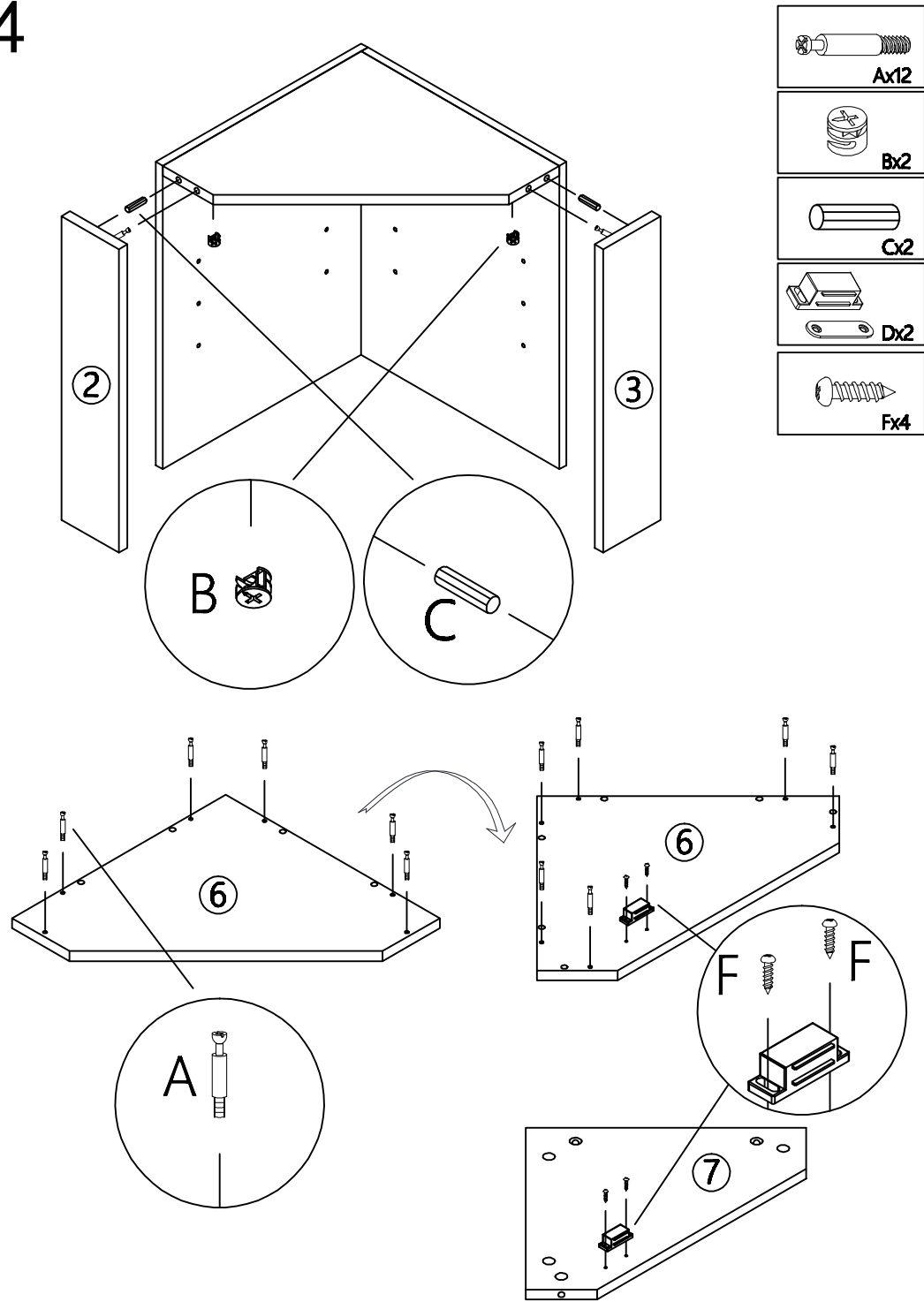

5

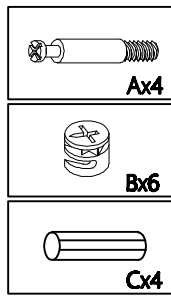
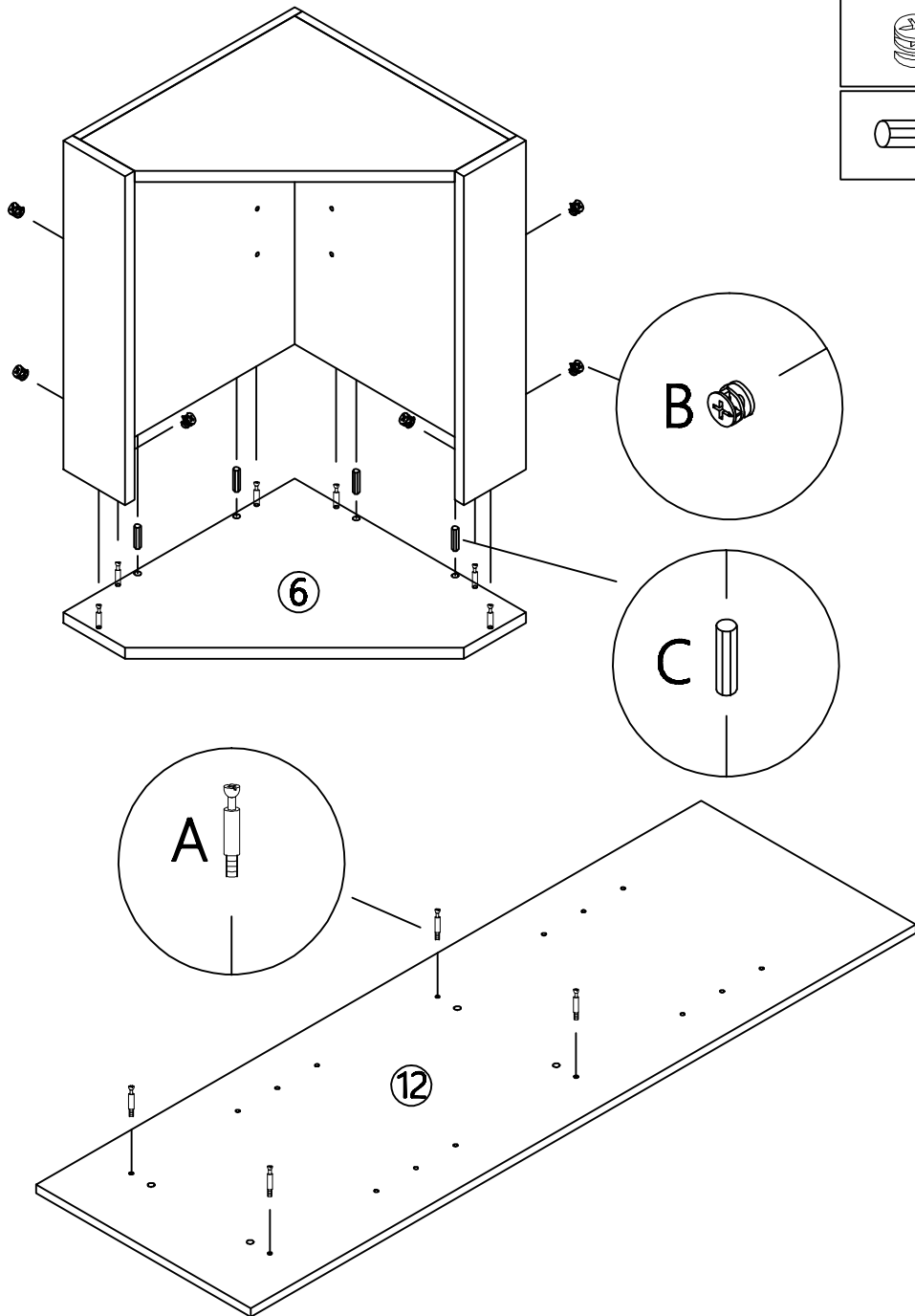

6

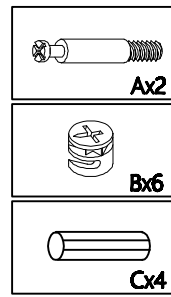
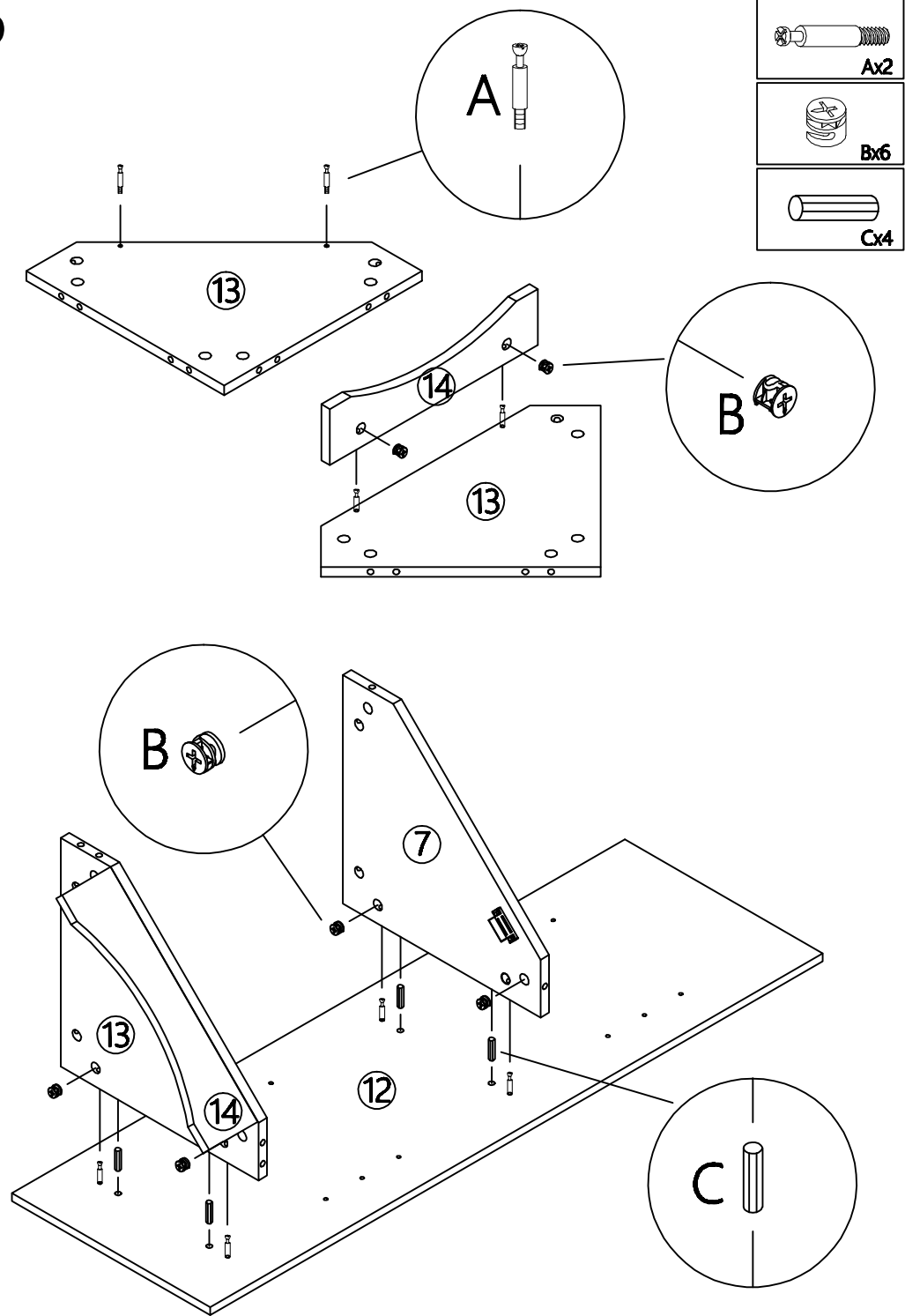

7

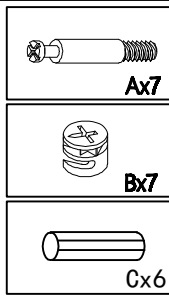
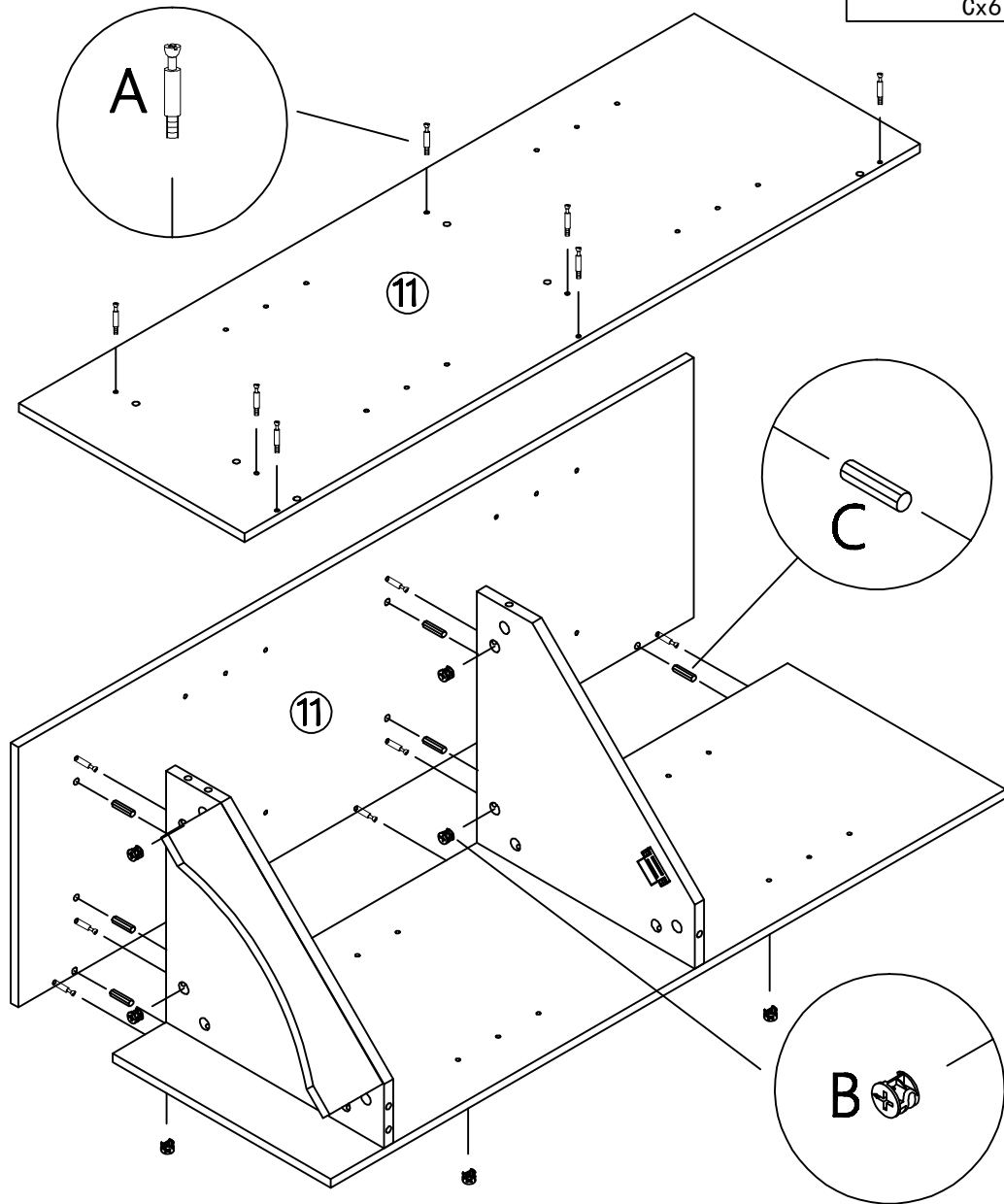

8

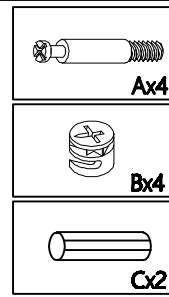
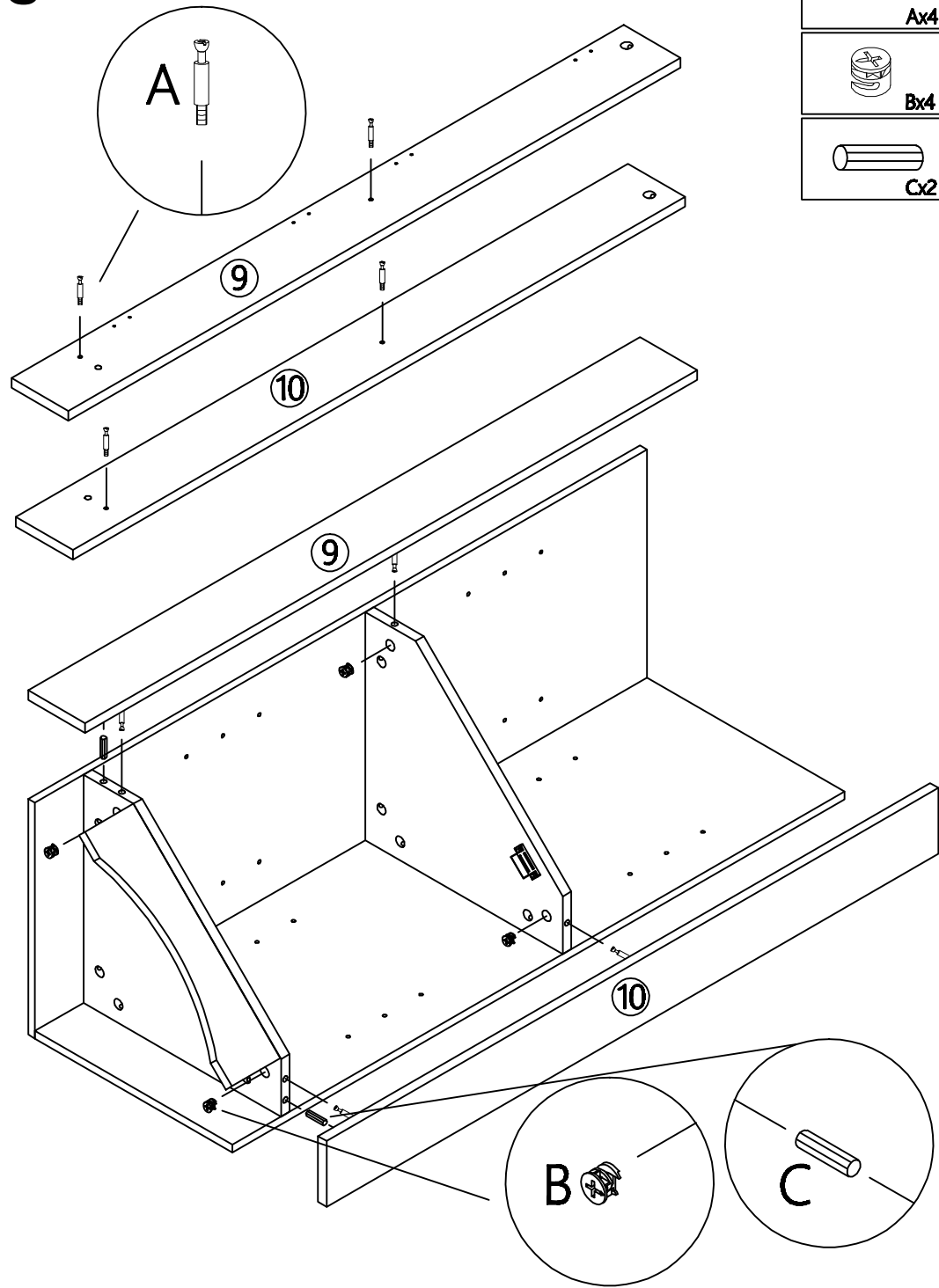

9

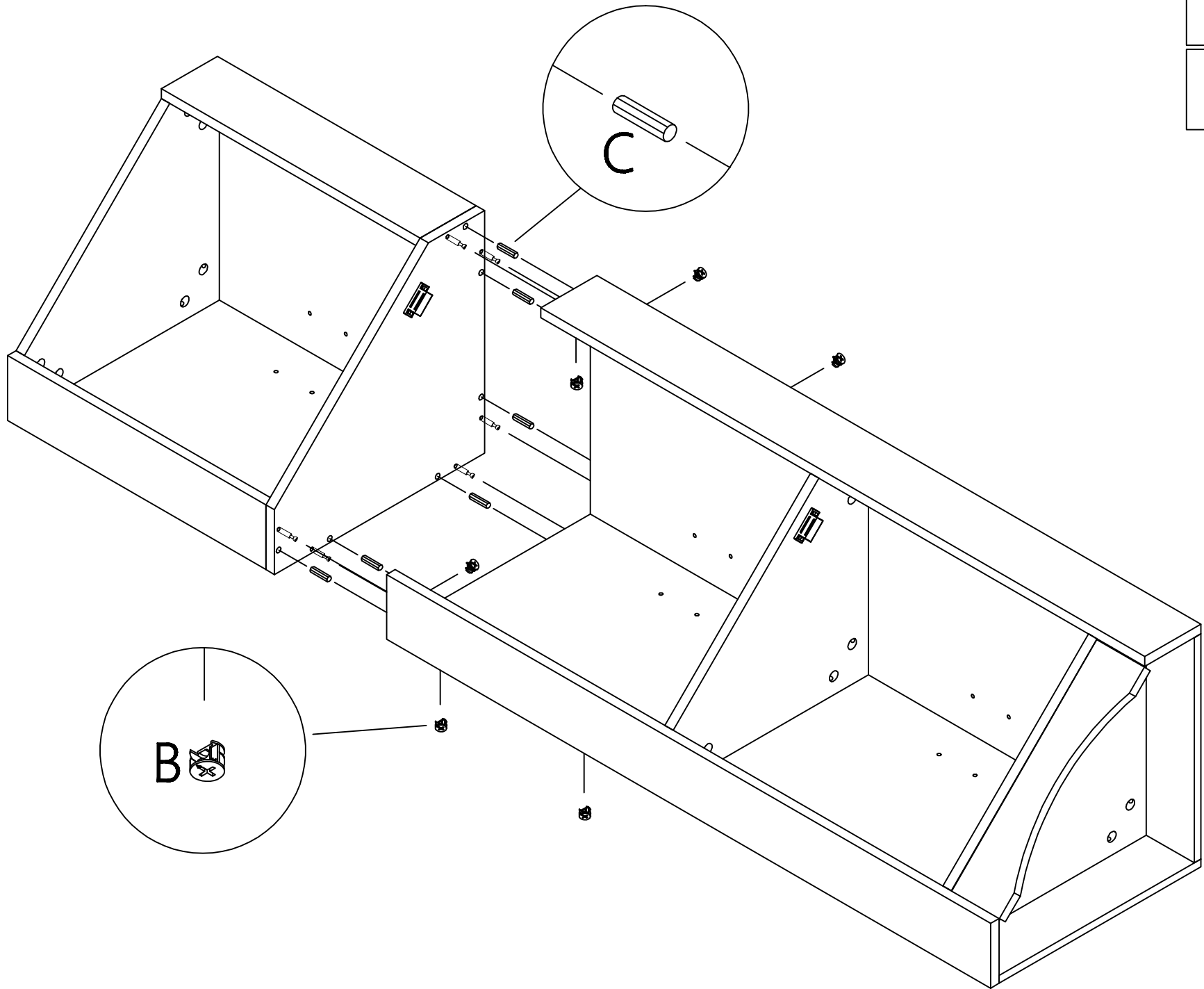

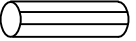
	Bx6
	Cx6

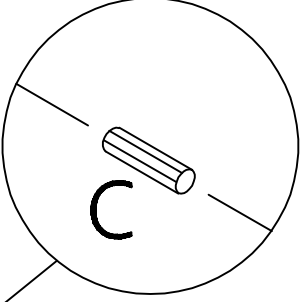
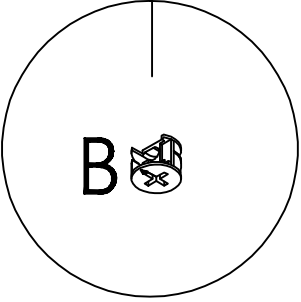



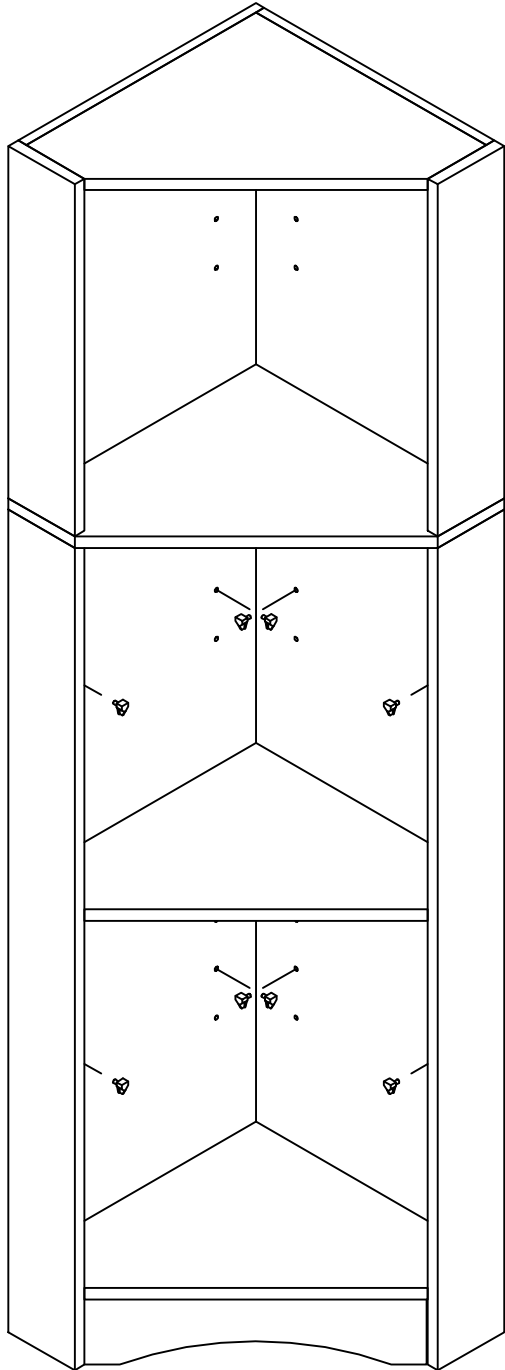
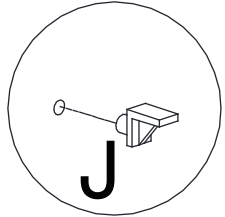
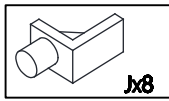

10

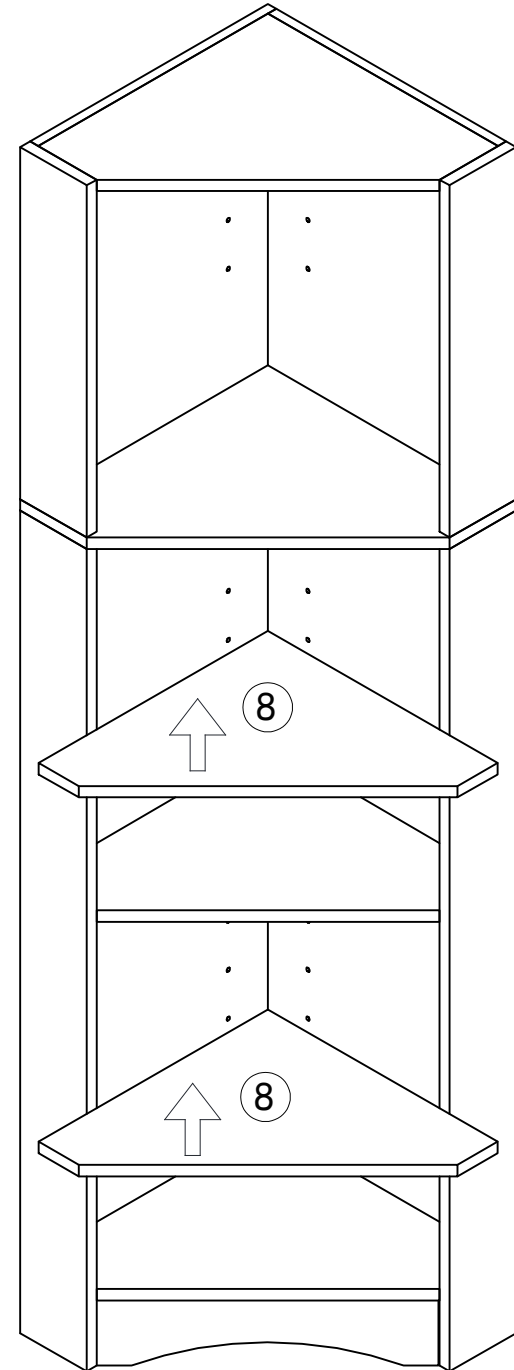

11

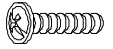

12

- 
Gx2
- 
Hx2
- 
Kx4
- 
Ex12

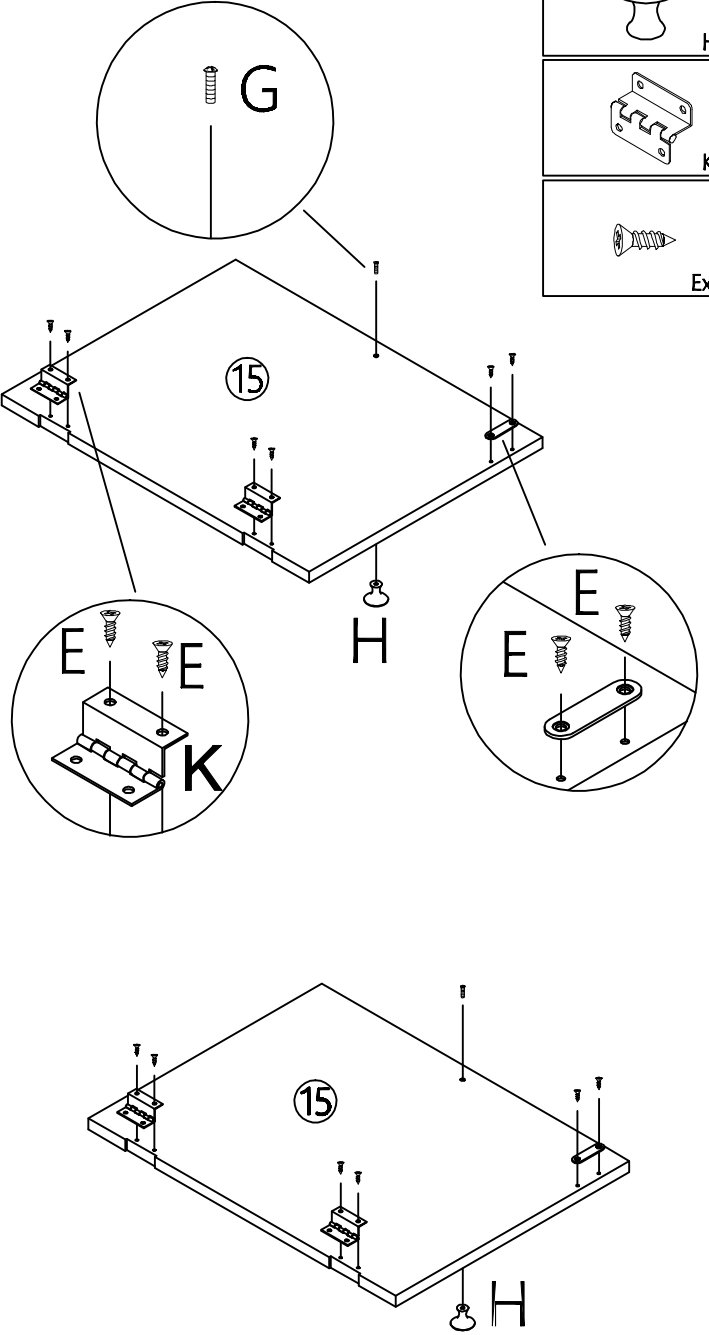

13

- 
Ex8

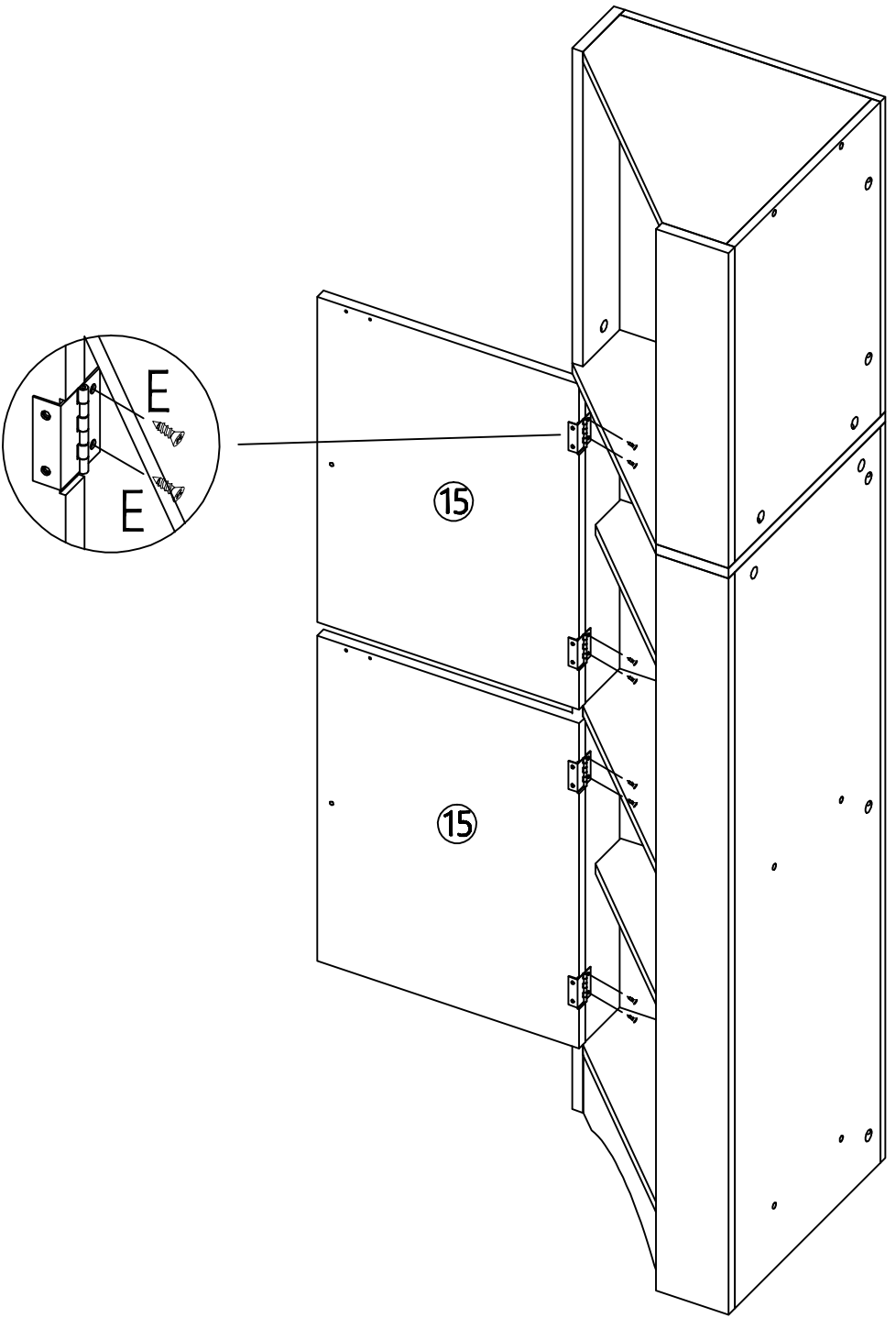

14

