

# 92728 98175 98734

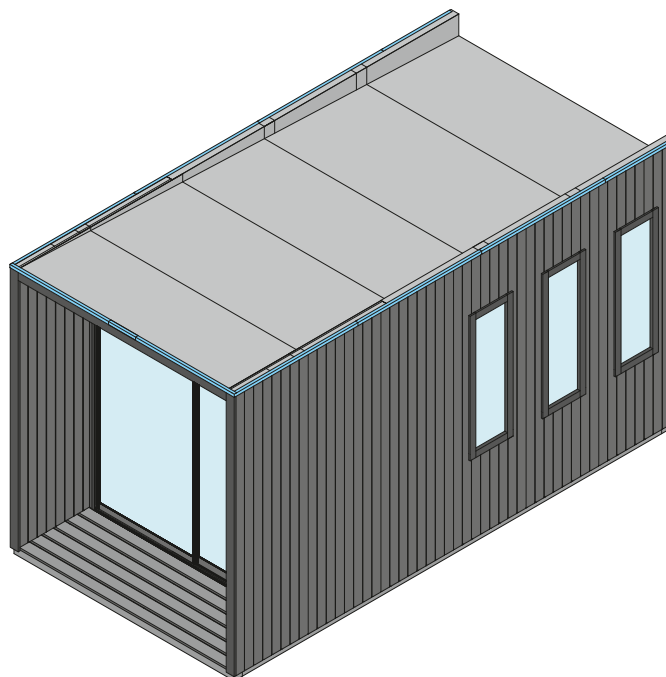

-  **Aufbauanleitung**
-  **Building Instructions**
-  **notice de montage**
-  **montagehandleiding**
-  **Montagevejledning**
-  **Instrucciones de construcción**
-  **Istruzioni per il montaggio**
-  **Montážní návod**
-  **Navodila za sestavljanje**

**Technische Daten**

In der Auftragsbestätigung bzw. Lieferschein ist der gekaufte Ofentyp bzw. das erworbene Steuergerät zu finden. Bitte entnehmen Sie die technischen Daten Ihrer Geräte der folgenden Auflistung

	<b>Netzspannung</b>	<b>Wattage</b>
<b>Ofen</b>		
9kW Bio	400V ~ 3N	9kW
9kW Finnisch	400V ~ 3N	9kW
9kW integr. Steuerung	400V ~ 3N	9kW
4,5kW Bio	400V ~ 3N	4,5kW
4,5kW Finnisch	400V ~ 3N	4,5kW
4,5kW integr. Steuerung	400V ~ 3N	4,5kW
3,6kW Bio	230V ~ 1N	3,6kW
3,6kW Finnisch	230V ~ 1N	3,6kW
3,6kW integr. Steuerung	230V ~ 1N	3,6kW
<b>Steuergerät</b>		
externe Easy Bio	400V ~ 3N	max. 10,8kW
externe Plug&Play Bio	240V ~ 3N	max. 10,8kW
externe Finnisch	400V ~ 3N	max. 10,8kW
externe Plug&Play Finnisch	240V ~ 3N	max. 10,8kW
Multisteuergerät	400V ~ 3N	max. 10,5kW
externe Classic Bio	400V ~ 3N	max. 9kW
externe Classic Finnisch	400V ~ 3N	max. 9kW
externe Premium Bio	400V ~ 3N	max. 12kW
externe Premium Finnisch	400V ~ 3N	max. 9kW

**Technical data**

The type of oven or control unit purchased can be found in the order confirmation or delivery note. Please refer to the following list for the technical data of your units

	<b>Mains voltage</b>	<b>Wattage</b>
<b>Oven</b>		
9kW Bio	400V ~ 3N	9kW
9kW Finnisch	400V ~ 3N	9kW
9kW integrated Control unit	400V ~ 3N	9kW
4,5kW Bio	400V ~ 3N	4,5kW
4,5kW Finnisch	400V ~ 3N	4,5kW
4,5kW integrated Control unit	400V ~ 3N	4,5kW
3,6kW Bio	230V ~ 1N	3,6kW
3,6kW Finnisch	230V ~ 1N	3,6kW
3,6kW integrated Control unit	230V ~ 1N	3,6kW
<b>Control unit</b>		
External Easy Bio	400V ~ 3N	max. 10,8kW
External Plug&Play Bio	240V ~ 3N	max. 10,8kW
External Finnisch	400V ~ 3N	max. 10,8kW
External Plug&Play Finnisch	240V ~ 3N	max. 10,8kW
Multi-controller	400V ~ 3N	max. 10,5kW
External Classic Bio	400V ~ 3N	max. 9kW
External Classic Finnisch	400V ~ 3N	max. 9kW
External Premium Bio	400V ~ 3N	max. 12kW
External Premium Finnisch	400V ~ 3N	max. 9kW

## Données techniques

Dans la confirmation de commande ou le bon de livraison, vous trouverez le type de four ou l'appareil de commande que vous avez acheté. Veuillez consulter les données techniques de vos appareils dans la liste suivante

	Tension du réseau	Wattage
<b>Four</b>		
9kW Bio	400V ~ 3N	9kW
9kW Finnisch	400V ~ 3N	9kW
9kW intégré Unité de contrôle	400V ~ 3N	9kW
4,5kW Bio	400V ~ 3N	4,5kW
4,5kW Finnisch	400V ~ 3N	4,5kW
4,5kW intégré Unité de contrôle	400V ~ 3N	4,5kW
3,6kW Bio	230V ~ 1N	3,6kW
3,6kW Finnisch	230V ~ 1N	3,6kW
3,6kW intégré Unité de contrôle	230V ~ 1N	3,6kW
<b>Unité de contrôle</b>		
Externe Easy Bio	400V ~ 3N	max. 10,8kW
Externe Plug&Play Bio	240V ~ 3N	max. 10,8kW
Externe Finnisch	400V ~ 3N	max. 10,8kW
Externe Plug&Play Finnisch	240V ~ 3N	max. 10,8kW
Appareil de commande multiple	400V ~ 3N	max. 10,5kW
Externe Classic Bio	400V ~ 3N	max. 9kW
Externe Classic Finnisch	400V ~ 3N	max. 9kW
Externe Premium Bio	400V ~ 3N	max. 12kW
Externe Premium Finnisch	400V ~ 3N	max. 9kW

## Technische gegevens

Het type oven of besturingseenheid dat u hebt gekocht, vindt u in de orderbevestiging of leveringsbon. Raadpleeg de volgende lijst voor de technische gegevens van uw apparaten

	Netspanning	Wattage
<b>Oven</b>		
9kW Bio	400V ~ 3N	9kW
9kW Finnisch	400V ~ 3N	9kW
9kW geïntegreerd Besturingseenheid	400V ~ 3N	9kW
4,5kW Bio	400V ~ 3N	4,5kW
4,5kW Finnisch	400V ~ 3N	4,5kW
4,5kW geïntegreerd Besturingseenheid	400V ~ 3N	4,5kW
3,6kW Bio	230V ~ 1N	3,6kW
3,6kW Finnisch	230V ~ 1N	3,6kW
3,6kW geïntegreerd Besturingseenheid	230V ~ 1N	3,6kW
<b>Besturingseenheid</b>		
Extern Easy Bio	400V ~ 3N	max. 10,8kW
Extern Plug&Play Bio	240V ~ 3N	max. 10,8kW
Extern Finnisch	400V ~ 3N	max. 10,8kW
Extern Plug&Play Finnisch	240V ~ 3N	max. 10,8kW
Multi-controller	400V ~ 3N	max. 10,5kW
Extern Classic Bio	400V ~ 3N	max. 9kW
Extern Classic Finnisch	400V ~ 3N	max. 9kW
Extern Premium Bio	400V ~ 3N	max. 12kW
Extern Premium Finnisch	400V ~ 3N	max. 9kW

## Tekniske data

Hvilken type ovn eller styreenhed, du har købt, fremgår af ordrebekræftelsen eller følgesedlen. Se venligst følgende liste for de tekniske data for dine enheder

	<b>Netspænding</b>	<b>Wattforbrug</b>
<b>Ovn</b>		
9kW Bio	400V ~ 3N	9kW
9kW Finnisch	400V ~ 3N	9kW
9kW integreret Kontrolenhed	400V ~ 3N	9kW
4,5kW Bio	400V ~ 3N	4,5kW
4,5kW Finnisch	400V ~ 3N	4,5kW
4,5kW integreret Kontrolenhed	400V ~ 3N	4,5kW
3,6kW Bio	230V ~ 1N	3,6kW
3,6kW Finnisch	230V ~ 1N	3,6kW
3,6kW integreret Kontrolenhed	230V ~ 1N	3,6kW
<b>Kontrolenhed</b>		
Ekstern Easy Bio	400V ~ 3N	max. 10,8kW
Ekstern Plug&Play Bio	240V ~ 3N	max. 10,8kW
Ekstern Finnisch	400V ~ 3N	max. 10,8kW
Ekstern Plug&Play Finnisch	240V ~ 3N	max. 10,8kW
Multi-controller	400V ~ 3N	max. 10,5kW
Ekstern Classic Bio	400V ~ 3N	max. 9kW
Ekstern Classic Finnisch	400V ~ 3N	max. 9kW
Ekstern Premium Bio	400V ~ 3N	max. 12kW
Ekstern Premium Finnisch	400V ~ 3N	max. 9kW

## Datos técnicos

El tipo de horno o unidad de control adquirida figura en la confirmación del pedido o en el albarán de entrega. Consulte en la siguiente lista los datos técnicos de sus unidades.

	<b>Tensión de red</b>	<b>Vatios</b>
<b>Horno</b>		
9kW Bio	400V ~ 3N	9kW
9kW Finnisch	400V ~ 3N	9kW
9kW integrado Unidad de control	400V ~ 3N	9kW
4,5kW Bio	400V ~ 3N	4,5kW
4,5kW Finnisch	400V ~ 3N	4,5kW
4,5kW integrado Unidad de control	400V ~ 3N	4,5kW
3,6kW Bio	230V ~ 1N	3,6kW
3,6kW Finnisch	230V ~ 1N	3,6kW
3,6kW integrado Unidad de control	230V ~ 1N	3,6kW
<b>Unidad de control</b>		
Exterior Easy Bio	400V ~ 3N	max. 10,8kW
Exterior Plug&Play Bio	240V ~ 3N	max. 10,8kW
Exterior Finnisch	400V ~ 3N	max. 10,8kW
Exterior Plug&Play Finnisch	240V ~ 3N	max. 10,8kW
Mando múltiple	400V ~ 3N	max. 10,5kW
Exterior Classic Bio	400V ~ 3N	max. 9kW
Exterior Classic Finnisch	400V ~ 3N	max. 9kW
Exterior Premium Bio	400V ~ 3N	max. 12kW
Exterior Premium Finnisch	400V ~ 3N	max. 9kW

 **Dati tecnici**

Il tipo di forno o di unità di controllo acquistato è riportato nella conferma d'ordine o nella bolla di consegna. Per i dati tecnici delle unità, consultare il seguente elenco

	<b>Tensione di rete</b>	<b>Potenza</b>
<b>Forno</b>		
9kW Bio	400V ~ 3N	9kW
9kW Finnisch	400V ~ 3N	9kW
9kW integrato Unità di controllo	400V ~ 3N	9kW
4,5kW Bio	400V ~ 3N	4,5kW
4,5kW Finnisch	400V ~ 3N	4,5kW
4,5kW integrato Unità di controllo	400V ~ 3N	4,5kW
3,6kW Bio	230V ~ 1N	3,6kW
3,6kW Finnisch	230V ~ 1N	3,6kW
3,6kW integrato Unità di controllo	230V ~ 1N	3,6kW
<b>Unità di controllo</b>		
Esterno Easy Bio	400V ~ 3N	max. 10,8kW
Esterno Plug&Play Bio	240V ~ 3N	max. 10,8kW
Esterno Finnisch	400V ~ 3N	max. 10,8kW
Esterno Plug&Play Finnisch	240V ~ 3N	max. 10,8kW
Controllore multiplo	400V ~ 3N	max. 10,5kW
Esterno Classic Bio	400V ~ 3N	max. 9kW
Esterno Classic Finnisch	400V ~ 3N	max. 9kW
Esterno Premium Bio	400V ~ 3N	max. 12kW
Esterno Premium Finnisch	400V ~ 3N	max. 9kW

 **Technické údaje**

Typ zakoupené trouby nebo řídicí jednotky naleznete v potvrzení objednávky nebo v dodacím listu. Technické údaje vašich jednotek naleznete v následujícím seznamu

	<b>Síťové napětí</b>	<b>Příkon</b>
<b>Trouba</b>		
9kW Bio	400V ~ 3N	9kW
9kW Finnisch	400V ~ 3N	9kW
9kW integrovaný Řídicí jednotka	400V ~ 3N	9kW
4,5kW Bio	400V ~ 3N	4,5kW
4,5kW Finnisch	400V ~ 3N	4,5kW
4,5kW integrovaný Řídicí jednotka	400V ~ 3N	4,5kW
3,6kW Bio	230V ~ 1N	3,6kW
3,6kW Finnisch	230V ~ 1N	3,6kW
3,6kW integrovaný Řídicí jednotka	230V ~ 1N	3,6kW
<b>Řídicí jednotka</b>		
Externí Easy Bio	400V ~ 3N	max. 10,8kW
Externí Plug&Play Bio	240V ~ 3N	max. 10,8kW
Externí Finnisch	400V ~ 3N	max. 10,8kW
Externí Plug&Play Finnisch	240V ~ 3N	max. 10,8kW
Multi-controller	400V ~ 3N	max. 10,5kW
Externí Classic Bio	400V ~ 3N	max. 9kW
Externí Classic Finnisch	400V ~ 3N	max. 9kW
Externí Premium Bio	400V ~ 3N	max. 12kW
Externí Premium Finnisch	400V ~ 3N	max. 9kW

 **Tehnični podatki**

Vrsta kupljene pečice ali krmilne enote je navedena v potrditvi naročila ali dobavnici. Tehnične podatke vaših enot najdete na naslednjem seznamu

	<b>Omrežna napetost</b>	<b>Moč</b>
<b>Pečica</b>		
9kW Bio	400V ~ 3N	9kW
9kW Finnisch	400V ~ 3N	9kW
9kW integriran Nadzorna enota	400V ~ 3N	9kW
4,5kW Bio	400V ~ 3N	4,5kW
4,5kW Finnisch	400V ~ 3N	4,5kW
4,5kW integriran Nadzorna enota	400V ~ 3N	4,5kW
3,6kW Bio	230V ~ 1N	3,6kW
3,6kW Finnisch	230V ~ 1N	3,6kW
3,6kW integriran Nadzorna enota	230V ~ 1N	3,6kW
<b>Nadzorna enota</b>		
Zunanja stran Easy Bio	400V ~ 3N	max. 10,8kW
Zunanja stran Plug&Play Bio	240V ~ 3N	max. 10,8kW
Zunanja stran Finnisch	400V ~ 3N	max. 10,8kW
Zunanja stran Plug&Play Finnisch	240V ~ 3N	max. 10,8kW
Več krmilnikov	400V ~ 3N	max. 10,5kW
Zunanja stran Classic Bio	400V ~ 3N	max. 9kW
Zunanja stran Classic Finnisch	400V ~ 3N	max. 9kW
Zunanja stran Premium Bio	400V ~ 3N	max. 12kW
Zunanja stran Premium Finnisch	400V ~ 3N	max. 9kW





Bitte bewahren Sie die Anleitung und den Garantieschein zur Seriennummer auf.





Vernichten Sie diese erst nach Ablauf der Garantiezeit.





Eventuelle Beanstandungen können mithilfe der Stückliste einfacher zugeordnet werden.





#### Beigelegte Dokumente

- Informationsheft
- Garantieschein zur Seriennummer
- Typenschild inkl. Warnhinweise (Sauna)
- ggf. Zubehör-Anleitungen in externen Paketen





- \*  Nicht im Lieferumfang enthalten  
 Not included  
 Non comprises dans la livraison  
 Niet bijgeleverd

-  No forman parte del suministro  
 Non incluso  
 V ceně není zahrnuto  
 Ikke inkluderet  
 Ni včlučeno v obseg dobave

- 1  Länge muss ermittelt und zugesägt werden  
 Length must be determined and sawn  
 La longueur doit être déterminée et sciée  
 De lengte moet worden bepaald en worden gezaagd

-  La longitud debe ser determinada y aserrada  
 La lunghezza deve essere determinata e segata  
 Délka musí být určena a rozřezána  
 Længden skal bestemmes og saves  
 Določiti je treba dolžino in jo odrezati po velikosti.





- 2  Nicht gebraucht  
 Not needed  
 Pas nécessaire  
 Niet nodig

-  No es necesario  
 Non necessario  
 Není nutná  
 Ikke nødvendig  
 Ne uporabljaja se

- 3  Mit Zubehör  
 With accessories  
 Avec accessoires  
 Met toebehoren

-  Con accesorios  
 Con accessori  
 S příslušenstvím  
 Med tilbehør  
 Z dodatki

- 4  Fixiert vorübergehend  
 Fixed temporarily  
 Temporairement fixe  
 Tijdelijk vast

-  Temporalmente fijo  
 Temporaneamente fisso  
 Dočasně pevný  
 Midlertidigt rettet  
 Začasno popravi

- 5  Bestand vom Haus  
 Inventory of the house  
 Inventaire de la maison  
 Inventaris von het huis

-  Inventario de la casa  
 Inventario della casa  
 Inventář domu  
 Inventar af huset  
 Inventarizacija hiše

 Vergleichen Sie zuerst die Material-liste mit Ihrem Paketinhalt! Bitte haben Sie Verständnis, dass Beanstandungen nur im nicht aufgebauten Zustand bearbeitet werden können!

 First compare the list of materials with your package contents! Please understand that complaints can be processed in the non-built status only!

 Commencez par comparer la liste du matériel avec le contenu de votre paquet! Sachez que nous traitons uniquement les réclamations concernant le matériel à l'état non monté!

 Vergelijk eerst de lijst van materialen met de inhoud van uw pakket! Reclamaties kunnen alleen in behandeling worden genomen zolang de onderdelen nog niet zijn gemonteerd!

 Start med at kontrollere materialelisten med indholdet af den leverede pakke! Vi gør venligst opmærksom på at reklamationer kun kan behandles for materialer som ikke er blevet bearbejdet!



 En primer lugar, compare la lista de material con el contenido del paquete. Rogamos entienda que las reclamaciones sólo pueden ser tramitadas antes de montar el objeto!

 Confrontate questa distinta materiali prima con il contenuto del pacchetto! Vi preghiamo di comprendere che eventuali reclami possono essere accolti solo prima del montaggio!

 Nejprve přezkontrolujte obsah balení podle materiálového listu! Mějte pochopení pro to, že případnou reklamaci se můžeme zabývat pouze tehdy, když díly nebudou smontované! Za pomoci tohoto seznamu můžete jednotlivé díly přiřadit k montážnímu návodu.



 Najprej primerajte zoznam materialov z vsebino vašega paketa! Upoštevajte, da lahko pritožbe obravnavamo le v neseštvljenem stanju!



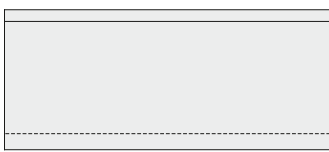

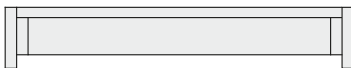
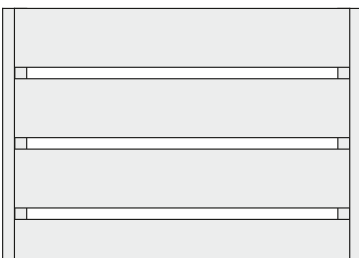
		
12x <b>B1</b>	2380 x 6,5 x 16 mm	ID 92932
4 x <b>B2</b>	750 x 36 x 12 mm	ID 24239
4 x <b>B3</b>	1920 x 36 x 12 mm	ID 24846
2 x <b>B4</b>	1260 x 90 x 16 mm	ID 8218
1 x <b>B5</b>	1810 x 90 x 16 mm	ID 71513
9 x <b>B6</b>	2100 x 45 x 18 mm	ID 19547
4 x <b>B7</b>	480 x 95 x 18 mm	ID 20930
4 x <b>B8</b>	595 x 95 x 18 mm	ID 25456
2 x <b>B9</b>	2042 x 95 x 18 mm	ID 85145
4 x <b>B10</b>	2386 x 78 x 18 mm	ID 85228
1 x <b>B11</b>	300 x 120 x 18 mm	ID 22467
18 x <b>B12</b>	1920 x 3,2 x 19 mm	ID 20799
11 x <b>B13</b>	2042 x 140 x 26 mm	ID 93645
6 x <b>B14</b>	2039 x 42 x 28 mm	ID 93644
2 x <b>B15</b>	3900 x 42 x 28 mm	ID 23481
2 x <b>B16</b>	2000 x 53 x 28 mm	ID 93647
6 x <b>B17</b>	380 x 35 x 35 mm	ID 92726
6 x <b>B18</b>	1110 x 35 x 35 mm	ID 92725
2 x <b>B19</b>	509 x 45 x 38 mm	ID 93649

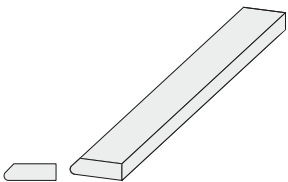

		
25 x <b>R1</b>	3577 x 96 x 16 mm	ID 93634
24 x <b>R2</b>	4200 x 96 x 16 mm	ID 71213

		
2 x <b>L1</b>	1260 x 550 x 95 mm	ID 52062
1 x <b>L2</b>	2010 x 550 x 95 mm	ID 80901

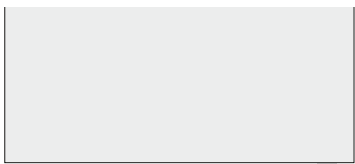
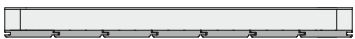

		
2 x <b>H1</b>	595 x 550 x 95 mm	ID 62922
1 x <b>H2</b>	895 x 550 x 95 mm	ID 16811

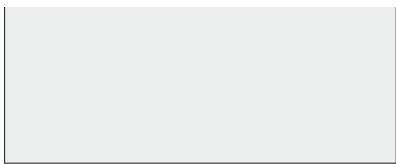
		
1 x <b>M1</b>	400 x 95 x 18 mm	ID 93654

		
1 x <b>N1</b>	2031 x 606 x 57 mm	ID 93666

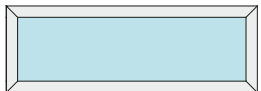
		
2 x <b>N2</b>	2031 x 710 x 57 mm	ID 93665

		
3 x <b>F1</b>	1220 x 420 x 40 mm	ID 92721

		
<b>KDI</b>		
6 x <b>K1</b>	2150 x 95 x 18 mm	ID 93643
3 x <b>K2</b>	598 x 60 x 40 mm	ID 93633
7 x <b>K3</b>	1990 x 60 x 40 mm	ID 15501
2 x <b>K4</b>	2150 x 60 x 80 mm	ID 93630
2 x <b>K5</b>	4095 x 60 x 80 mm	ID 93632



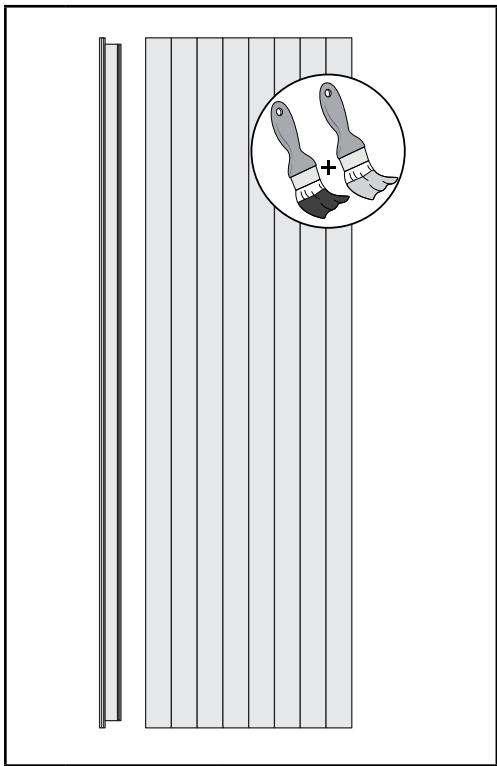

7 x C1 | 2380 x 709 x 73 mm | ID 83959

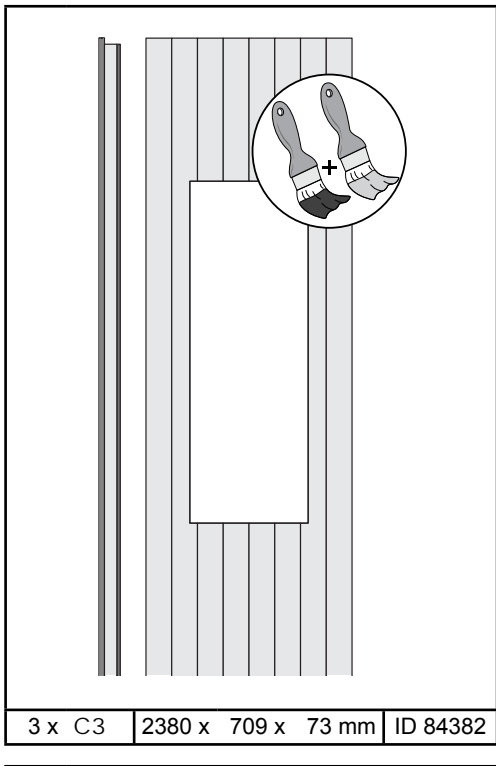

3 x C3 | 2380 x 709 x 73 mm | ID 84382

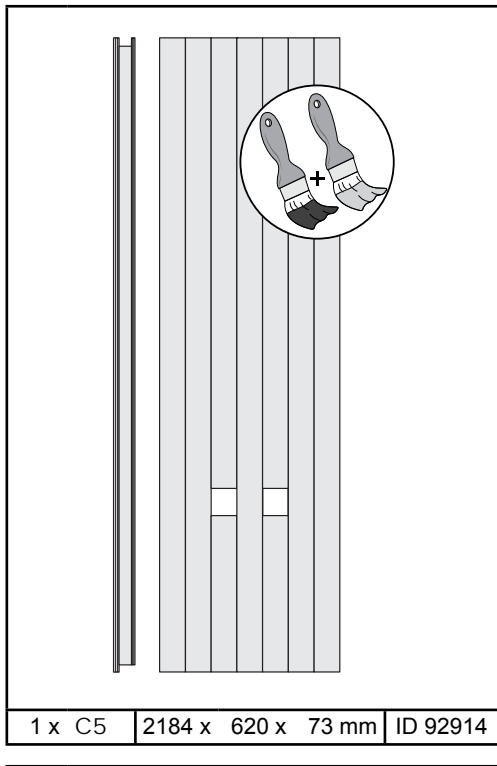

1 x C5 | 2184 x 620 x 73 mm | ID 92914

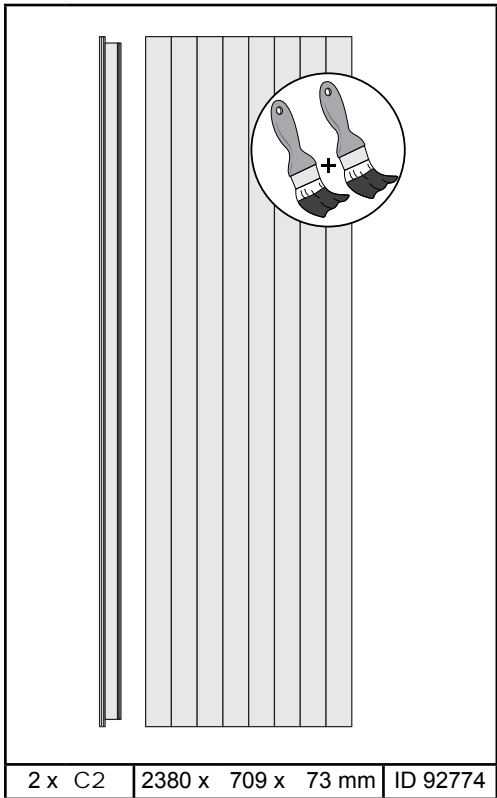

2 x C2 | 2380 x 709 x 73 mm | ID 92774

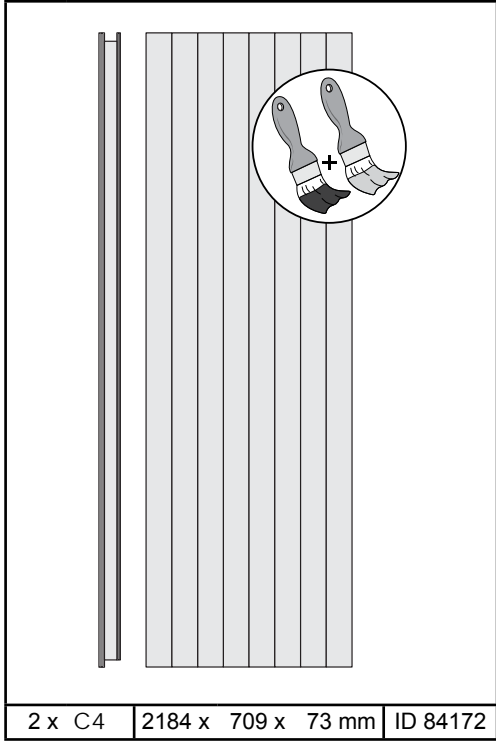

2 x C4 | 2184 x 709 x 73 mm | ID 84172

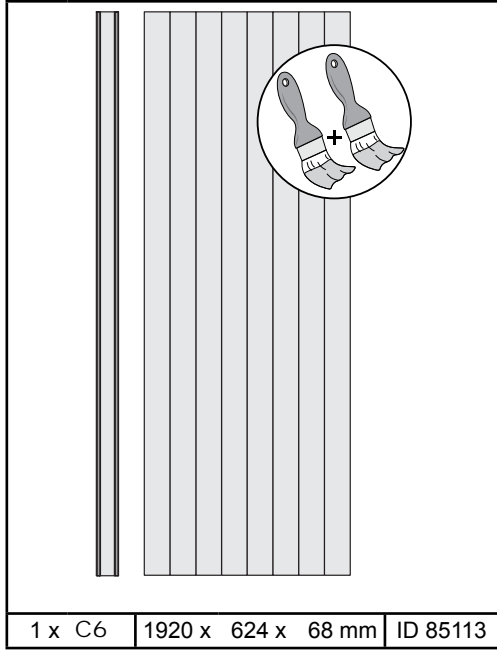

1 x C6 | 1920 x 624 x 68 mm | ID 85113

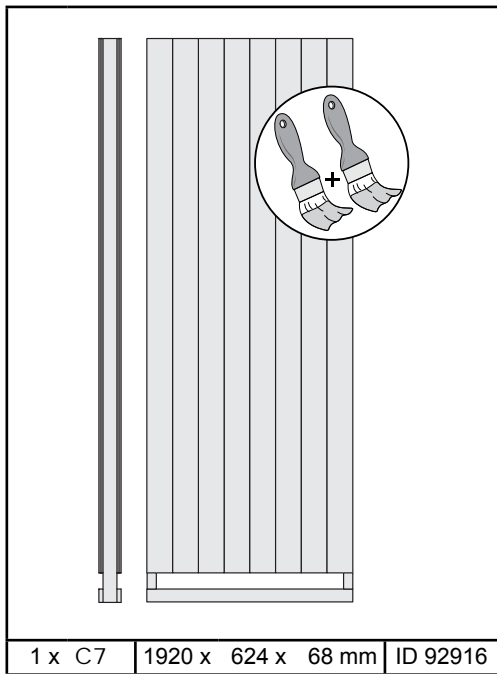

1 x C7 | 1920 x 624 x 68 mm | ID 92916

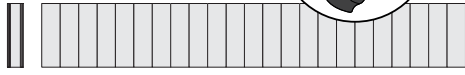
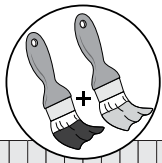

1 x C8 | 308 x 2042 x 68 mm | ID 84537

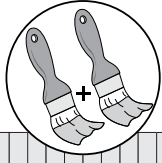

1 x C9 | 308 x 2042 x 68 mm | ID 84505

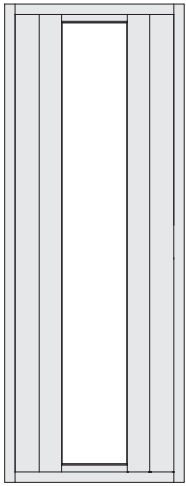

1 x | ID 64238

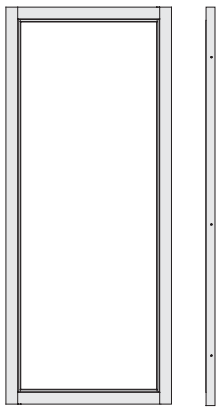

1 x X1 | ID 70241



1 x | ID 26114

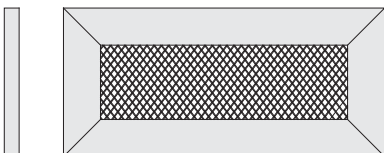

1 x | ID 93650

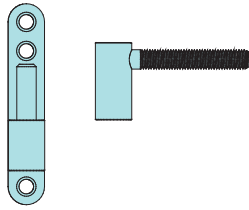

3 x | ID 3717

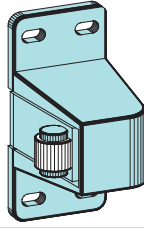

1 x | ID 64245

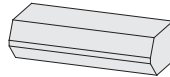

1 x | 28 x 42 x 100mm | ID 64800

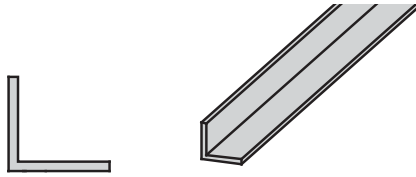

10 x M1 | 1228 x 30 x 30 mm | ID 79609

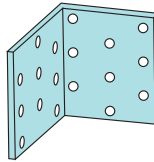

6 x | ID 14041

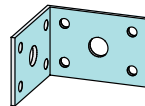

2 x | ID 21292

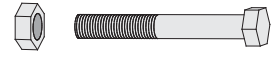

3 x | 8 x 70 mm | ID 14018



860 x | 2,2 x 50 mm | ID 5621

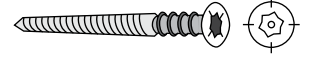

6 x S1 | 6 x 80 mm | ID 14266

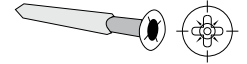

55 x | 4,5 x 50 mm | ID 27179

5 x | 4,5 x 70 mm | ID 27178



60 x S2 | 4,5 x 30 mm | ID 26116

6 x S2 | 12 x 18 mm | ID 46403

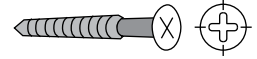

35 x | 4 x 30 mm | ID 3686

60 x | 4 x 35 mm | ID 3687

15 x | 4 x 40 mm | ID 21925

105 x | 4 x 50 mm | ID 3688

25 x | 4 x 60 mm | ID 21207

115 x | 4 x 70 mm | ID 3689

5 x | 6 x 60 mm | ID 14014

5 x | 6 x 80 mm | ID 47558

55 x | 6 x 120 mm | ID 9205

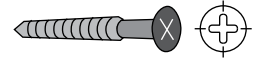

170 x | 4 x 50 mm | ID 93698

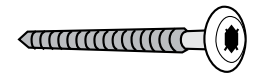

95 x | 8 x 100mm | ID 93697



1 x | ID 50420

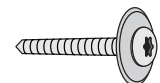

35 x | 4 x 40mm | ID 36178

51565

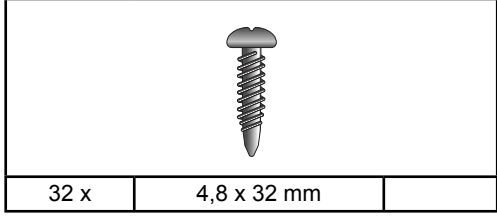
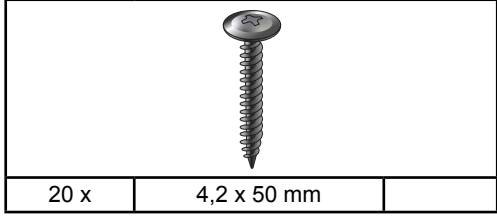
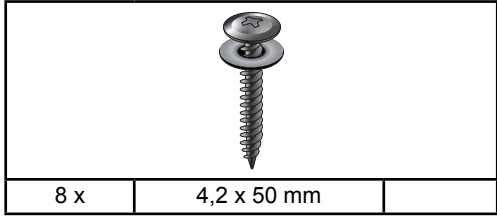
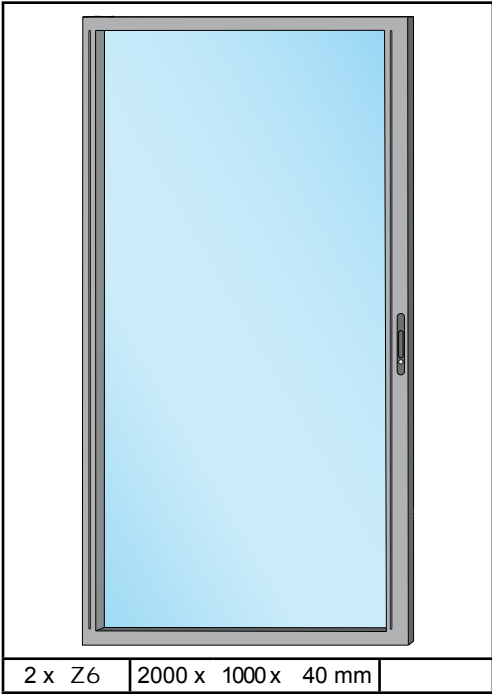
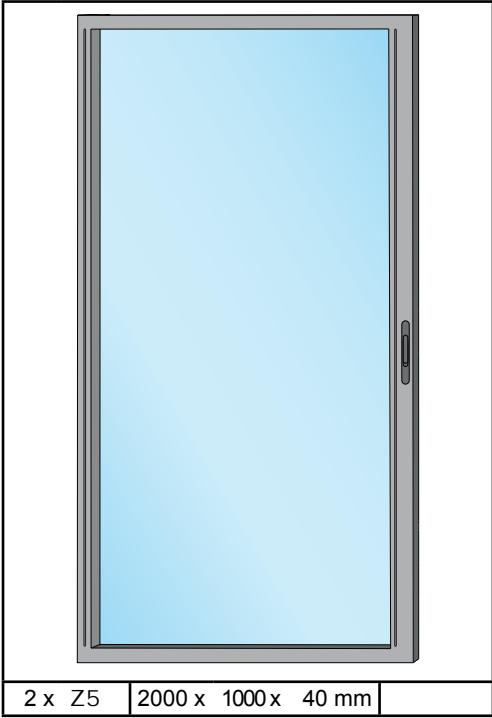
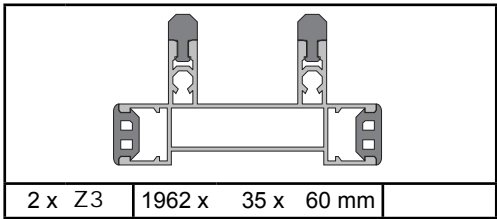
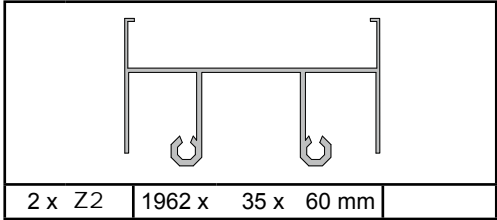
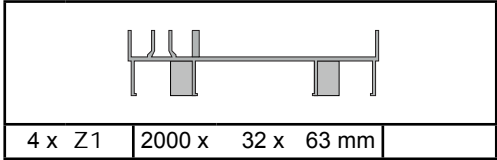

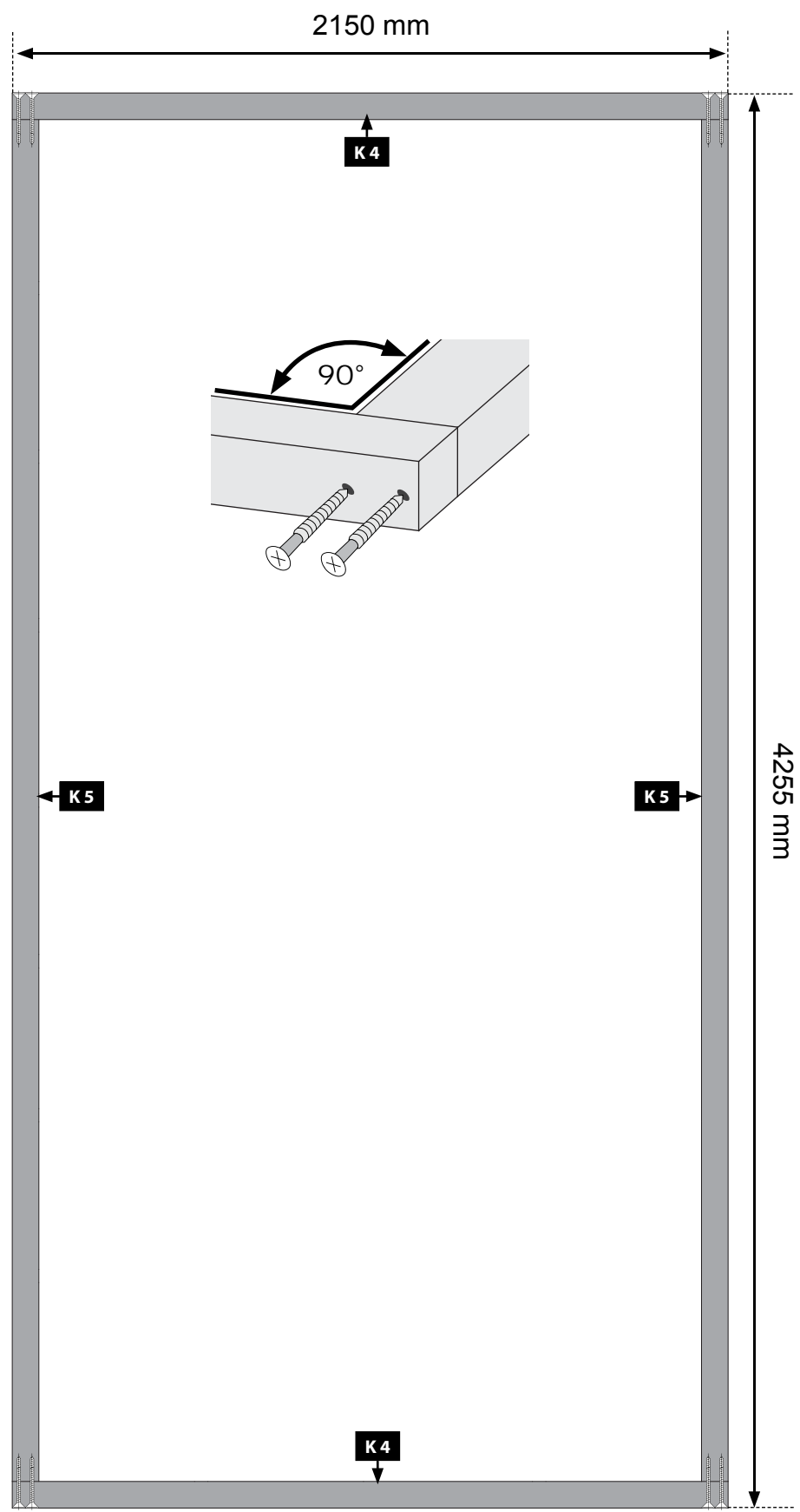
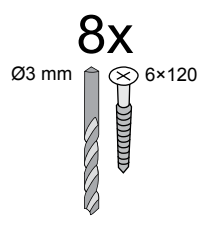
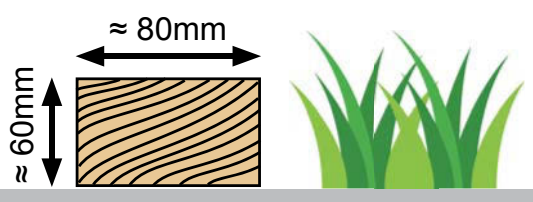



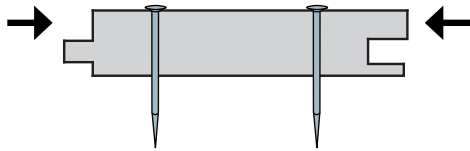



 Breite Seite nach oben

 Bred side opad

 Larghezza verso l'alto

 Width side up

 Breedte side up

 Šířka stranou nahoru

 Largeur vers le haut

 Ancho de banda de hasta

 Široka stran navzgor

03

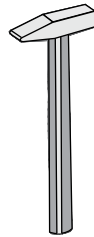

~452x

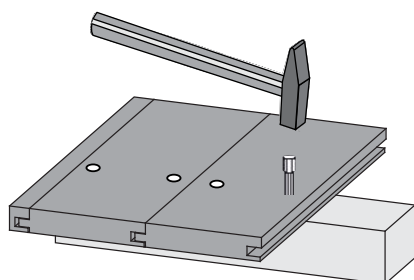
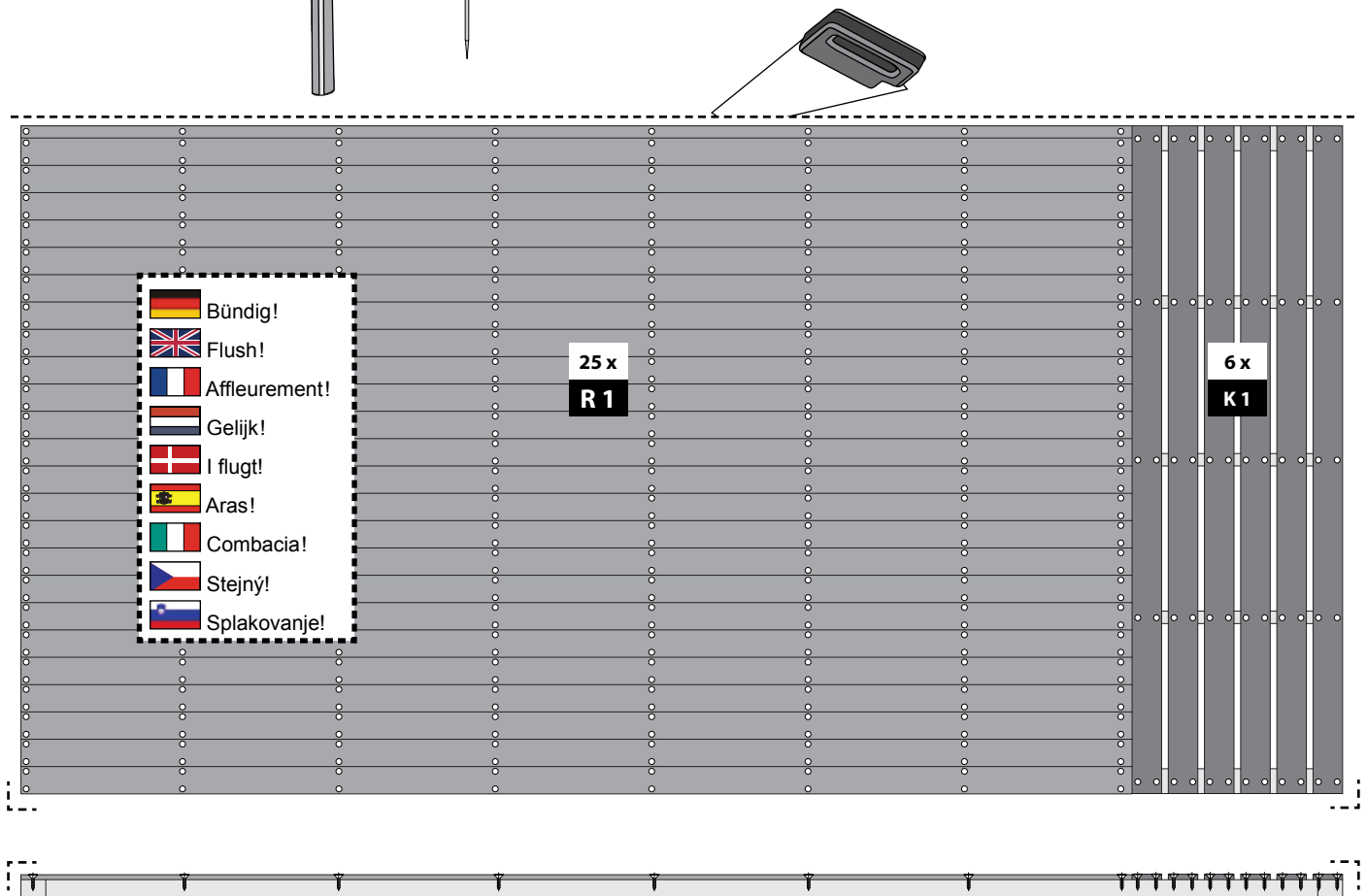
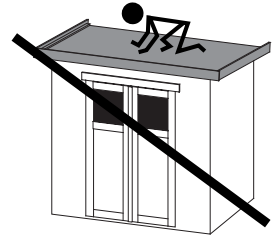
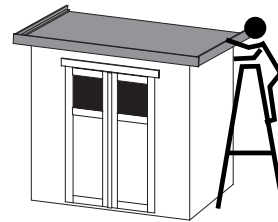

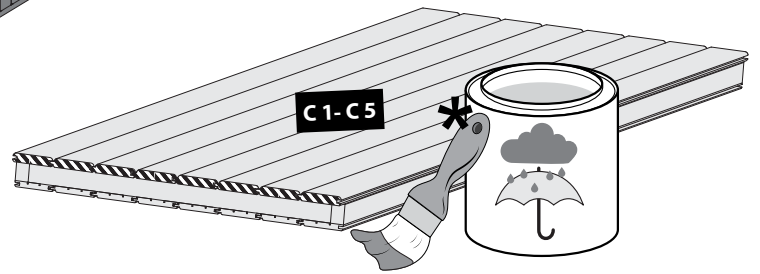
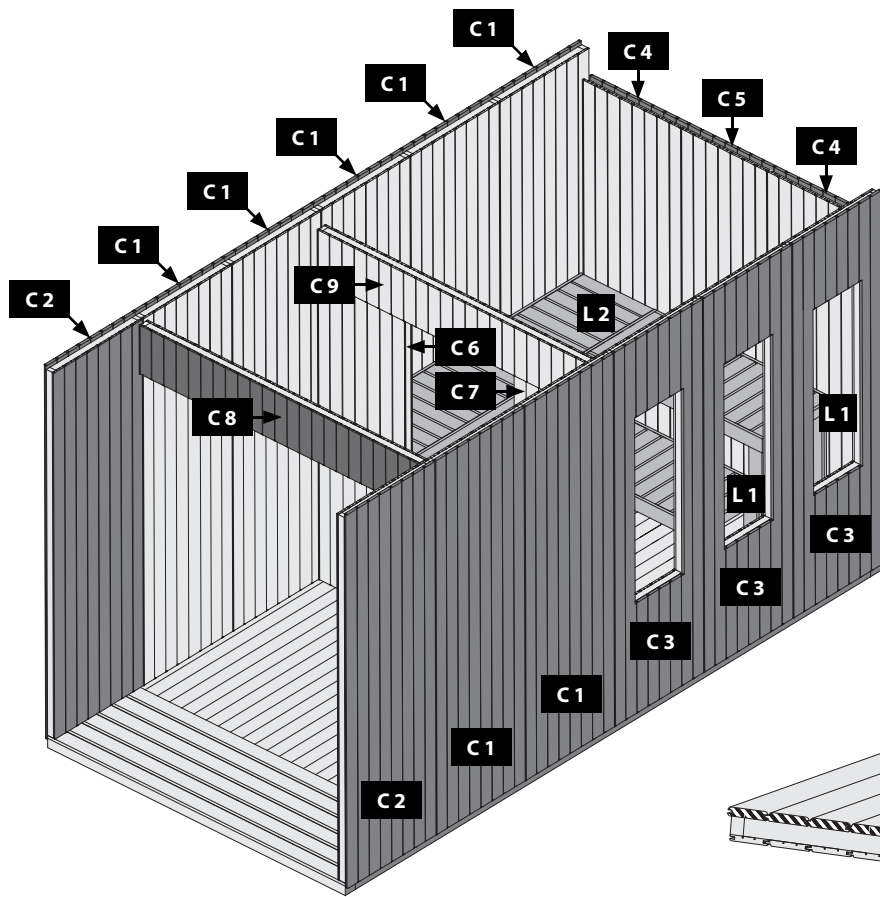

04

Ø7 mm  
6x  
8x100

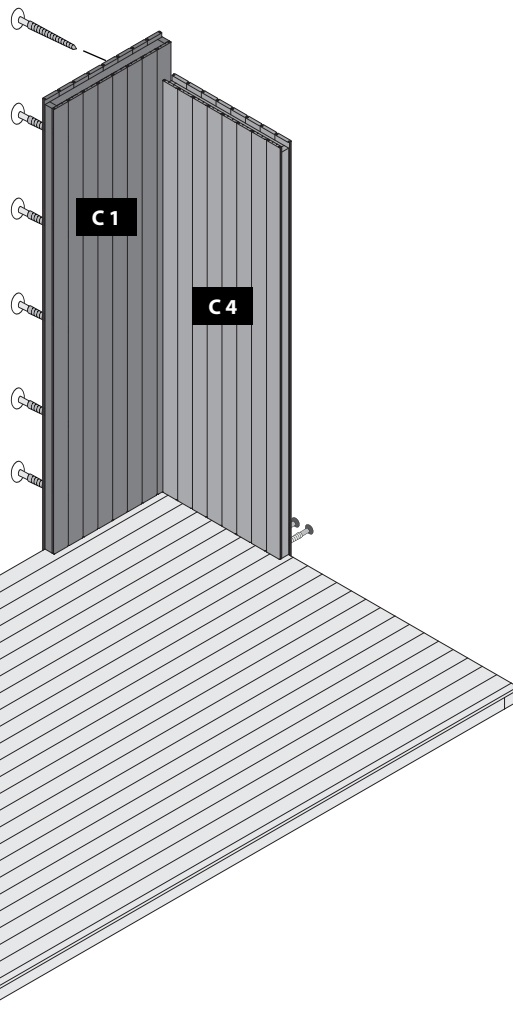

Ø3mm  
16x  
4x50

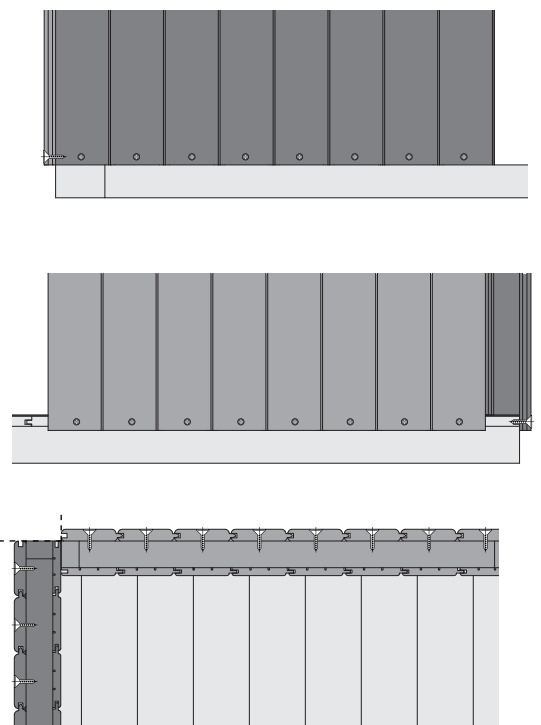

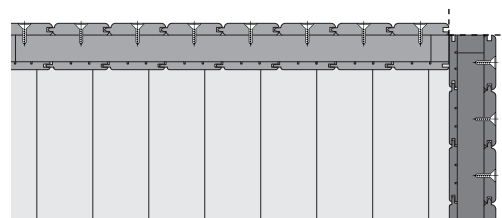
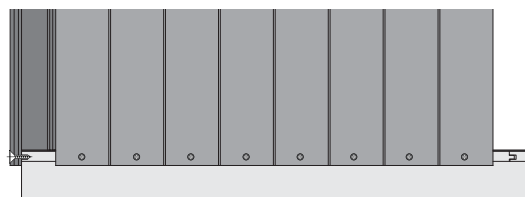
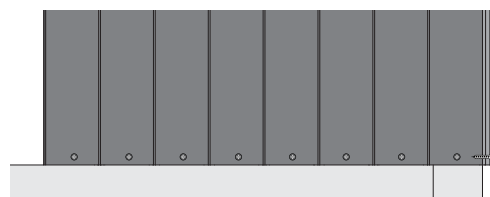
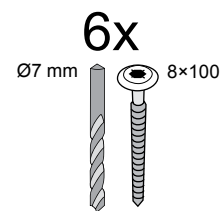
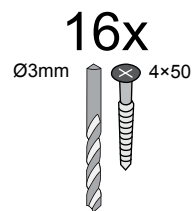
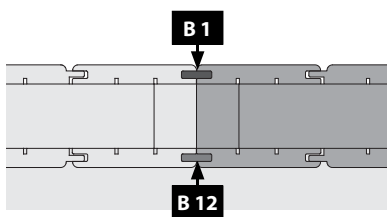
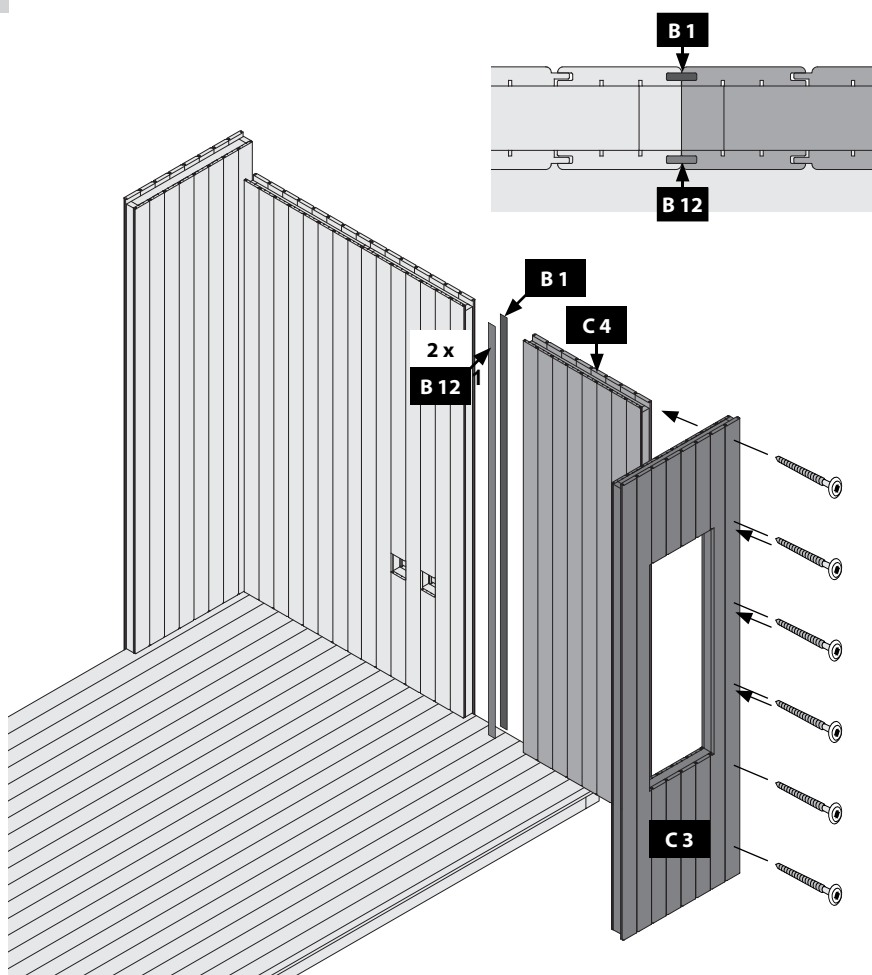
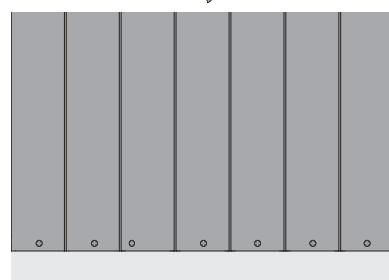
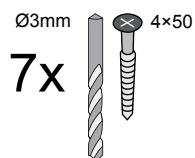
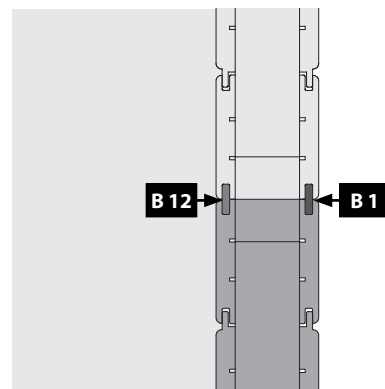
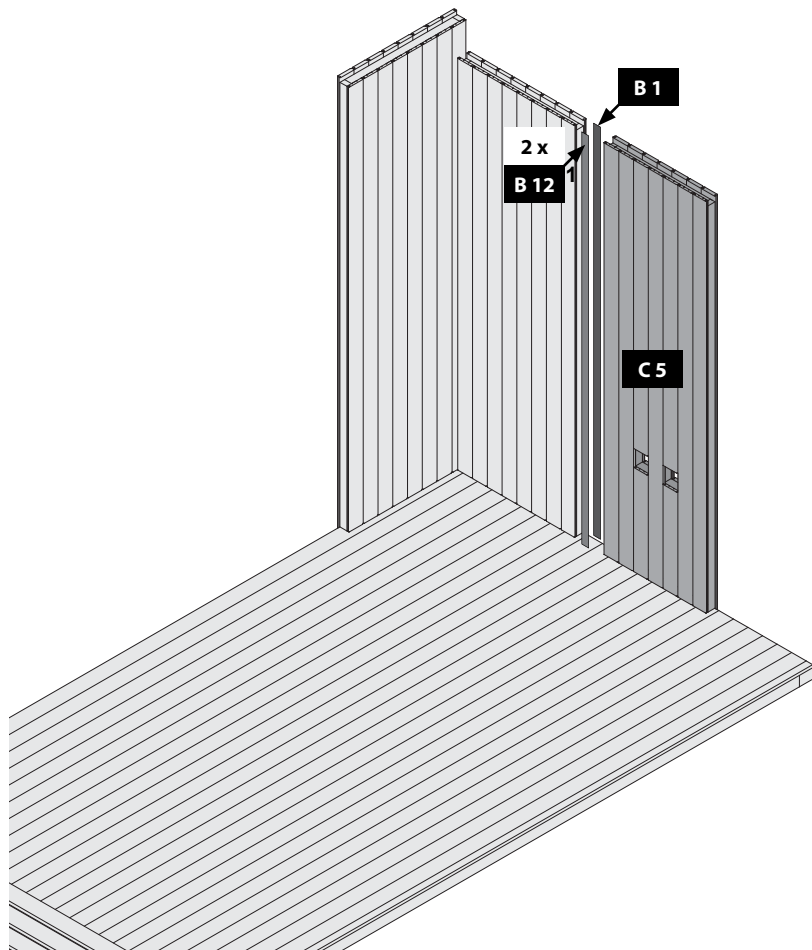



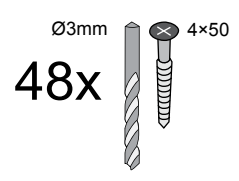
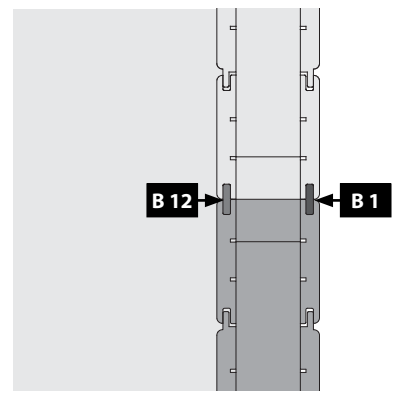
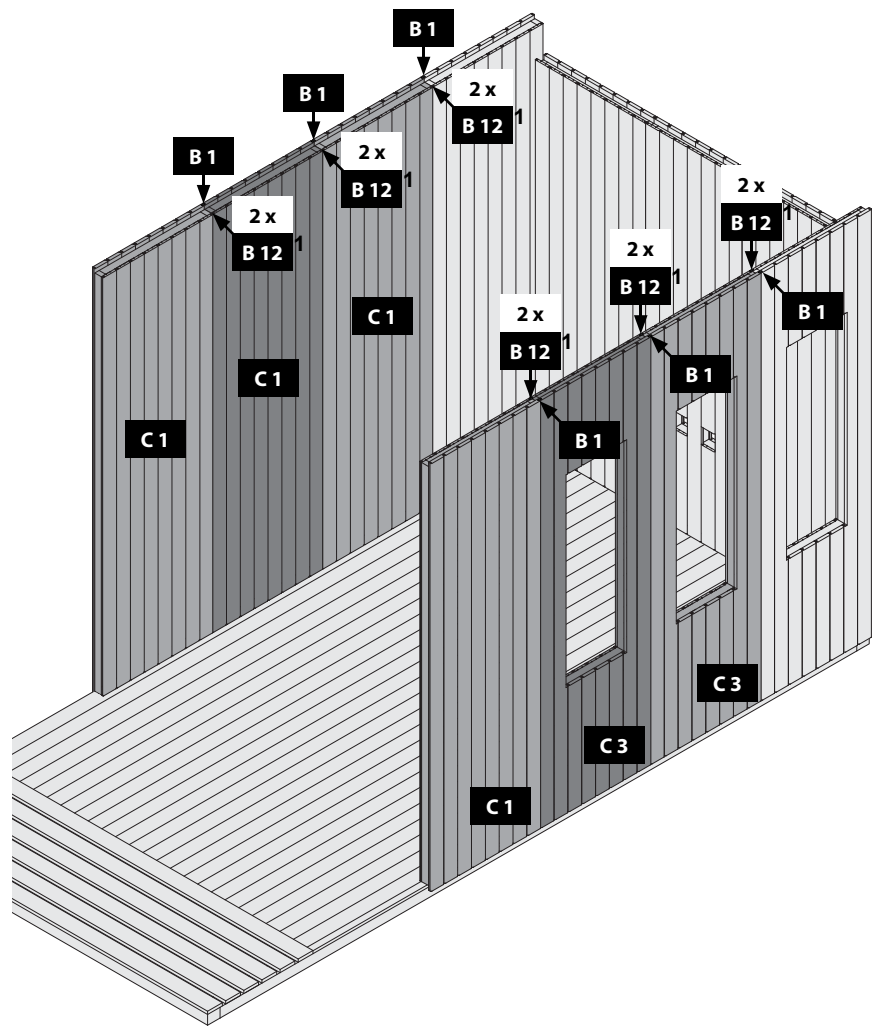

48x

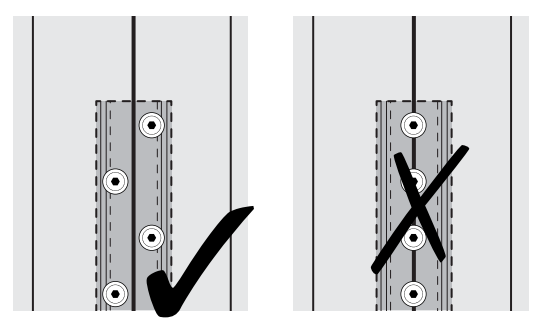
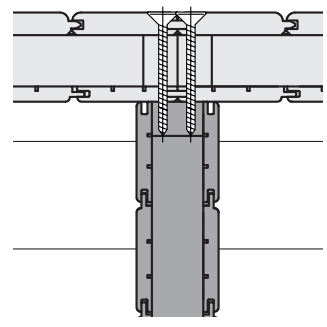
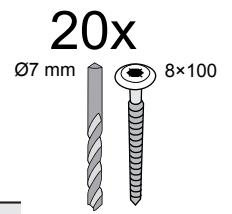
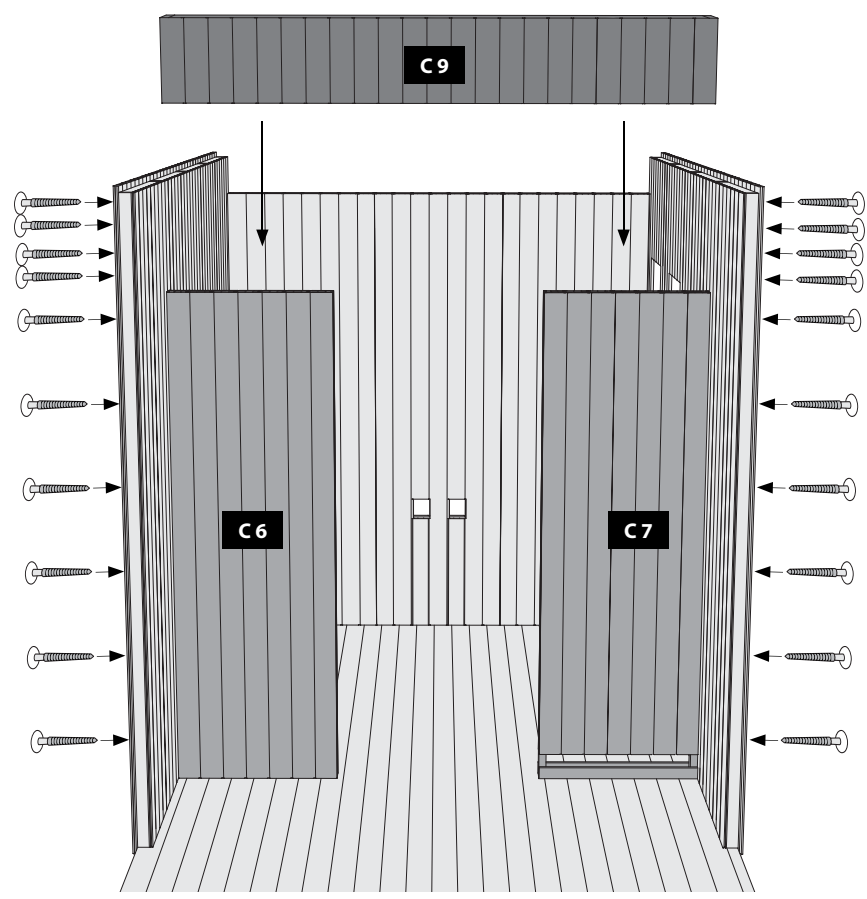
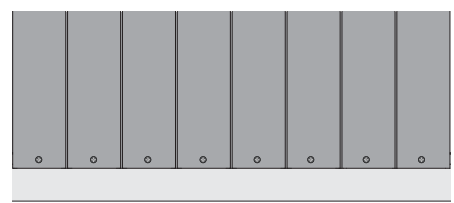

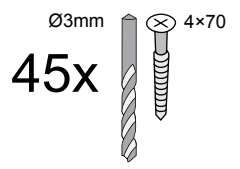
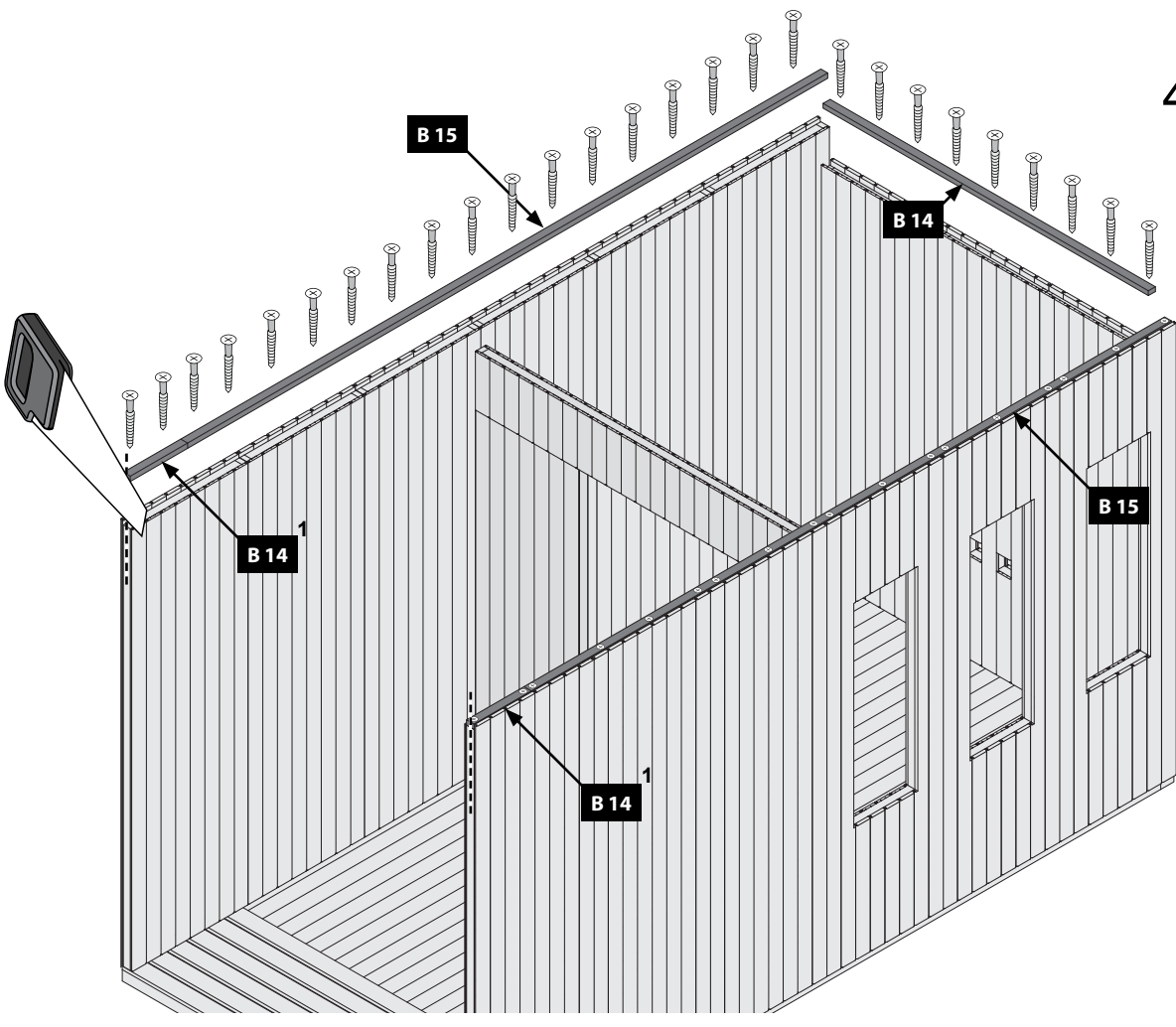
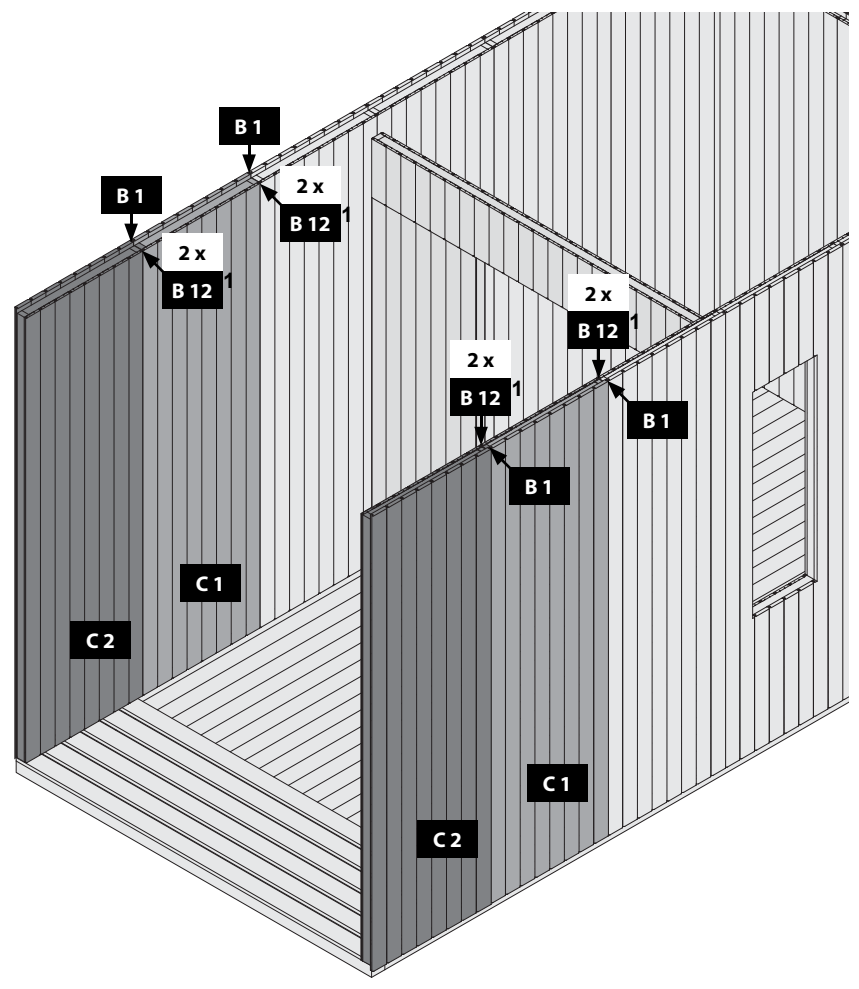
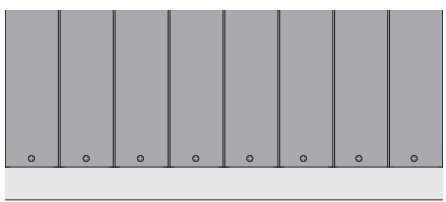
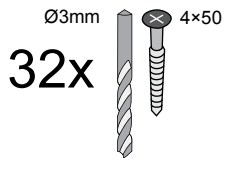
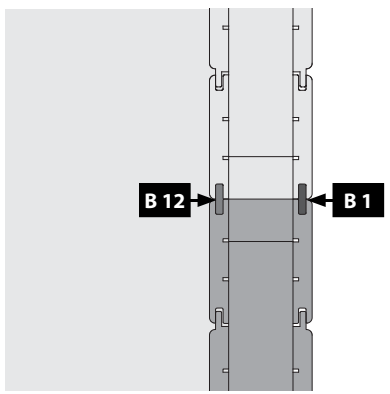

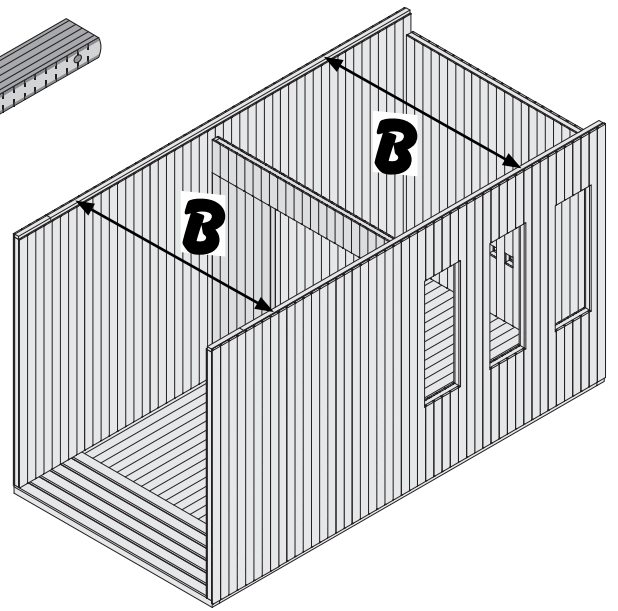
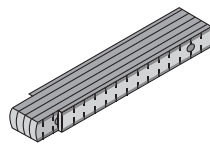
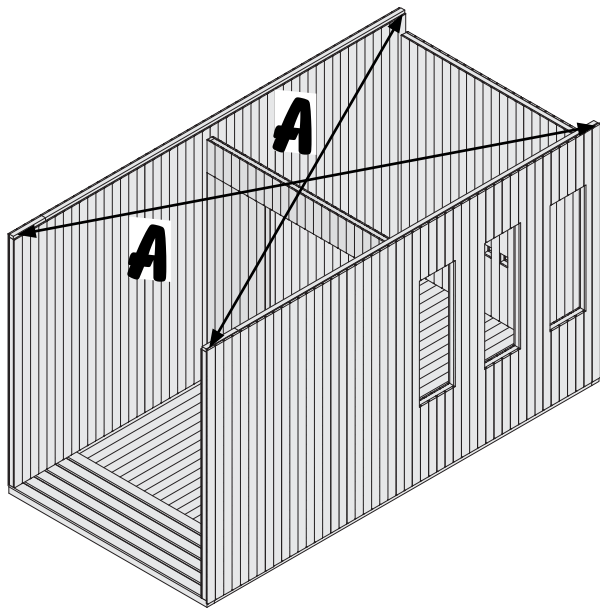

11

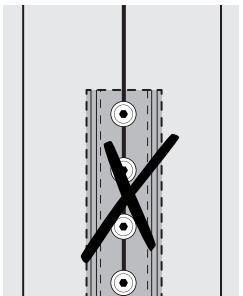
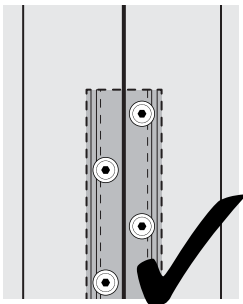
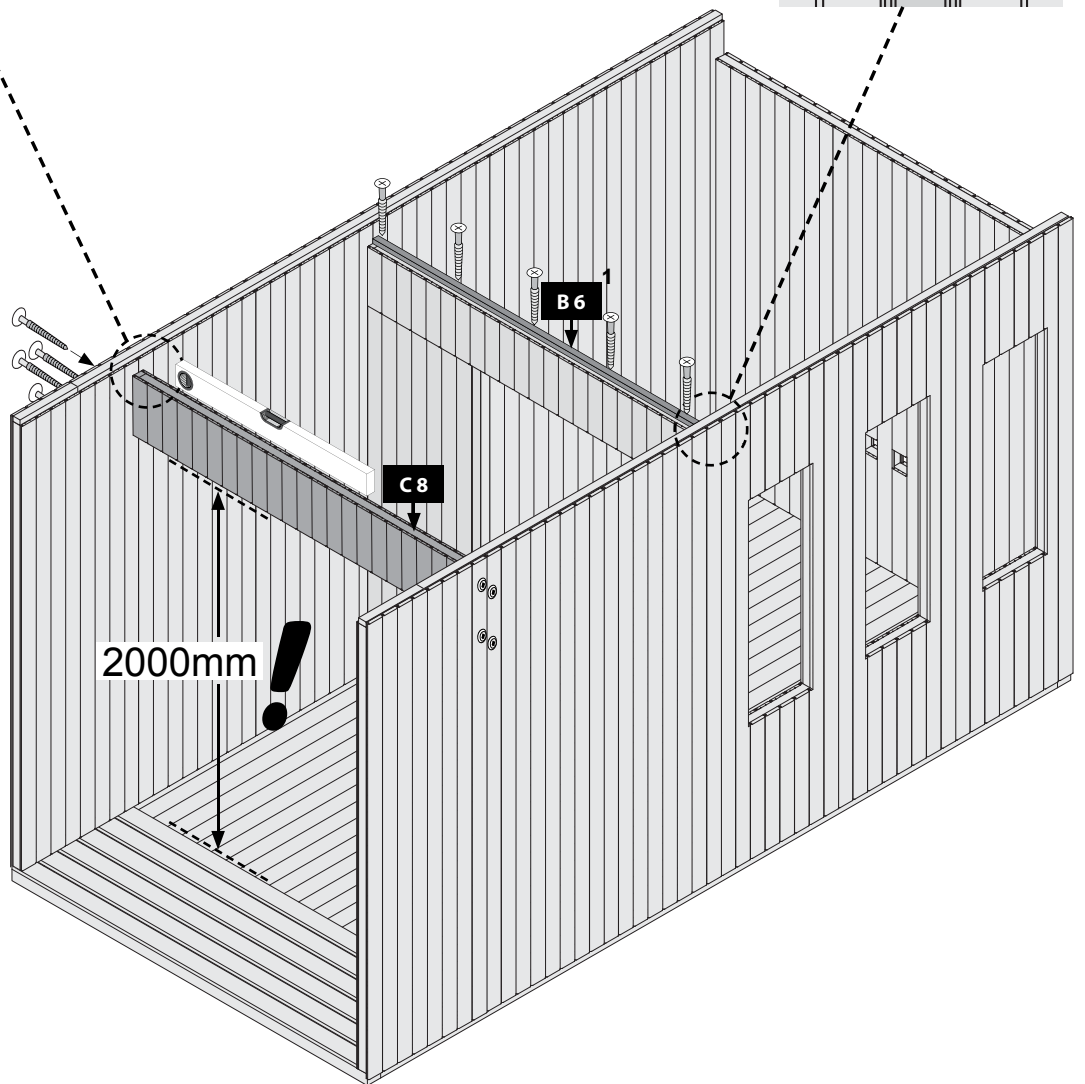
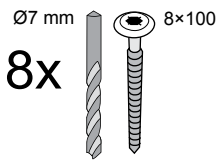
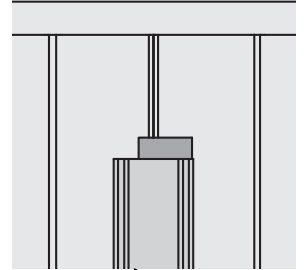
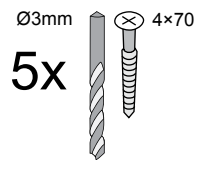
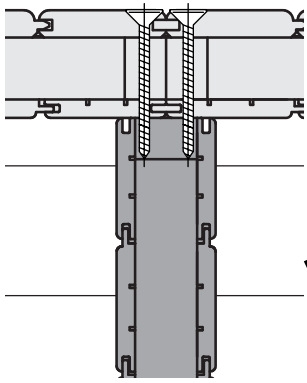

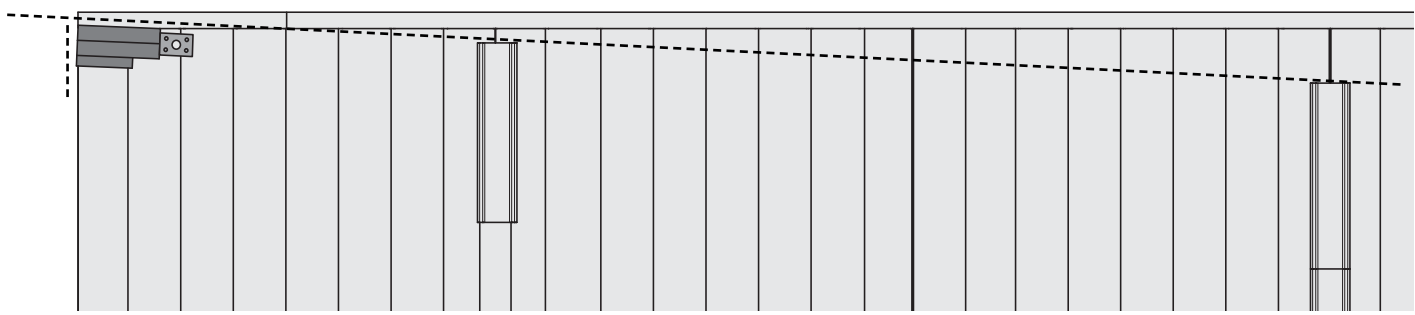
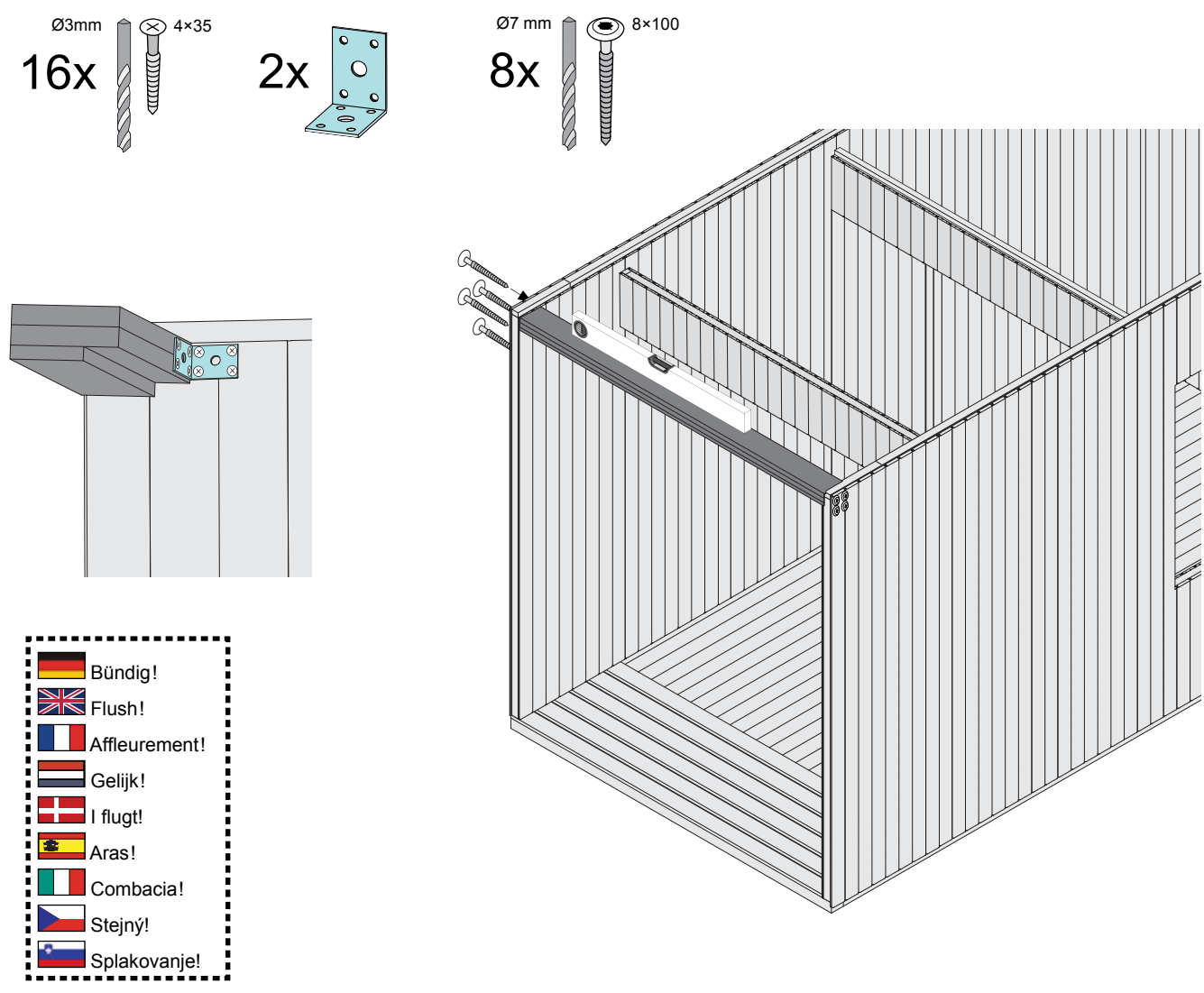
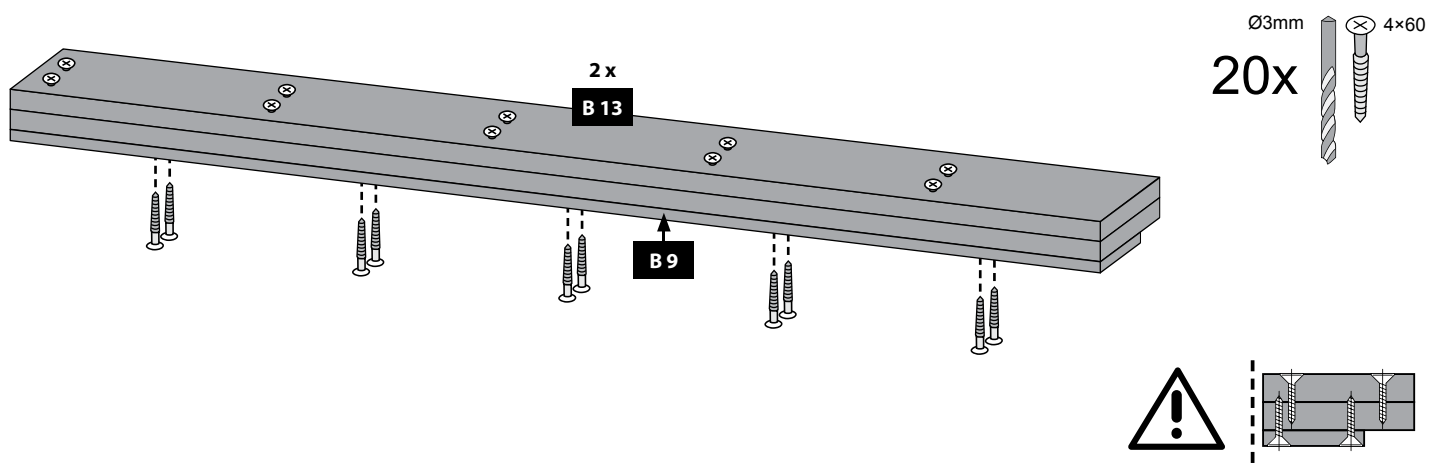

14

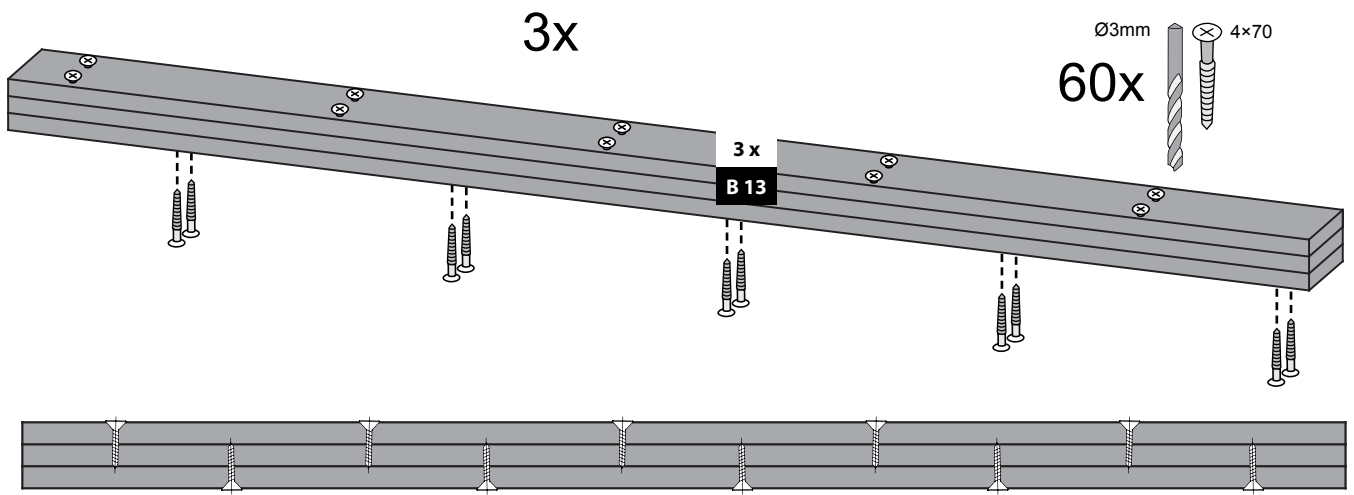

15

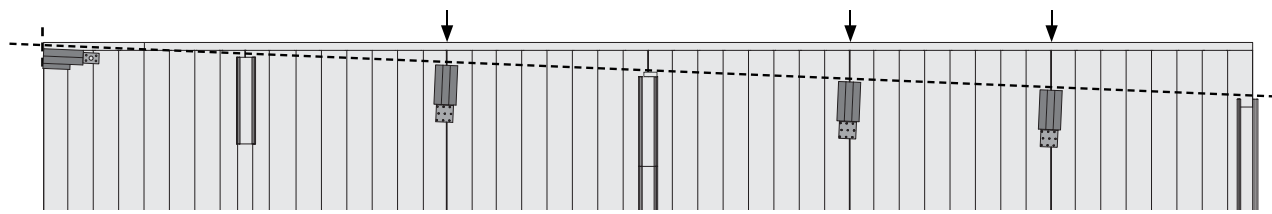
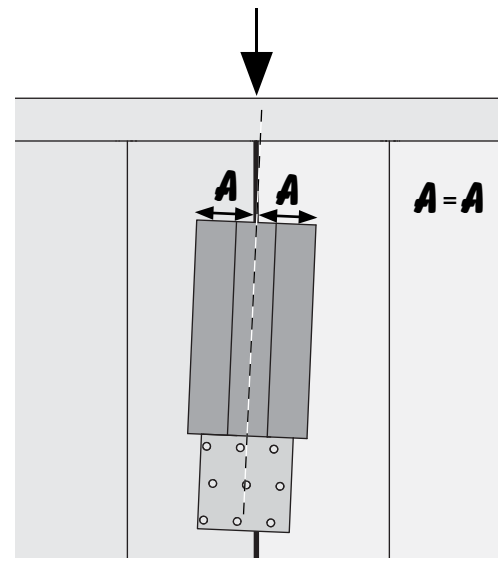
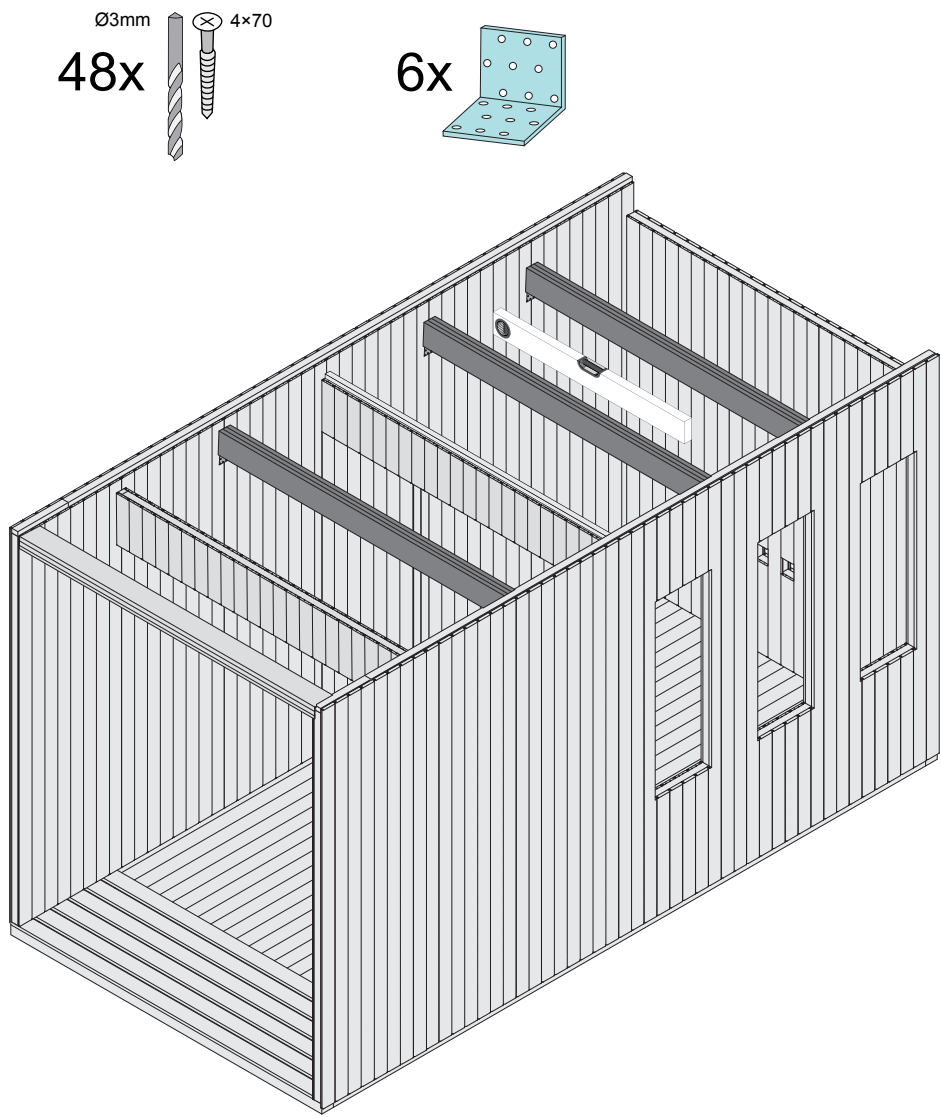

-  Bündig!
-  Flush!
-  Affleurement!
-  Gelijk!
-  I flugt!
-  Aras!
-  Combacia!
-  Stejný!
-  Splakovanie!

Ø3mm  
18x  
4x50

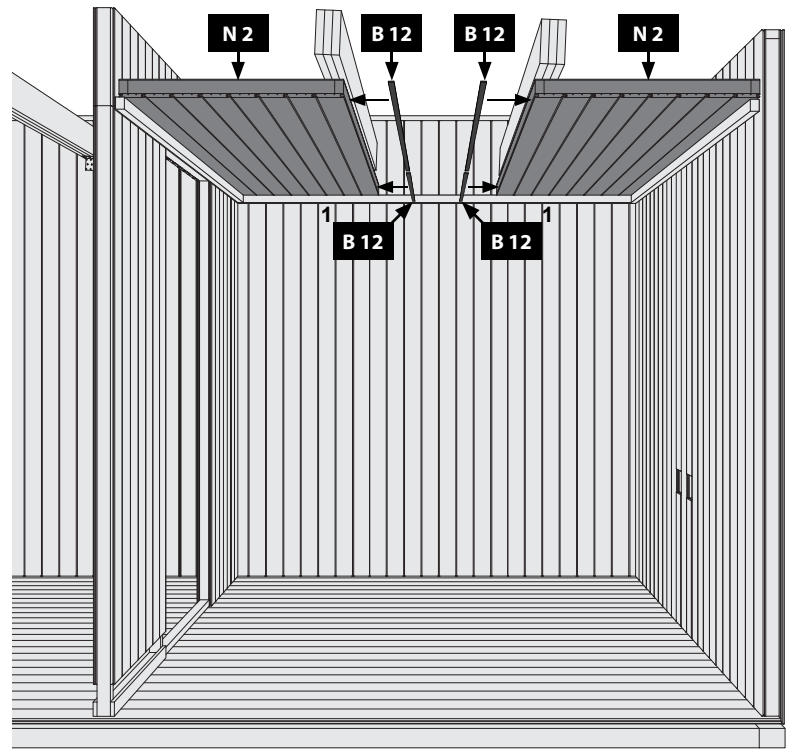
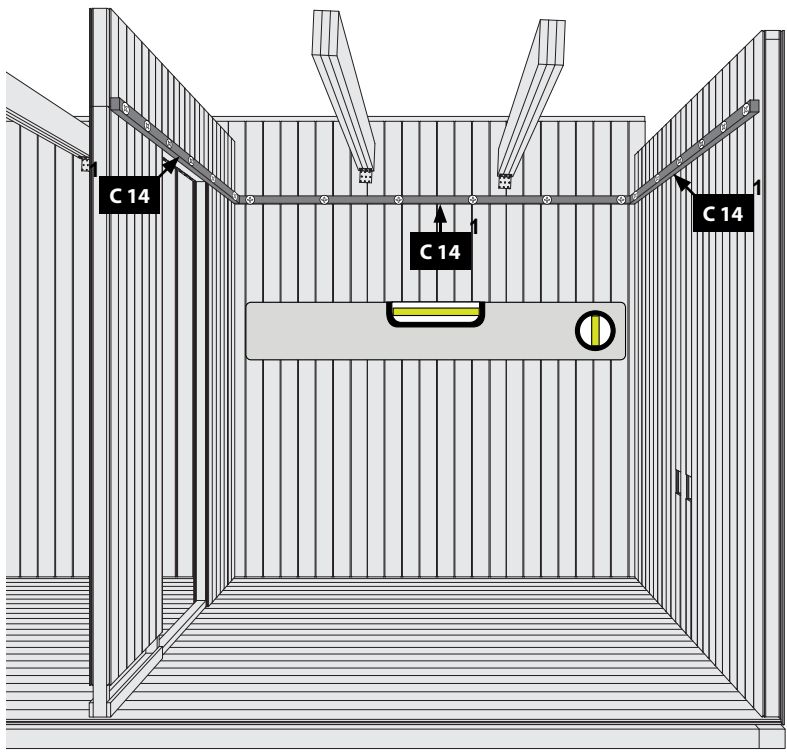
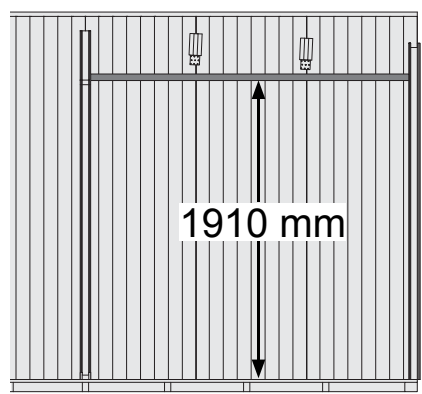

Ø3mm  
18x  
4x50

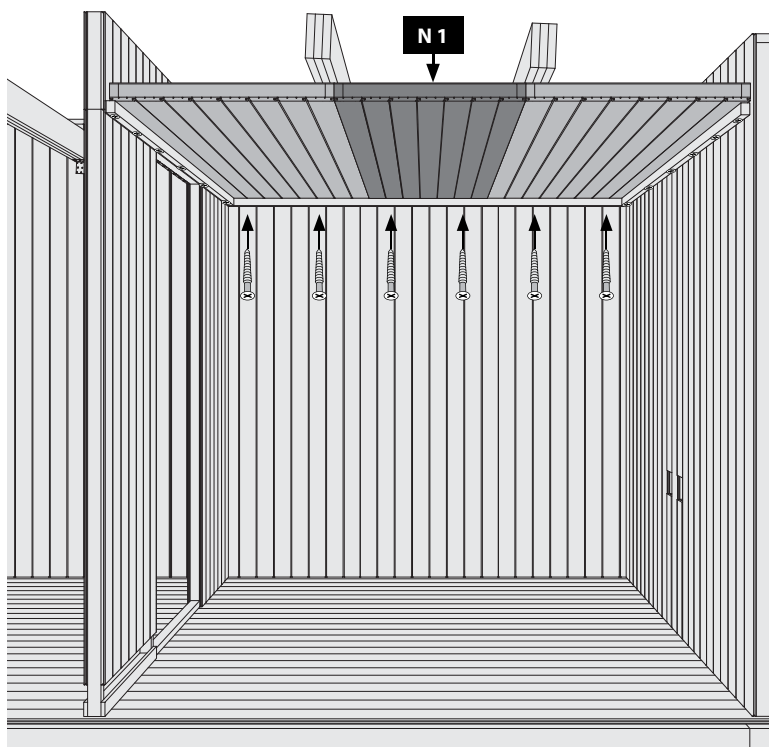
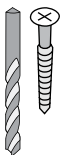

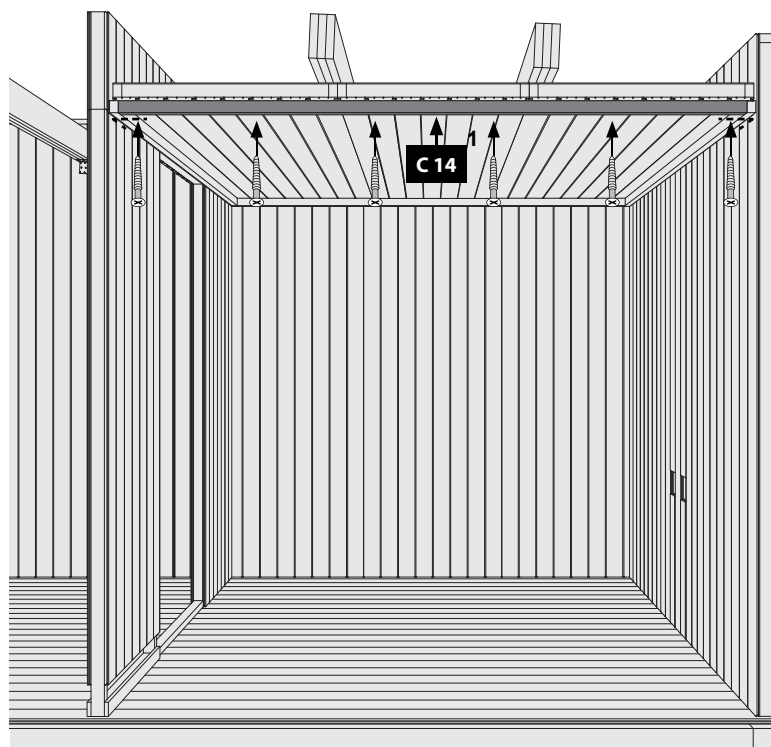
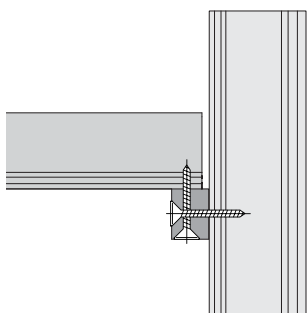
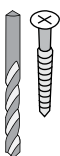

Ø3mm  
12x  
4x50



-  Bündig!
-  Flush!
-  Affleurement!
-  Gelijk!
-  I flugt!
-  Aras!
-  Combacia!
-  Stejný!
-  Splakovanie!

-  Schmale Seite nach oben
-  Narrow side up
-  Narrow vers le haut
-  Smal side op
-  Smalle kant boven
-  Estrecha hacia arriba

-  Stretta verso l'alto
-  Úzká stranou nahoru
-  Ozka stran navzgor

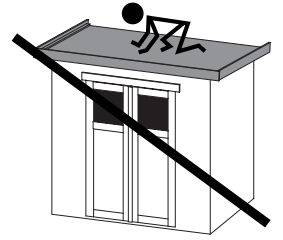
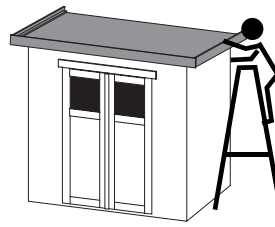

20

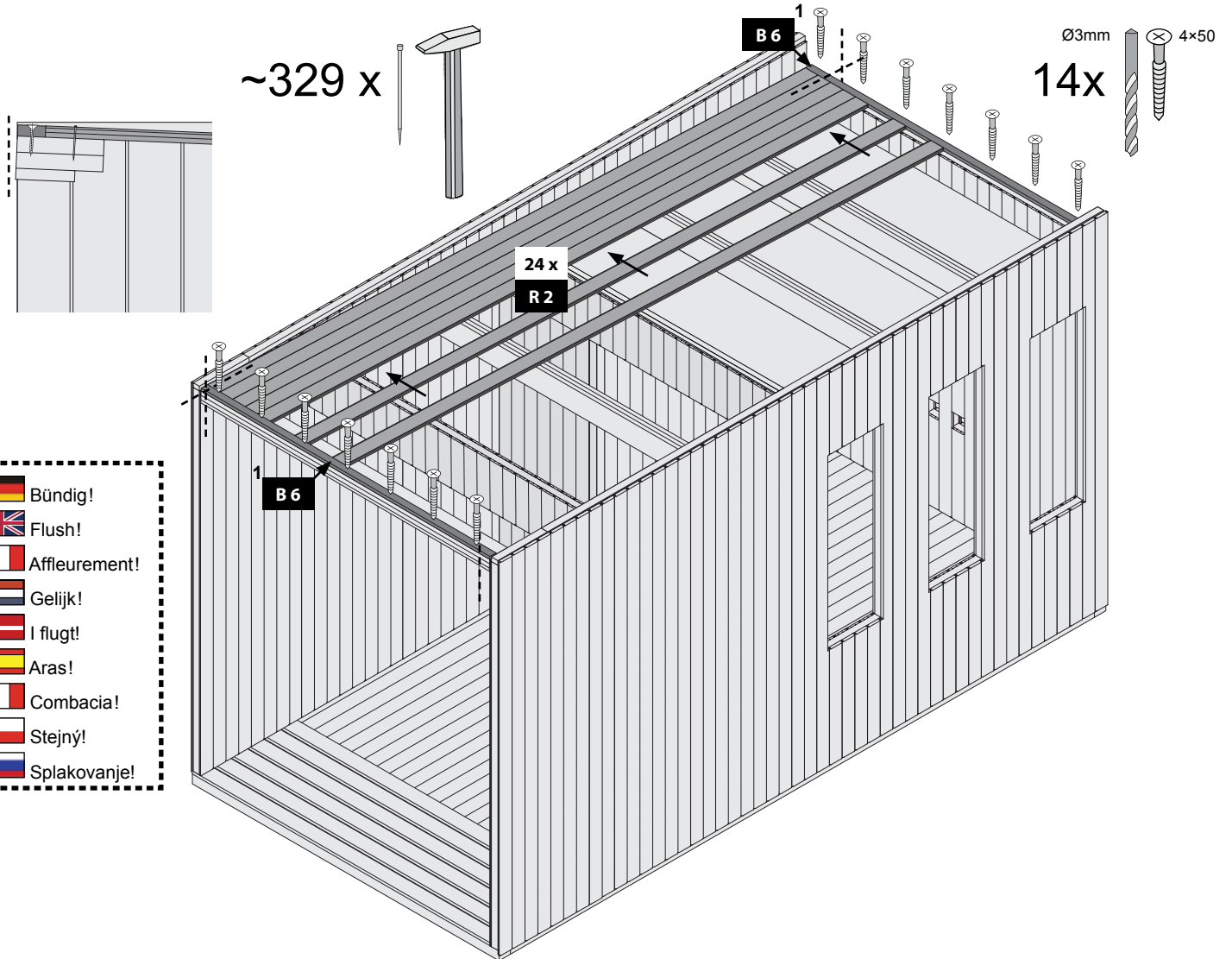

-  Bündig!
-  Flush!
-  Affleurement!
-  Gelijk!
-  I flugt!
-  Aras!
-  Combacia!
-  Stejný!
-  Splakovanje!

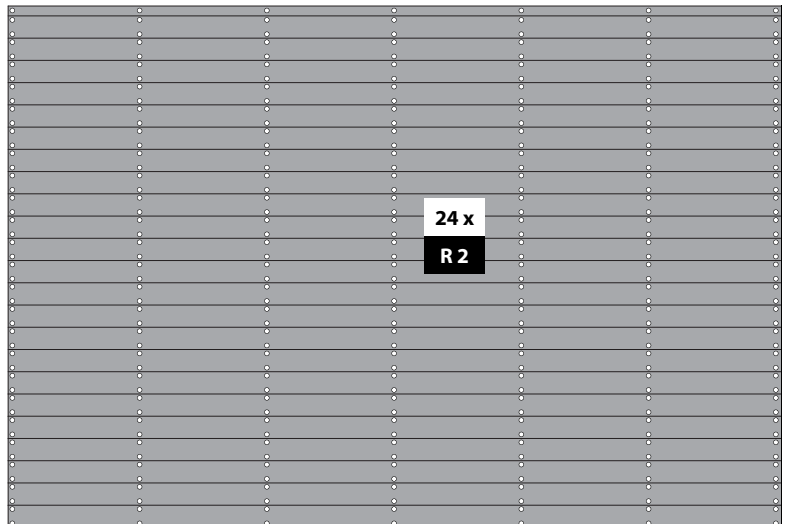
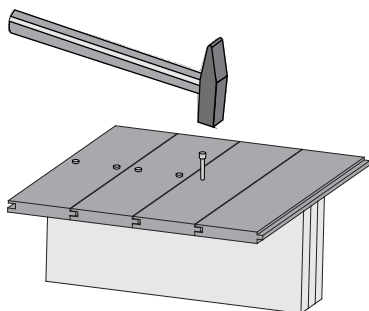



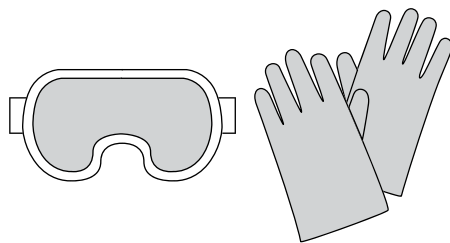

01

-  Tür in den Rahmen legen
-  Put the door in the frame
-  Mettez la porte dans le cadre
-  Plaats de deur in het frame
-  Sæt døren i rammen
-  Pon la puerta en el marco
-  Metti la porta nel telaio
-  Vložte dveře do rámu
-  Vrata namestite v okvir

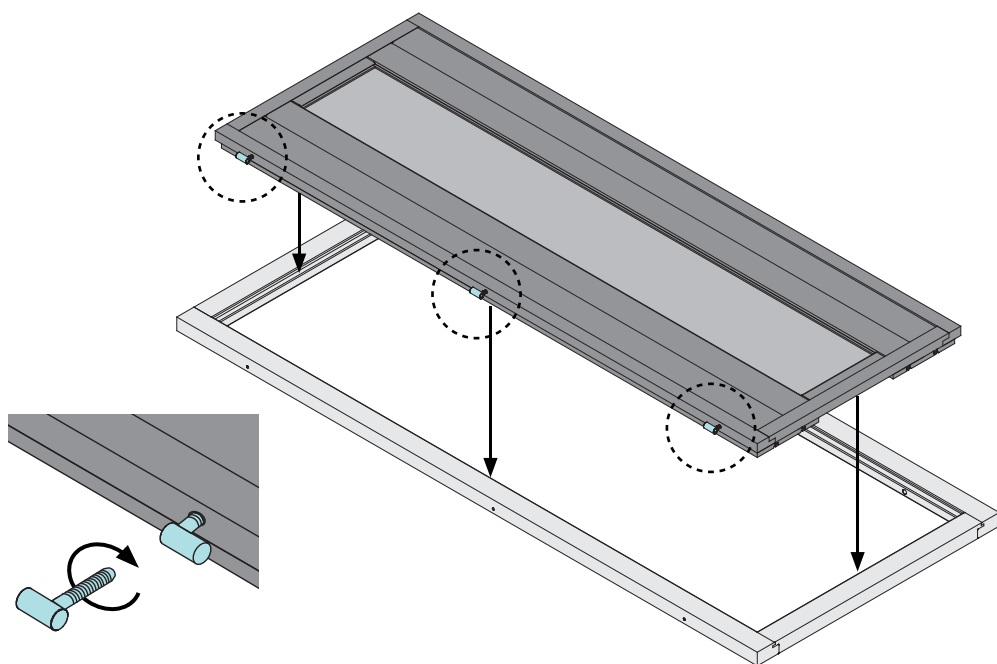

02

-  Tür im Rahmen ausrichten
-  Center the door in the frame
-  Aligner la porte dans le cadre
-  Lijn de deur in het frame uit
-  Juster døren i rammen
-  Alinea la puerta en el marco
-  Allinea la porta nella cornice
-  Zarovnejte dveře do rámu
-  Poravnajte vrata v okvir

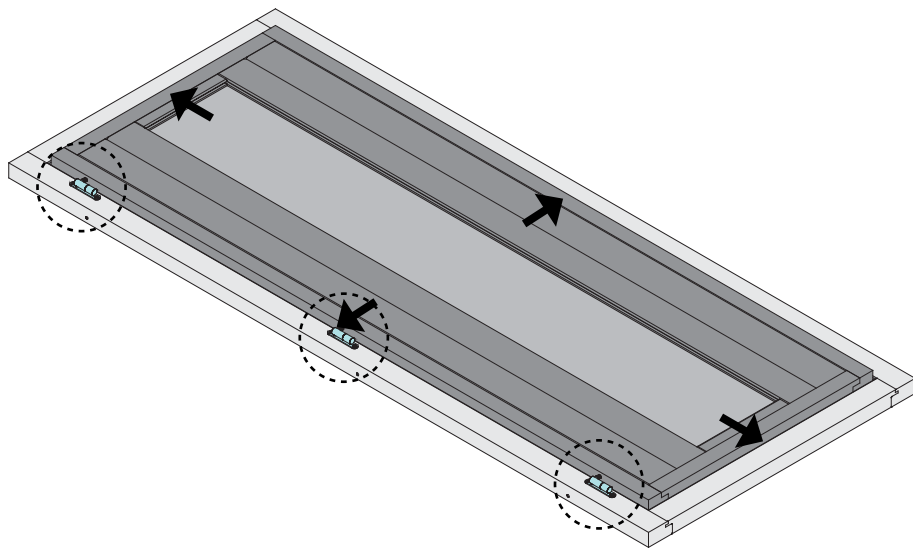

1.

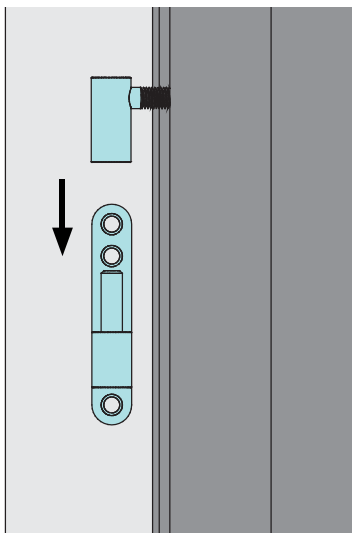

2.

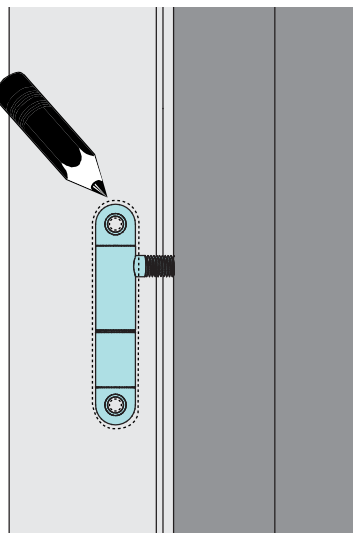

3.

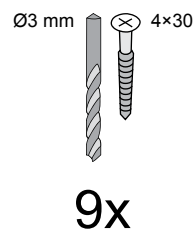
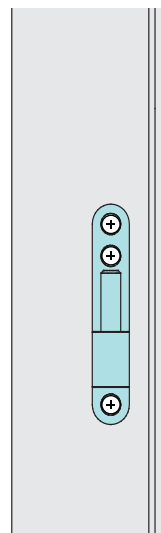

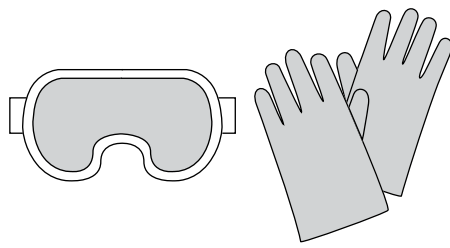

03

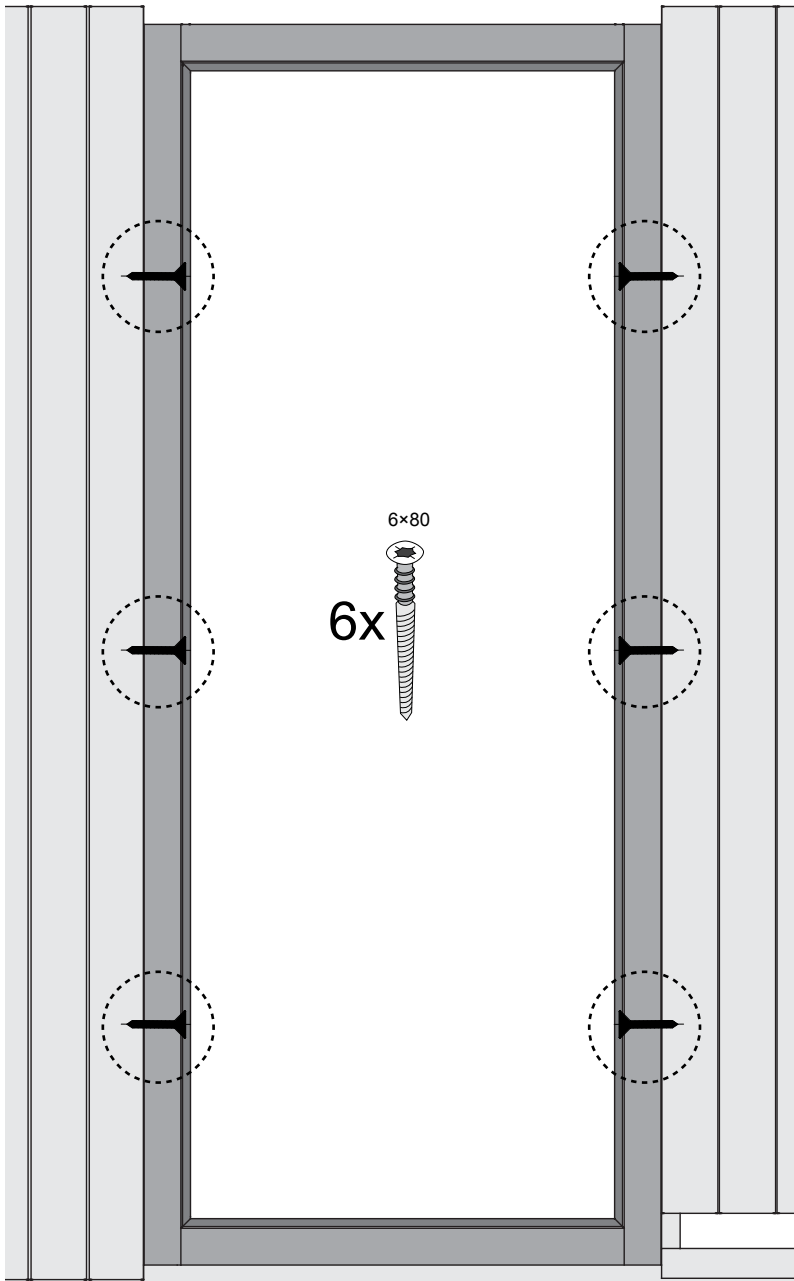
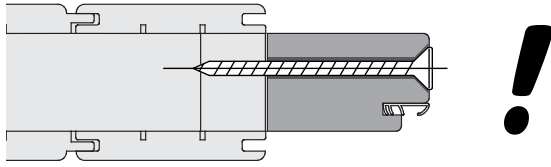

1.

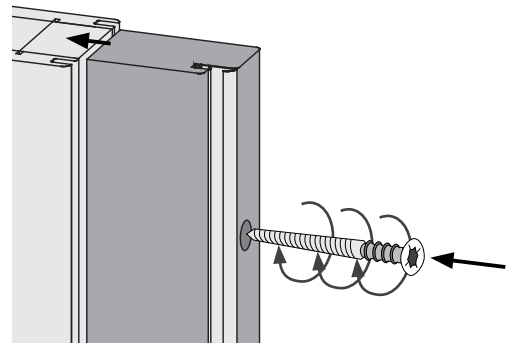

2.

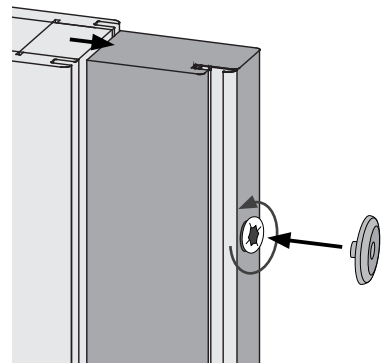

# 1.

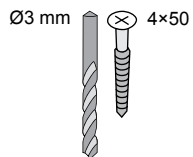
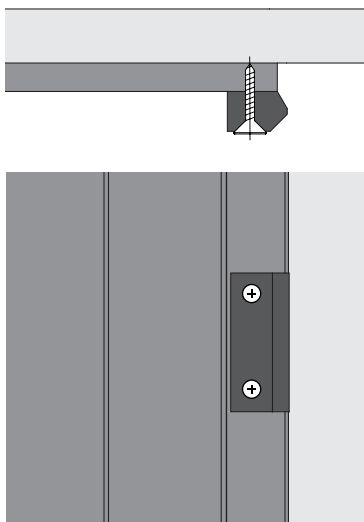

2x

# 2.

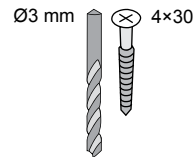
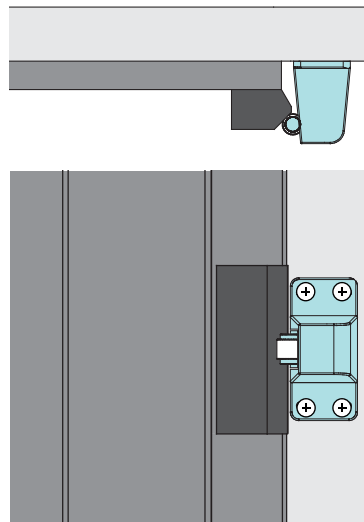

4x

# 3.

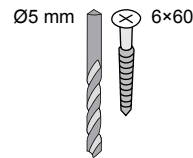
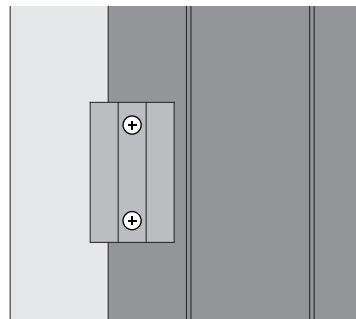
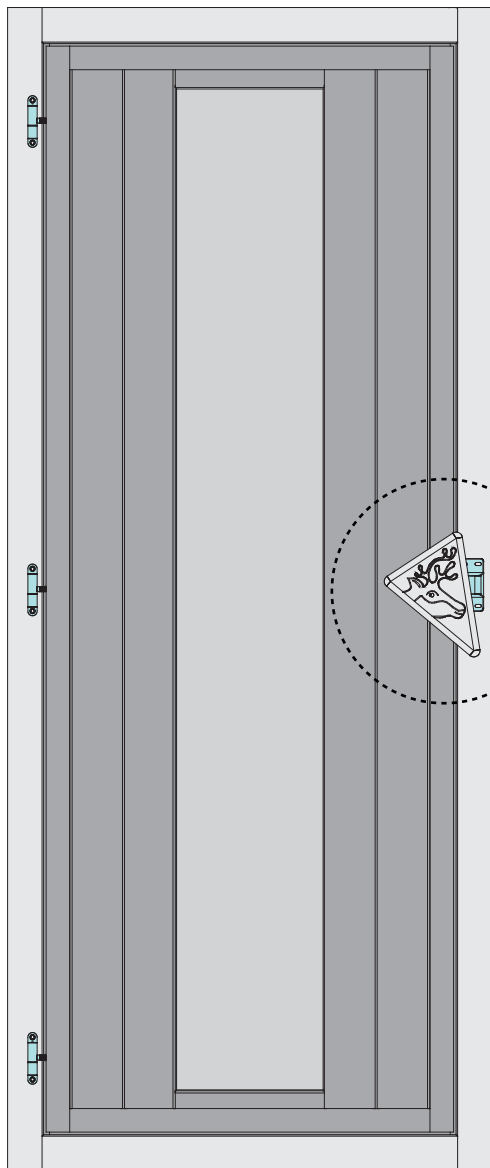

2x

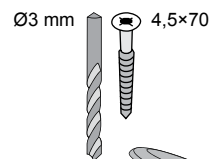
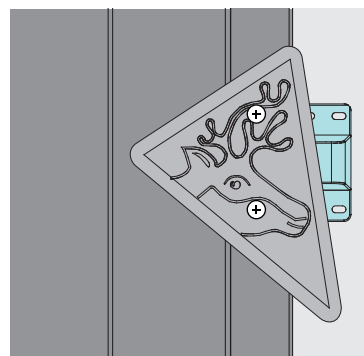
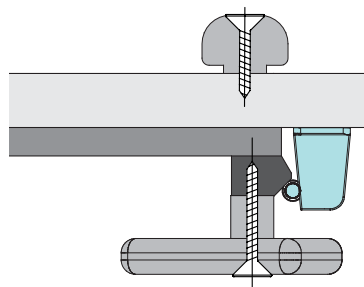

2x

# 18x

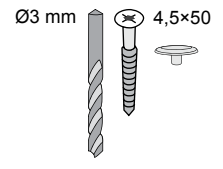

-  außen
-  outside
-  à l'extérieur
-  buiten
-  udenfor
-  fuera
-  al di fuori
-  vně
-  zunaj

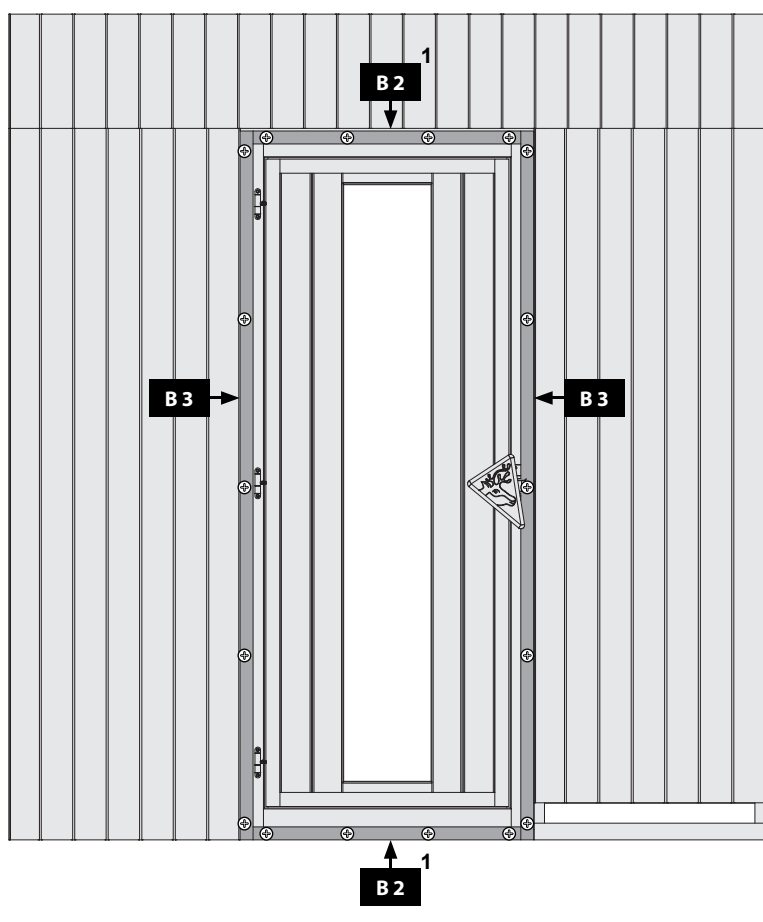

# 18x

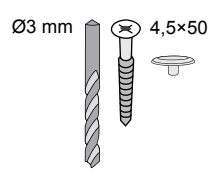

-  innen
-  Inside
-  à l'intérieur
-  inde på
-  binnen
-  dentro
-  dentro
-  uvnitř
-  znotraj

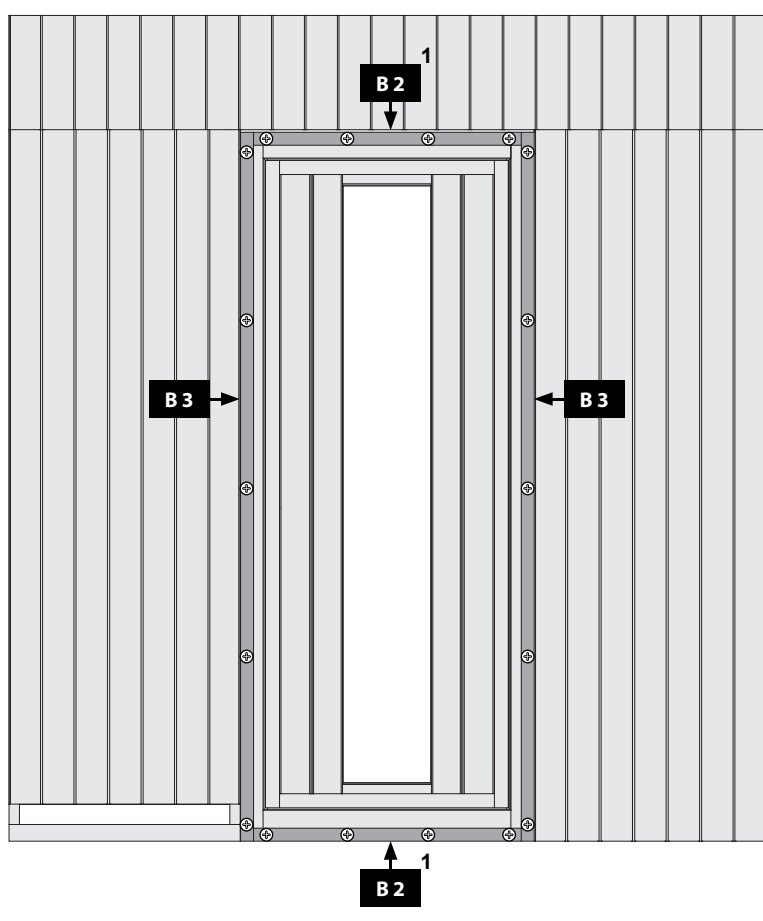

32x

Ø3 mm 4,5x50



24

3x

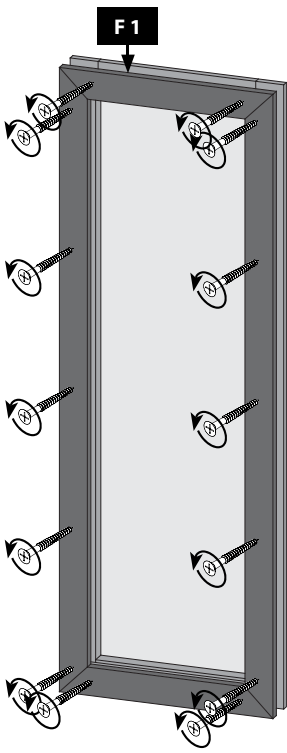

25

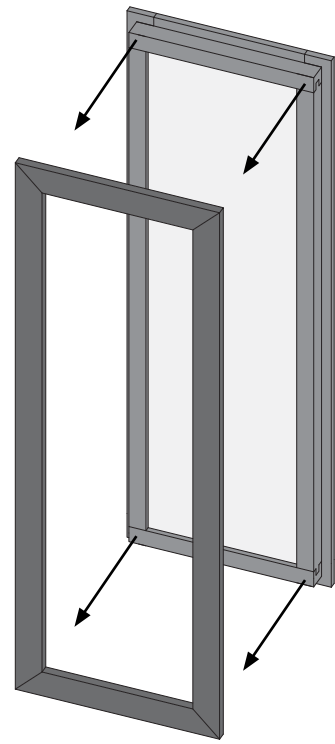

26

Ø3mm  
14x

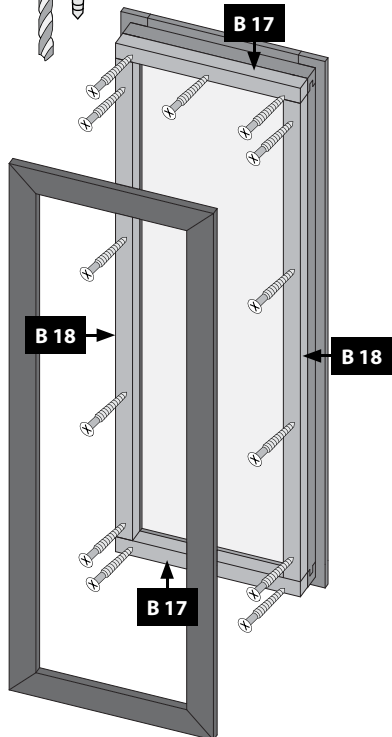
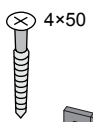

27

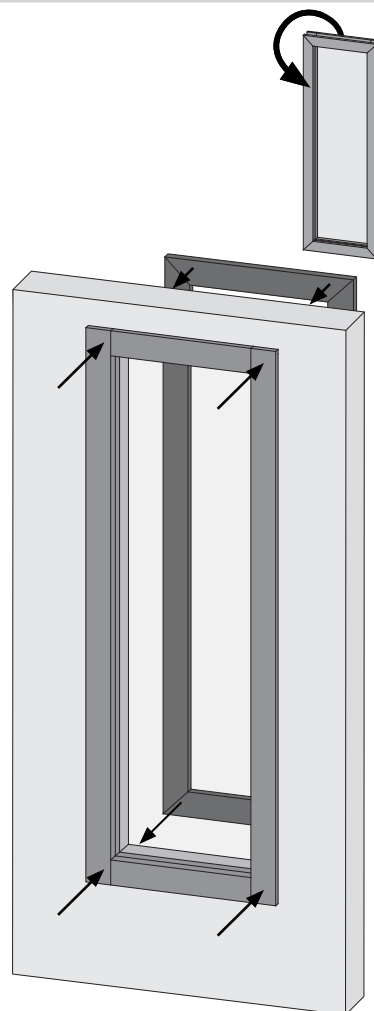

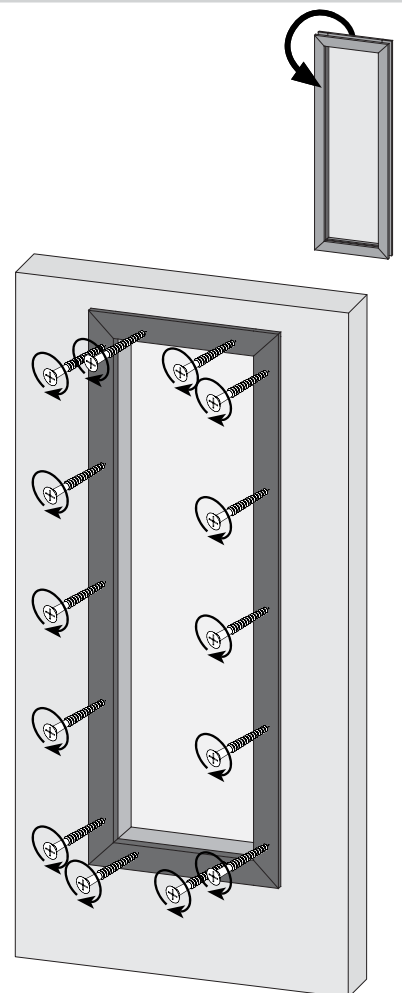

28

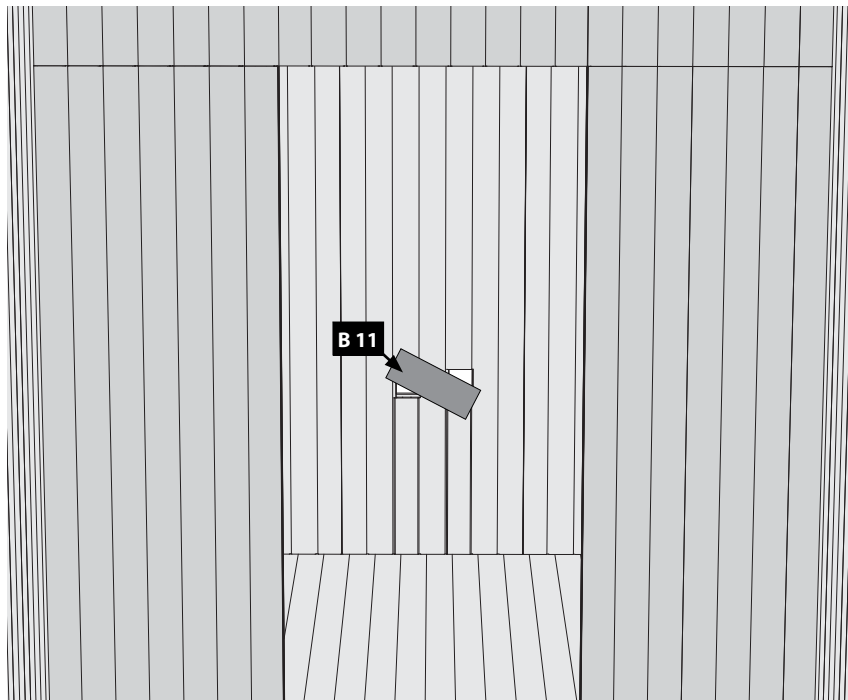



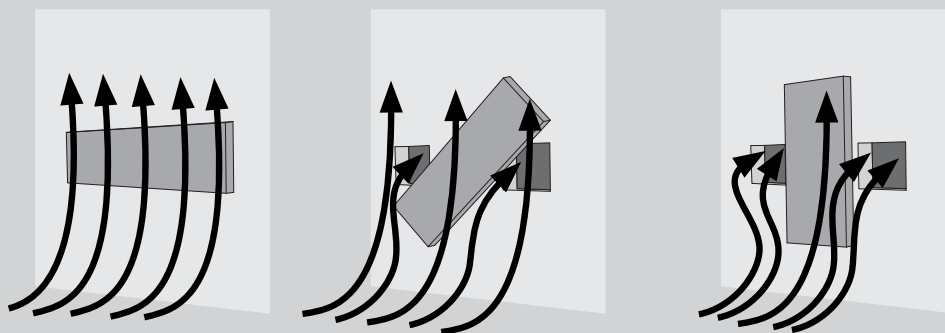
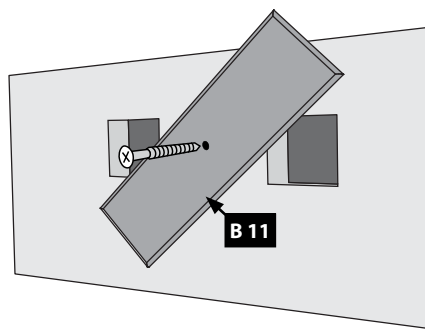
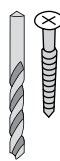

Ø3mm 4x50





 Hier ist die Funktionsweise des Brettes abgebildet. Regeln Sie damit die Abluft nach Ihren eigenen Wünschen

 This figure shows the functional principle of the board. Regulate the exhaust air according to your own wishes

 Ceci représente le mode de fonctionnement de la planche. Avec elle, réglez l'écoulement de l'air selon vos désirs.

 Hier is de werking van het plankje afgebeeld. Regel daarmee de luchtafvoer naar eigen wens

 Sådán fungerer styret. Brug den til at regulere udstødningsluften efter dine egne ønsker

 Aquí está representada la forma de funcionamiento de la tabla. Regule con ello el aire de salida según sus propios deseos

 Viene illustrato il principio di funzionamento della tavoletta di regolazione della ventilazione. Con essa si può regolare a piacere la ventilazione

 Zde je zobrazená funkce desky. Regulujte s ní odsávací vzduch dle Vašeho přání

 Tukaj si lahko ogledate delovanje plošče. Z njo lahko uravnavate izpušni zrak po lastnih željah.

-  außen
-  outside
-  à l'extérieur
-  buiten
-  udenfor
-  fuera
-  al di fuori
-  vně
-  zunaj

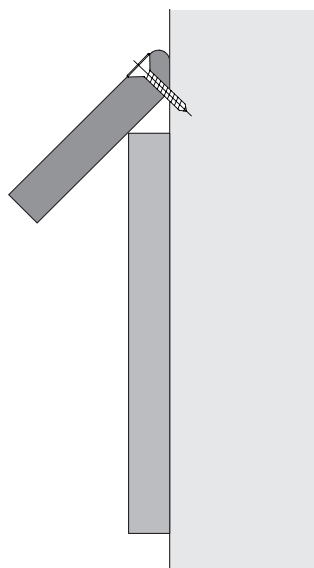
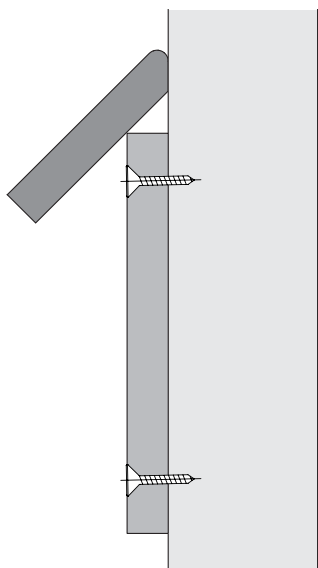
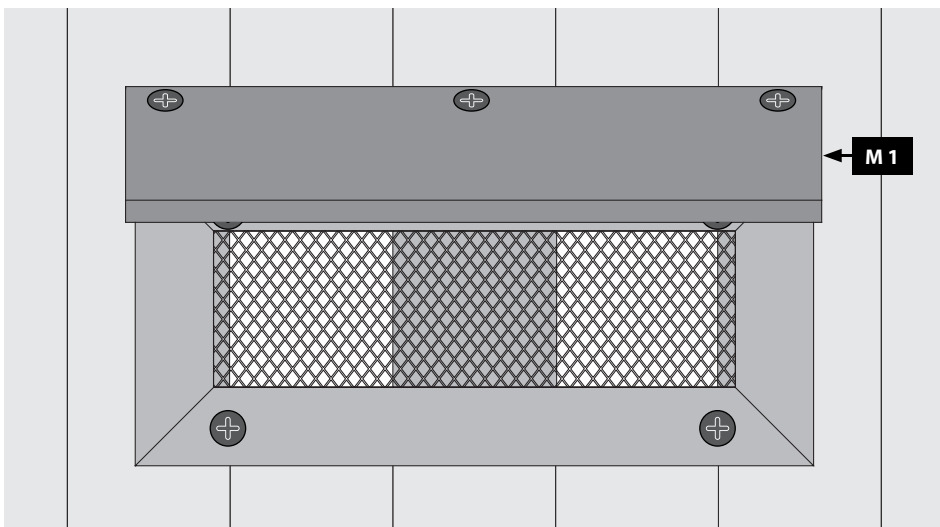
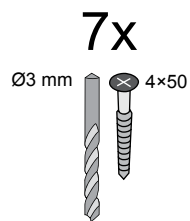



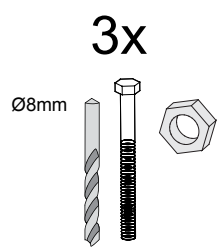
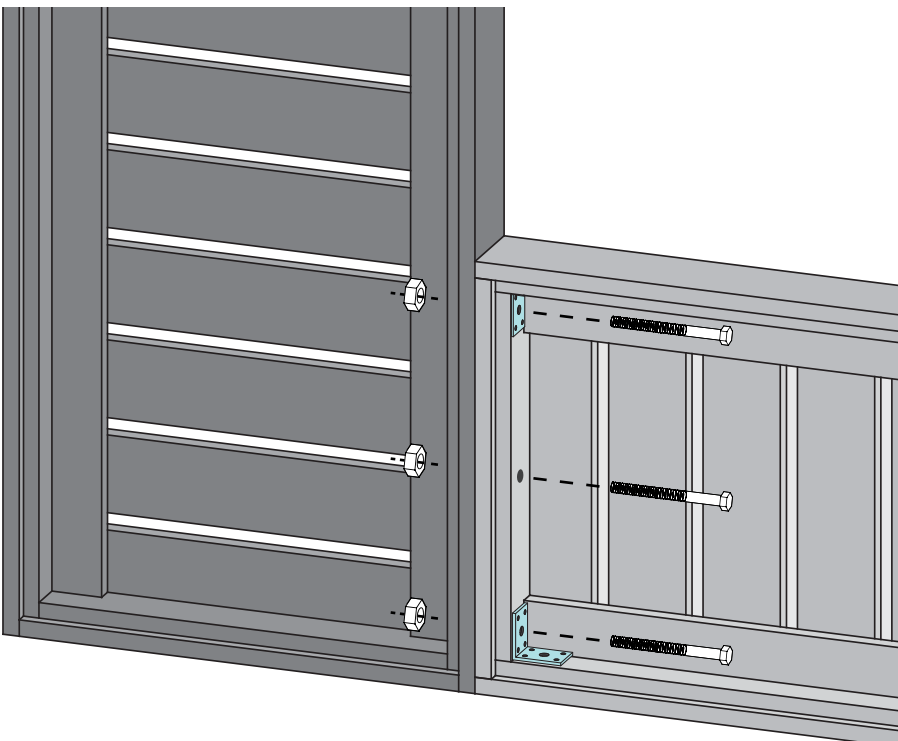
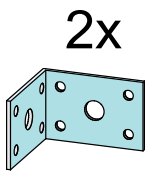
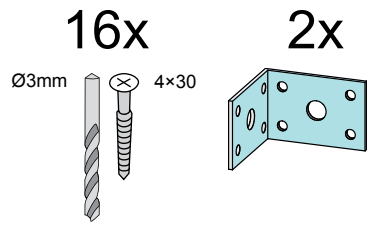
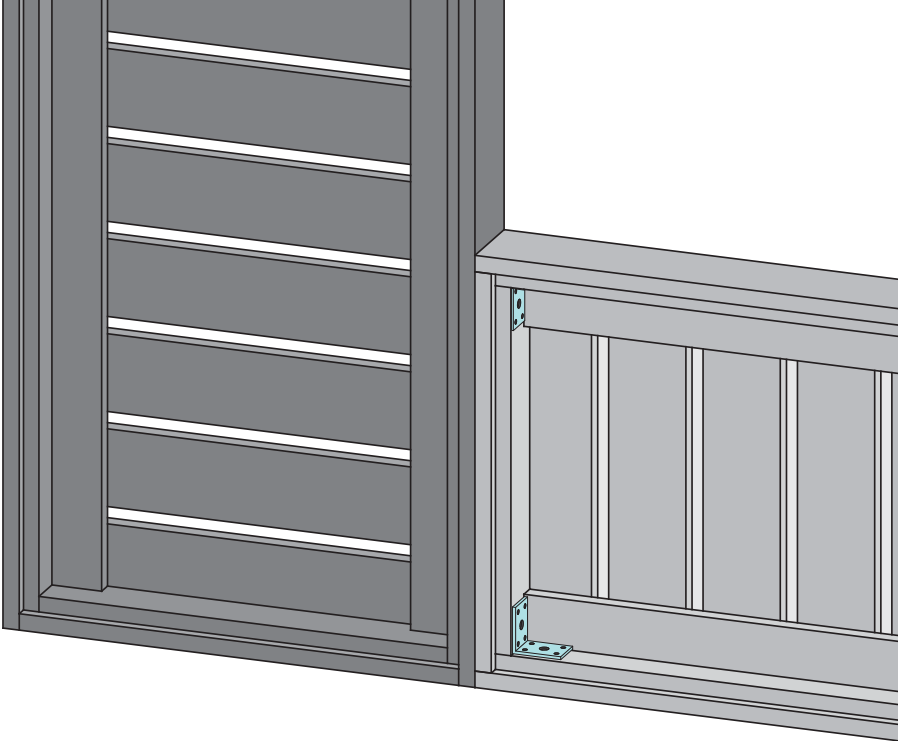
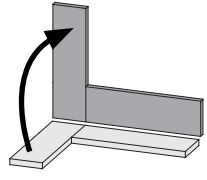
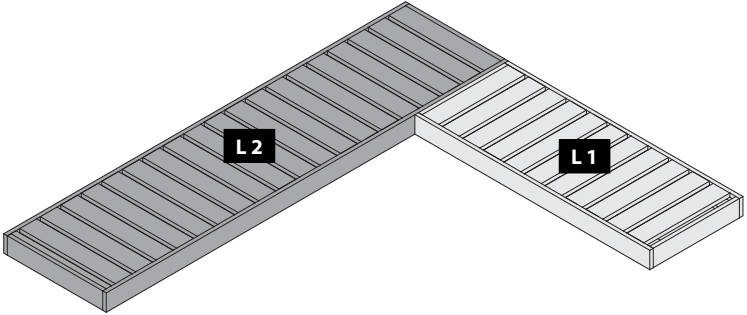

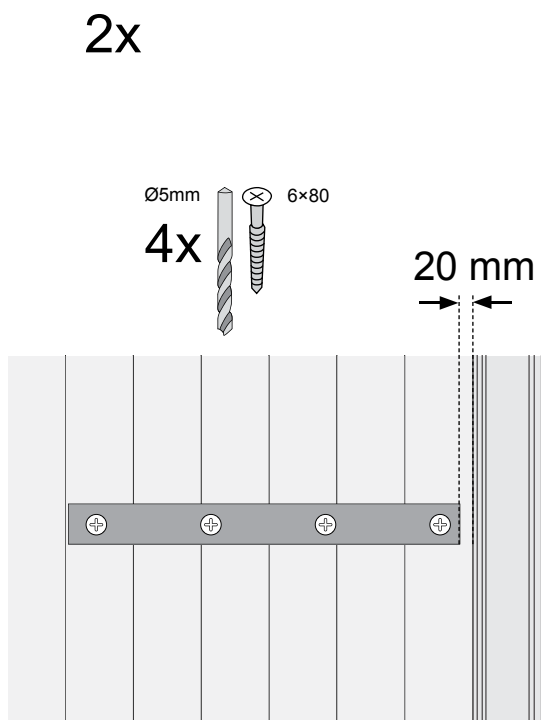
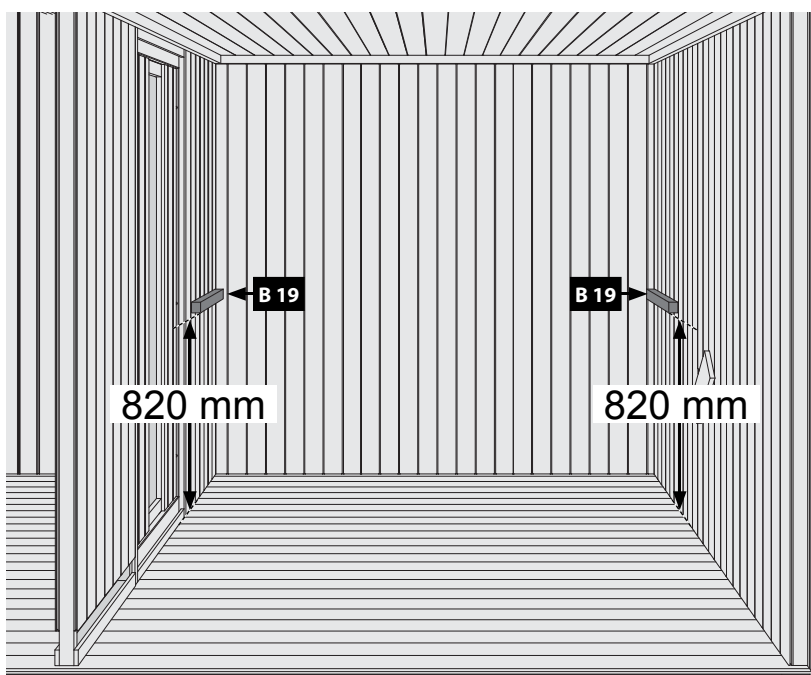

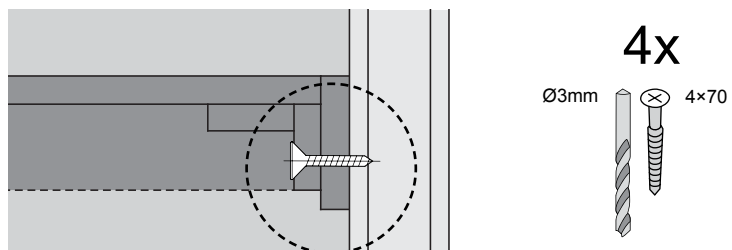
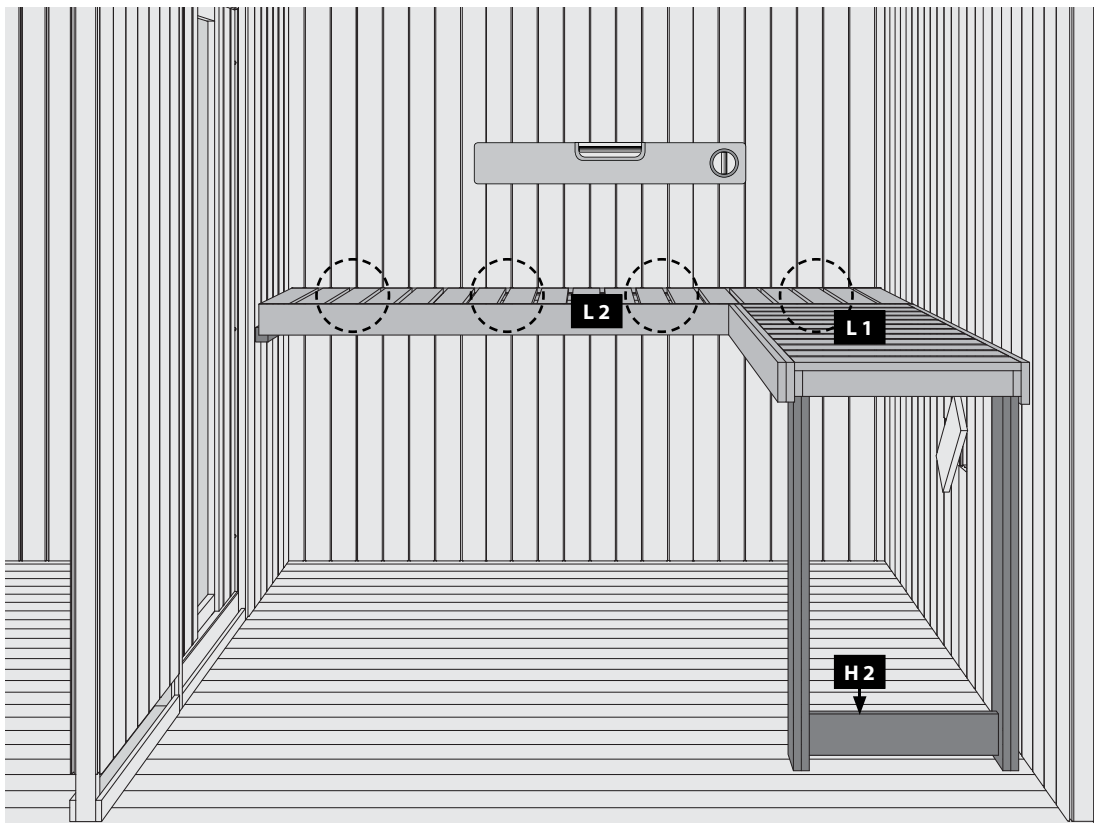
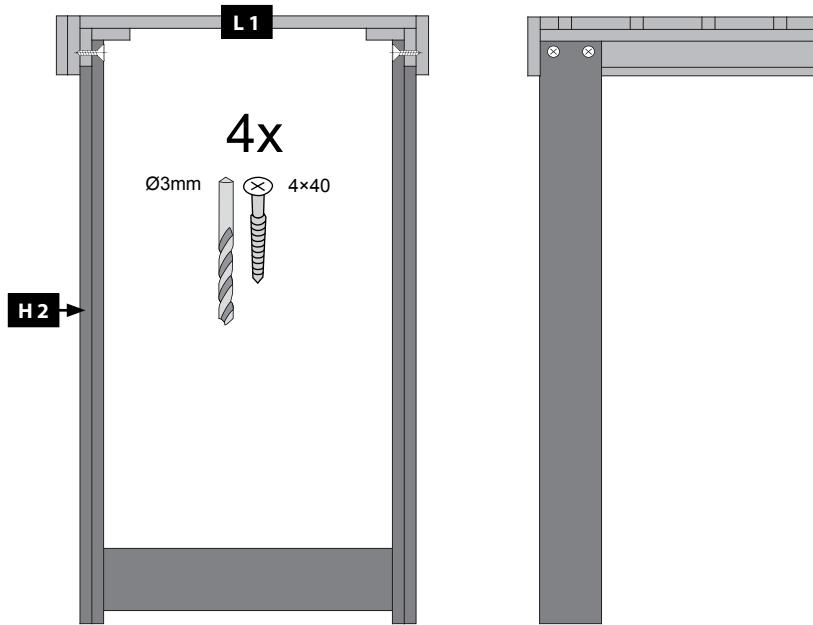

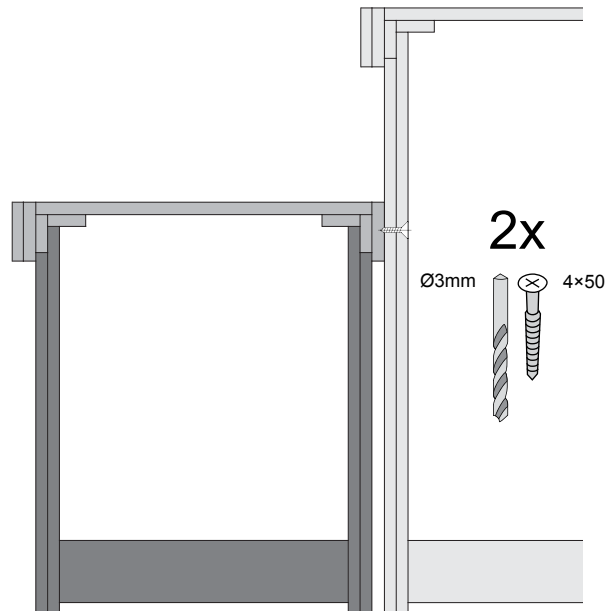
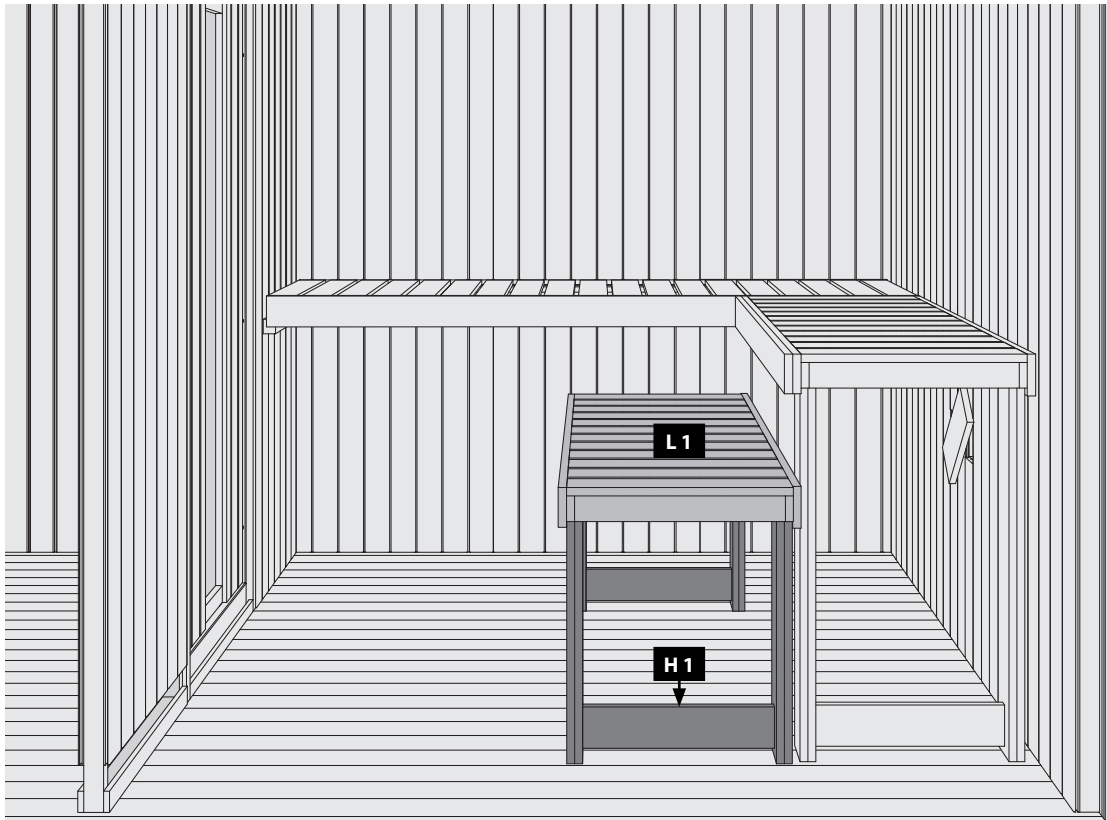
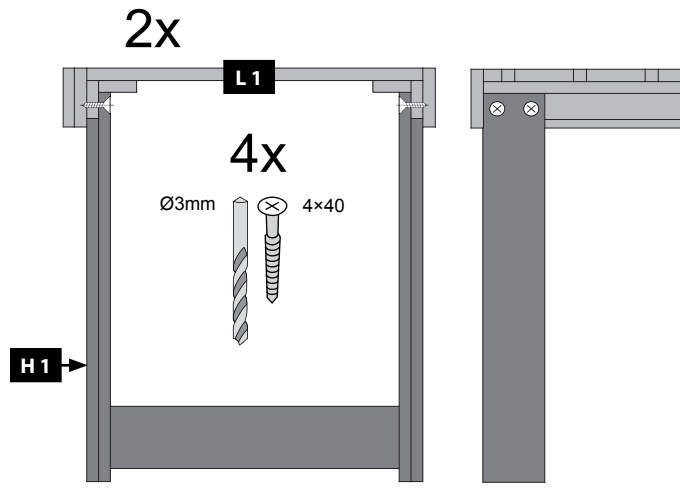

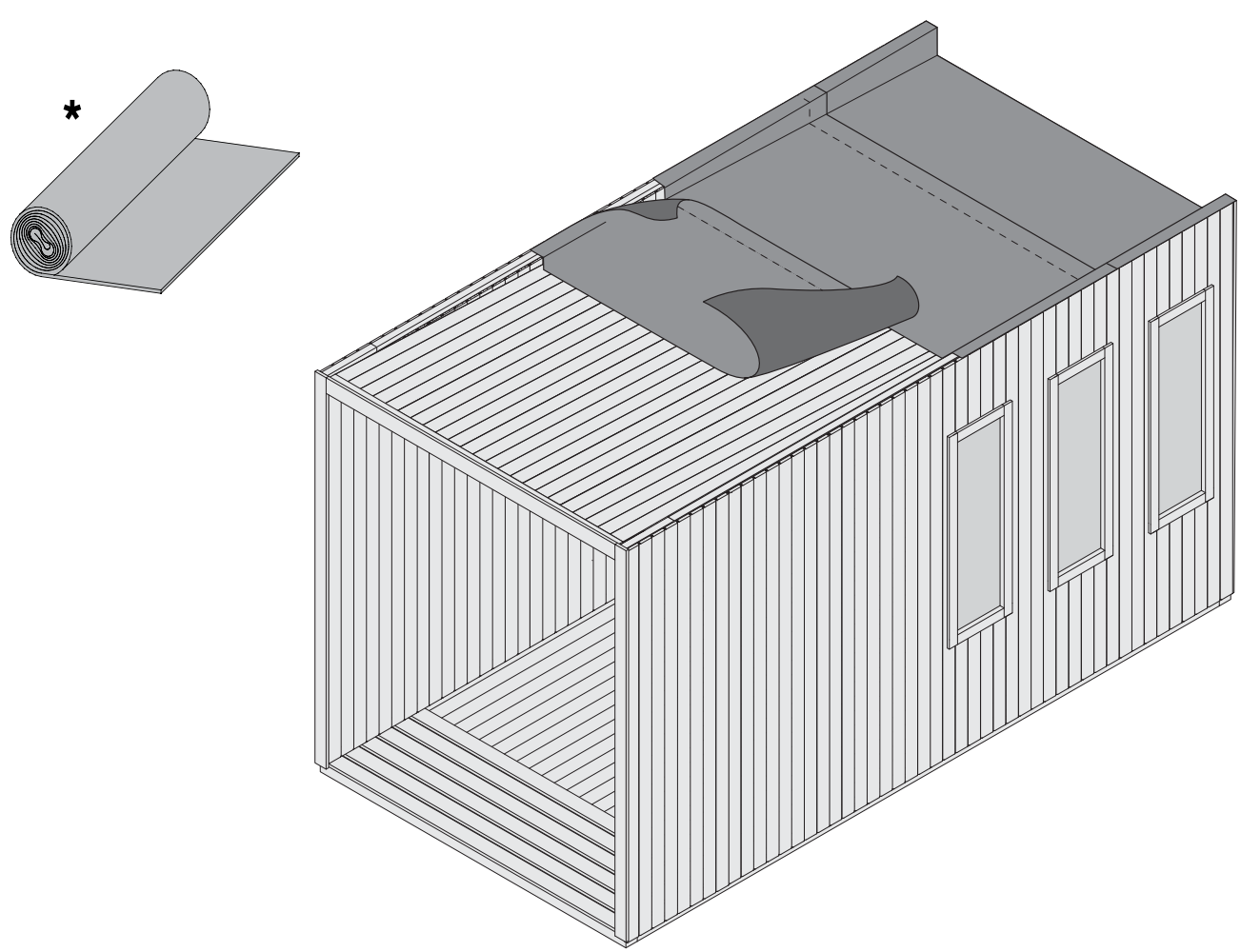
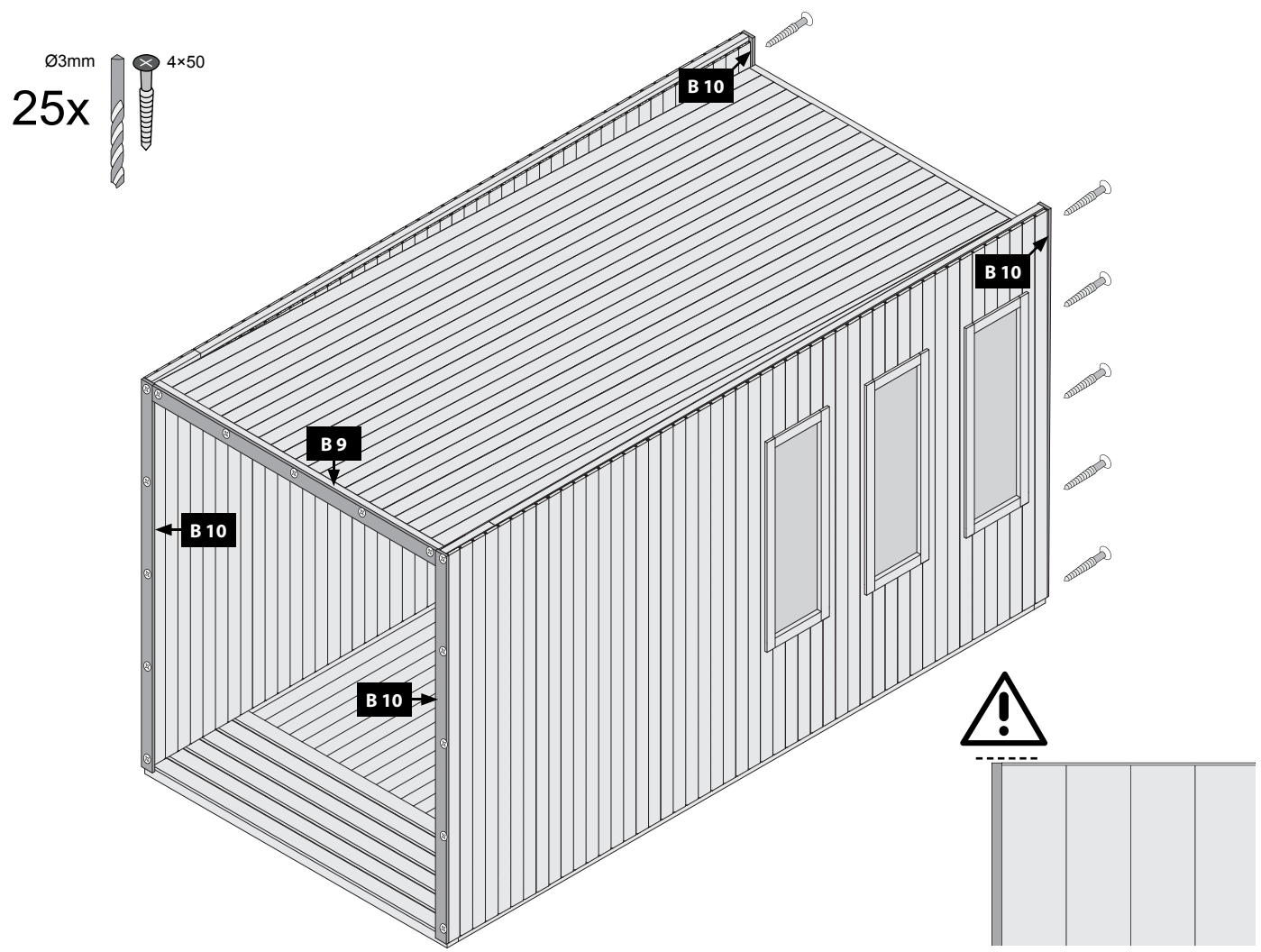



 Montage Bitumendachbelag

 Montage dakvilt

 Copertura bituminosa

 Roofing felt installation

 Samling bitumen tagdækning

 montáž střešní krytiny

 Montage de toiture en bitume

 Montaje de tela asfáltica

 Montáža bitumenske strešne kritine

### **Achtung, dies ist nur ein Verlegebeispiel!**

Der Bitumendachbelag dient zur Ersteindeckung und sollte nach 2 Monaten durch ein eigenes Produkt ergänzt werden. Die Anzahl der Bahnen richten sich nach Ihrer Hausgröße. Verbindungen zwischen den Bahnen sind mit einer Überlappung von ca. 10 cm auszuführen. Das Dach ist nicht begehrbar. Die Konstruktion ist für eine Gesamtbelastung (Schnee, Wind) und nicht für eine Punktbelastung ausgelegt. Zur Montage empfehlen wir eine bauseitige Abstützung des Daches von unten. Die Abdichtung der Dachflächen zu angrenzenden Bauteilen mit Bitumendichtmasse ist bauseits zu lösen! Sofern es sich um ein Haus mit Satteldach handelt, sollte bei der Verwendung von Dachschindeln keine Voreindeckung mit Dachpappe vorgenommen werden. Hier sollte lediglich an den beiden Traufseiten ein 20 cm breiter Streifen mit Überstand angebracht werden. Bei Häusern mit einem Tonnendach, verlegen Sie bitte einen Bitumenbelag unter die Schindeln. Bei einem Flachdach ist die Verlegung von Dachschindeln nicht möglich!

### **Note! This description is only an example!**

The bitumen roofing is used for initial cover and should be supplemented by a separate product according to customer's choice after two months. The number of bitumen strips to be used depends on your actual house size. When joining rolls of roofing felt end to end, the overlap must be approximately 10cm. The roof is not safe to walk on. The roof is designed for a total load (snow, wind) and not for a point load. We recommend you to always support the roof from below during installation. The sealing of the roof surfaces to adjacent components with bitumen sealant has to be effected by the customer! If it is a saddle-roofed house, do not use roofing tiles for roofing. In this case, a 20 cm wide strip of bitumen with overhang should be installed on both sides of the eaves. For houses with a gable roof, please install a bitumen roofing under the shingles. In the case of a flat roof the laying of roof shingles is not possible!

### **Attention, il s'agit uniquement d'un exemple de pose!**

Le revêtement du toit s'entend comme équipement initial. Il est donc recommandé de le compléter par un produit de votre choix après 2 mois. Le nombre de bandes de bitume utilisées dépend de la dimension de la maison. La jointure des bandes de bitume doit être réalisée avec un chevauchement de 10 cm. Ne pas marcher sur le toit! La construction est appropriée pour une charge totale (neige, vent) et ne pas une charge ponctuelle sur un point précis. Lors du montage, il vous est recommandé de soutenir le toit d'en dessous. L'imperméabilisation des surfaces de toit aux composants adjacents avec un mastic de bitume doit être effectuée par le client! Lorsque vous utilisez des bardeaux pour couvrir une maison avec un toit à deux versants, ne jamais utiliser toiture en bitume ci-dessous. Pour les maisons avec toit en berceau, poser du carton bitumé sous les bardeaux. Pour les maisons de toit plat de la pose de bardeaux de toiture n'est pas possible!

### **Let op, dit is slechts een montagevoorbeeld!**

De bitumen dakbedekking wordt gebruikt voor initiële en moet worden aangevuld met een afzonderlijke product na 2 maanden. Het aantal dakviltbanen is afhankelijk van de grootte van uw huis. Verbindingen tussen de stroken uit te voeren met een overlapping van ongeveer 10 cm. Het dak is niet beloopbaar. De constructie is ontworpen voor een totaalbelasting (sneeuw, wind) en niet voor een puntbelasting. Voor de montage adviseren we te voorzien in een zelf aan te brengen steun voor het dak van onderen. De afdichting van de dakoppervlakken van aangrenzende componenten met bitumen afdichtmiddel op te lossen door de klant! Als het gaat om huis met een zadeldak, mag geen Voreindeckung worden gemaakt met dakleer in het gebruik van dakbedekking gordelroos. Hier, moet alleen de twee dakrand zijden een 20cm brede strook dakleer aan te leggen met een overstek. Voor huizen met een dak vat installeer dan een dakleer onder de gordelroos. Met een plat dak leggen shingles is niet mogelijk!

### **Bemærk, dette er kun et monterings eksempel!**

Bitumentagbelægningen bruges til den første belægning og skal suppleres med et separat produkt efter 2 måneder. Antallet af påkrævede ruller af tagbeklædning afhænger af husets faktiske størrelse. Ved sammenføjning af tagdækning ruller ende til ende, skal overlappningen være 10 cm. Når du kun bruger 4 baner af tagpap, skal du altid dække den vandrette kantbjælke med rullerne fra begge sider. Taget er ikke sikkert at gå på. Taget er designet til en total belastning (sne, vind) og ikke for en punktbelastning. Vi anbefaler at du altid støtter taget nedenunder under installationen. Tætningen af tagfladerne til vindbrættet i forenderne skal løses af kunden! Når du bruger tagshingles til at inddække et hus med gavltag, skal du altid bruge underpap tagbeklædningen. Her lægges et 20 cm bredt bånd af tagbeklædning med overlæg på begge sider. Monter altid underpap tagbeklædningen under tagshingles til huse med et buet tag. Tagshingles kan ikke bruges på flade tage!

### **Cuidado, éste es sólo un ejemplo de instalación!**

La cubierta de betún suministrado se utiliza para inicial y debe complementarse con un producto separado después de 2 meses. La cantidad de tiras de tela asfáltica depende del tamaño de su caseta. Las juntas de tela en una tira se realizan solapando la tela asfáltica 10 cm. El techo no es transitable. La construcción está preparada para cargas totales (nieve, viento) y no para cargas puntuales. Para el montaje se recomienda apuntalar el techo por debajo. A menos que haya una casa de techo a dos aguas, sin Voreindeckung debe hacerse con tela asfáltica en el uso de tejas para techos. En este caso, sólo los dos aleros partes deben ser de una amplia franja de 20 cm de tela asfáltica que deben colocarse con un voladizo. Para las casas con el techo abovedado y por favor, instale un techo sintió debajo de las tejas. Con un techo plano por el que las tejas no es posible!

 Montage Bitumendachbelag

 Roofing felt installation

 Montage de toiture en bitume

 Montage dakvilt

 Samling bitumen tagdækning

 Montaje de tela asfáltica

 Copertura bituminosa

 montáž střešní krytiny

 Montáža bitumenske strešne kritine

### **Attenzione, questo è solo un esempio di posa!**

La copertura bitume fornito è utilizzato per iniziale e deve essere completato da un prodotto separato dopo 2 mesi. La quantità dei rulli di cartone catramato dipende dalle dimensioni della casa. Il concatenamento tra i nastri deve essere effettuata con una sovrapposizione di circa 10 cm. Non salire sul tetto. La costruzione è progettata per un carico diffuso (neve, vento) e non per una concentrazione puntuale del peso. Per il montaggio si consiglia un supporto del tetto con una costruzione posta sotto di esso. Se si dispone di una casa con un tetto a capanna e si desidera utilizzare tegole di copertura, deve essere posato senza fogli di bitume. Qui, un largo 20 cm striscia di bitume deve essere montato esclusivamente ad entrambi i lati della grondaia sporgente 20 cm. Per le case con fogli di bitume per tetti a botte sotto il fuoco di Sant'Antonio da installare. Si prega di non utilizzare il fuoco di Sant'Antonio Dackdeckung con un tetto piatto.

### **Pozor, toto je jen příklad, kterým!**

Dodaný bitumen se používá pro počáteční a by měl být doplněn samostatný produkt po 2 měsících.

Počet Dachpappbahnen závisí na velikosti domu. Spojení mezi asfaltem pásu má být provedena s přesahem asi 10 cm. Při použití pouze čtyři běhy ne Firstbahn použití, boční panely s ležel přes hřeben. Střecha není přístupný. Konstrukce je (sníh, vítr) a není určen pro bodové zatížení na celkové zatížení. Pro montáž doporučujeme znovu podporu na místě střechy zespodu. Utěsnění střešních oblastí do podhledů na čelních plochách je na místě řešit! Máte-li dům se sedlovou střechou, je třeba žádné Asfaltové pásy umístěny pod šindele. Zde je 20 cm široký pás střešní plst' je pouze na obou stranách okapového se supernatantem odloženou. Pro rodinné domy s valenou střechou prosím ležel lepenkový pod šindelem. Pro ploché střechy domů pokládka střešních šindelů není možné!

### **Pozor, to je le primer namestitve!**

Priložena bitumenska strešna kritina je namenjena začetnemu prekrivanju in jo je treba po dveh mesecih dopolniti z lastnim izdelkom. Število listov je odvisno od velikosti vaše hiše. Stiki med ploščami morajo biti izvedeni s prekrivanjem približno 10 cm. Po strehi se ne sme hoditi. Konstrukcija je zasnovana za splošno obremenitev (sneg, veter) in ne za točkovno obremenitev. Pri montaži priporočamo, da streho od spodaj podpre stranka. Tesnjenje strešnih površin s sosednjimi gradbenimi elementi z bitumensko tesnilno maso mora rešiti stranka! Če gre za hišo z dvokapno streho, pri uporabi strešnikov ni treba izvesti predhodnega prekrivanja s strešno lepenko. V tem primeru je treba na obeh straneh ostrešja uporabiti le 20 cm širok pas s previsom. Pri hišah s sodasto streho pod skodelo položite bitumensko prevleko. Na ravno streho ni mogoče položiti skodel!

# 28x

Ø3 mm 4x35

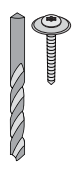

-  Bündig!
-  Flush!
-  Affleurement!
-  Gelijk!
-  I flugt!
-  Aras!
-  Combacia!
-  Stejný!
-  Splakovanie!

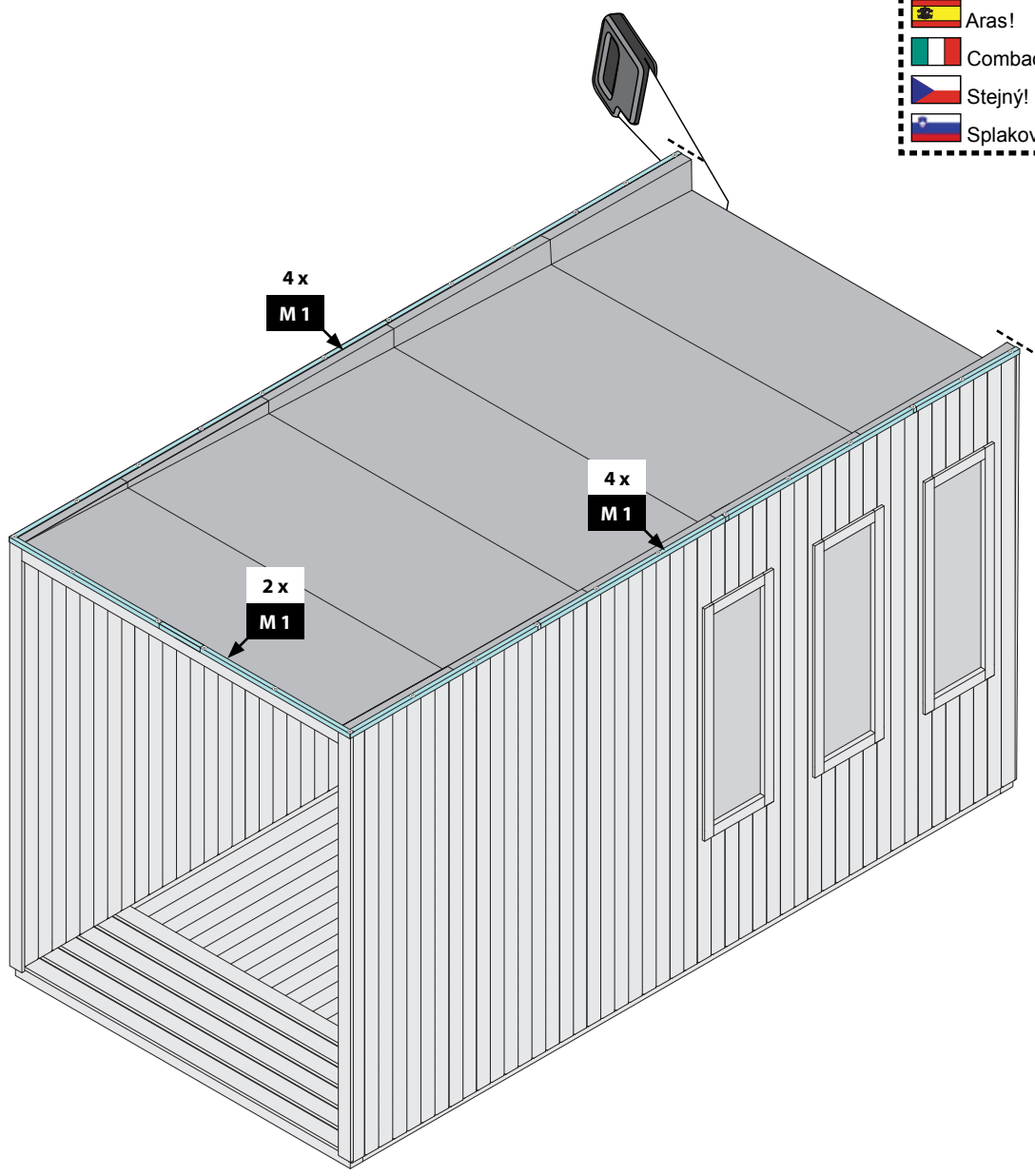



40 2x

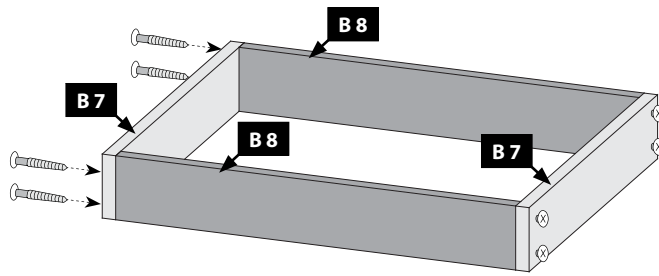

Ø3 mm 4x35  
16x

A diagram of a 3 mm diameter drill bit and a 4x35 mm screw. The drill bit is shown next to the screw, which has a Phillips head.

41

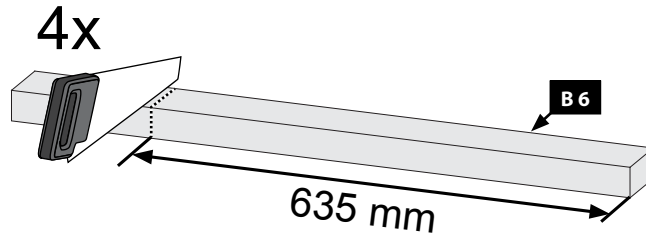

42

Ø3 mm 4x35  
16x

A diagram of a 3 mm diameter drill bit and a 4x35 mm screw. The drill bit is shown next to the screw, which has a Phillips head.

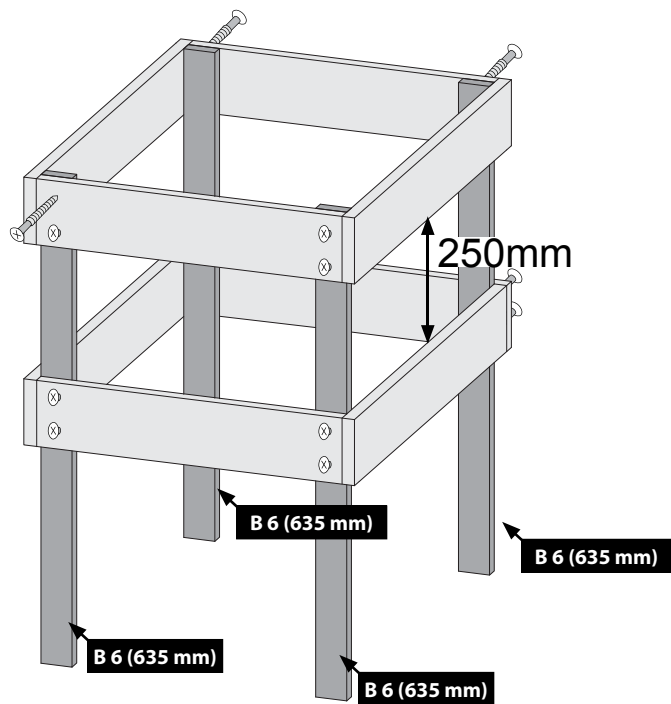

Ø3 mm 4x35  
 4x

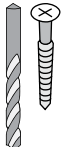
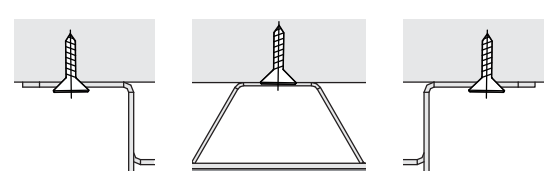
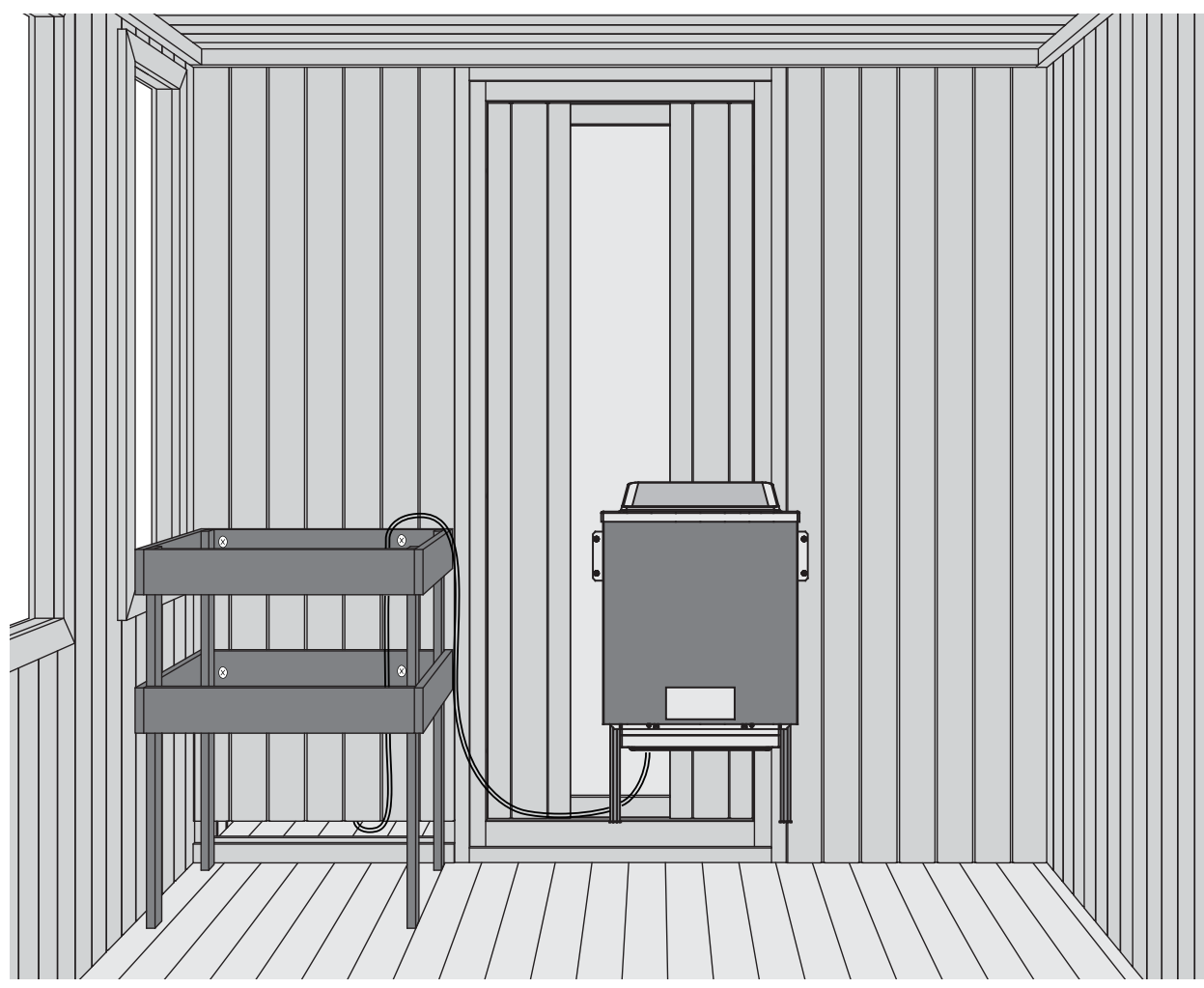

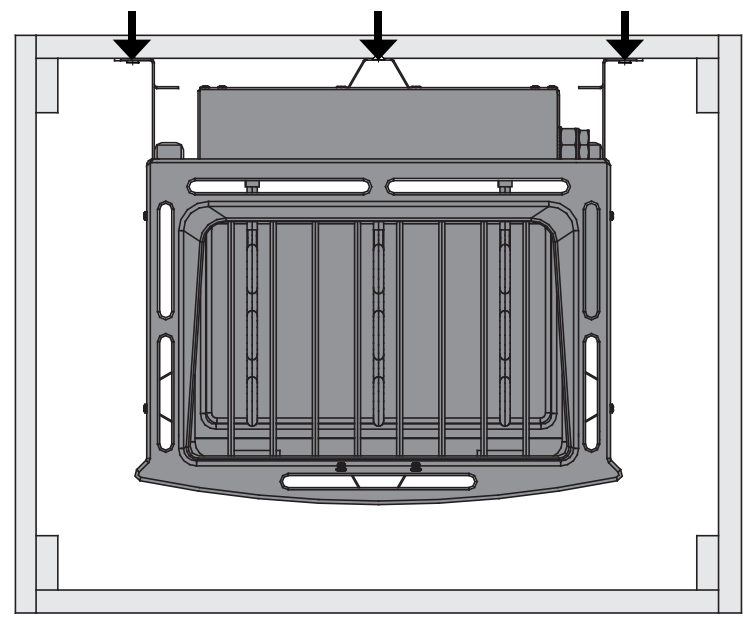

-  Ofenbefestigung
-  oven fixing
-  fixation four
-  oven vaststelling
-  ovn fastsættelse
-  fijación horno
-  fissaggio forno
-  upevňovací trouba
-  Montáža peči

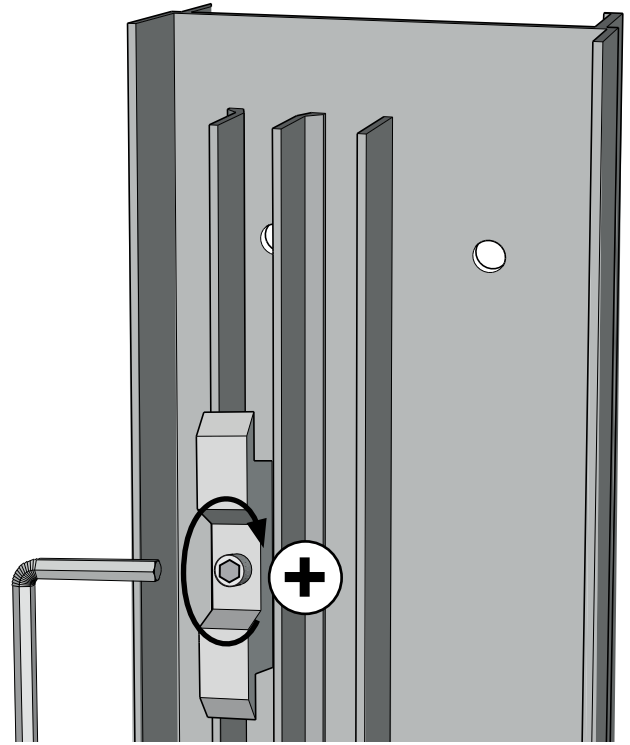
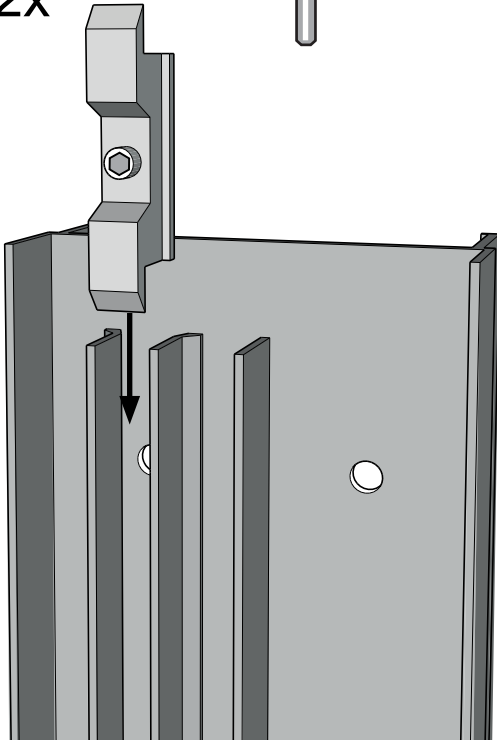
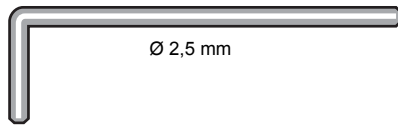

45

2x



46

16x  4,8x32

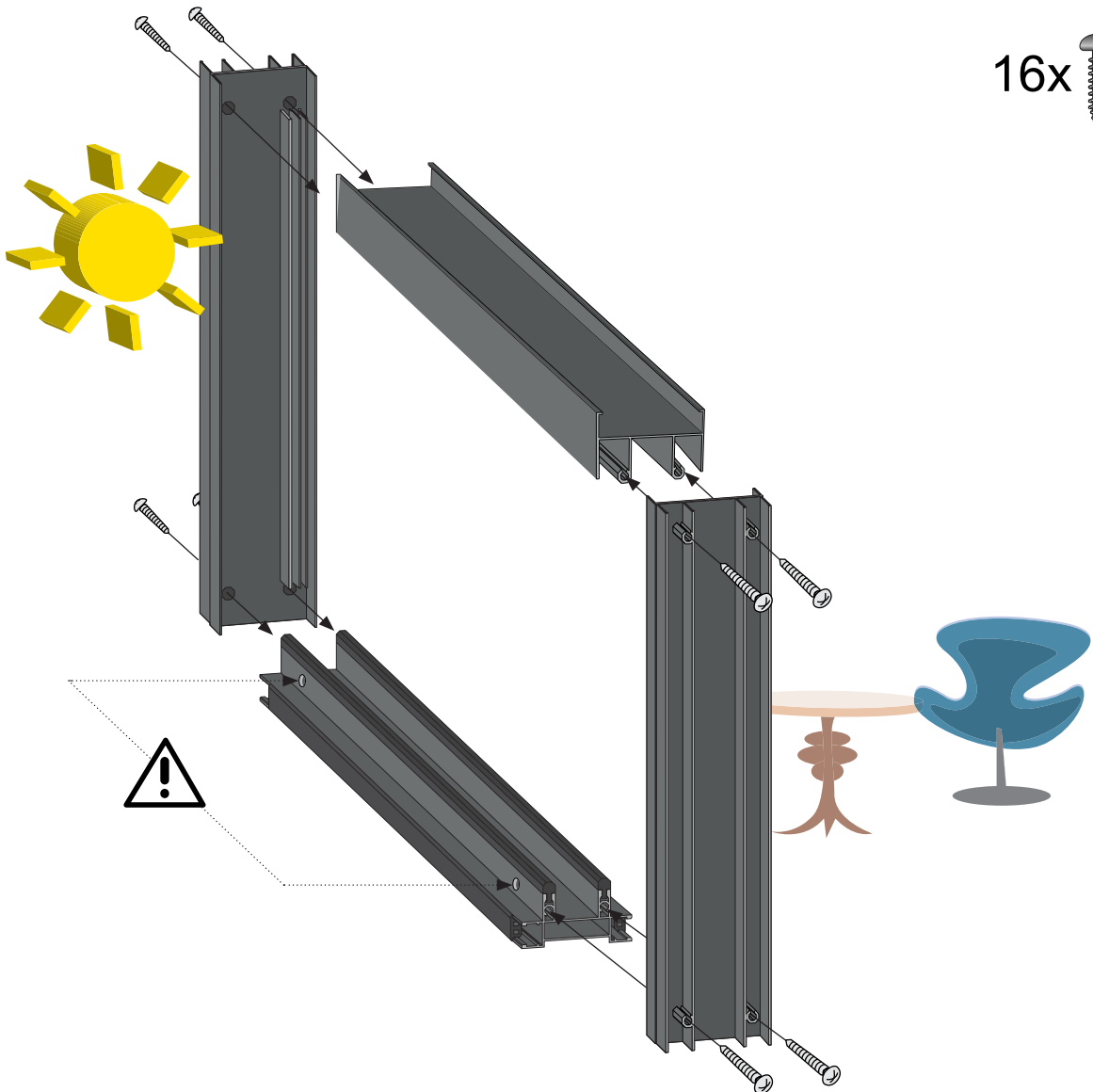

Ø4mm 4,2×50  
6x

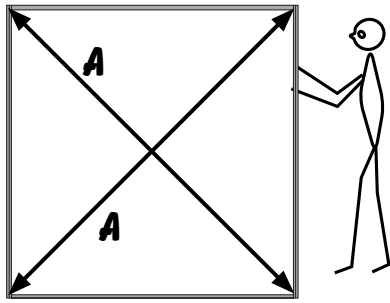
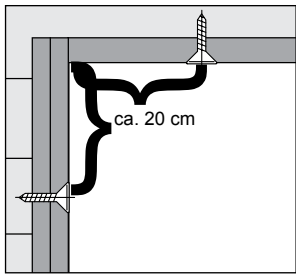

A=A

B 16

B 16

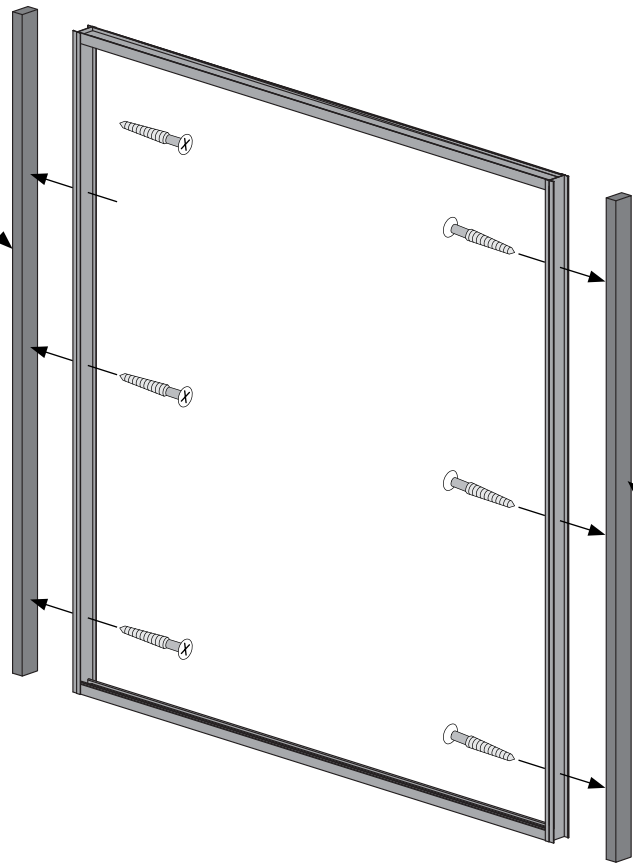

Ø4mm 4,2×50  
4x

Ø7 mm 8×100  
8x

Ø4mm 4,2×50  
4x

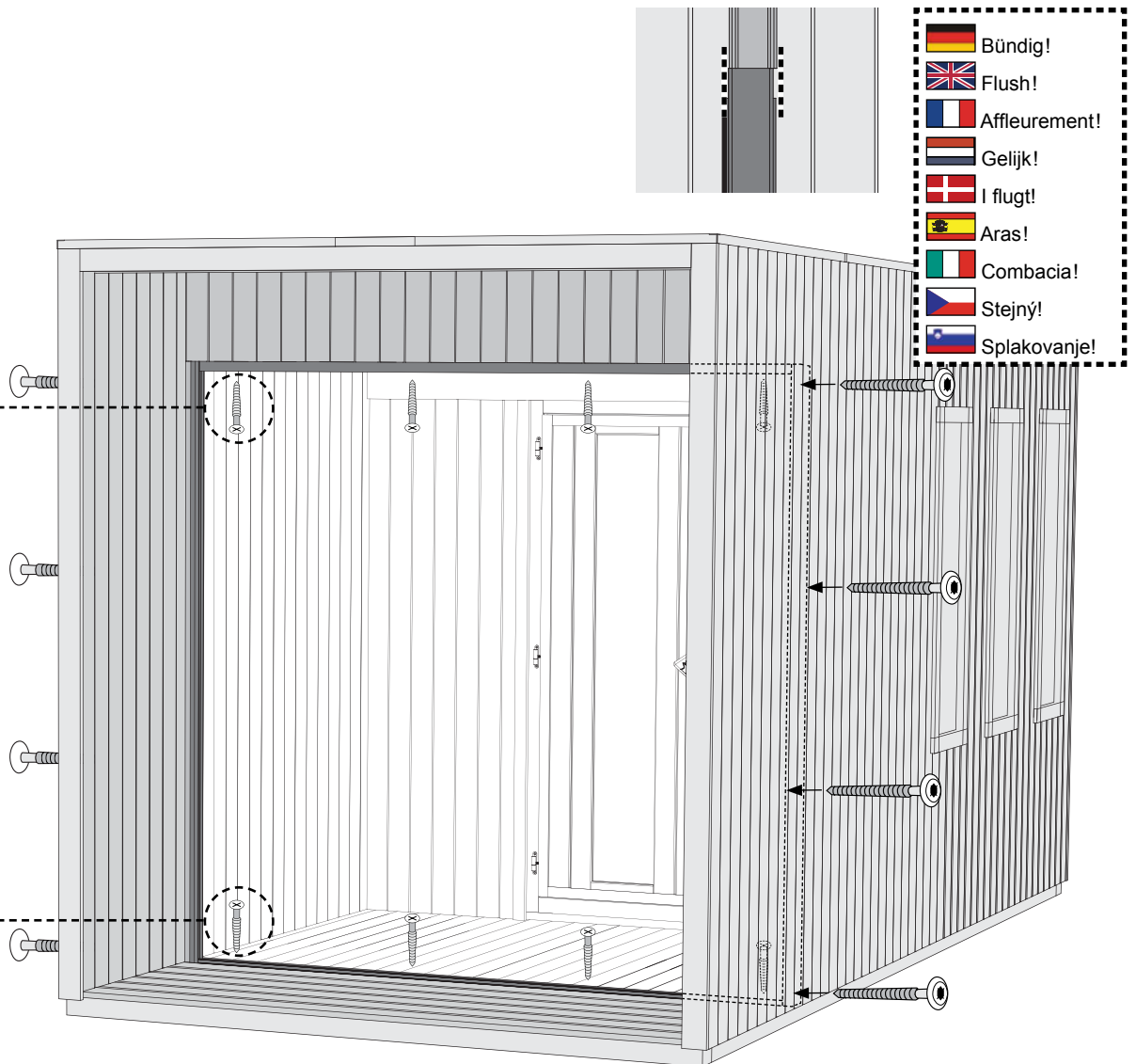

-  Bündig!
-  Flush!
-  Affleurement!
-  Gelijk!
-  I flugt!
-  Aras!
-  Combacia!
-  Stejný!
-  Splakovanje!

