

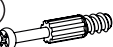











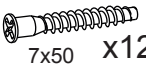



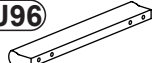

- B1**  ϕ 8x28 x16
- T1**  x4
- M1**  x4
- C2**  ϕ 20 x10
- W1**  x8
- K1**  7x50 x12
- F1**  x10
- P2**  3x16 x16
- J23**  x12

- F7**  x2
- S3**  3,5x13 x2

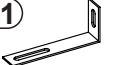
- F10**  x5
- P17**  4x20 x5

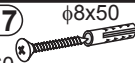
- U96**  x2
- P5**  4x30 x4

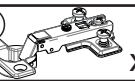

- J11**  x1
- P13**  3,5x13 x2
- T17**  ϕ 8x50 5x60 x1

- Y0**  KR0 x6
- S8**  4x13 x12

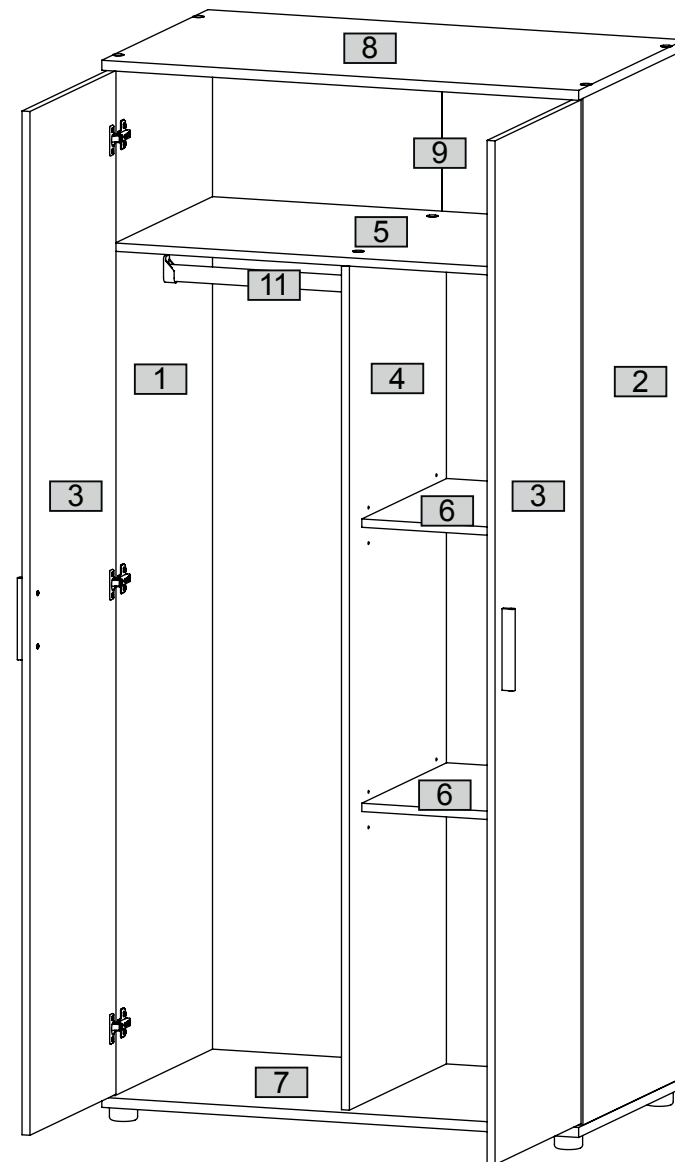
Nr	Ausmaß			St	Colli
1	1850	525	15	1	1
2	1850	525	15	1	1
3	1844	446	15	2	1
4	1520	503	15	1	1
5	868	504	15	1	2
6	426	440	15	2	2
7	900	550	18	1	2
8	900	550	18	1	2
9	1864	441	2	2	1
11	418			1	2



1

F7		x2
S3		x2
		3,5x13

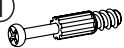
T1		x4
-----------	---	----

B1		ϕ 8x28 x12
-----------	---	-----------------

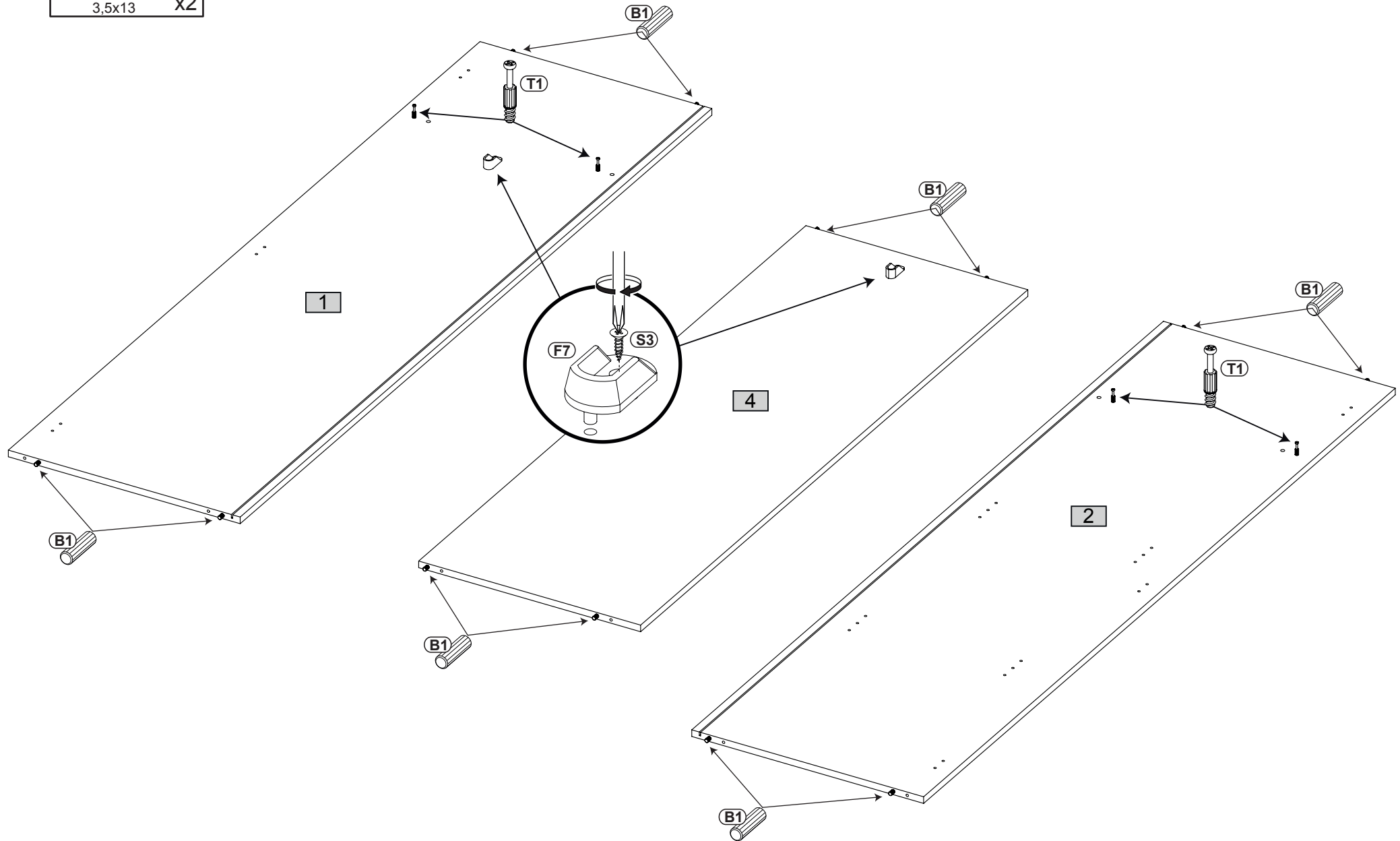

2

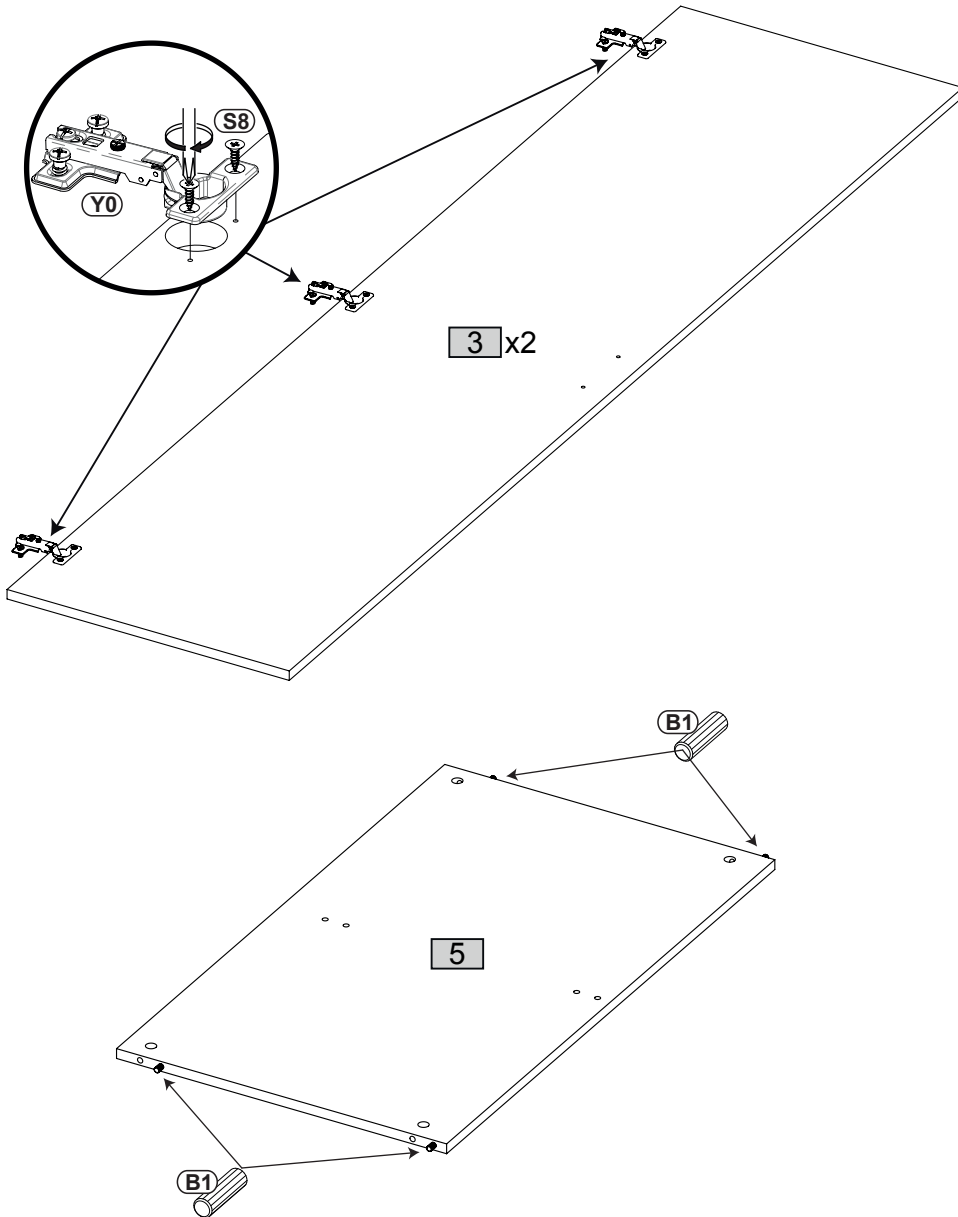
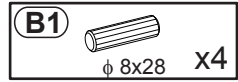
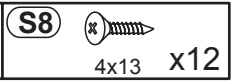
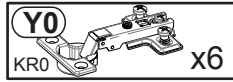

3

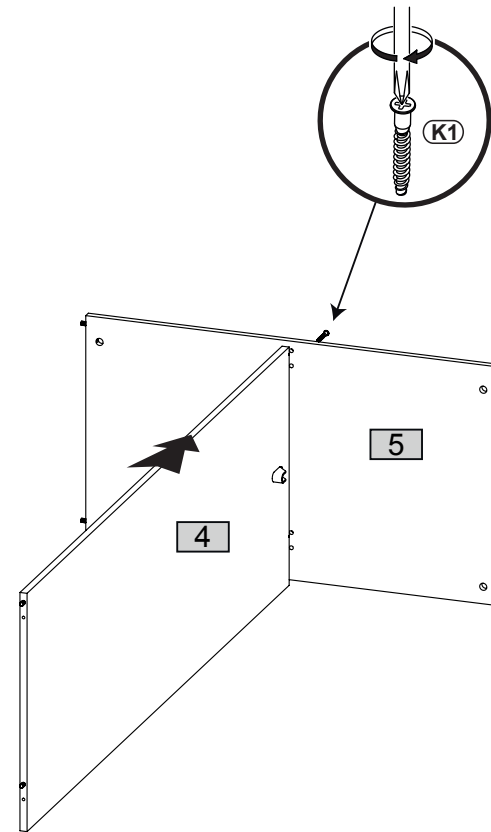
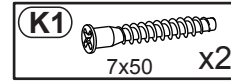

4

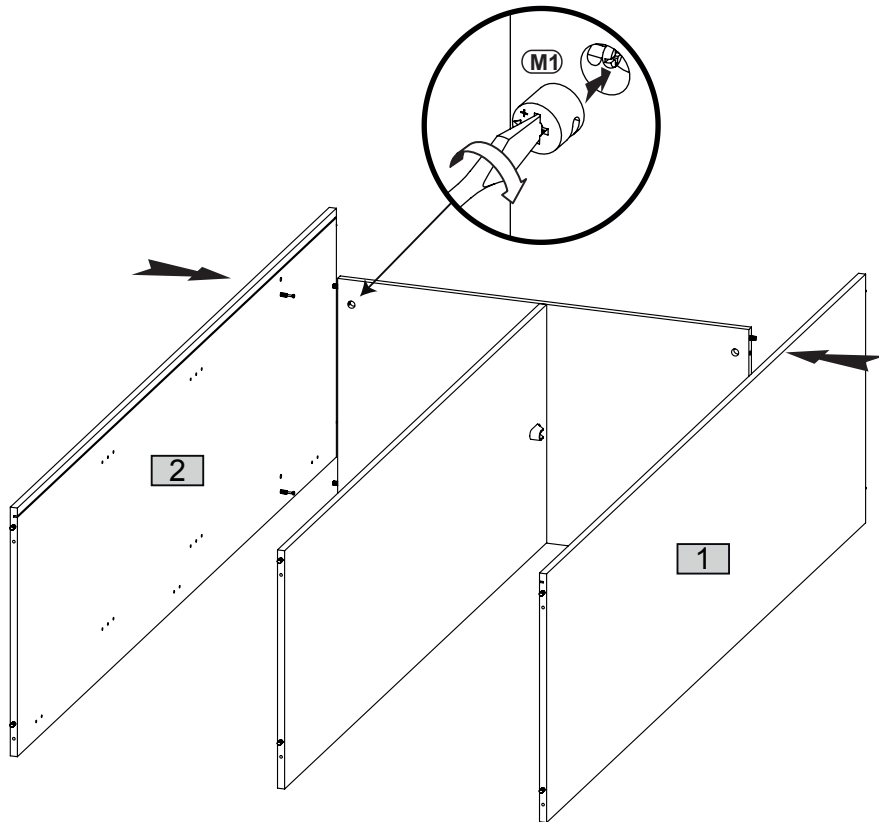

5

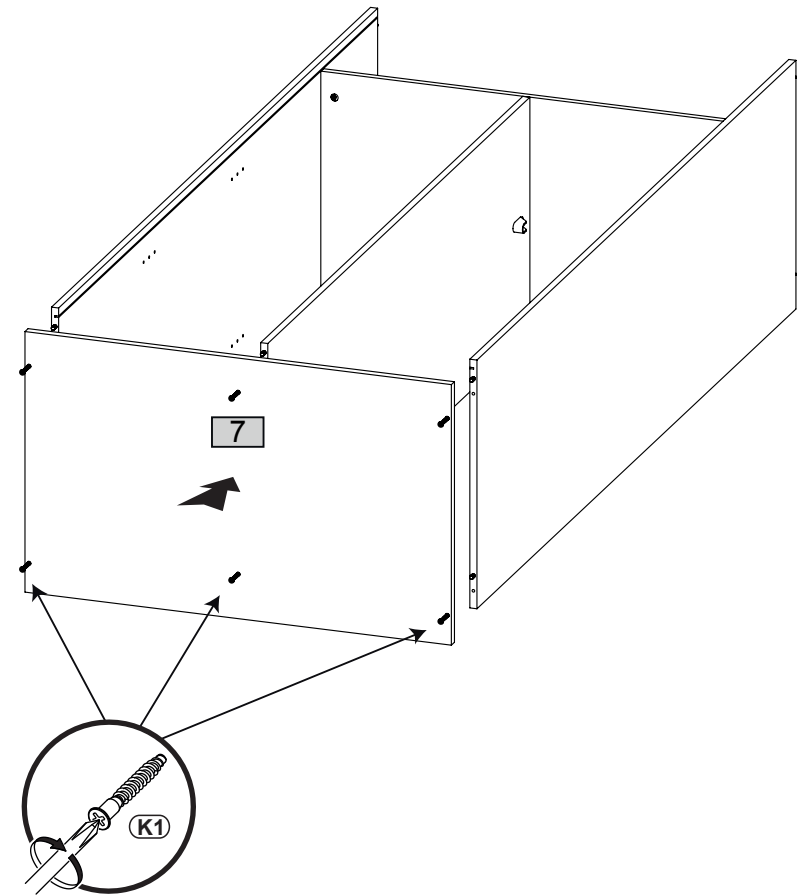
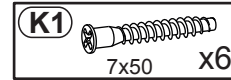

6

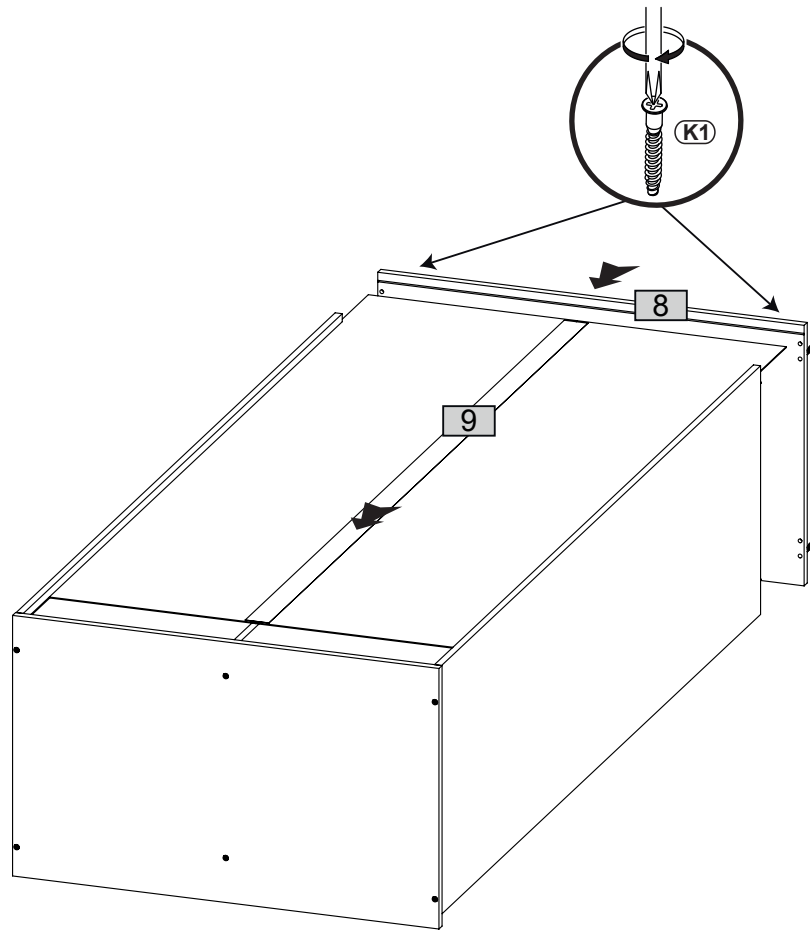
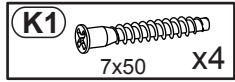

7

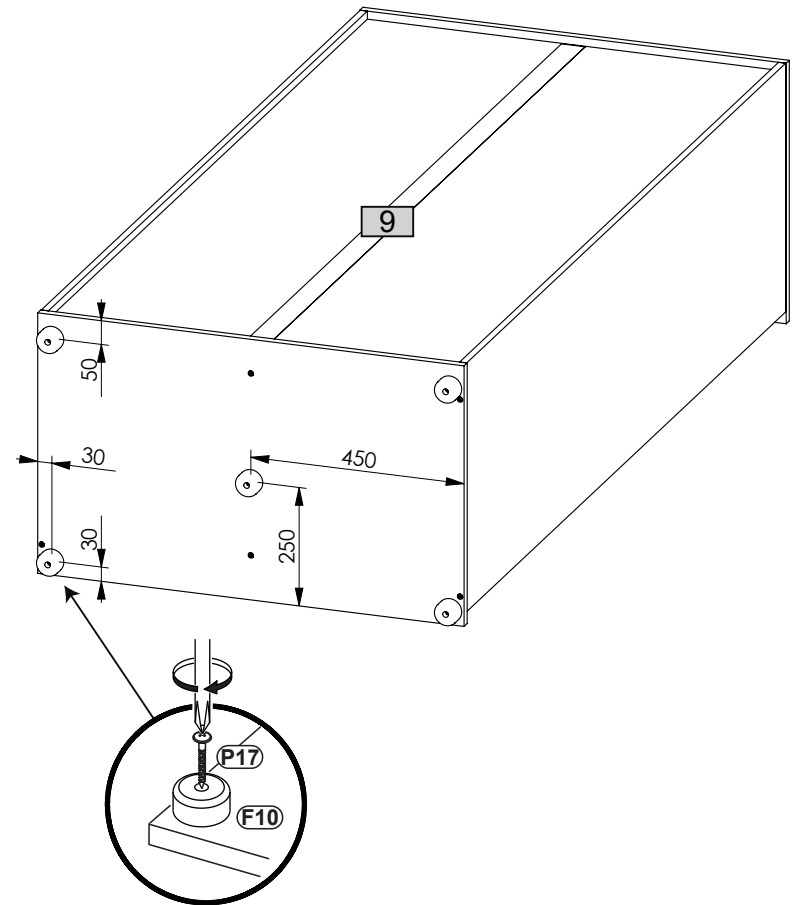
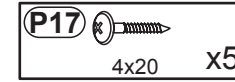
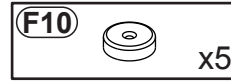

8

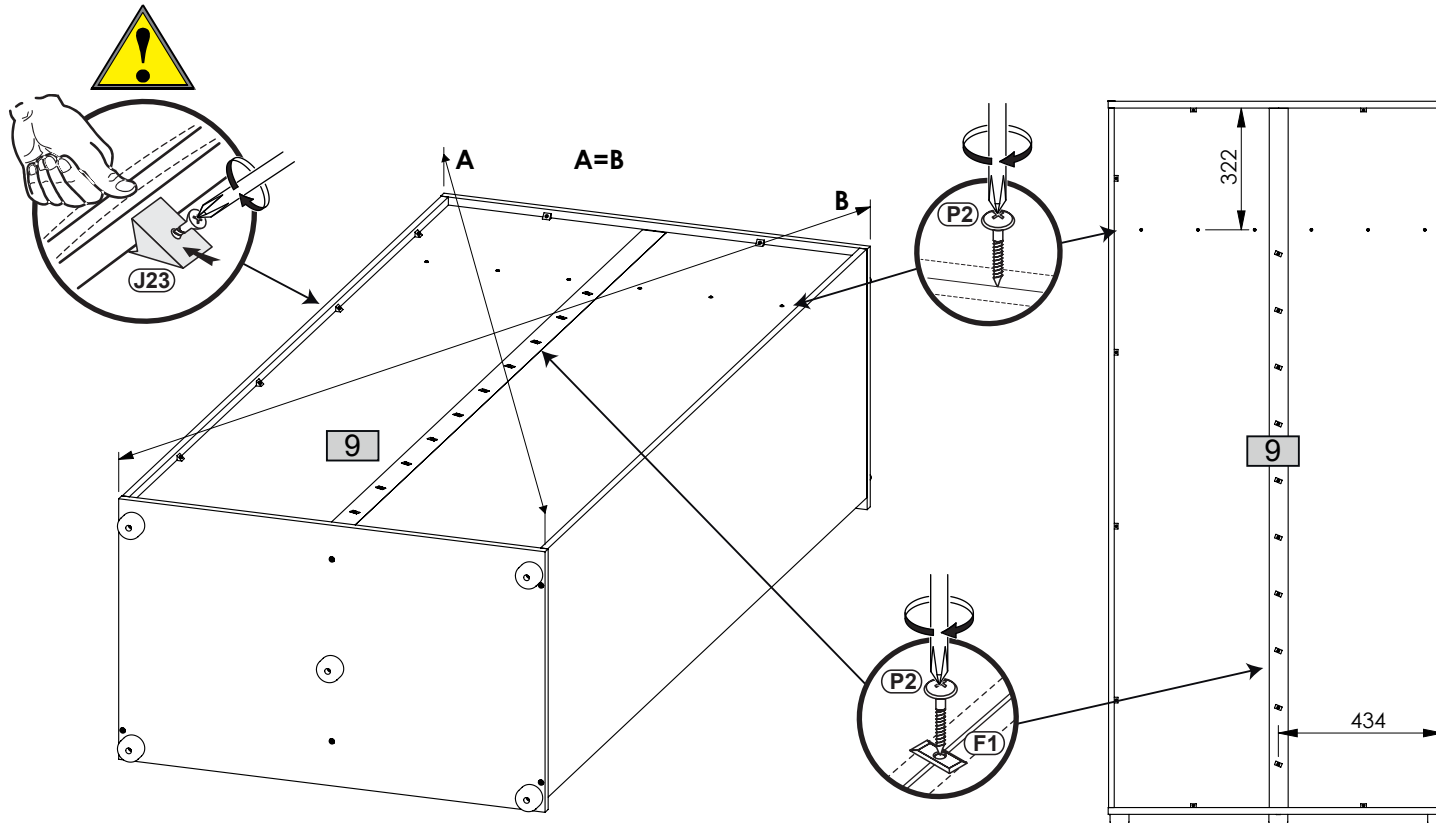
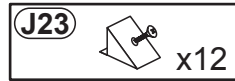
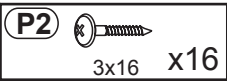

9

