



D Montageanleitung

F Notice de montage

NL Handleiding voor de montage

CZ Monzážní návod

HU Szerelési útmutató

TR Montaj talimatı

GB Assembly instructions

I Istruzione di montaggio

PL Instrukcja montaży

SK Návod na montáž

RO Instrucțiuni de montaj

RU ИНСТРУКЦИЯ ПО МОНТАЖУ

Art. Nr. 1031

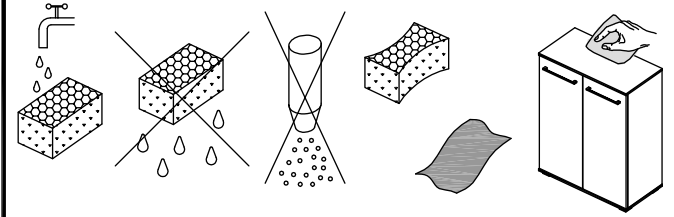
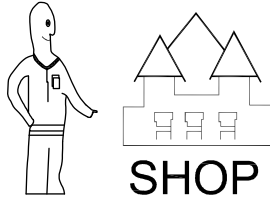
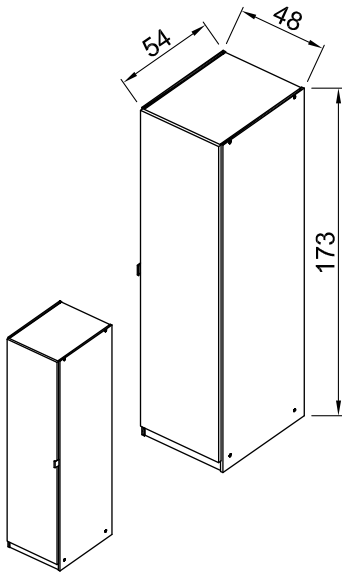

Art. Nr. 1031

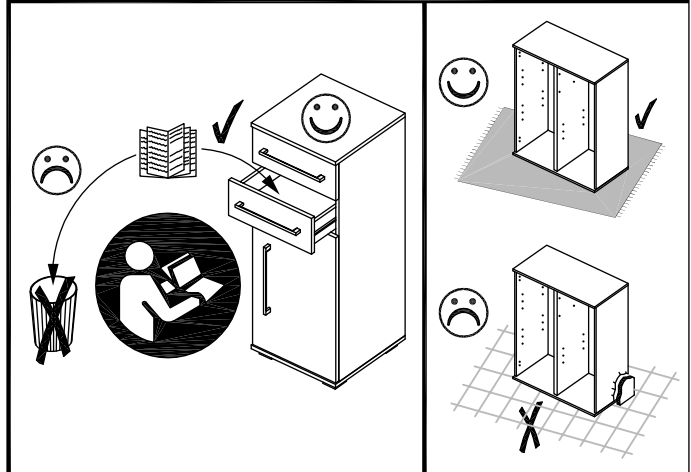
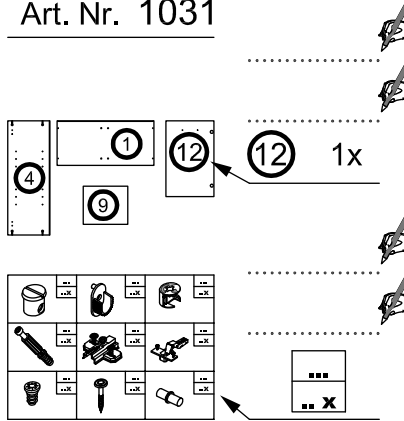

	62 2x		155 3x
3,5 x 13			222 8x
	158 3x		222 8x
		4,5 x 55	
	299 1x		902 2x
436 mm		3,5 x 40	
	901 2x		903 8x
Ø 6 x 25			
	905 8x		908 2x
Ø 12 / 2,5			
	916 4x		921 4x
	927 4x		928 2x
6,3 x 11		4 x 15	
			575 1x

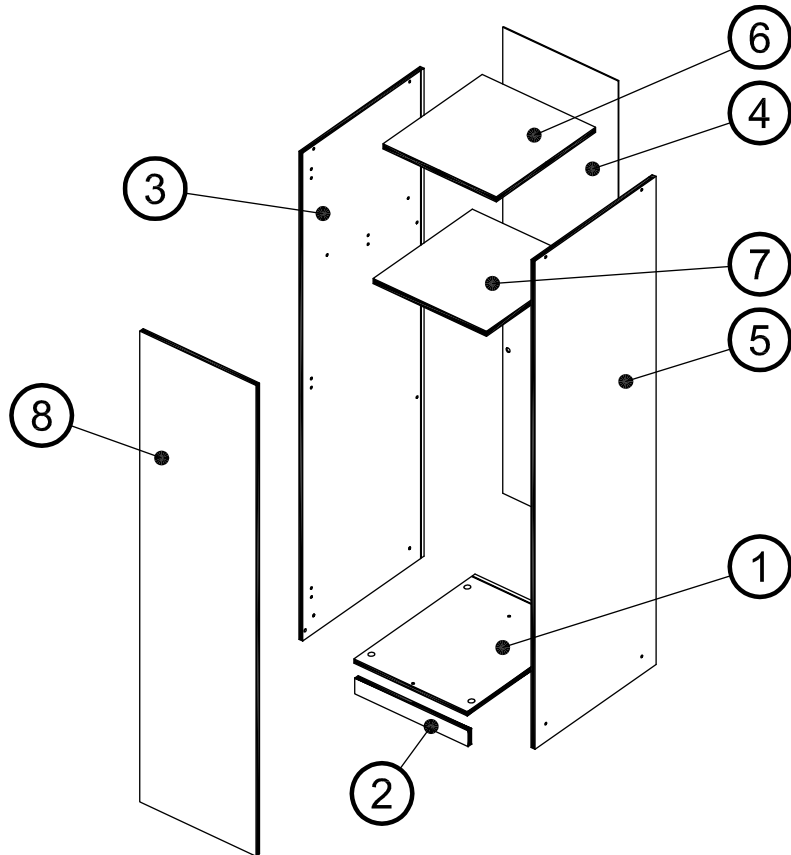

1

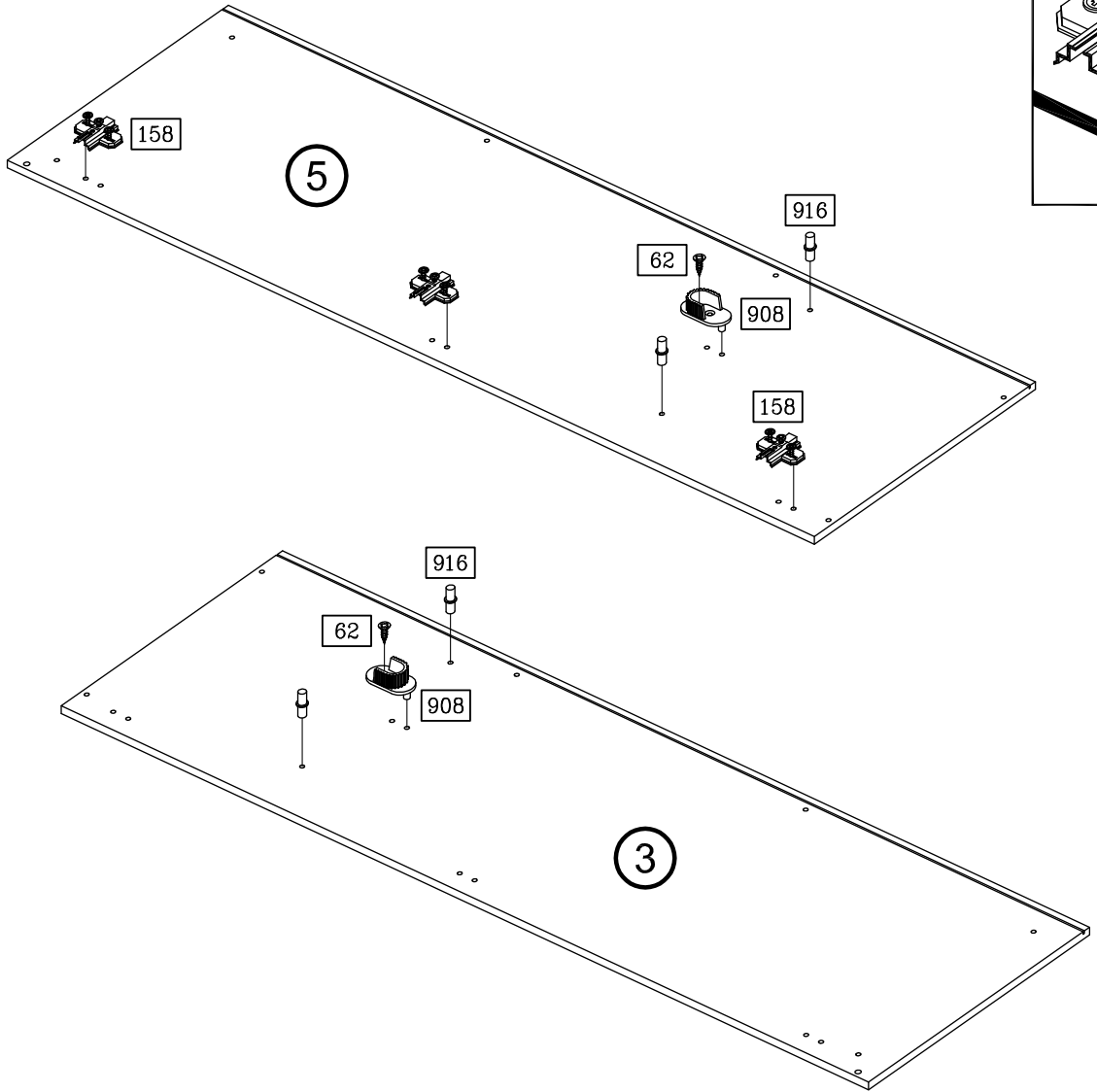
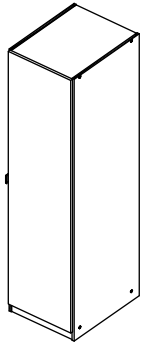

2

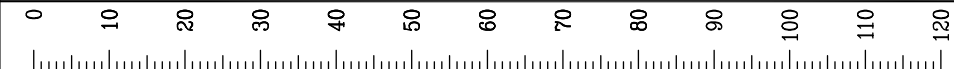
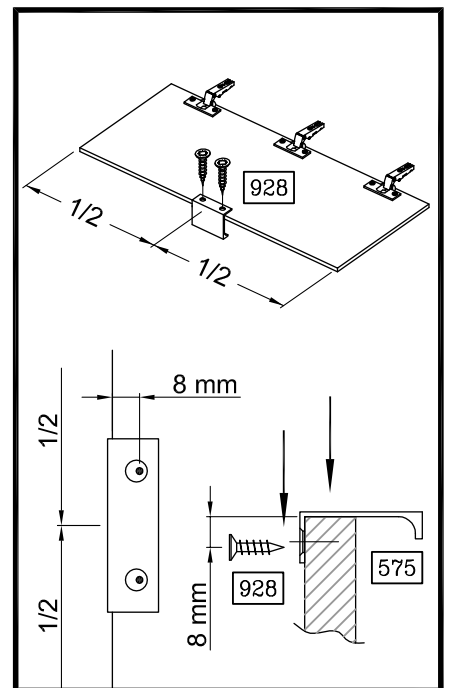
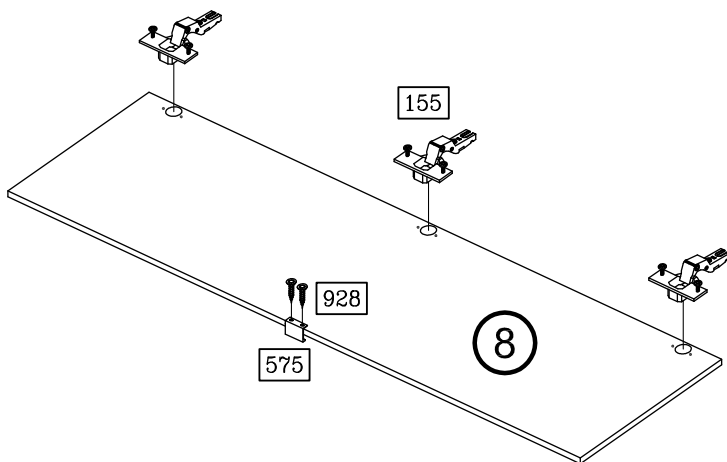

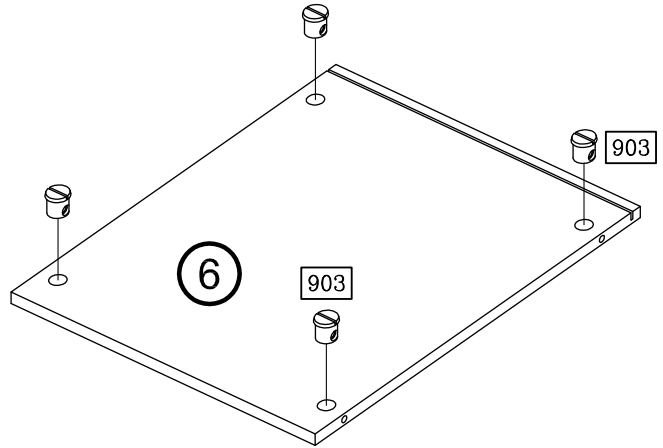
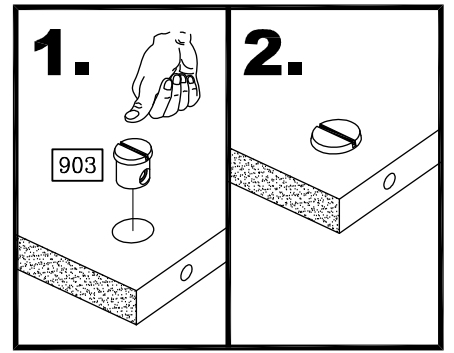
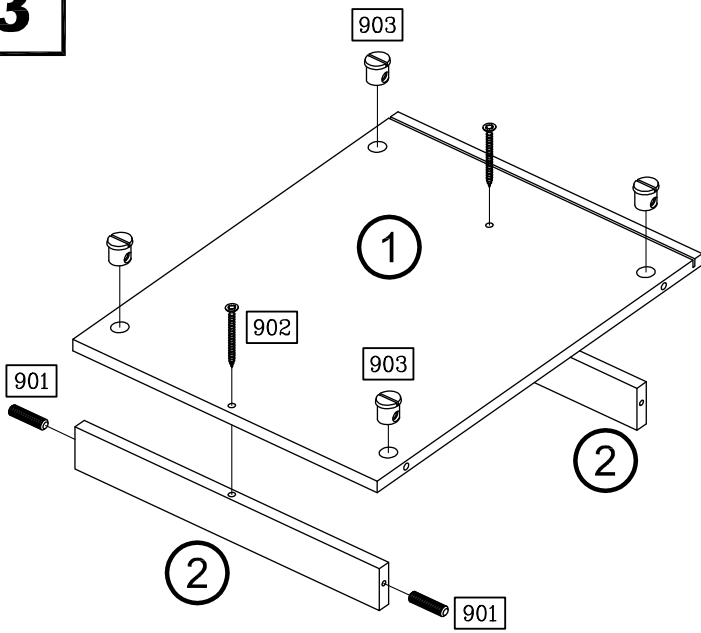
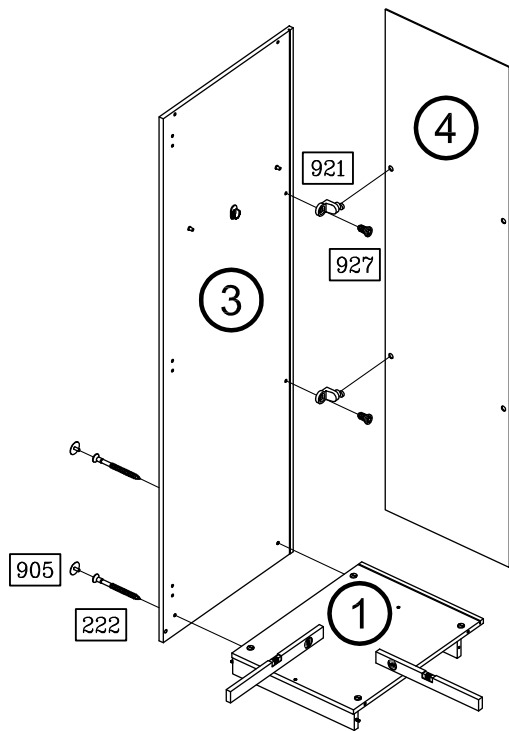
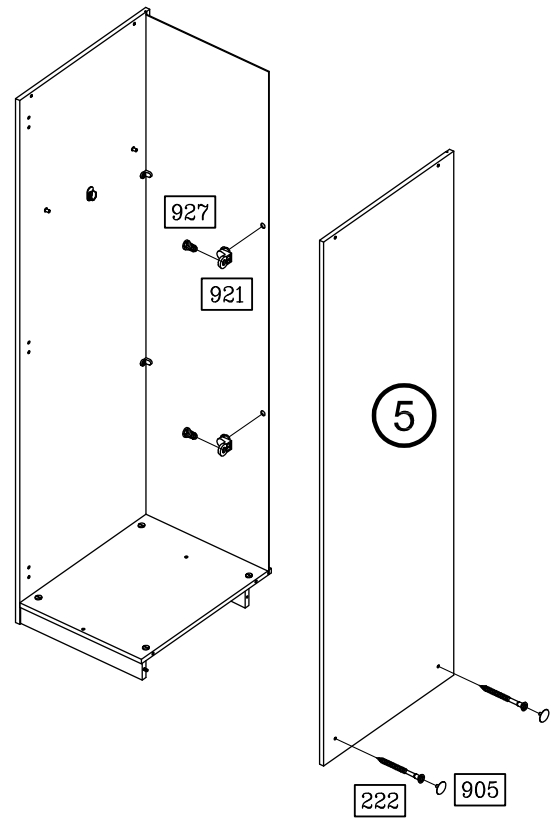
3**4****5**

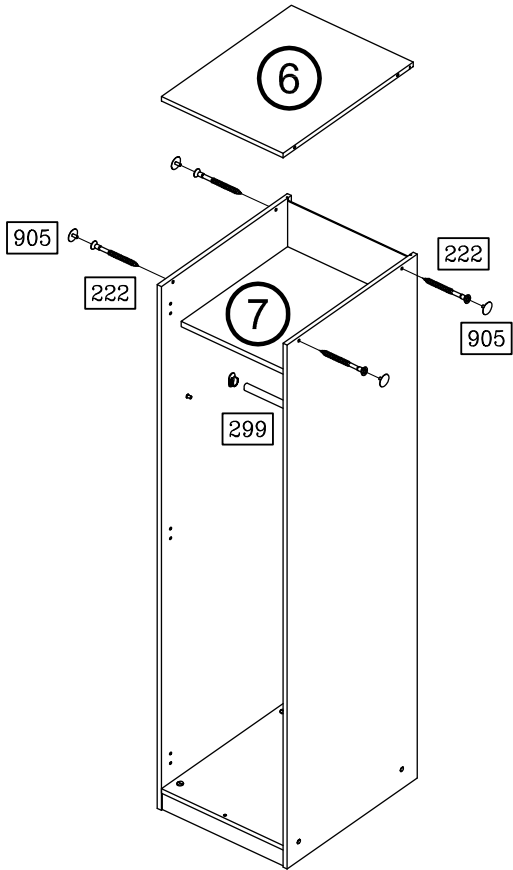
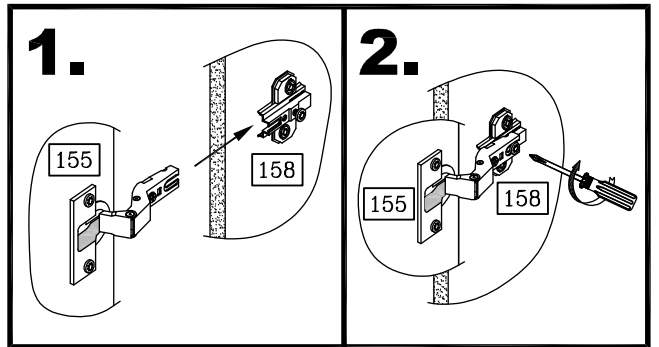
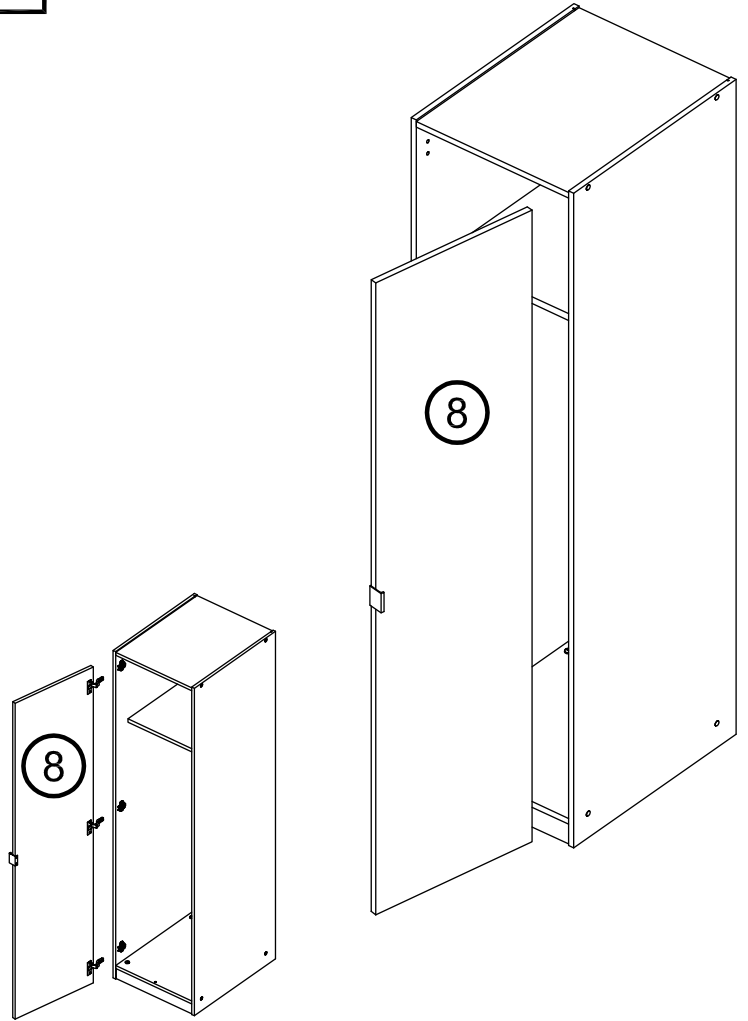
6**7****8**