

**POR FAVOR LEA ATENTAMENTE EL MANUAL ANTES DE UTILIZAR ESTE PRODUCTO  
/ PLEASE READ THIS MANUAL CAREFULLY BEFORE USING THIS PRODUCT  
/ BITTE DIESES HANDBUCH VOR DER ANWENDUNG DES PRODUKTS DURCHLESEN**

---

**INSTRUCCIONES DE MONTAJE / ASSEMBLY INSTRUCTION / MONTAGEANLEITUNG  
SILLA DE OFICINA TIPO GERENCIAL / MANAGERIAL OFFICE CHAIR / CHEFSSEL  
BÜROSTUHL**

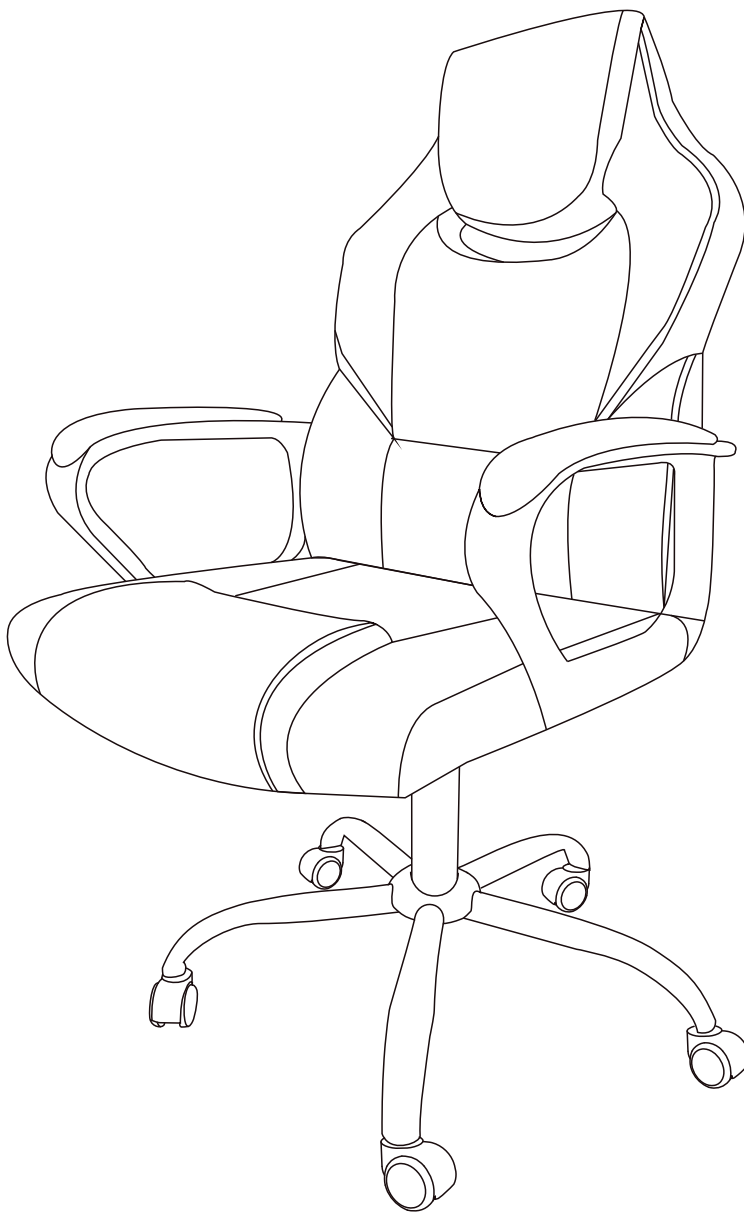

**VIDEOTUTORIAL /  
VIDEOANLEITUNG**

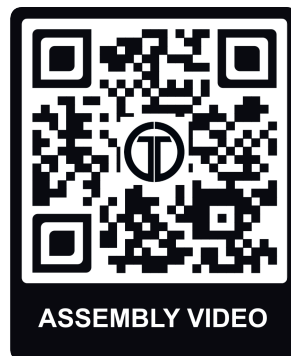

  
**TITANO**

**HECHO EN CHINA / MADE IN CHINA / IN CHINA HERGESTELLT**

---







IMPORTADO EN MEXICO POR  
/ IMPORTED IN MEXICO BY:  
Imporey Internacional, S.A. de C.V.  
Lázaro Cárdenas 670 Col. Zapata  
Monterrey, Nuevo León, México  
C.P. 64390  
Tels. (81) 1365.2821 y 22  
R.F.C. IIN010919756

IMPORTED IN USA BY:  
Comer Trade & Re, Inc.  
2216 PADRE BLVD PB 116  
South Padre Island, TX, 78597  
USA

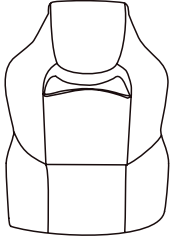
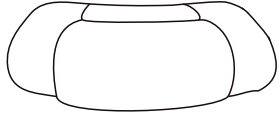
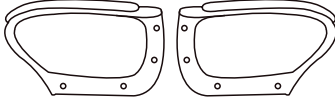
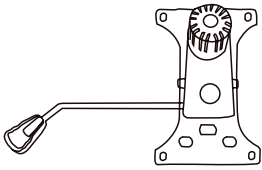
IMPORTIERT IN DEUTSCHLAND DURCH:  
Will Market UG (haftungsbeschränkt)  
Hinter der Ahrend 51  
27607 Geestland  
Deutschland

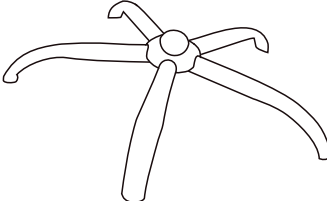
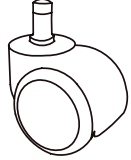
MARCA / BRAND / MARKE: TITANO  
MODELO / MODEL / MODELL:  
TT-SOTGRBK

**PIEZAS / PIECES / BAUTEILE**

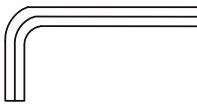
		
<p><b>A</b>      <b>x1</b></p>	<p><b>B</b>      <b>x1</b></p>	<p><b>C</b>      <b>x2</b></p>
		
<p><b>D</b>      <b>x1</b></p>	<p><b>E</b>      <b>x1</b></p>	<p><b>F</b>      <b>x1</b></p>
		
<p><b>G</b>      <b>x1</b></p>	<p><b>H</b>      <b>x5</b></p>	<p><b>I</b>      <b>x8</b></p>
 <p><b>M6x 25mm</b></p>	 <p><b>M6x 20mm</b></p>	
<p><b>J</b>      <b>x8</b></p>	<p><b>K</b>      <b>x4</b></p>	<p><b>L</b>      <b>x1</b></p>

## INSTRUCCIONES DE MONTAJE / ASSEMBLY INSTRUCTIONS / MONTAGEANLEITUNG

- 1) 1.1) Posicione la **pieza D** por debajo del **asiento B** como se muestra en la imagen  
/ Position **part D** under the **seat B** as shown in the image  
/ **Teil D** gemäß der Abbildung unter den **Sitz B** einsetzen

Utilice la **pieza L** para fijar los tornillos  
/ Use the **L piece** to fix the screws  
/ Schrauben mit Teil **L** befestigen.



- 1.2) Fije la **pieza D** enroscando los **tornillos K (x4)** en las perforaciones indicadas de la **pieza B**  
/ Fix **part D** by screwing the **screws K (x4)** into the indicated holes of **part B**  
/ Um das **Teil D** zu befestigen, **Schrauben K (x4)** in die markierten Löcher des **Teils B** einschrauben

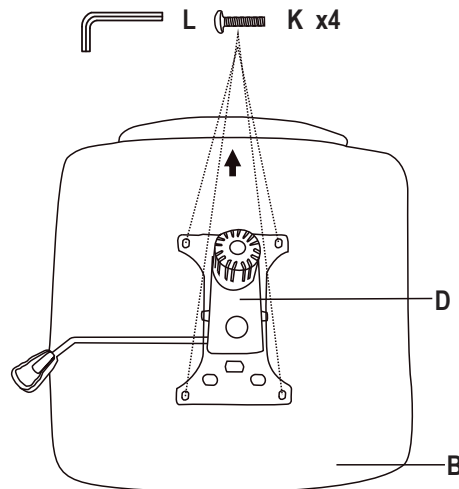

- 2) 2.1) Posicione los **descansa brazos C (x2)** uniendo las **piezas A y B** como se muestra en la imagen  
/ Position the **armrests C (x2)** joining **parts A and B** as shown in the image  
/ **Armlehnen C (x2)** gemäß der Abbildung einsetzen, um die **Teile A und B** zu verbinden

- 2.2) Fije los **descansa brazos C (x2)** enroscando los **tornillos J (x8)** en las perforaciones indicadas  
/ Secure **armrests C (x2)** by screwing the **J screws (x8)** into the indicated holes.  
/ Um die **Armlehnen C (x2)** zu befestigen, **Schrauben J (x8)** in die markierten Löcher einschrauben

- 2.3) Cubrir **tornillos J (x8)** con **piezas I (x8)**  
/ Cover **screws J (x8)** with **pieces I (x8)**  
/ **Schrauben J (x8)** mit **Teile I (x8)** abdecken

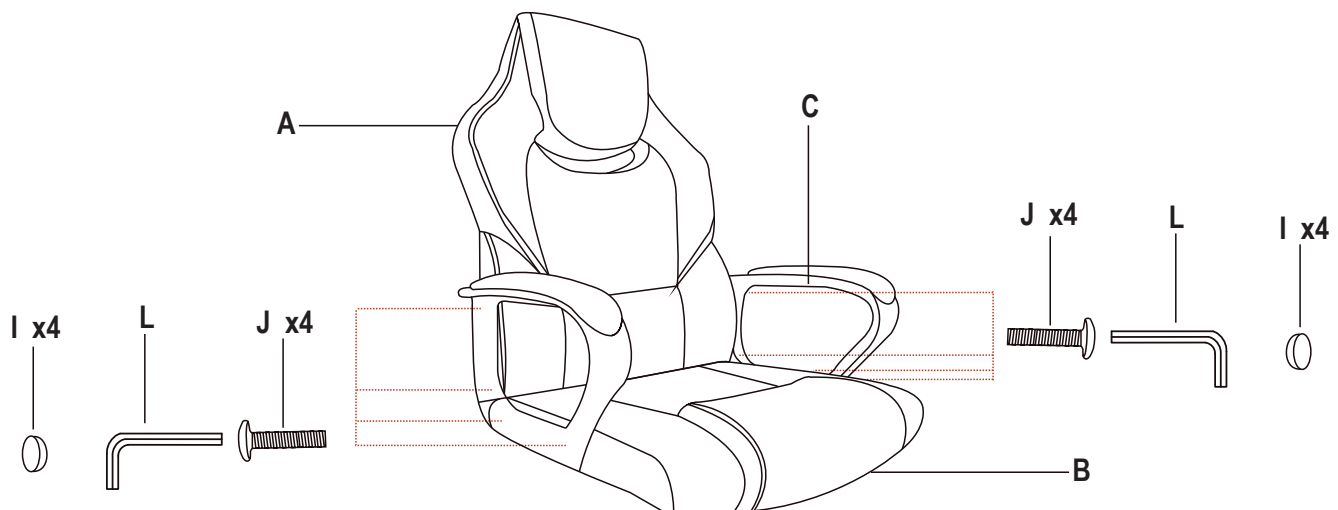

## INSTRUCCIONES DE MONTAJE / ASSEMBLY INSTRUCTIONS / MONTAGEANLEITUNG

- 3 3.1) Inserte las **ruedas H (x5)** en cada pata de la **pieza G**  
/ Insert the **wheels H (x5)** in each leg of the **part G**  
/ **Räder H (x5)** in jedes Bein des **Teils G** einsetzen

3.2) Coloque la **pieza E** en la perforación indicada de la **pieza G**  
/ Place **part E** in the indicated hole of **part G**  
/ **Teil E** in das angegebene Loch von **Teil G** einsetzen

3.3) Coloque la **pieza F** sobre la **pieza G**  
/ Place **part F** on top of **part G**  
/ **Teil F** auf **Teil G** setzen

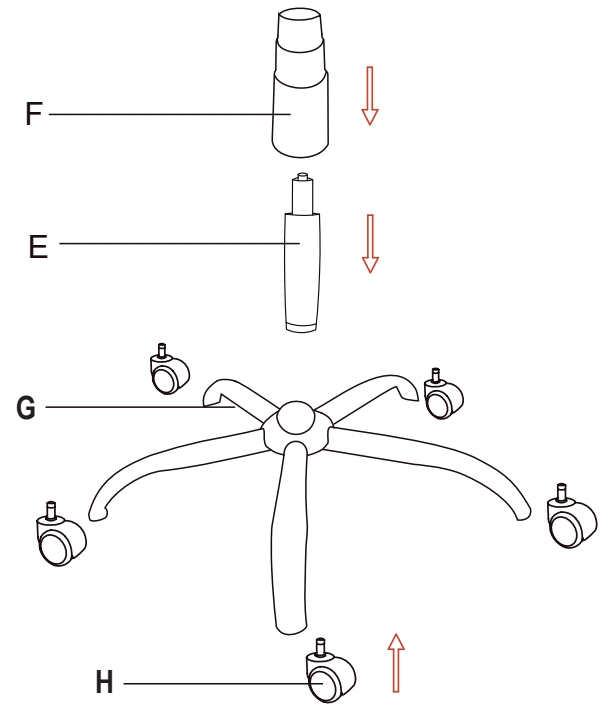

- 4 4.1) Inserte la silla ensamblada en la base como se muestra en la imagen  
/ Insert the assembled chair into the base as shown in the picture  
/ Zusammengebauten Stuhl in den Stuhlsockel gemäß der Abbildung einsetzen

- 5 5.1) Instalación completa  
/ Installation complete  
/ Montage abgeschlossen

