

MONTAGEANLEITUNG

Artike lnummer: WF318719
WF318720
WF318721
WF318722

Dieses Set ist in 4 Boxen enthalten. Wenn Sie keine vollen 4 Boxen erhalten, wenden Sie sich bitte an unseren Kun denservice

This set comes in 4-boxes If you do not receive a full 4-boxes, please contact our customer service.

Etagenbett Weiß 200x90cm

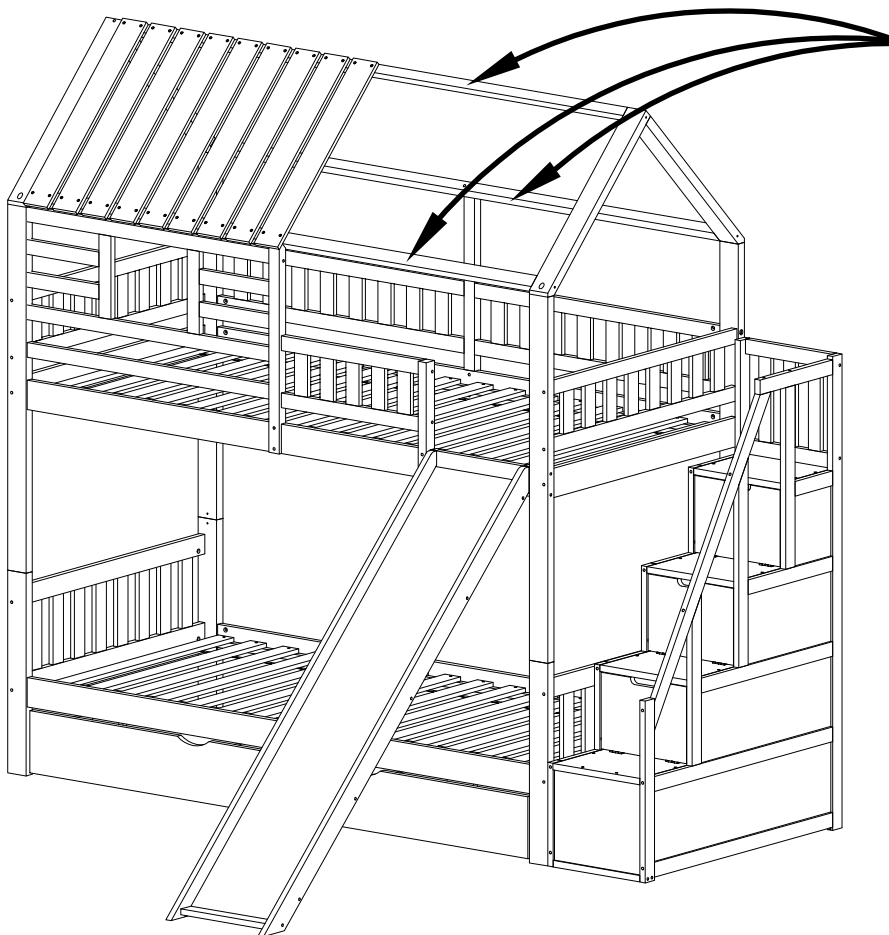

ATTENTION !
NE PAS LAISSER LES
ENFANTS SE
SUSPENDRE
AUX BARRES!

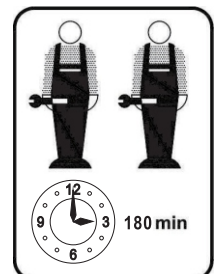

INSTRUCTIONS

IMPORTANT-READ CAREFULLY-RETAIN FOR FUTURE REFERENCE

- a) **WARNING**-High beds and the upper bed of bunk beds are not suitable for children under six years due to the risk of injury from falls;
- b) **WARNING**-Bunk beds and high beds can present a serious risk of injury from strangulation if not used correctly. Never attach or hang items to any part of the bunk bed that are not designed to be used with the bed, for example, but not limited to ropes, strings, cords, hooks, belts and bags.
- c) **WARNING**-Children can become trapped between the bed and the wall, a roof pitch, the ceiling adjoining pieces of furniture (e.g. cupboards) and the like. To avoid risk of serious injury the distance between the top safety barrier and the adjoining structure shall not exceed 75 mm or shall be more than 230 mm.
- d) **WARNING**-Do not use the bunk bed/high bed if any structural part is broken or missing; Replacement parts are between requested from the manufacturer or the store.
- e) it is imperative to always follow the installation instructions and manufacturer's use.
- f) The recommended size of the mattress to be used with the bed is **90x200cm**, maximum thickness mattress: **13cm**.
- g) It is necessary to ventilate the room in order to maintain a low level moisture and prevent mold growth in the bed and its periphery.
- h) Joining devices should always be tightened properly and regularly verified. Tighten if necessary.











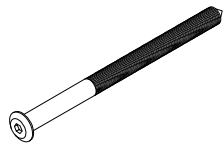

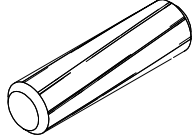
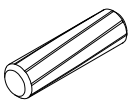
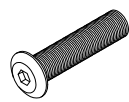

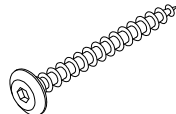
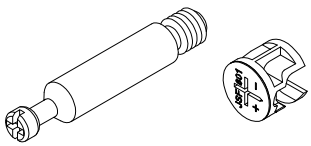
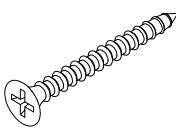
ANLEITUNG

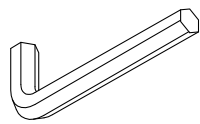
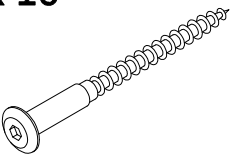
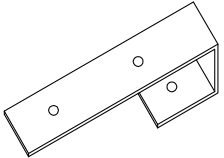
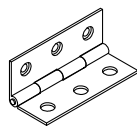
WICHTIG-SORGFÄLTIG DURCHLESEN-FÜR ZUKÜNFTIGE REFERENZ BEWAHREN

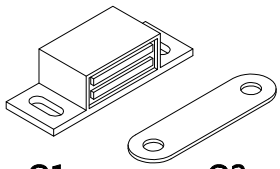
- a) WARNUNG**-Das Oberbett von Etagenbett ist wegen der Verletzungsgefahr durch Stürze nicht für Kinder unter sechs Jahren geeignet.
- b) WARNUNG**-Etagenbetten und Hochbetten können ein ernstes Verletzungsrisiko darstellen, wenn sie nicht ordnungsgemäß verwendet werden. Befestigen oder hängen Sie niemals etwas an einem Teil des Etagenbettes, das nicht für das Bett bestimmt ist, wie z. B. Seile, Haken, Gurte und Taschen.
- c) WARNUNG**-Kinder können zwischen Bett und Wand eingeklemmt werden. Um die Gefahr schwerer Verletzungen zu vermeiden, darf der Abstand zwischen der oberen Sicherheitsbarriere und der angrenzenden Konstruktion 75 mm nicht überschreiten oder mehr als 230 mm betragen.
- d) WARNUNG**-Verwenden Sie das Etagenbett nicht, wenn ein Bauteil beschädigt ist oder fehlt. Ersatzteile werden zwischendurch beim Hersteller oder beim Händler angefordert.
- e)** Befolgen Sie unbedingt die Anweisung des Herstellers.
- f)** Die empfohlene Größe der Matratze für das Bett beträgt **90x200cm**, maximale Dicke der Matratze: **13 cm**.
- g)** Es ist notwendig, den Raum zu lüften, um ein niedriges Feuchtigkeitsniveau aufrechtzuerhalten und das Wachstum von Schimmel im Bett und an dessen Peripherie zu verhindern.
- h)** Verbindungselemente sollten immer richtig angezogen und regelmäßig überprüft werden. Bei Bedarf festziehen.

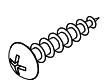
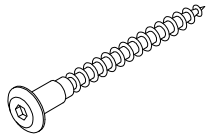
Hardware

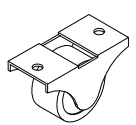
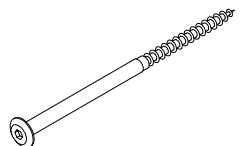
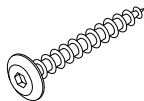
Part List : WF318720

<p>A x 22</p>  <p>M6x70</p>	<p>B x 21</p>  <p>M6x110</p>	<p>C x 44</p>  <p>Φ10x12</p>	<p>D x 4</p>  <p>Φ12x60</p>
<p>E x 149</p>  <p>Φ8x30</p>	<p>F x 2</p>  <p>M6x30</p>	<p>G x 6</p>  <p>M6x20</p>	<p>H x 23</p>  <p>Φ6x50</p>
<p>J x 11</p>  <p>J1 J2</p>	<p>K x 108</p>  <p>Φ4x30</p>	<p>L x 34</p>  <p>Φ3.5x15</p>	<p>M x 2</p> 
<p>N x 16</p>  <p>Φ6x70</p>	<p>O x 2</p> 	<p>P1 x 6</p>  <p>P2 x 36</p>  <p>Φ3x16</p>	<p>Q x 3</p>  <p>Q1 Q2</p>
<p>R x 1</p>  <p>M6x80</p>	<p>S x 8</p>  <p>Φ4x25</p>	<p>T x 7</p>  <p>Φ6x60</p>	<p>W x 36</p>  <p>Φ4x20</p>
<p>V x 8</p> 	<p>U x 6</p>  <p>M6x110</p>	<p>X x 1</p>  <p>Φ6x40</p>	<p>Y x 4</p>  <p>M6x25</p>

ASSEMBLY INSTRUCTIONS

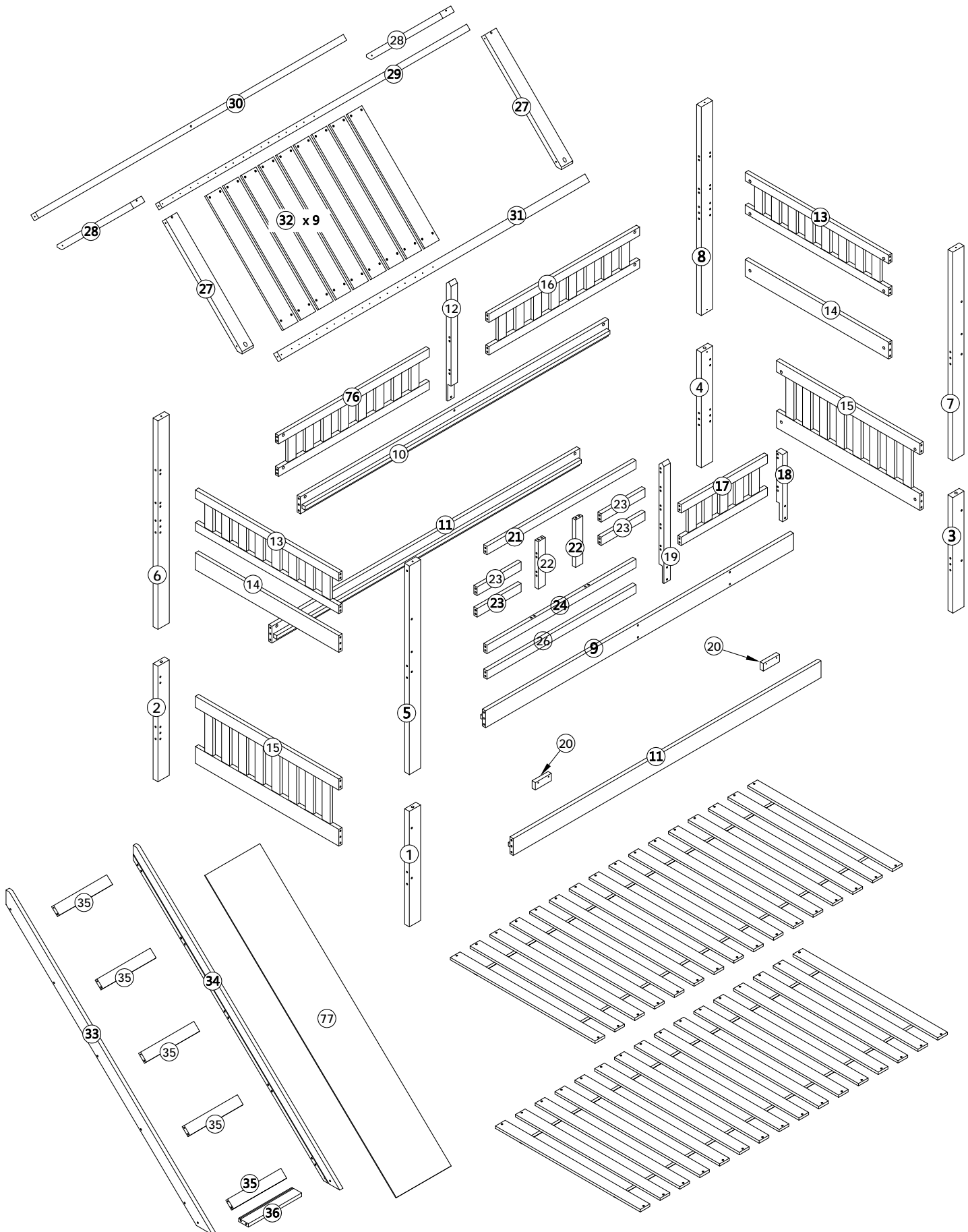

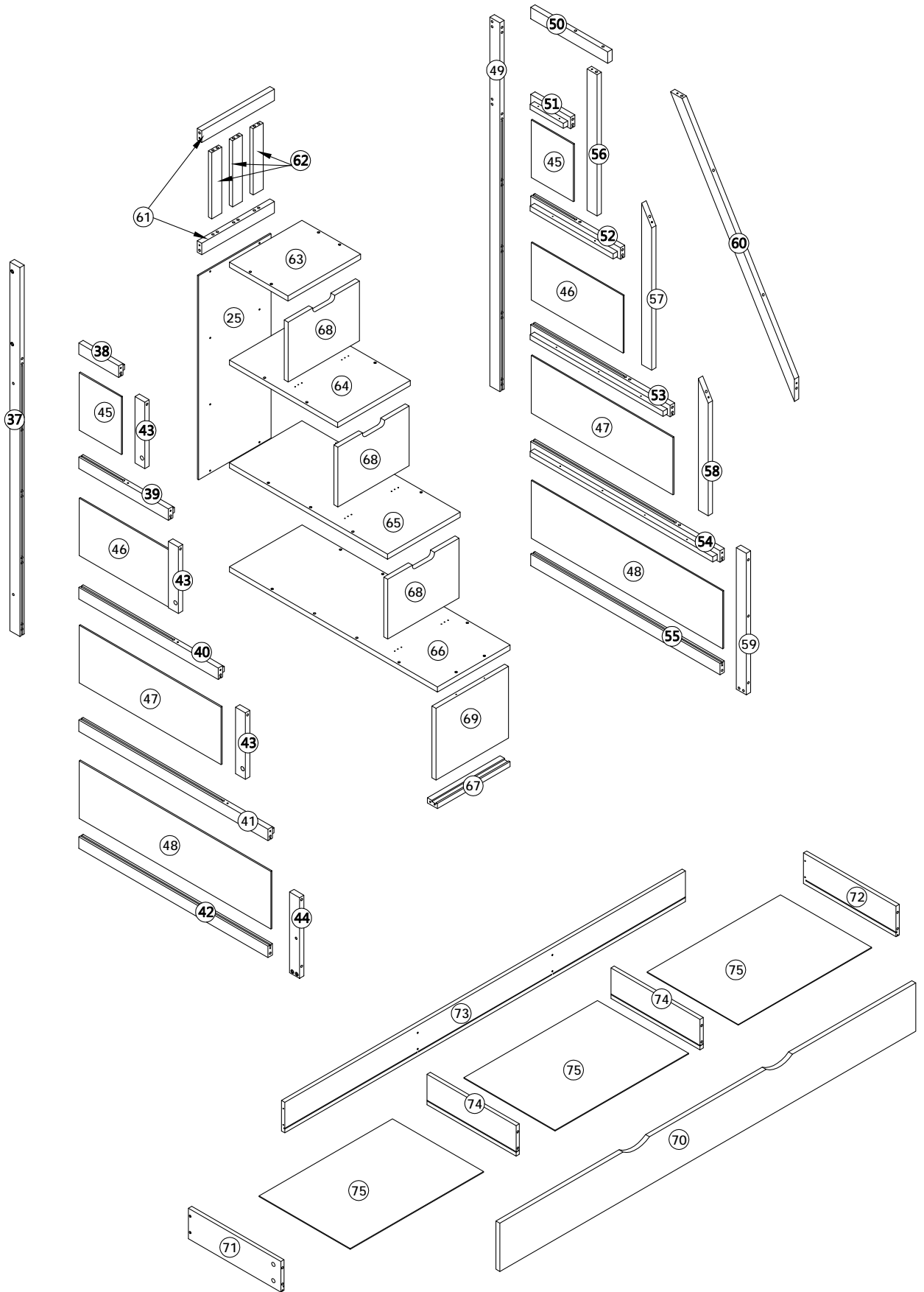

ASSEMBLY INSTRUCTIONS

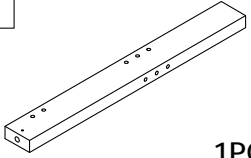
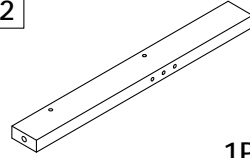
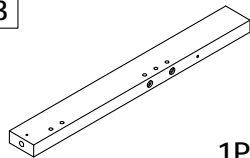
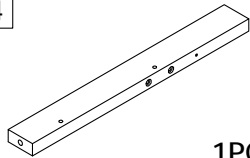
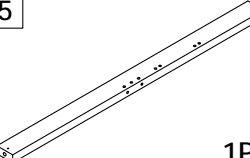
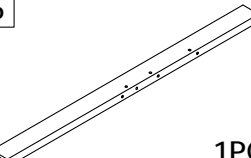
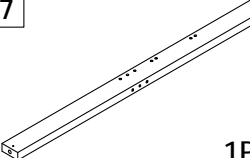
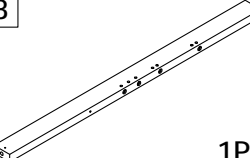
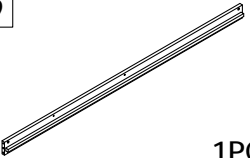
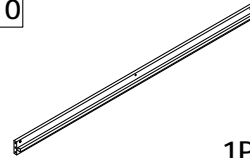
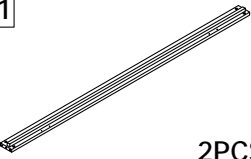
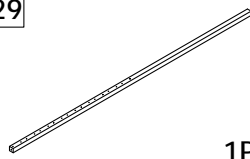
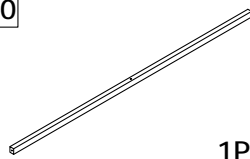
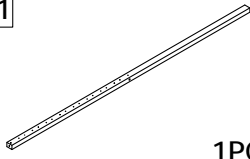
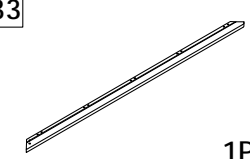
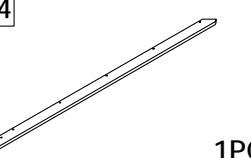
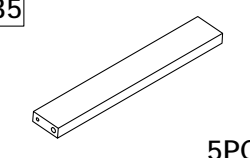

Etagenbett

Part List : WF318719

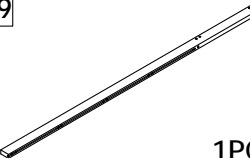
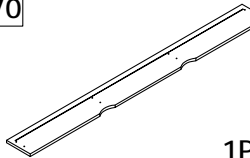
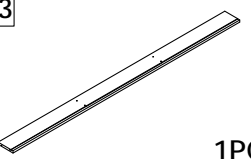
1  1PC	2  1PC	3  1PC	4  1PC	5  1PC
6  1PC	7  1PC	8  1PC	9  1PC	10  1PC
11  2PCS	29  1PC	30  1PC	31  1PC	33  1PC
34  1PC	35  5PCS	37  1PC	49  1PC	70  1PC
73  1PC				

Part List : WF318720

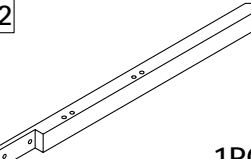
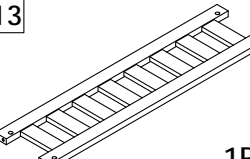
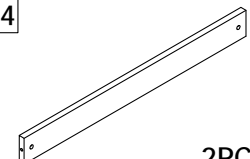
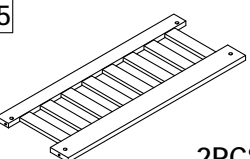
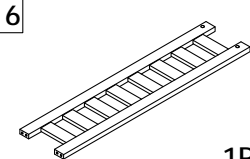
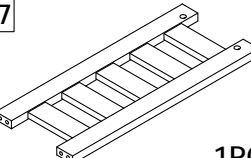
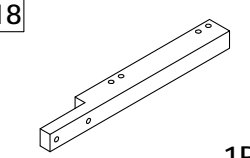
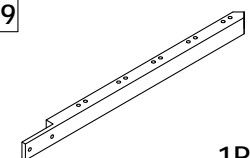
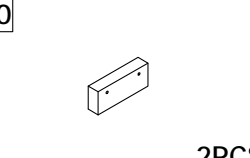
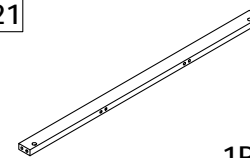
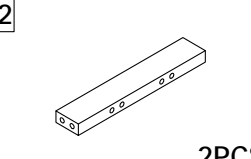
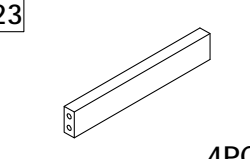
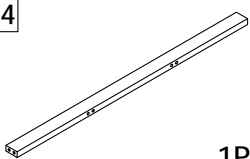
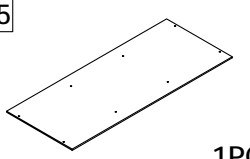
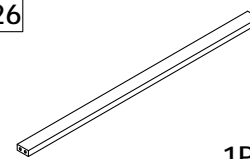
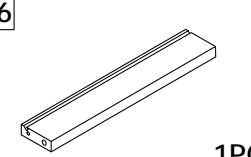
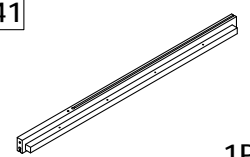
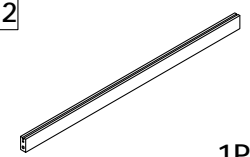
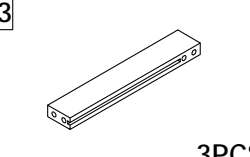
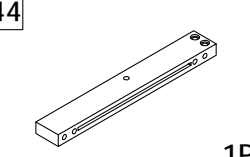
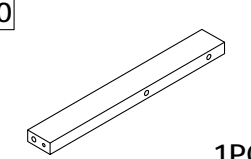
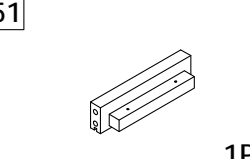
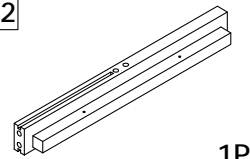
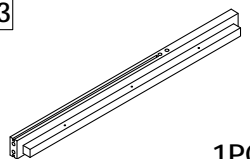
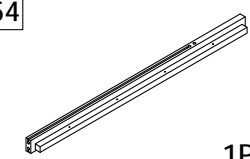
12  1PC	13  1PC	14  2PCS	15  2PCS	16  1PC
17  1PC	18  1PC	19  1PC	20  2PCS	21  1PC
22  2PCS	23  4PCS	24  1PC	25  1PC	26  1PC
36  1PC	41  1PC	42  1PC	43  3PCS	44  1PC
50  1PC	51  1PC	52  1PC	53  1PC	54  1PC

Etagenbett

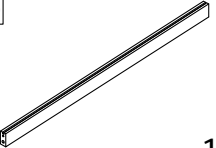
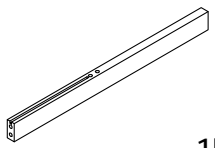
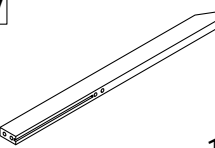
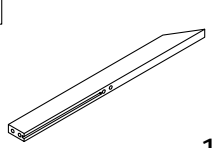
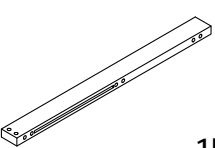
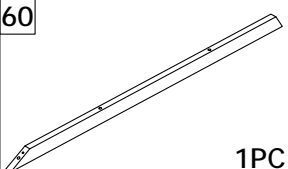
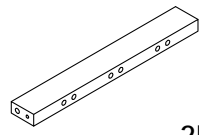
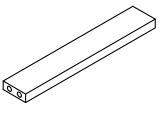
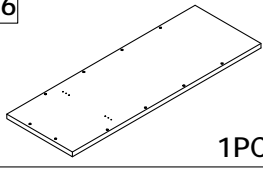
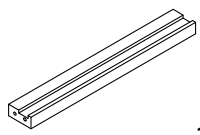
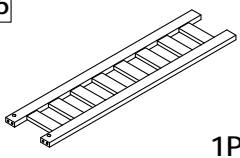
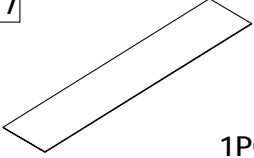
55  1PC	56  1PC	57  1PC	58  1PC	59  1PC
60  1PC	61  2PCS	62  3PCS	66  1PC	67  1PC
76  1PC	77  1PC			

Part List : WF318721

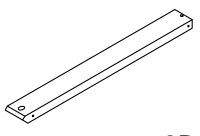
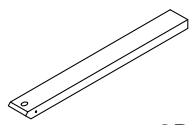
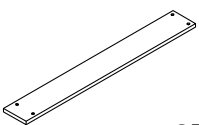
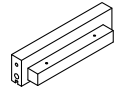
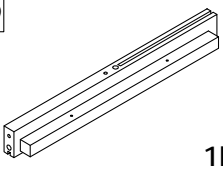
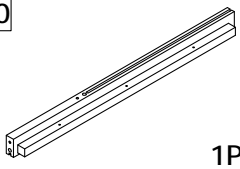
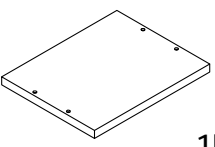
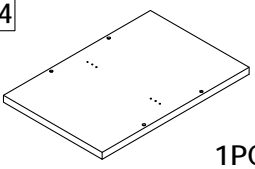
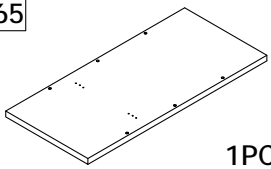
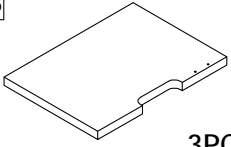
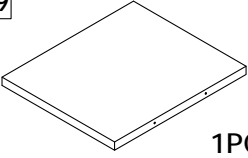
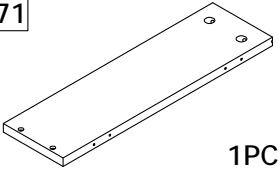
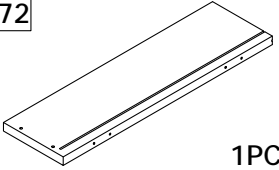
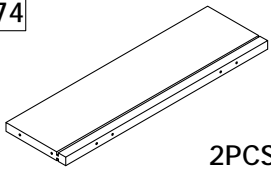
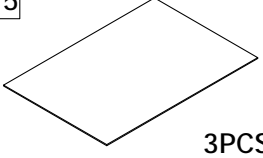
27  2PCS	28  2PCS	32  9PCS	38  1PC	39  1PC
40  1PC	63  1PC	64  1PC	65  1PC	68  3PCS
69  1PC	71  1PC	72  1PC	74  2PCS	75  3PCS

Part List : WF318722

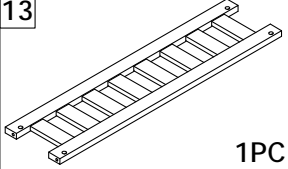
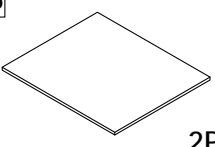
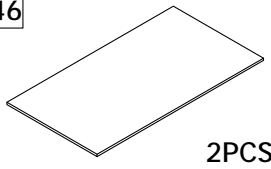
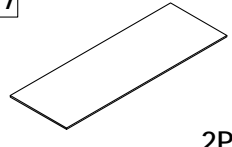
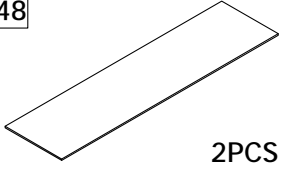
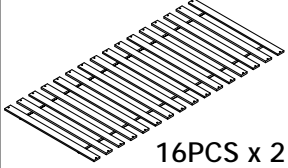
13  1PC	45  2PCS	46  2PCS	47  2PCS	48  2PCS
 16PCS x 2				



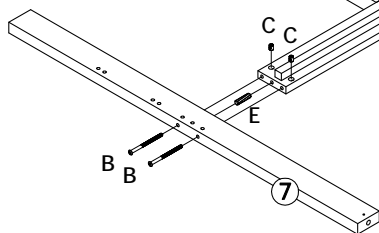
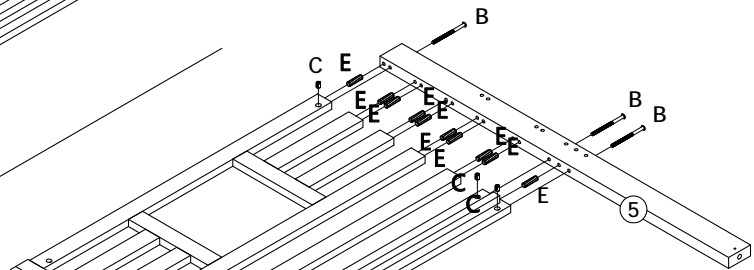
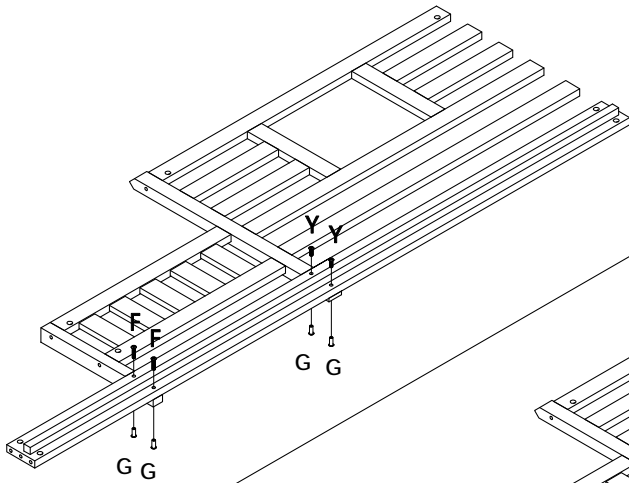
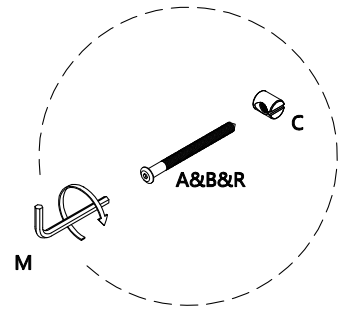
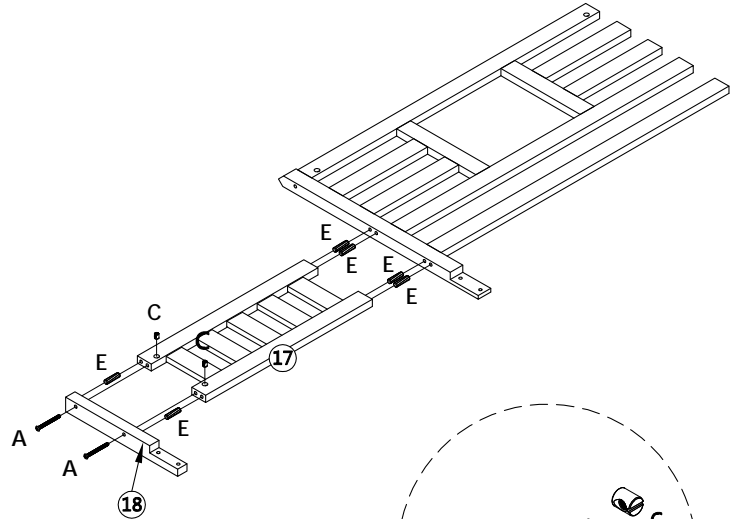
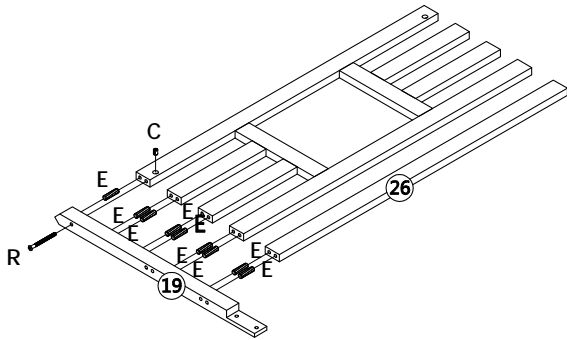
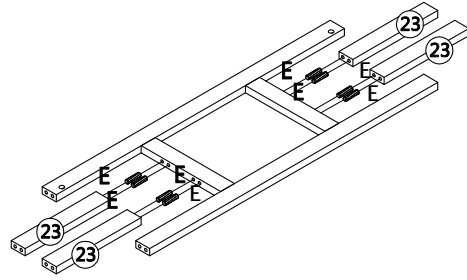
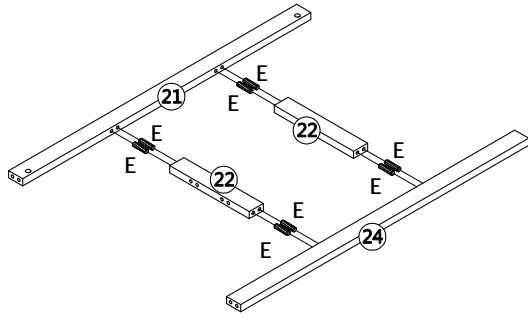

STEP:1

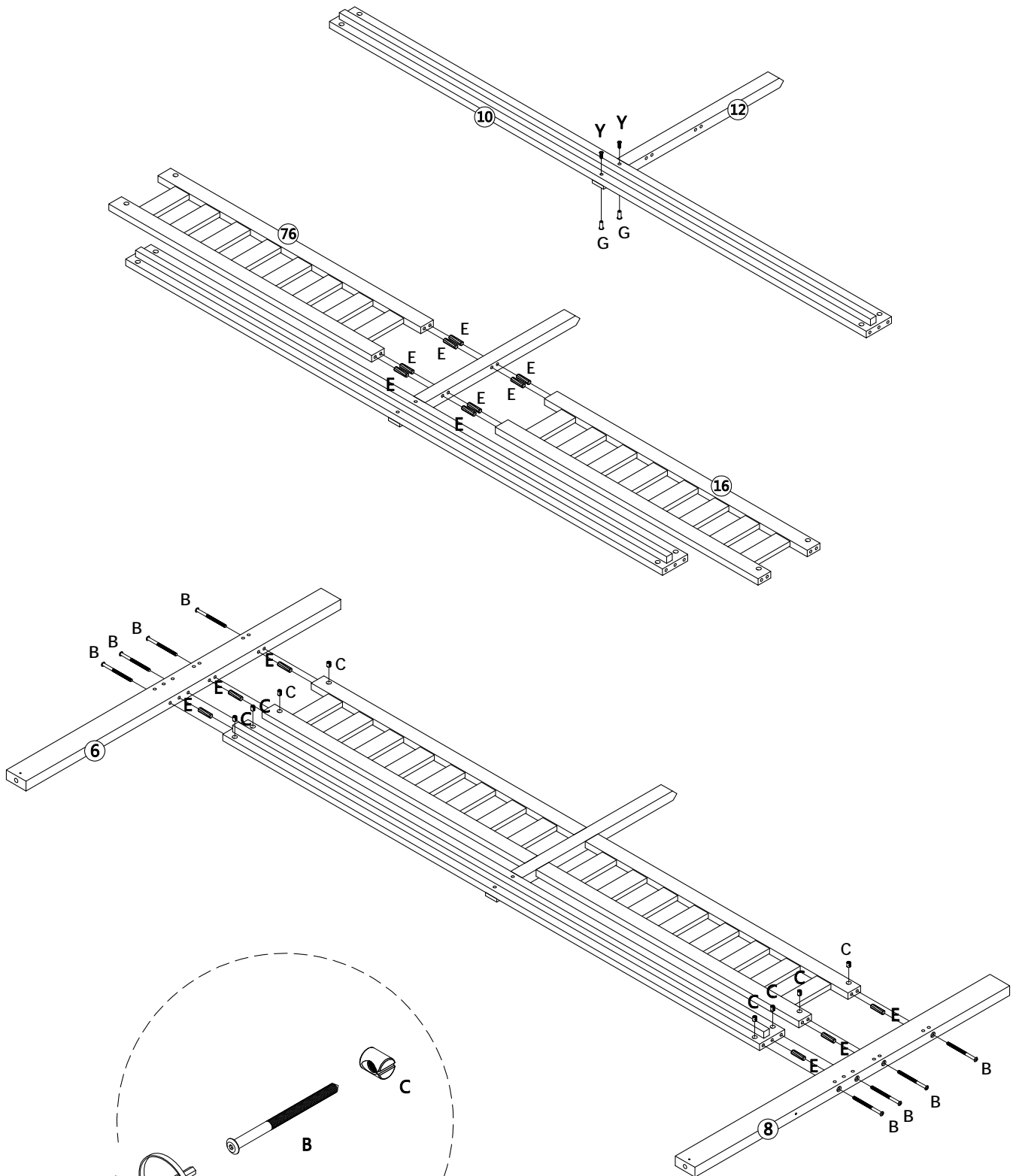

A		M6 x 70	2
B		M6 x 110	5
C		Φ10 x 12	8
E		Φ8 x 30	42
F		M6 x 30	2
G		M6 x 20	4
R		M6 x 80	1
Y		M6 x 25	2





STEP:2

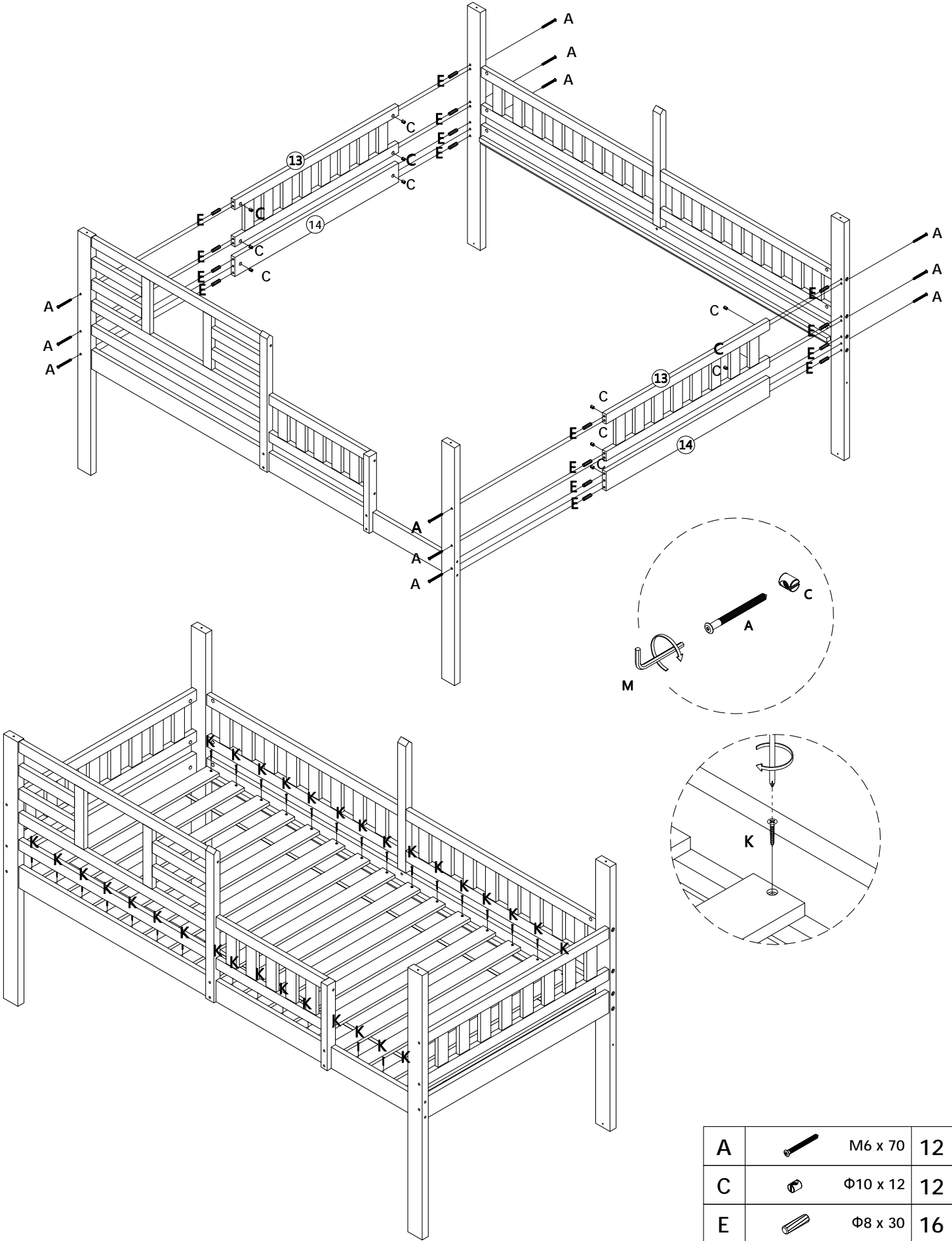

B		M6 x 110	8
C		Φ10 x 12	8
E		Φ8 x 30	14
G		M6 x 20	2
Y		M6 x 25	2

STEP:3



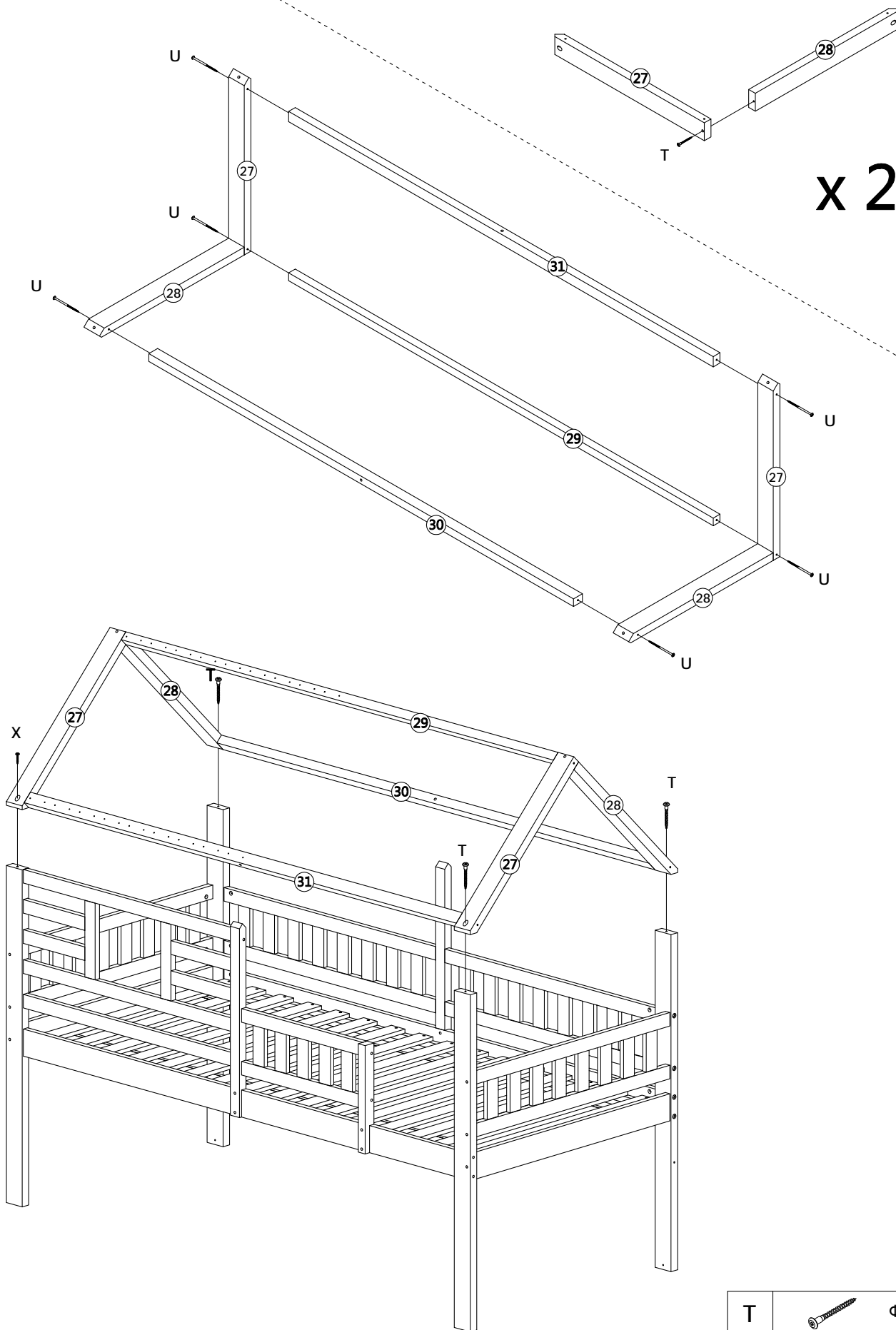

A		M6 x 70	12
C		Φ10 x 12	12
E		Φ8 x 30	16
K		Φ4 x 30	32

STEP:4





x 2

T		Φ6 x 60	5
U		Φ6 x 110	6
X		M6 x 40	1

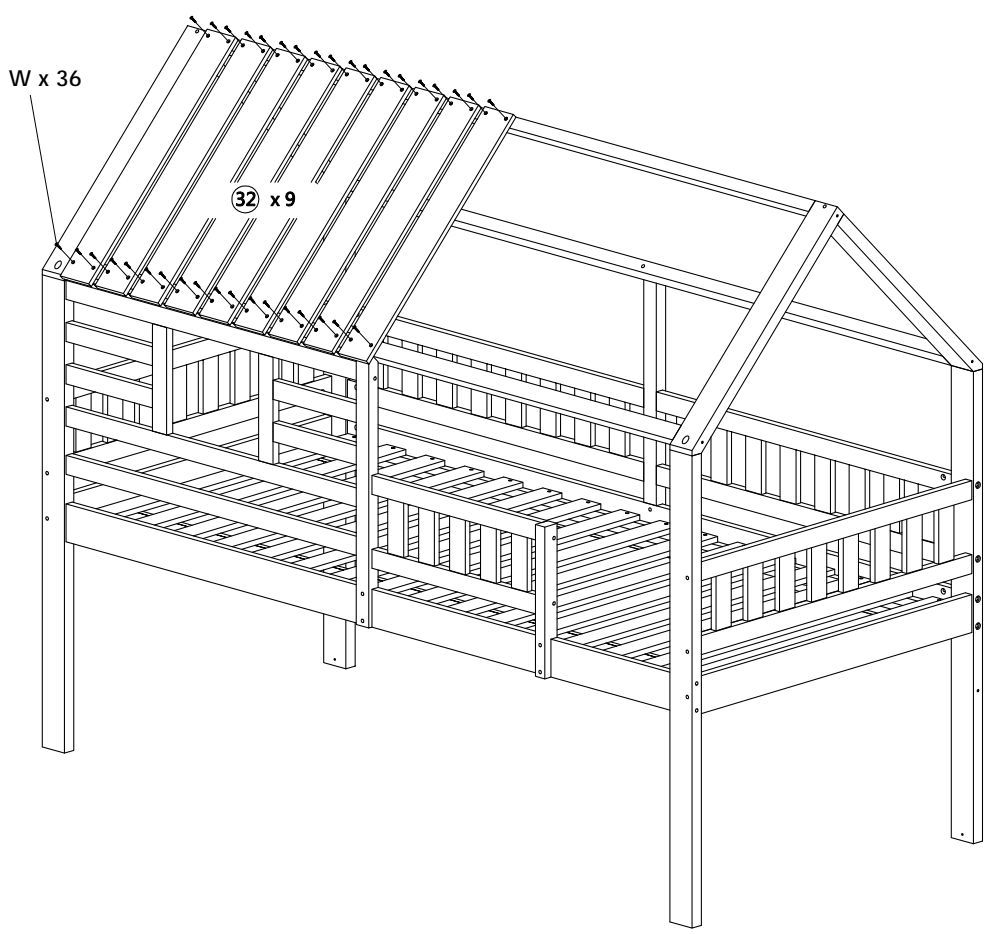
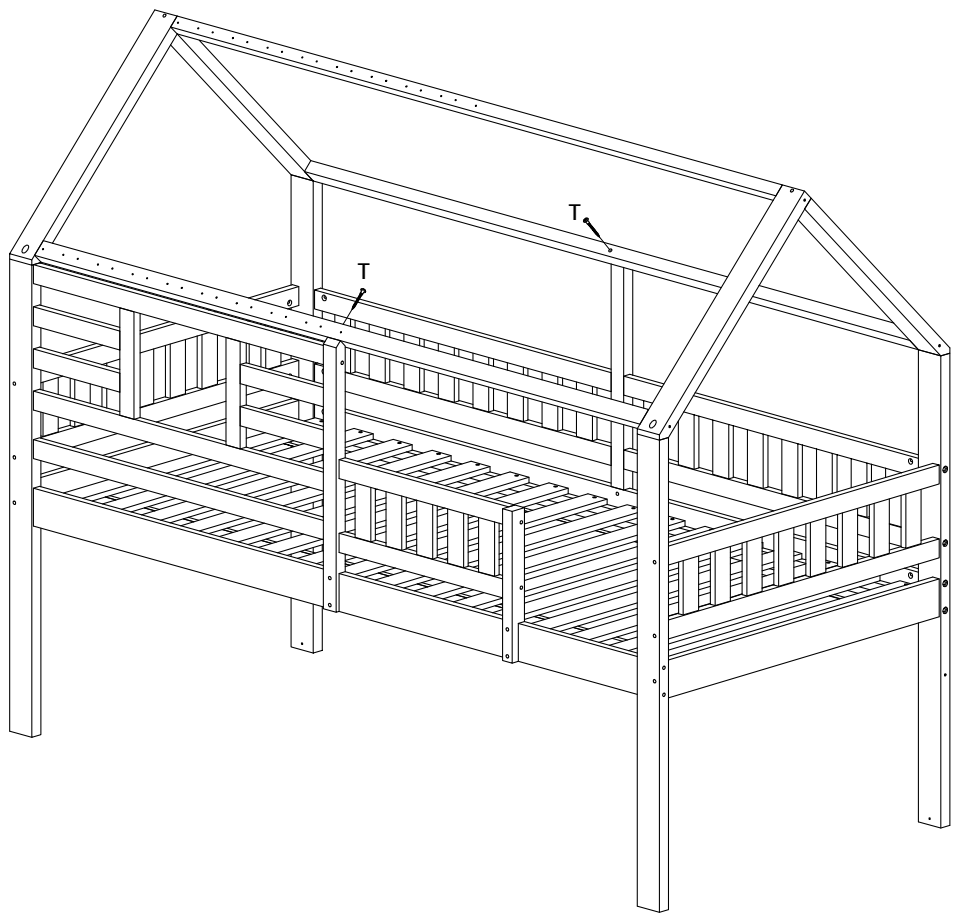
STEP:5







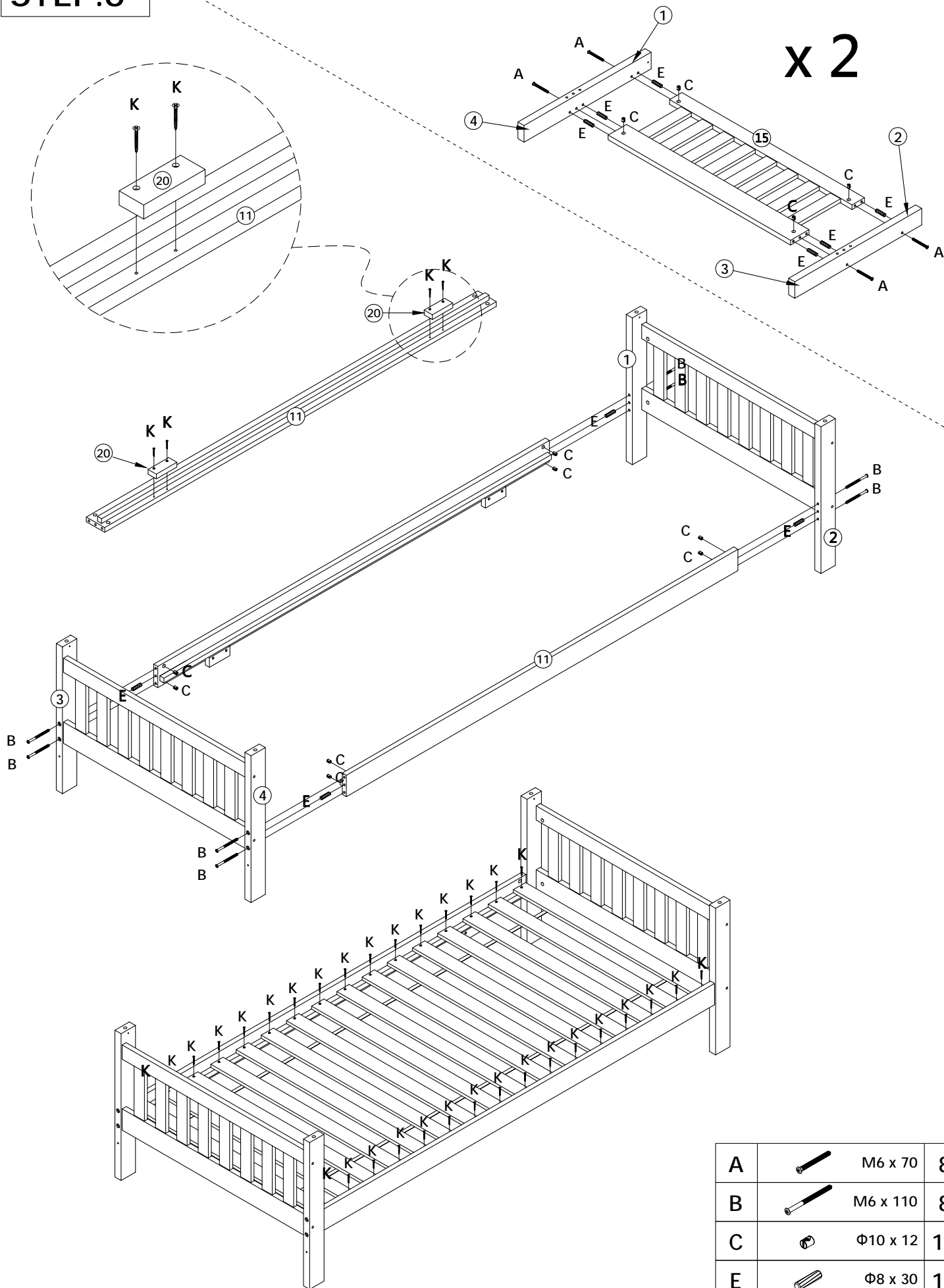

T		Φ6 x 60	2
W		Φ4 x 20	36

STEP:6

One set of panels 1.2.15 and one set of panels 3.4.15



x 2



A		M6 x 70	8
B		M6 x 110	8
C		Φ10 x 12	16
E		Φ8 x 30	16
K		Φ4 x 30	36

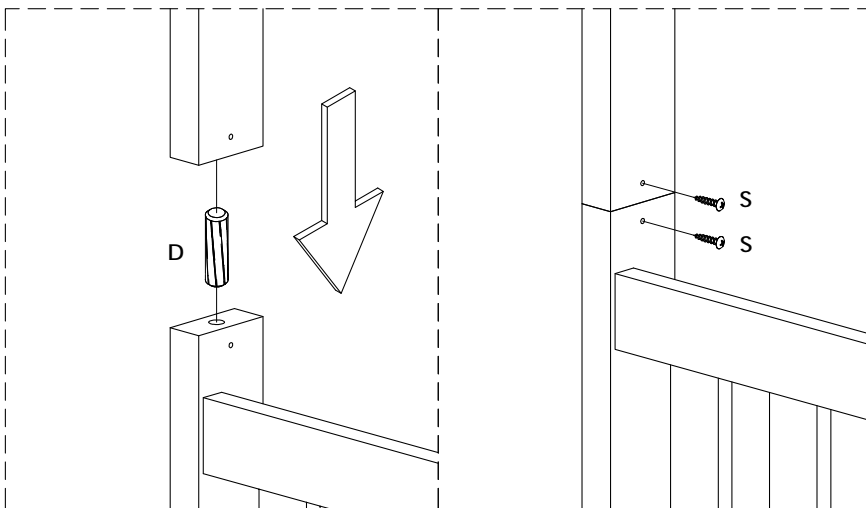
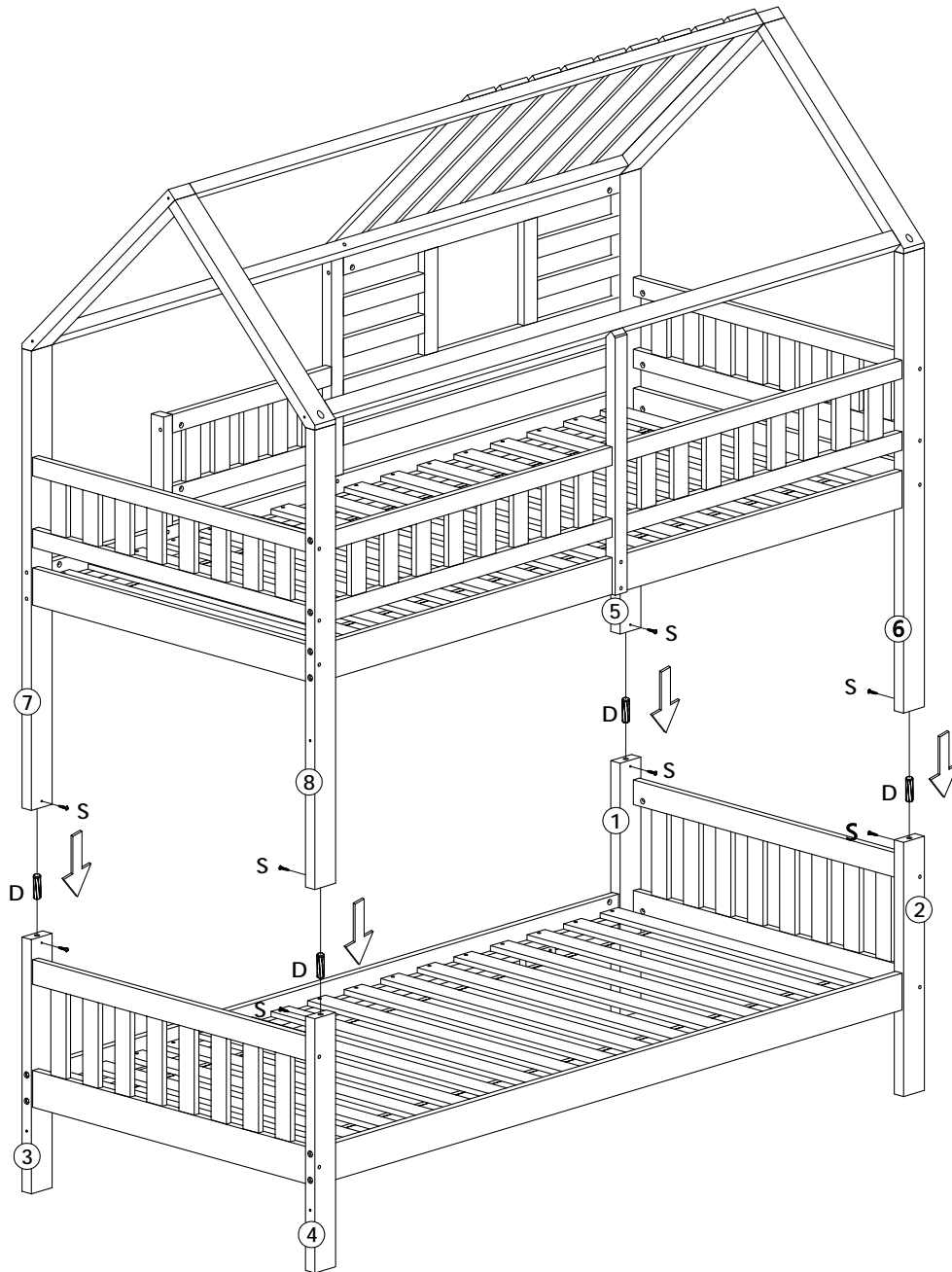



STEP:7

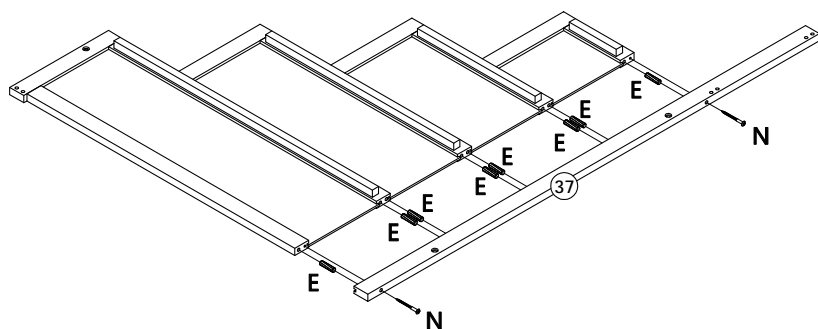
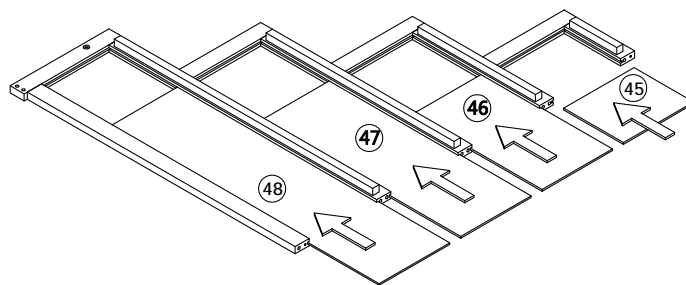
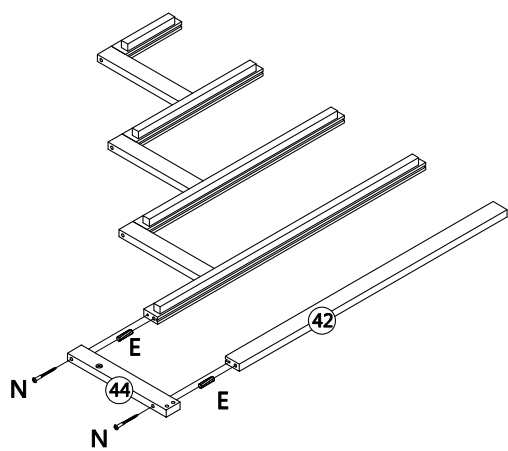
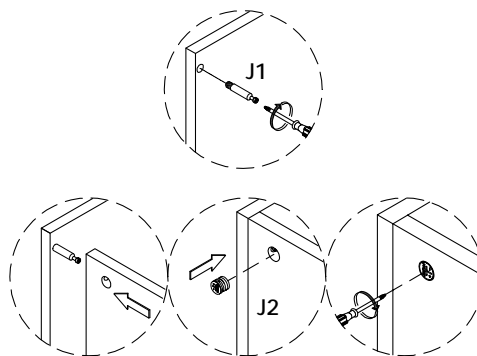
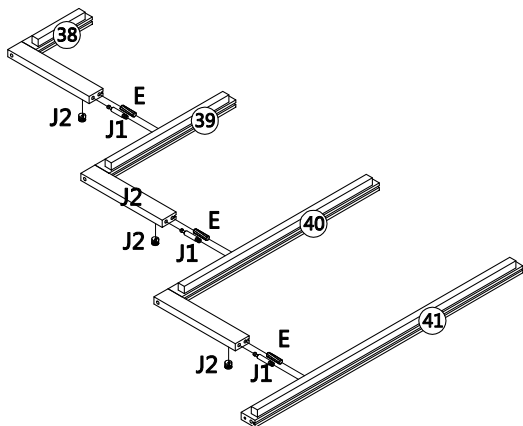
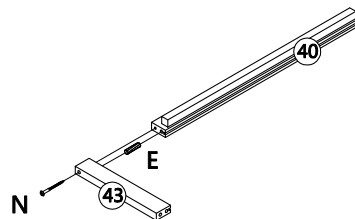
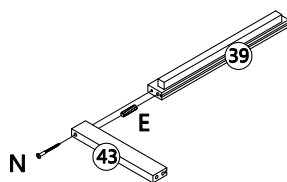
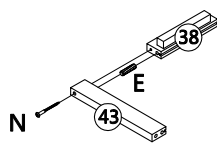

D		Φ12 x 60	4
S		Φ4 x 25	8



STEP:8

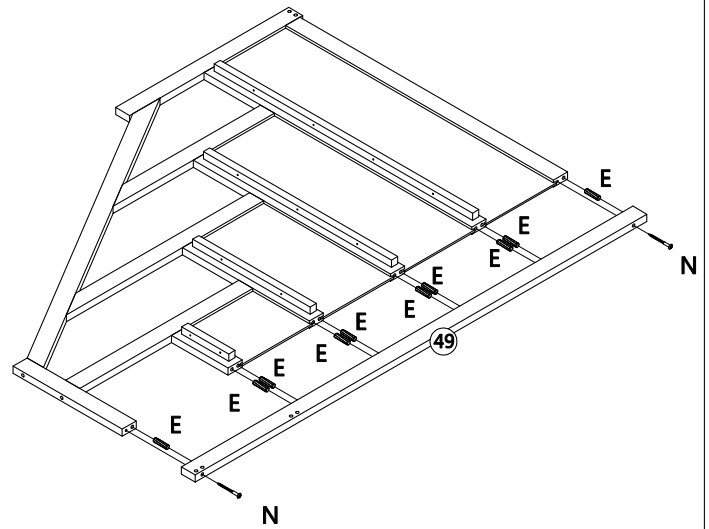
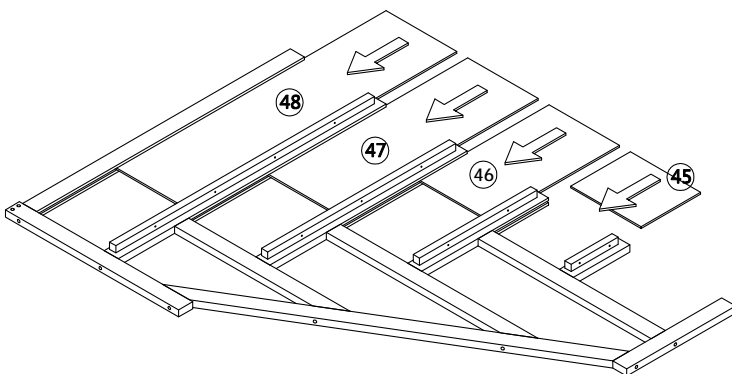
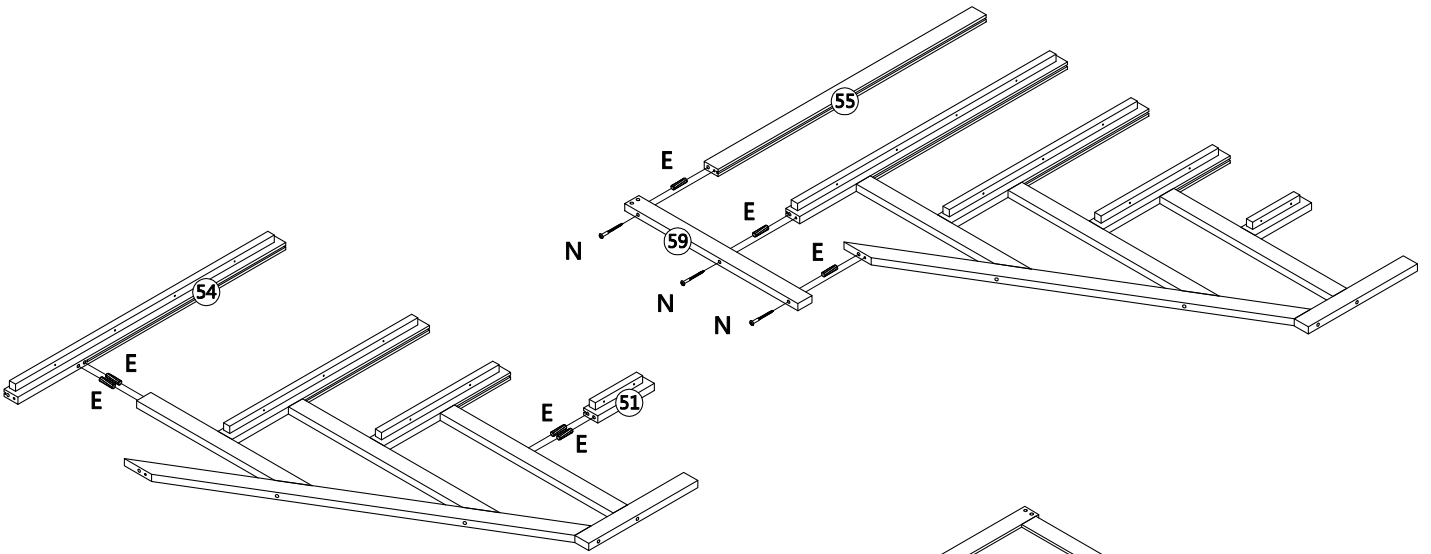
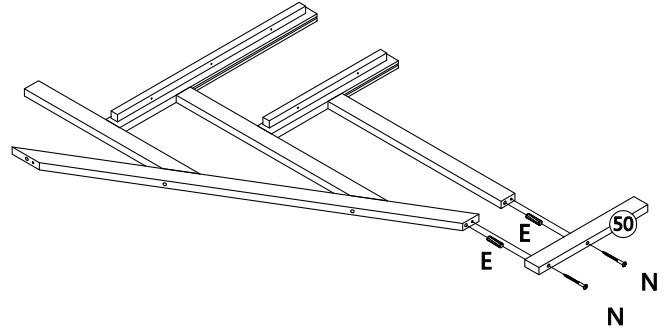
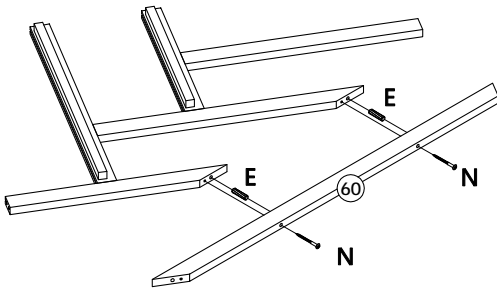
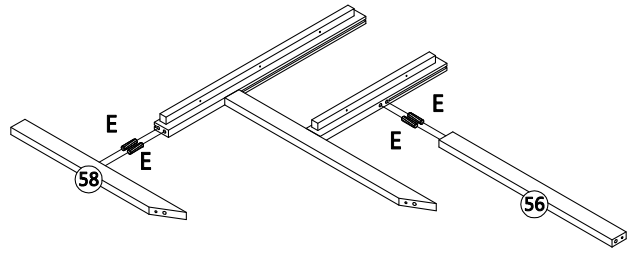
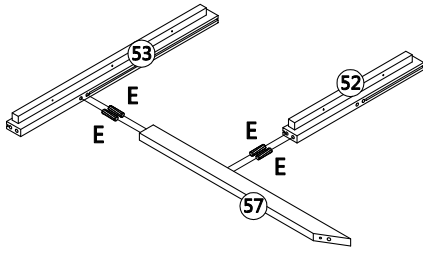

E		Φ8 x 30	16
J			3
N		Φ6 x 70	7

STEP:9



E		Φ8 x 30	29
N		Φ6 x 70	9

STEP:10

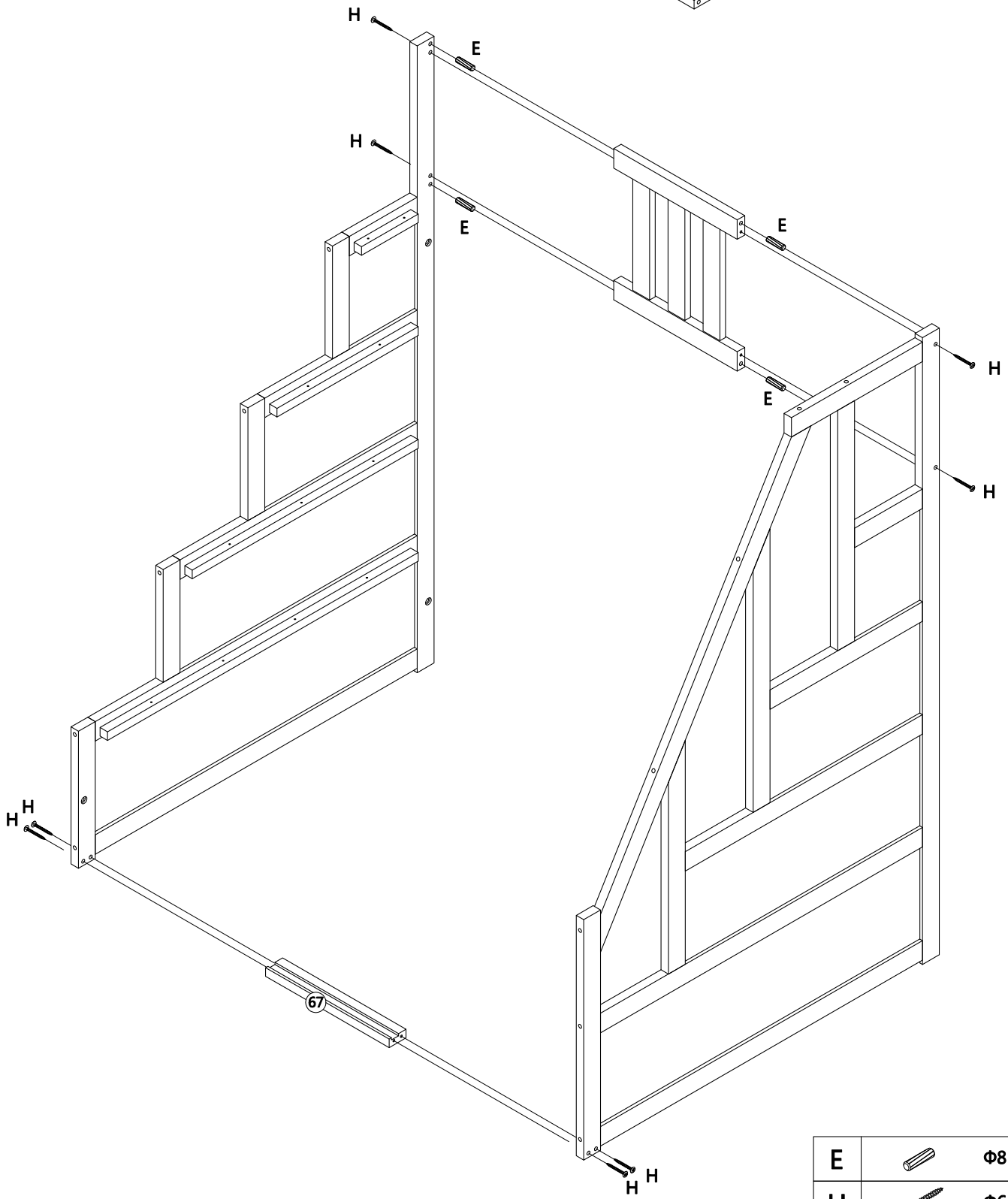
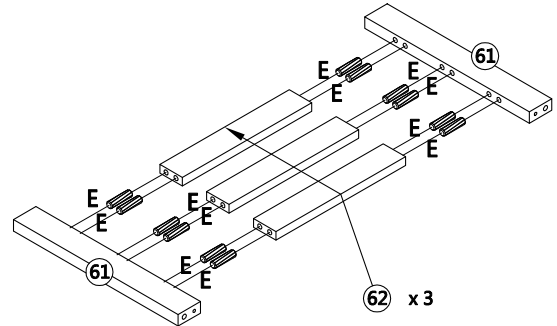

E		Φ8 x 30	4
H		Φ6 x 50	8

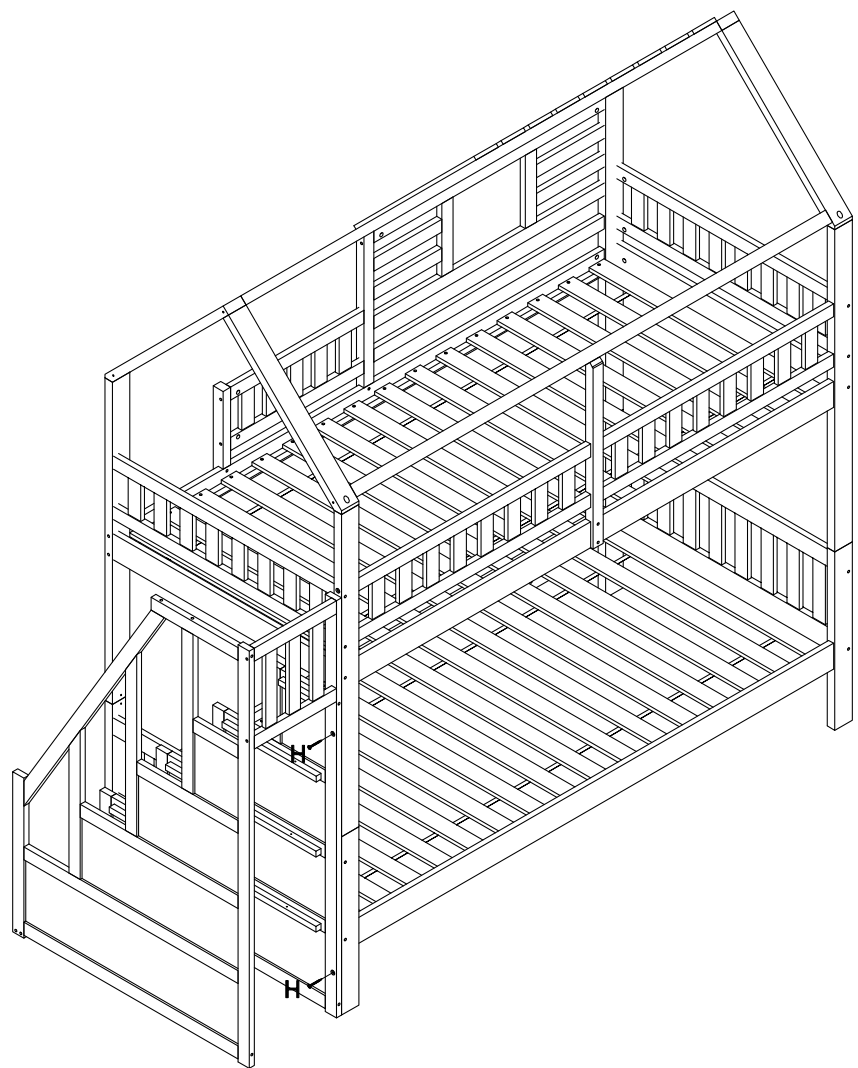
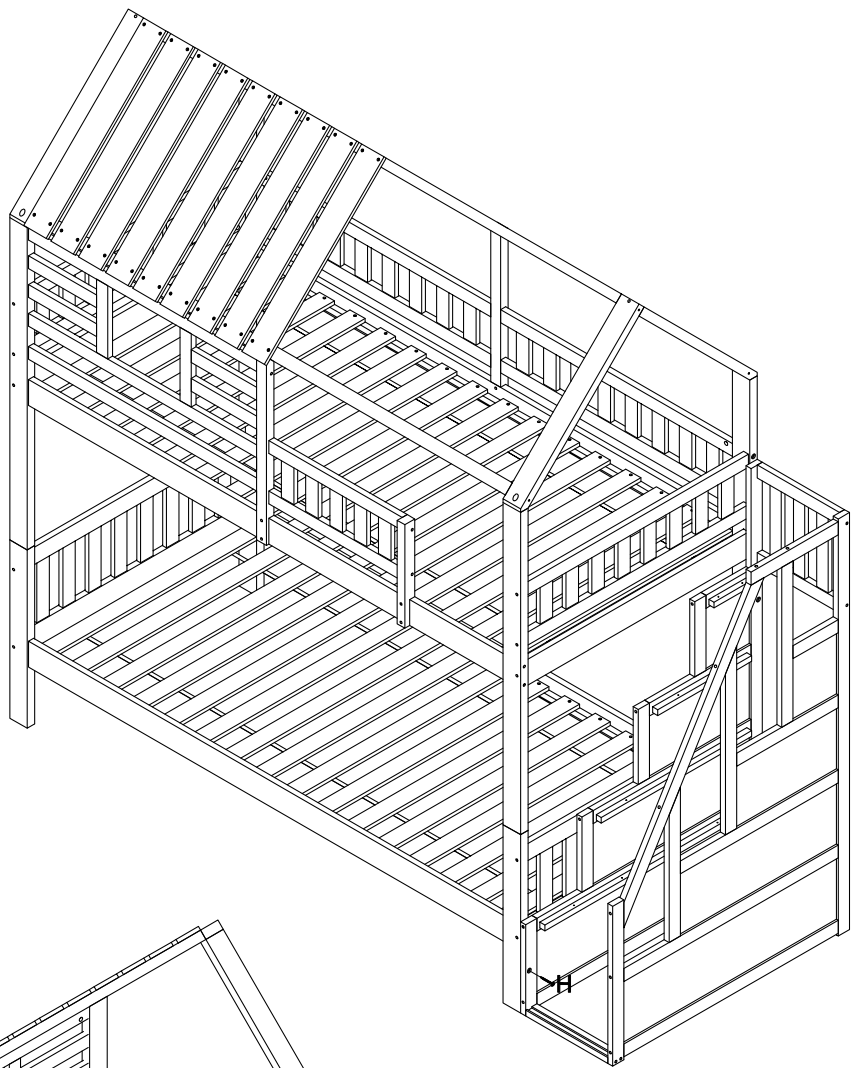

STEP:11

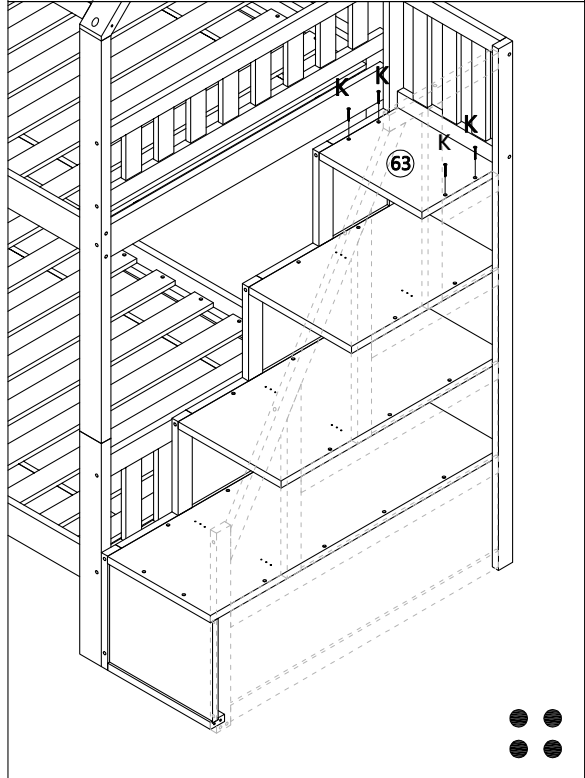
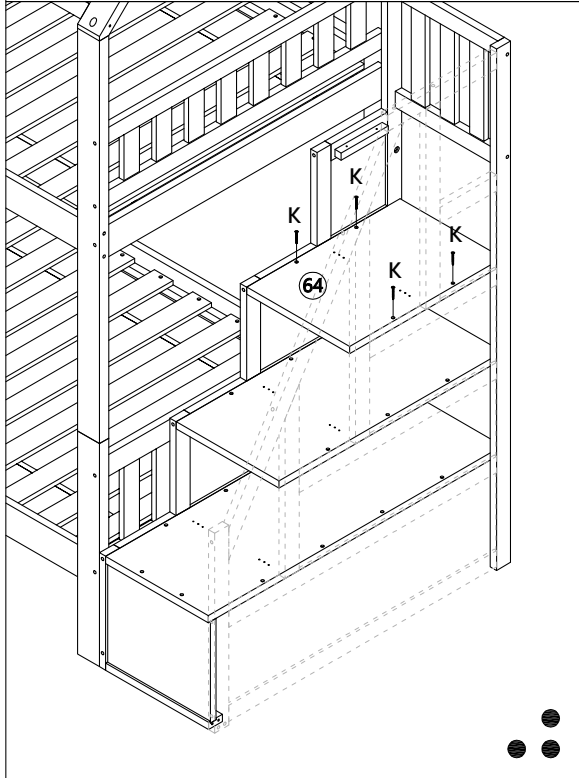
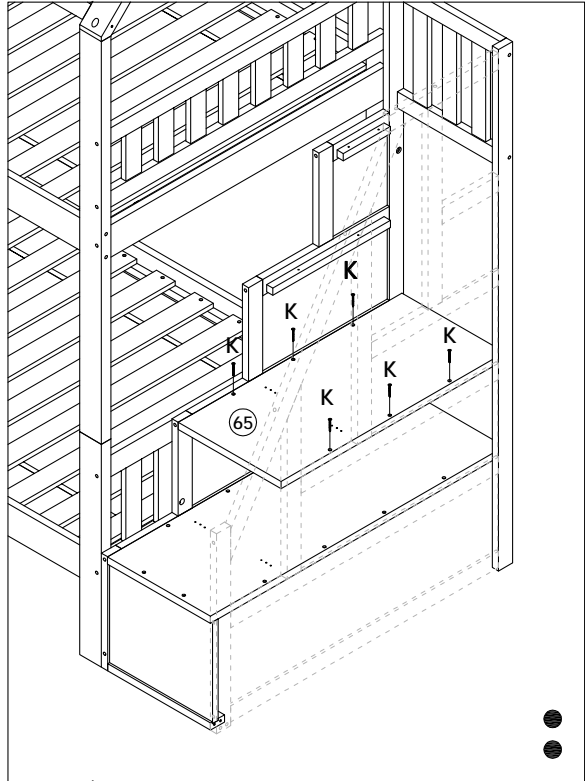
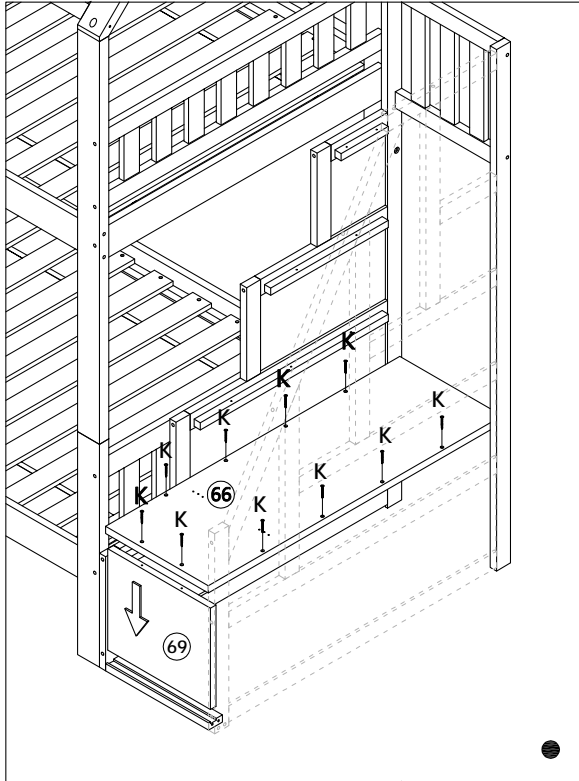
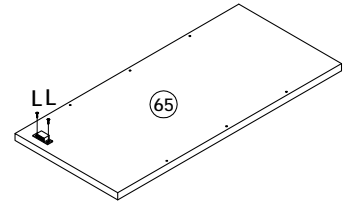
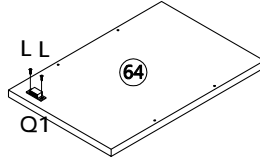
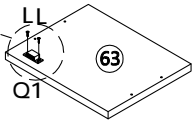
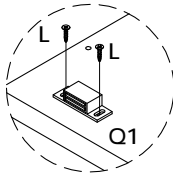

H		Φ6 x 50	3
---	---	---------	---

STEP:12



K		Φ4 x 30	24	L		Φ3.5 x 15	6	Q1		3
---	---	---------	----	---	---	-----------	---	----	---	---

STEP:13

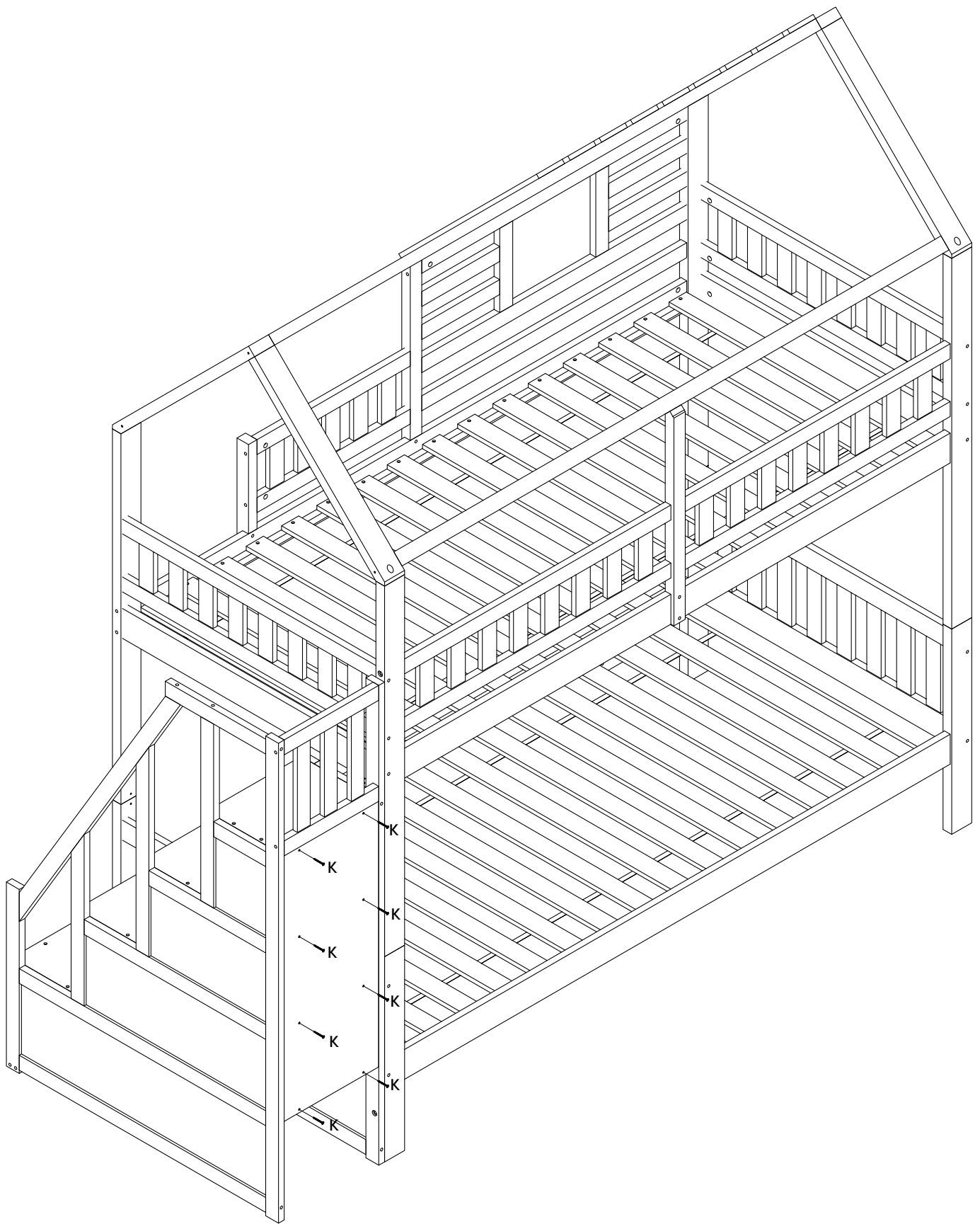



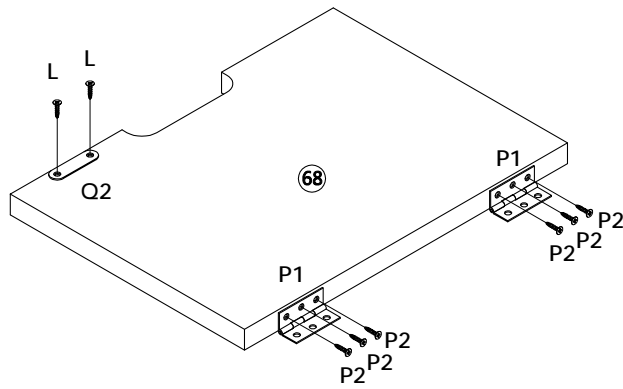

STEP:14

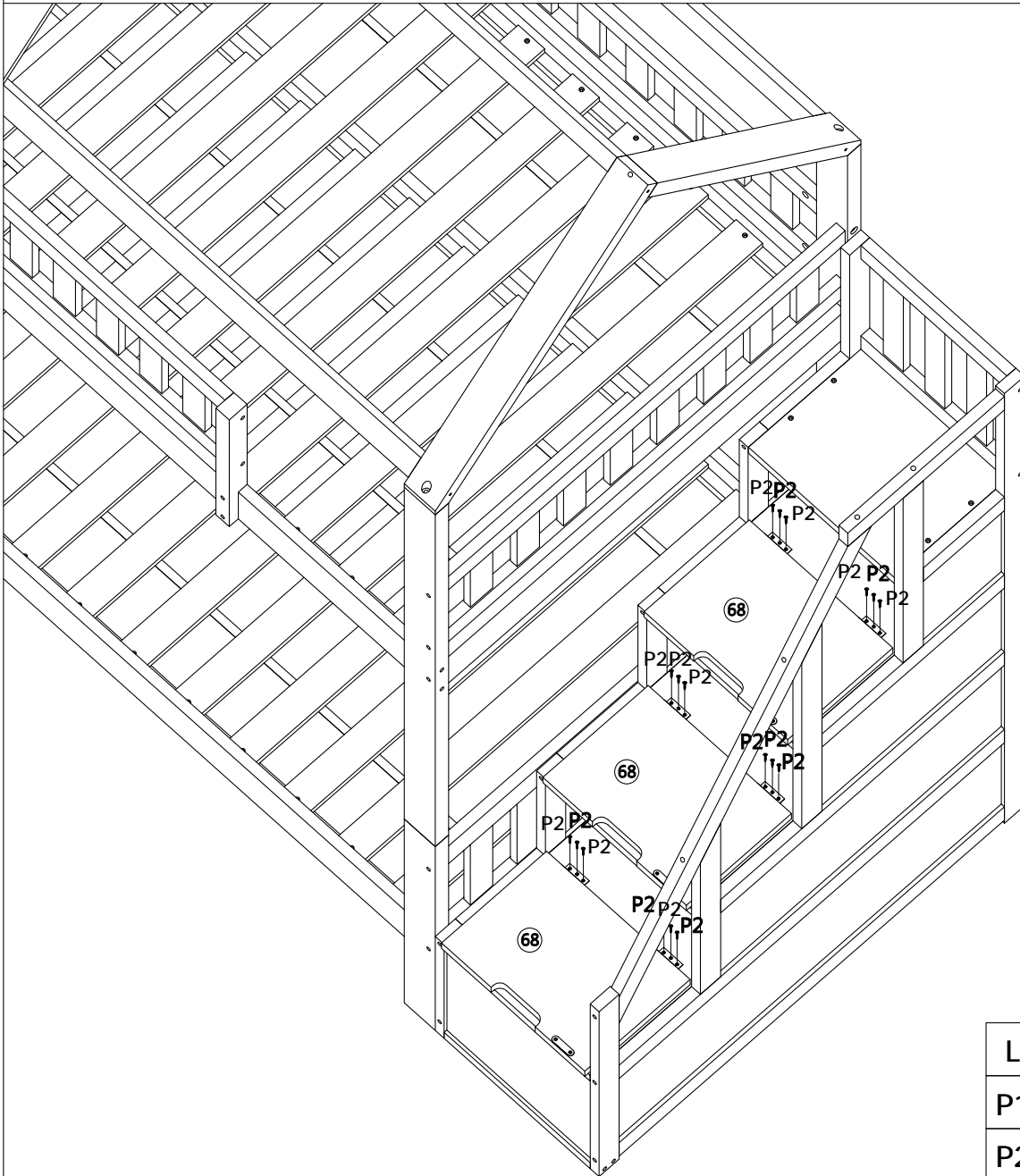







x 3

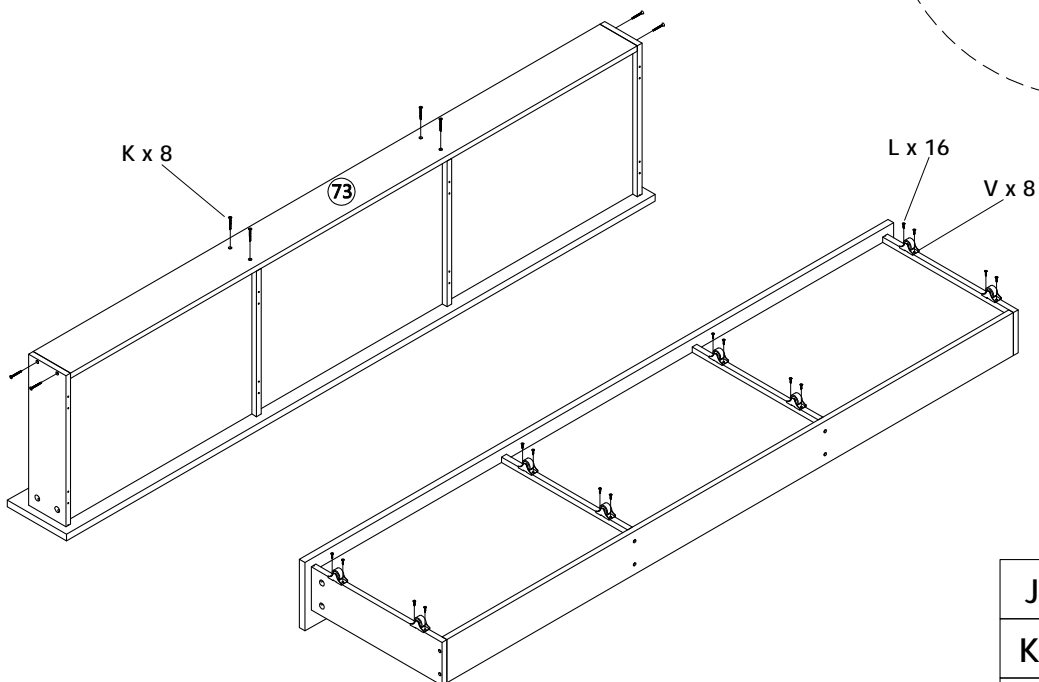
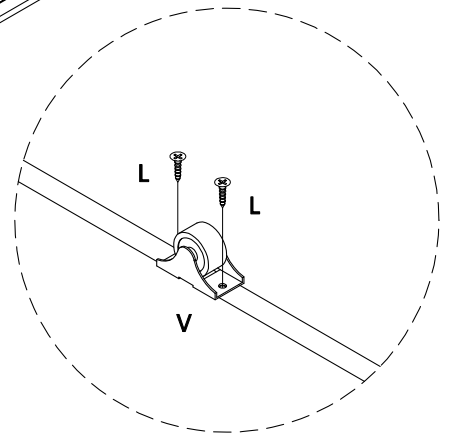
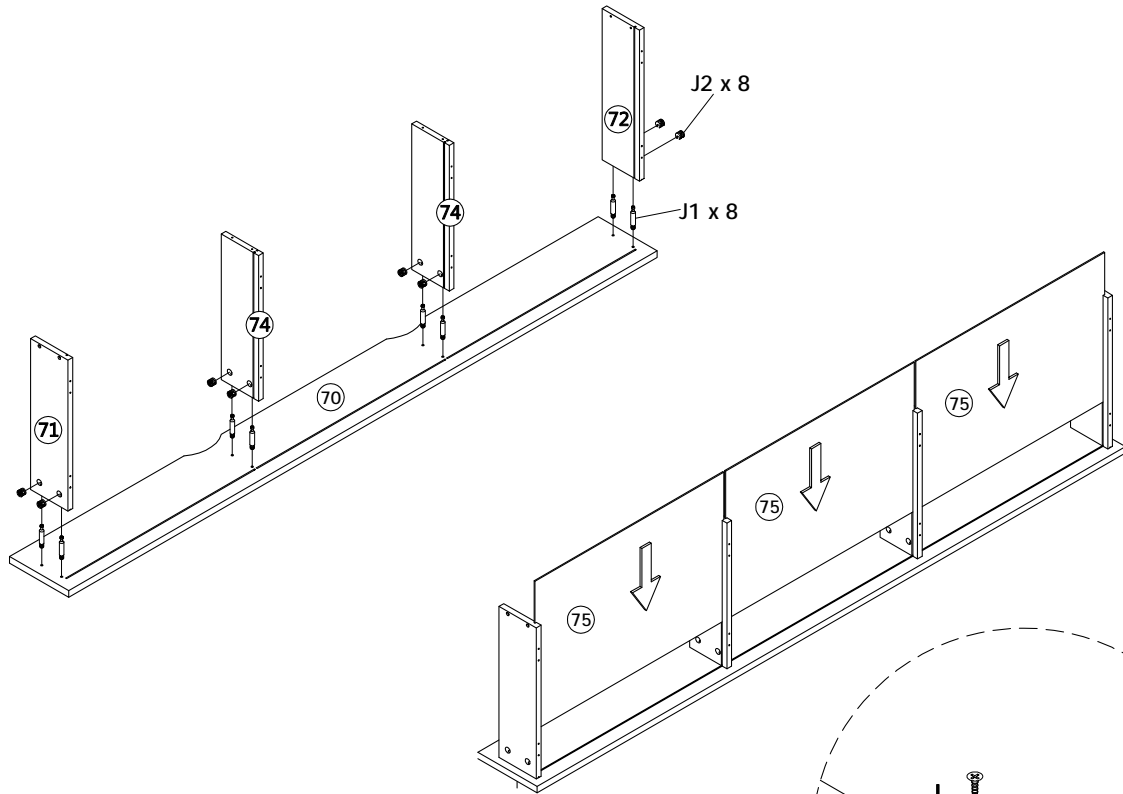
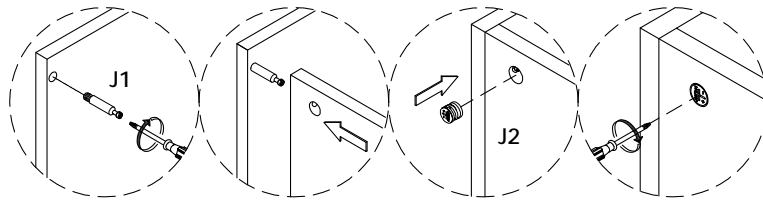

L		Φ3.5 x 15	6
P1			6
P2		Φ3 x 16	36
Q2			3

STEP:15





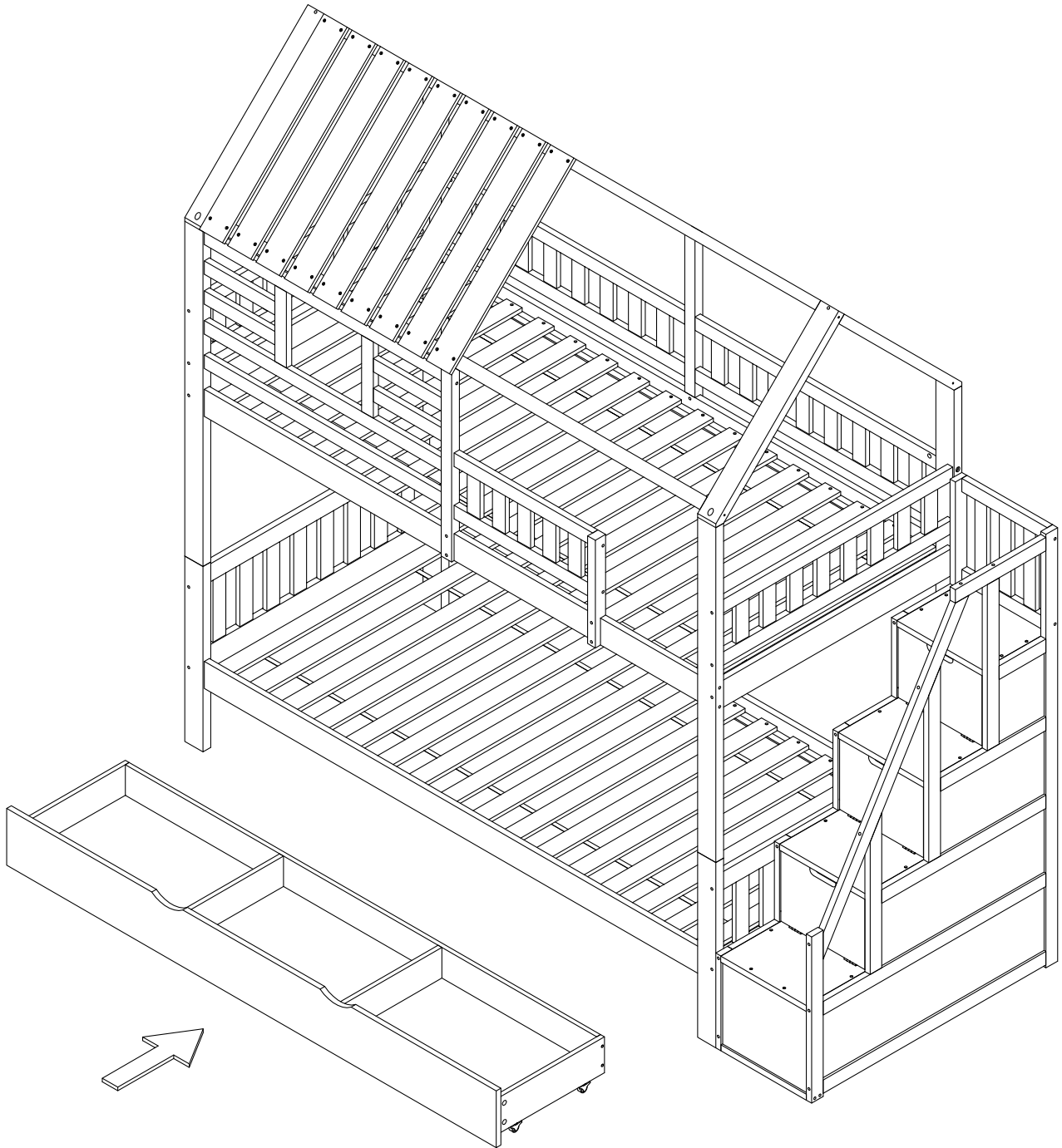

J			8
K		Φ4 x 30	8
L		Φ3.5 x 15	16
V			8

STEP:16

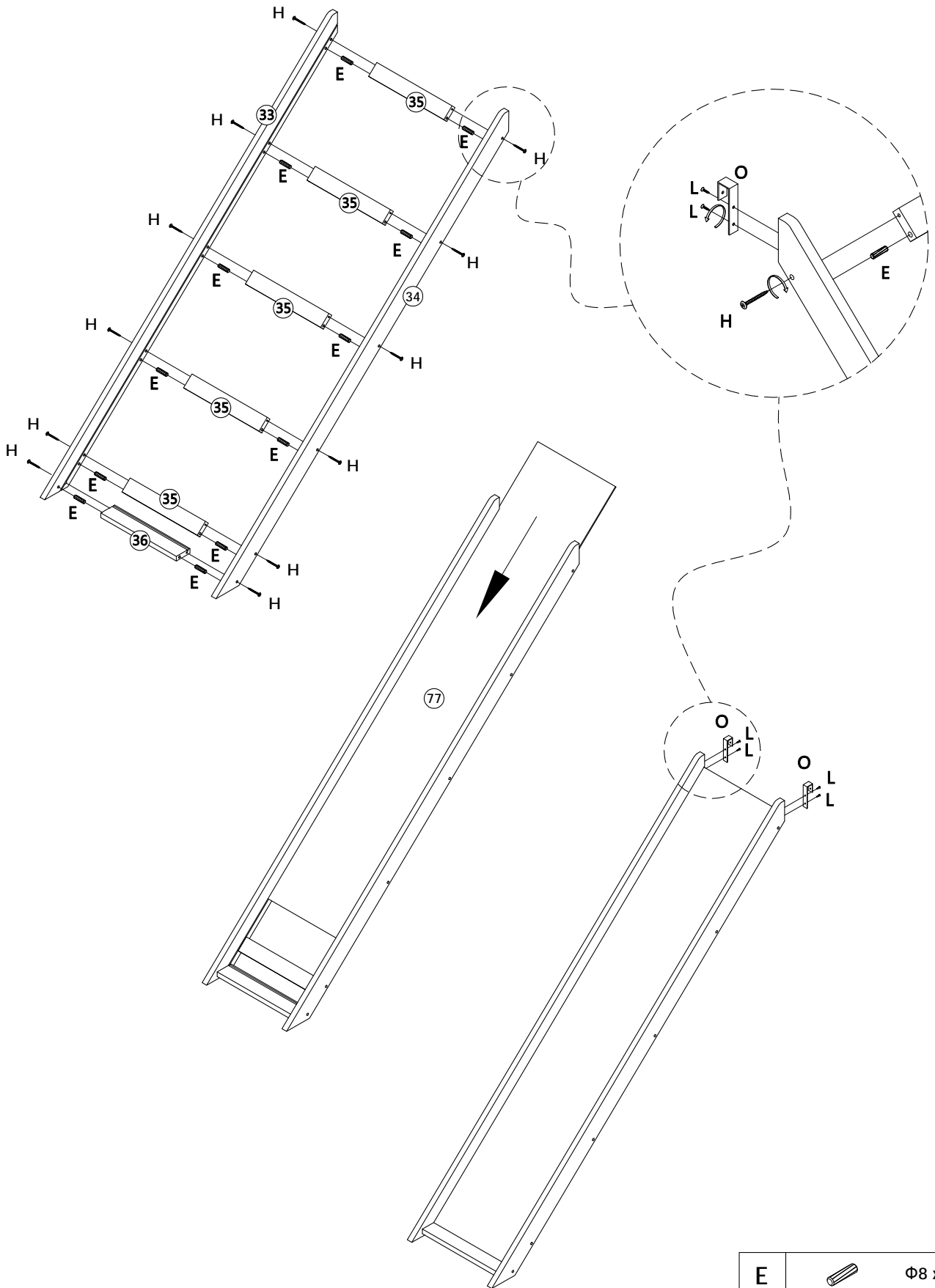



STEP:17

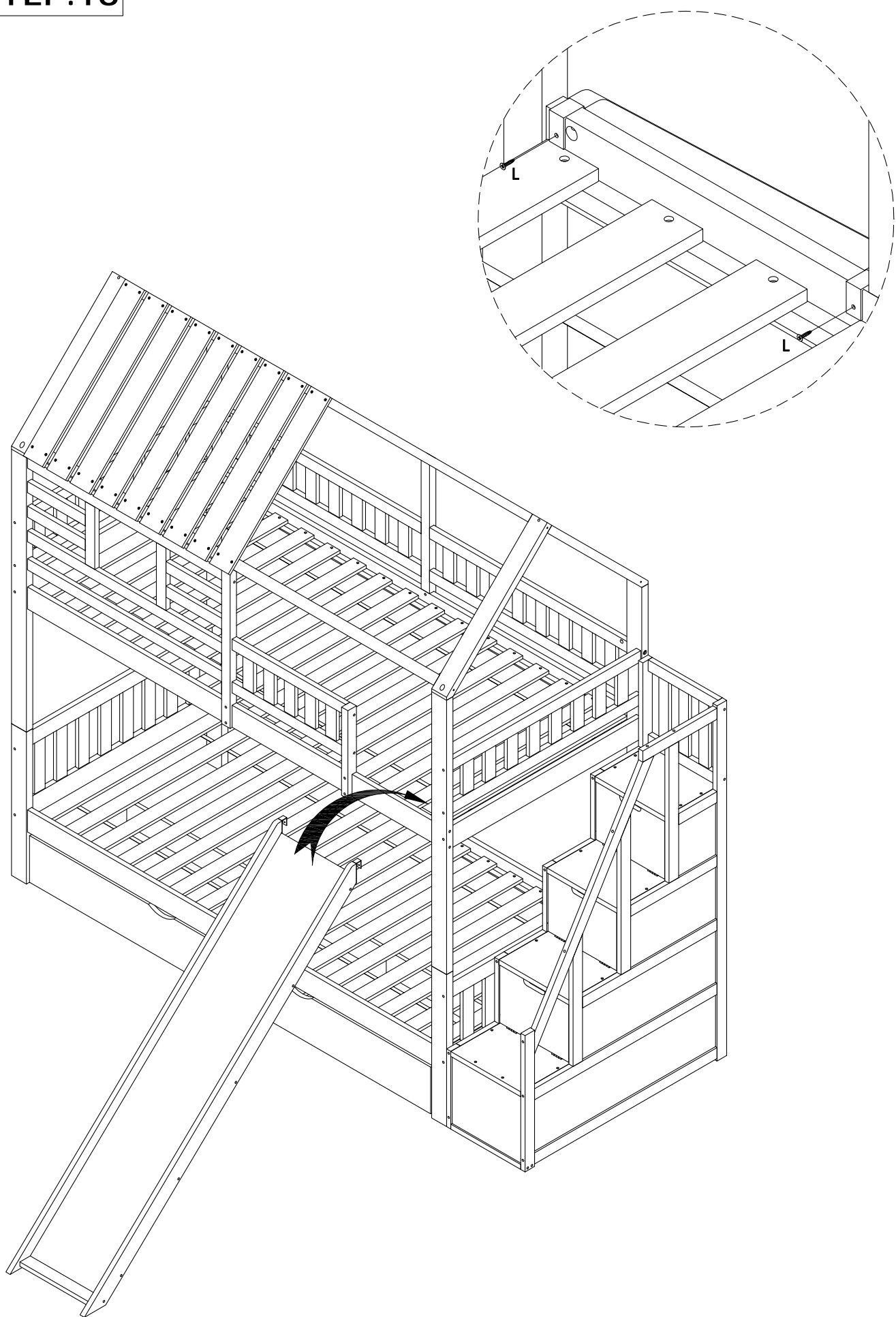

E		Φ8 x 30	12
H		Φ6 x 50	12
L		Φ3.5 x 15	4
O			2

STEP:18



L		Φ3.5 x 15	2
---	---	-----------	---