

BOX-1 WF322801

BOX-2 WF322802

Gebrauchsanweisung

Manuel du produit

Manual del producto

Manuale del prodotto

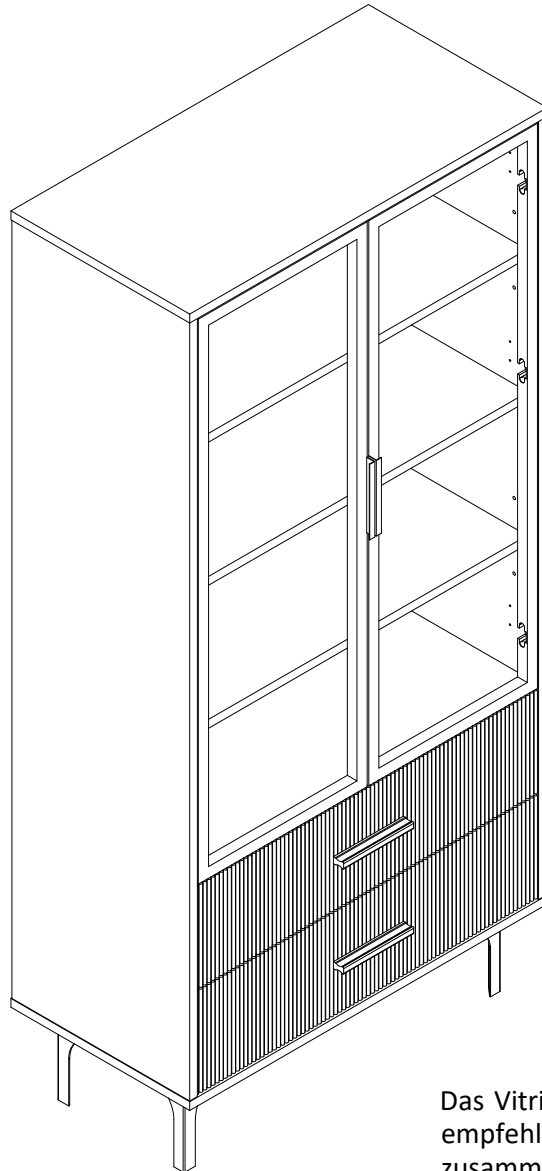





Das Vitrinewird mit 2 Kartons geliefert. Wir empfehlen, das Set nach Erhalt aller Kartons zusammenzustellen.

The display case comes with 2 boxes. We recommend putting the set together after receiving all the boxes.

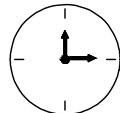
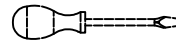
La vitrine est livrée avec 2 boîtes. Nous vous recommandons de monter l'ensemble après avoir reçu toutes les boîtes.

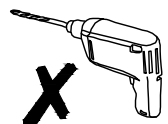
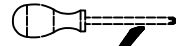

 2PERS	 55 MIN	Tool Required Not Provided	
		 	
		 	

Sicherheits- und Pflegehinweise

Wichtig: Bitte lesen Sie diese Anweisungen vollständig durch, bevor Sie mit der Montage beginnen.

Achtung: Dieses Gerät ist relativ schwer. Bitte heben Sie es vorsichtig an. Überprüfen Sie, ob alle auf den Seiten aufgeführten Komponenten und Werkzeuge vorhanden sind.

Entfernen Sie sämtliches Zubehör aus den Plastiktüten und teilen Sie es in seine Gruppen auf.

Halten Sie Kinder und Tiere vom Arbeitsbereich fern, Kleinteile könnten beim Verschlucken ersticken. Teile der Montage sind mit 2 Personen einfacher.

Stellen Sie sicher, dass Sie genügend Platz haben, um die Teile anzuordnen, bevor Sie beginnen.

Stellen Sie sich nicht auf das Produkt und belasten Sie es nicht, dies könnte zu Schäden führen.

Montieren Sie den Gegenstand so nah wie möglich an seiner endgültigen Position im selben Raum.

Montieren Sie das Gerät auf einer weichen, ebenen Oberfläche, um eine Beschädigung des Geräts oder Ihres Bodens zu vermeiden. Verwenden Sie dazu den geöffneten Gerätekarton.

Pflege und Wartung

Reinigen Sie das Gerät nur mit einem feuchten Tuch und einem milden Reinigungsmittel.

Verwenden Sie keine Bleichmittel oder Scheuermittel. Überprüfen Sie von Zeit zu Zeit, ob sich an diesem Gerät keine Schrauben gelöst haben.

(Notiz)

Bei Bedarf kann die nächste Seite ausgeschnitten und während der gesamten Zusammenstellung als Referenz verwendet werden.

Bewahren Sie diese Seite zusammen mit diesen Anweisungen zum späteren Nachschlagen im Produkthandbuch auf.

Dieses Produkt besteht aus 2 Logistikpaketen. Bitte überprüfen Sie die Anzahl Ihrer Pakete. Wenn eines fehlt, wenden Sie sich bitte an die Logistik.

Bitte lesen Sie alle Vorsichtsmaßnahmen und Anweisungen in diesem Handbuch, bevor Sie dieses Produkt verwenden.

Wenn Sie Fragen zu diesem Produkt haben, wenden Sie sich bitte rechtzeitig an Ihren Lieferanten.

Safety and Care Advice

Important - Please read these instructions fully before starting assembly

Warning: This unit is relatively heavy. Please lift with care. Check you have all the components and tools listed on pages.

Remove all fittings from the plastic bags and separate them into their groups.

Keep children and animals away from the work area, small parts could choke if swallowed. Parts of the assembly will be easier with 2 people.

Make sure you have enough space to layout the parts before starting. Do not stand or put weight on the product, this could cause damage.

Assemble the item as close as possible to its final position in the same room.

Assemble on a soft level surface to avoid damaging the unit or your floor use opened out unit carton.

Care and maintenance

Only clean using a damp cloth and mild detergent, do not use bleach or abrasive cleaners. From time to time check that there are no loose screws on this unit.

(Note)

If required the next page can be cut out and used as reference throughout the assembly.

Keep this page with these instructions for future reference Product Manual.

This product consists of 2 logistics packages, please check the number of your packages, if there is any missing, please contact the logistics.

Please read all precautions and instructions in this manual before using this product.

If you have any questions about this product, please contact your supplier in time.

Conseils de sécurité et d'entretien

Important - Veuillez lire entièrement ces instructions avant de commencer l'assemblage

Attention : cet appareil est relativement lourd. Veuillez soulever avec précaution. Vérifiez que vous disposez de tous les composants et outils répertoriés sur les pages.

Retirez tous les raccords des sacs en plastique et séparez-les en groupes.

Gardez les enfants et les animaux éloignés de la zone de travail, les petites pièces pourraient s'étouffer en cas d'ingestion. Les pièces de l'assemblage seront plus faciles à 2 personnes.

Assurez-vous de disposer de suffisamment d'espace pour disposer les pièces avant de commencer. Ne vous tenez pas debout et ne mettez pas de poids sur le produit, cela pourrait l'endommager.

Assemblez l'objet le plus près possible de sa position finale dans la même pièce.

Assemblez sur une surface douce pour éviter d'endommager l'unité ou votre sol, utilisez le carton de l'unité ouvert.

Entretien et maintenance

Nettoyez uniquement à l'aide d'un chiffon humide et d'un détergent doux, n'utilisez pas d'eau de Javel ni de nettoyeurs abrasifs. Vérifiez de temps en temps qu'il n'y a pas de vis desserrées sur cet appareil.

(Note)

Si nécessaire, la page suivante peut être découpée et utilisée comme référence tout au long de l'assemblage.

Conservez cette page avec ces instructions pour référence future du manuel du produit.

Ce produit se compose de 2 colis logistiques, veuillez vérifier le numéro de vos colis, s'il en manque, veuillez contacter la logistique.

Veuillez lire toutes les précautions et instructions de ce manuel avant d'utiliser ce produit.

Si vous avez des questions sur ce produit, veuillez contacter votre fournisseur à temps.

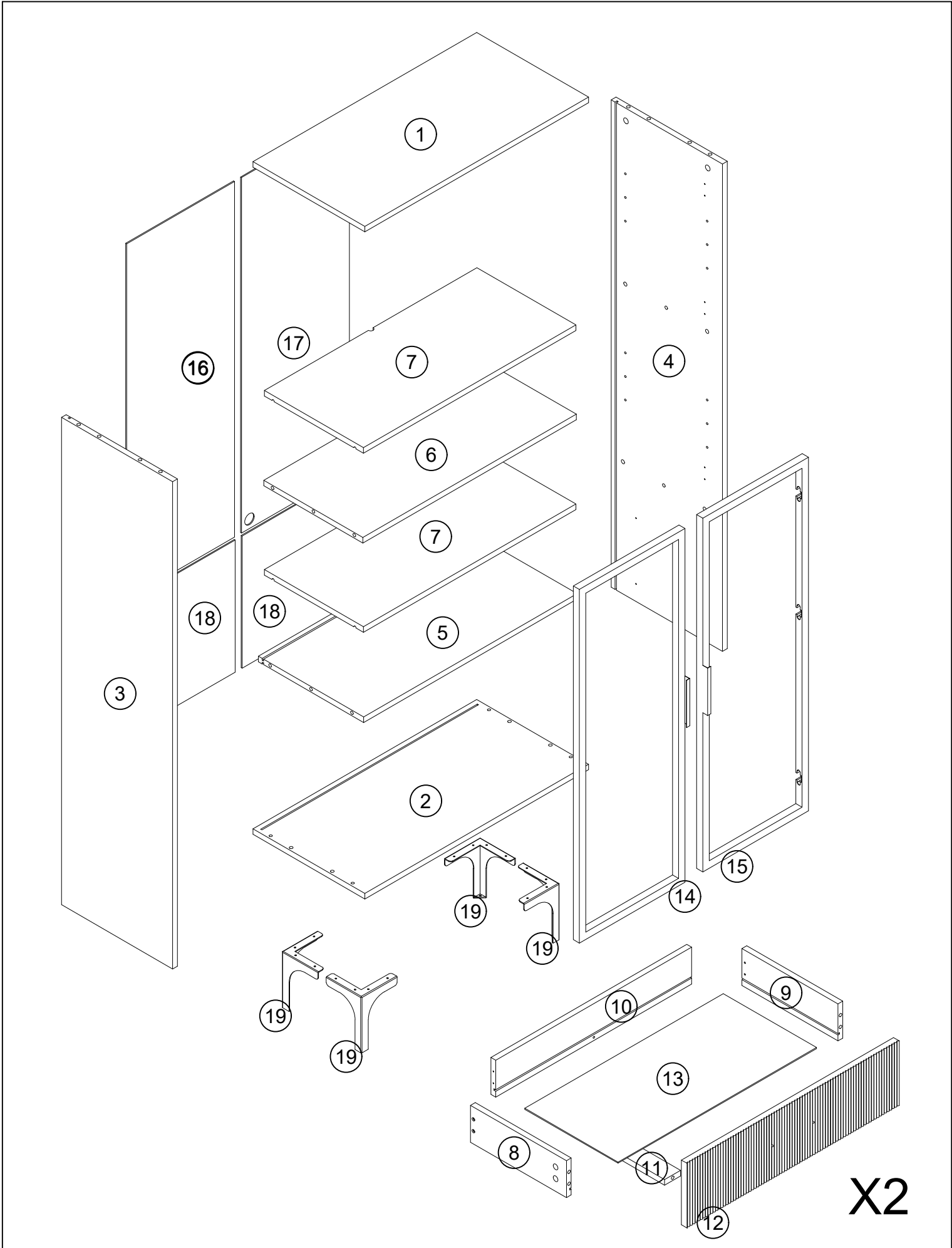

BOX-1 WF322801

3

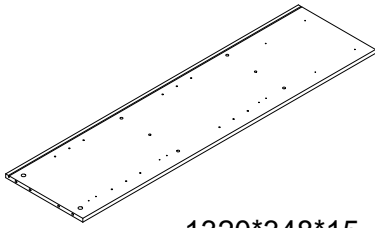

1320*348*15 1

4

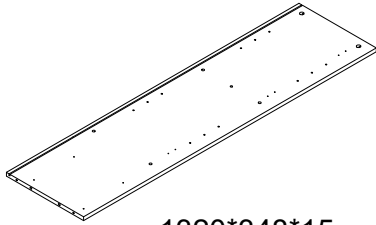

1320*348*15 1

16

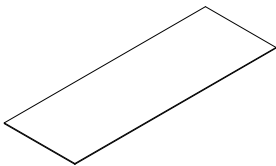

963*337.5*3 1

17

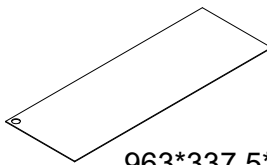

963*337.5*3 1

18

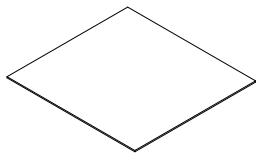

358*337.5*3 2

13

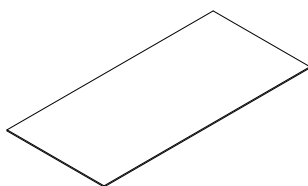

292*621*3 2

BOX-2 WF322802

1

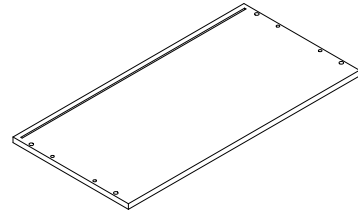

700*350*15 1

2

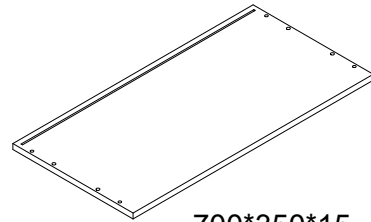

700*350*15 1

5

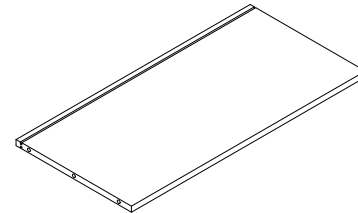

668*329*15 1

6

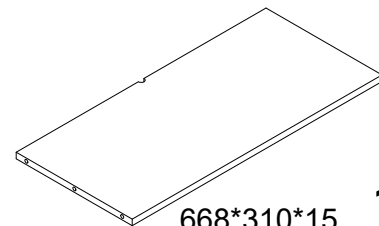

668*310*15 1

7

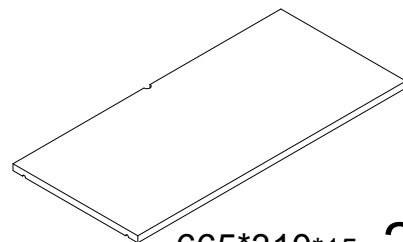

665*310*15 2

12

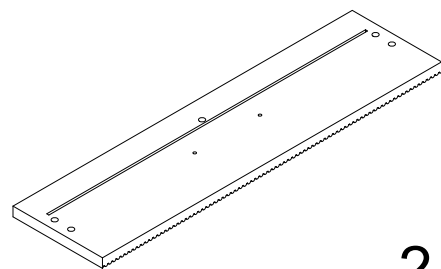

175*664*18 2

BOX-1 WF322801

14

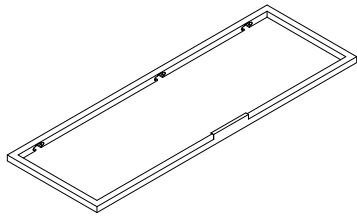

958*330.5*19 **1**

15

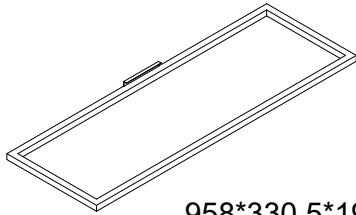

958*330.5*19 **1**

19

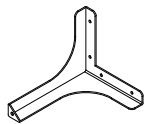

4

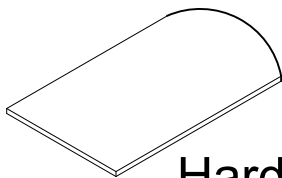

Hardware kit

BOX-2 WF322802

8

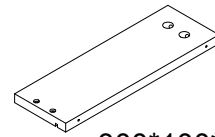

300*100*15 **2**

9

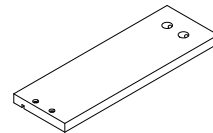

300*100*15 **2**

11

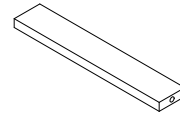





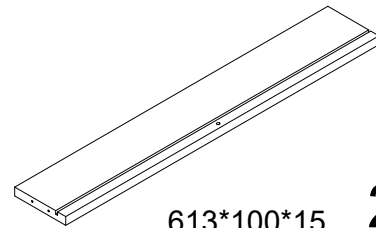





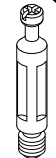

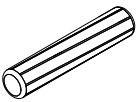

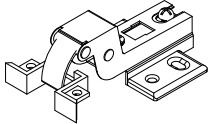

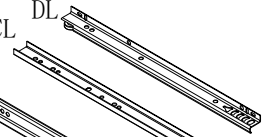
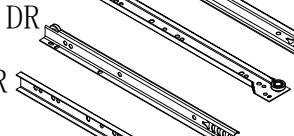
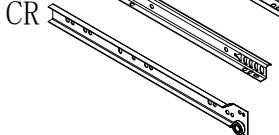
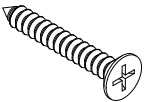
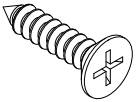

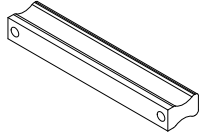
284*50*15 **2**

10

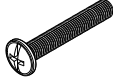

613*100*15 **2**

Hardware List for WF322801/WF322802

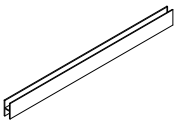
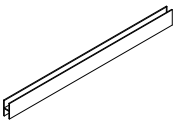
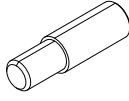
<p>A₁ Ø15*11.5 22PCS</p>  <p>A₂</p>  <p>Ø6*40 22PCS</p>	<p>B</p>  <p>Ø8*40 12PCS</p>	<p>C</p>  <p>M7*50 4PCS</p>	<p>D</p>   <p>6PCS</p>
<p>CL DL</p>  <p>DR</p>  <p>CR</p>  <p>L=300mm 2PCS</p>	<p>F</p>  <p>M3.5*35 10PCS</p>	<p>G</p>  <p>M3.5*14 74PCS</p>	<p>I</p>  <p>18PCS</p>
<p>J</p>  <p>2PCS</p>	<p>K₁ 2PCS</p>  <p>K₂ 2PCS</p>  <p>K₃ 2PCS</p>  <p>K₄ 2PCS</p>  <p>K₅ 2PCS</p> 	<p>L</p>  <p>4PCS</p>	<p>M</p>   <p>1PCS</p>
<p>N</p>  <p>22PCS</p>	<p>O</p>  <p>L=952mm 1PCS</p>	<p>P</p>  <p>L=347mm 1PCS</p>	<p>Q</p>  <p>8PCS</p>

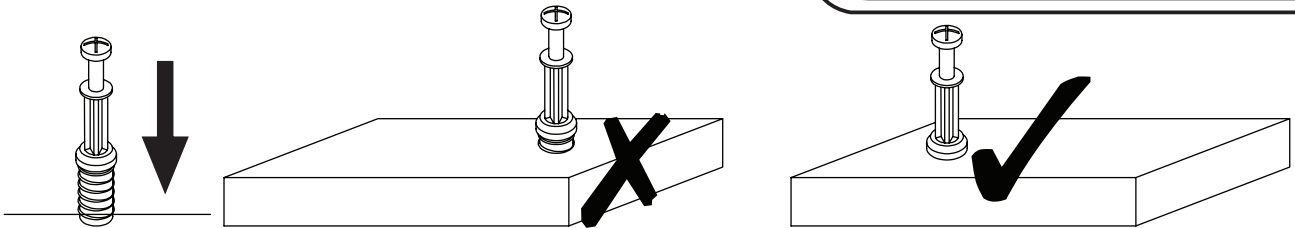

EN_QUICKFIT: Tighten quickfit until shoulder is flush with panel. Do not overtighten or undertighten.

FR_RACCORD RAPIDE: Faites serrer le raccord rapide jusqu'à ce que l'épaulement soit parfaitement encastré dans le panneau. Il ne faut ni trop serrer ni insuffisamment serrer.

ES_QUICKFIT: Apriete quickfit hasta que el hombro se descargue con el panel. NO lo sobreapriete ni lo apriete poco.

DE_QUICKFIT: Ziehen Sie den Quickfit fest, bis die Schulter mit der Platte bündig ist. Bitte nicht zu fest oder zu schwach anziehen.

IT_MONTAGGIO RAPIDO: Stringere il montaggio rapido fino a quando la spalla è a filo con il pannello, non stringere troppo o troppo poco.

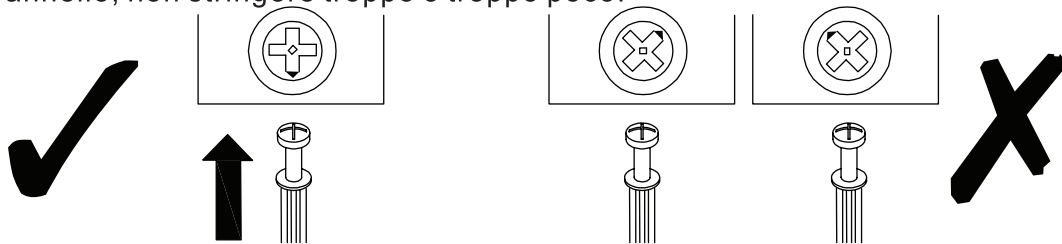

EN_CAM LOCK: When fitting cam lock, ensure starting position is correct before you insert connecting quickfit.

FR_SERRURE BATTEUSE: Avant d'insérer la serrure batteuse, veillez à la bonne orientation avant d'insérer le raccord rapide.

ES_CIERRE DE LA CÁMARA: Cuando instale el cierre de la cámara, asegúrese de que la posición de inicio es correcta antes de que inserte el quickfit conector.

DE_CAM-LOCK: Achten Sie bei der Montage des Cam-Locks auf die richtige Ausgangsposition, bevor Sie den Quickfit einsetzen.

IT_BLOCCAGGIO A CAMMA: Quando si monta il bloccaggio a camma, assicurarsi che la posizione iniziale sia corretta prima di inserire il montaggio rapido di collegamento.

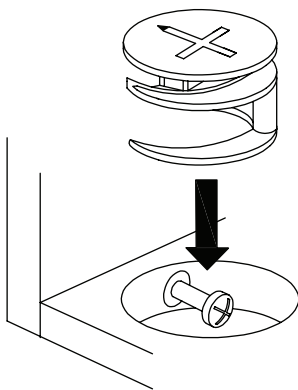

EN_Quickfit head should be in the centre of the cam lock when the two panels are joined.

Cam lock should be inserted before quickfit.

FR_Lorsque les deux panneaux sont assemblés, la tête du raccord rapide doit reposer au centre de la serrure batteuse. Il faut insérer la serrure batteuse avant le raccord rapide.

ES_El cabezal del quickfit debe estar en el centro del cierre de la cámara cuando se unan los dos paneles.

Se debe insertar el cierre de la cámara antes que el quickfit.

DE_Der Quickfit-Kopf sollte sich in der Mitte des Cam-Locks befinden, wenn die beiden Platten zusammengefügt sind.

Der Cam-Lock sollte vor dem Quickfit eingesetzt werden.

IT_La testa del montaggio rapido deve trovarsi al centro del bloccaggio a camma quando i due pannelli sono uniti.

Il Bloccaggio a Camma deve essere inserito prima del montaggio rapido.

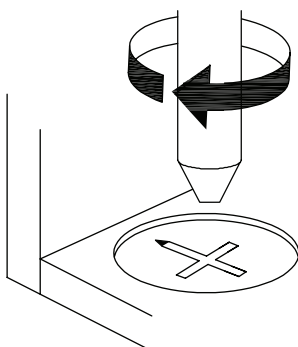

EN_Turn cam lock clockwise to tighten.

FR_Faites tourner la serrure batteuse dans le sens des aiguilles d'une montre pour la resserrer.

ES_Gire el cierre de la cámara en sentido horario para apretarlo.

DE_Drehen Sie den Cam-Lock im Uhrzeigersinn, um ihn festzuziehen.

IT_Ruotare il bloccaggio a camma in senso orario per stringere.

EN It may be necessary to adjust the hinges so that the doors align. Use the instructions below as a guide.

FR Il est parfois nécessaire d'ajuster les charnières pour un meilleur alignement des portes. Servez-vous des instructions ci-dessous comme guide.

ES Puede que sea necesario ajustar los quicios de forma que se alineen las puertas. Use las instrucciones que aparecen debajo como guía.

DE Möglicherweise müssen Sie die Scharniere so einstellen, dass die Türen ausgerichtet sind. Verwenden Sie die nachstehenden Anweisungen als Leitfaden.

IT Potrebbe essere necessario regolare le cerniere in modo che le porte siano allineate. Per fare ciò attenersi alle istruzioni sottostanti.

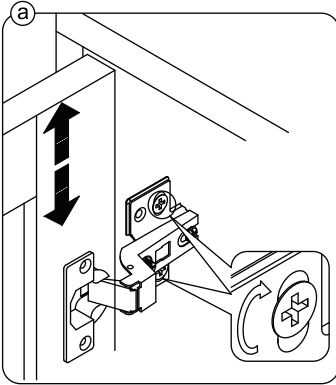

EN To adjust the door vertically loosen the screw as shown and move up and down as needed.

FR Si vous souhaitez régler la porte **verticalement**, desserrez la vis comme indiqué et déplacez la porte de haut en bas selon les besoins.

ES Para ajustar la puerta **verticalmente** afloje el tornillo tal y como se muestra y muévelo hacia arriba o hacia abajo según sea necesario.

DE Um die Tür **vertikal** auszurichten, lösen Sie die Schraube wie abgebildet und bewegen Sie sie nach Bedarf nach oben oder nach unten.

IT Per allineare la porta **verticalmente** allentare la vite come mostrato e spostarla in alto o in basso secondo necessità.

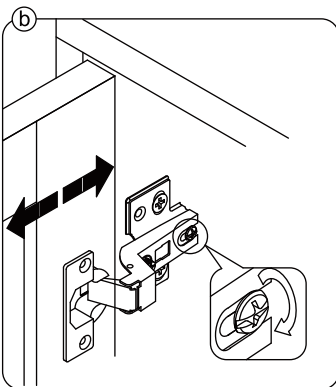

EN To adjust the gap from the door to the main frame turn the screw clockwise or anti-clockwise as needed.

FR Si vous souhaitez ajuster l'**écart** entre la porte et le cadre principal, tournez la vis dans le sens des aiguilles d'une montre ou dans le sens inverse, si nécessaire.

ES Para ajustar el **espacio** desde la puerta al marco principal, gire el tornillo en sentido horario o antihorario, según se necesite.

DE Um den **Abstand** von der Tür zum Hauptrahmen auszurichten, drehen Sie die Schraube je nach Bedarf im oder gegen den Uhrzeigersinn.

IT Per regolare lo **spazio** tra la porta e il telaio principale, avvitare o svitare la vite secondo necessità.

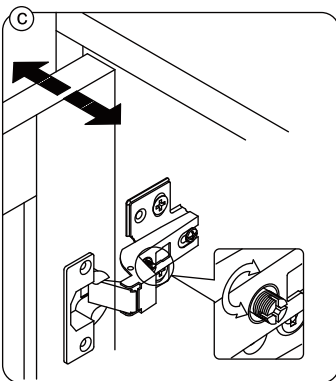

EN To adjust the door laterally adjust the screw as shown by turning clockwise or anti-clockwise.

FR Si vous souhaitez ajuster la porte **latéralement**, ajustez la vis comme indiqué en tournant dans le sens des aiguilles d'une montre ou dans le sens inverse des aiguilles d'une montre.

ES Para ajustar la puerta **lateralmente** ajuste el tornillo tal y como se muestra girándolo en sentido horario y antihorario.

DE Um die Tür **seitlich** auszurichten, stellen Sie bitte die Schraube wie abgebildet durch Drehen im oder gegen den Uhrzeigersinn ein.

IT Per allineare la porta **lateralmente** regolare la vite come mostrato, avvitarandola o svitandola.

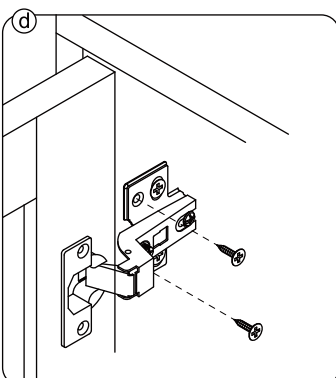

EN Please fix other screws

FR Merci de serrer les autres vis.



ES Fije los demás tornillos

DE Befestigen Sie bitte die anderen Schrauben

IT Fissare le altre viti

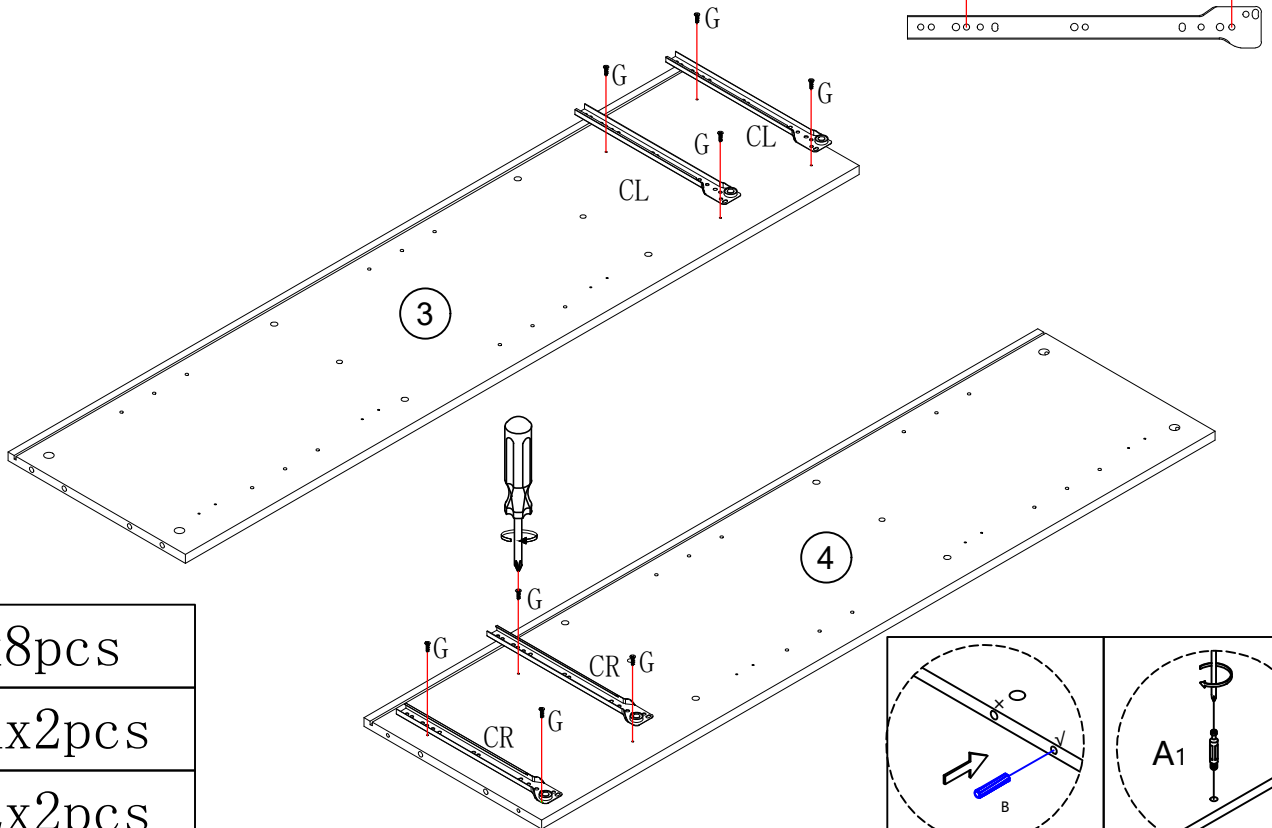

Step 1

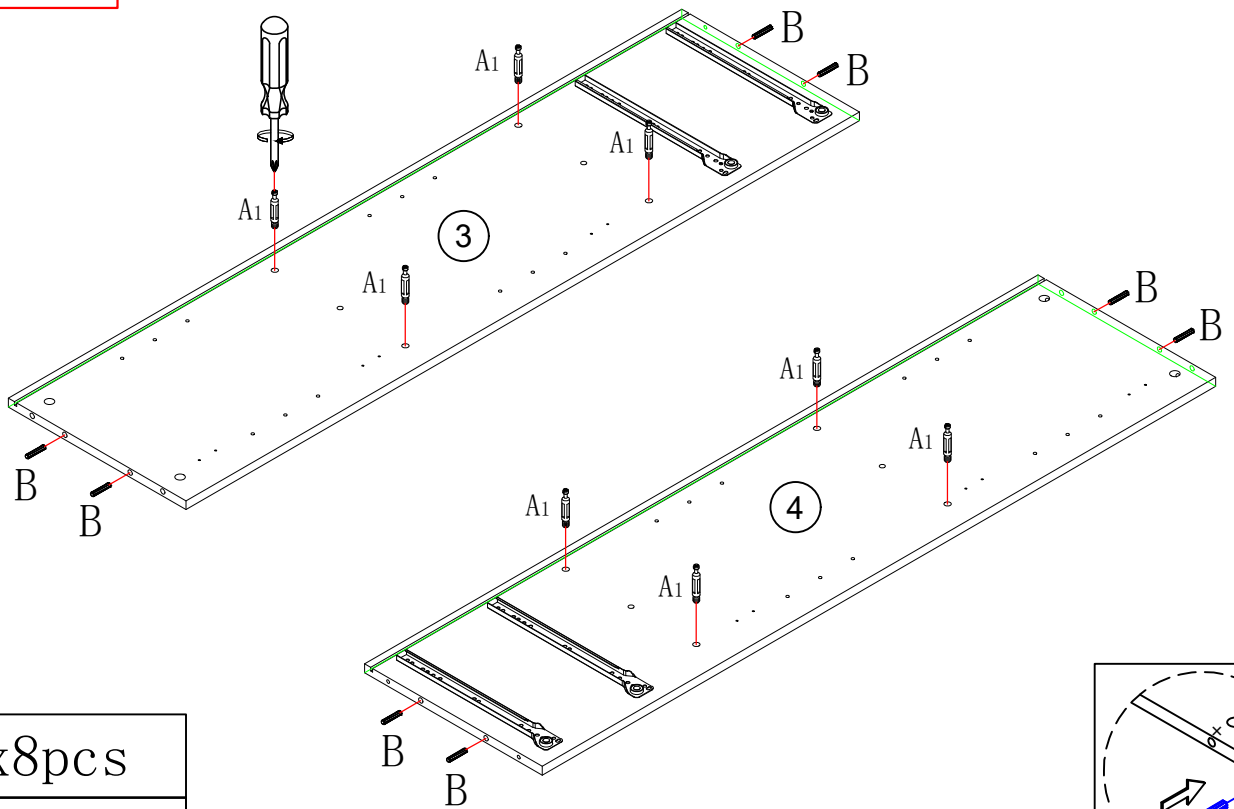

	Gx8pcs
	CRx2pcs
	CLx2pcs

Step 2



	A ₁ x8pcs
	Bx8pcs

Step 3

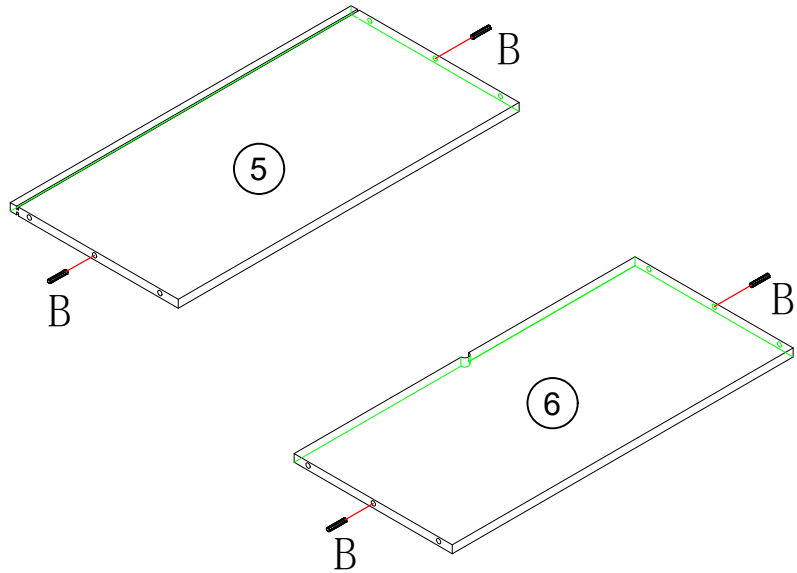

Bx4pcs

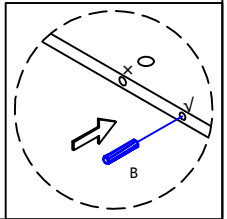

Step 4

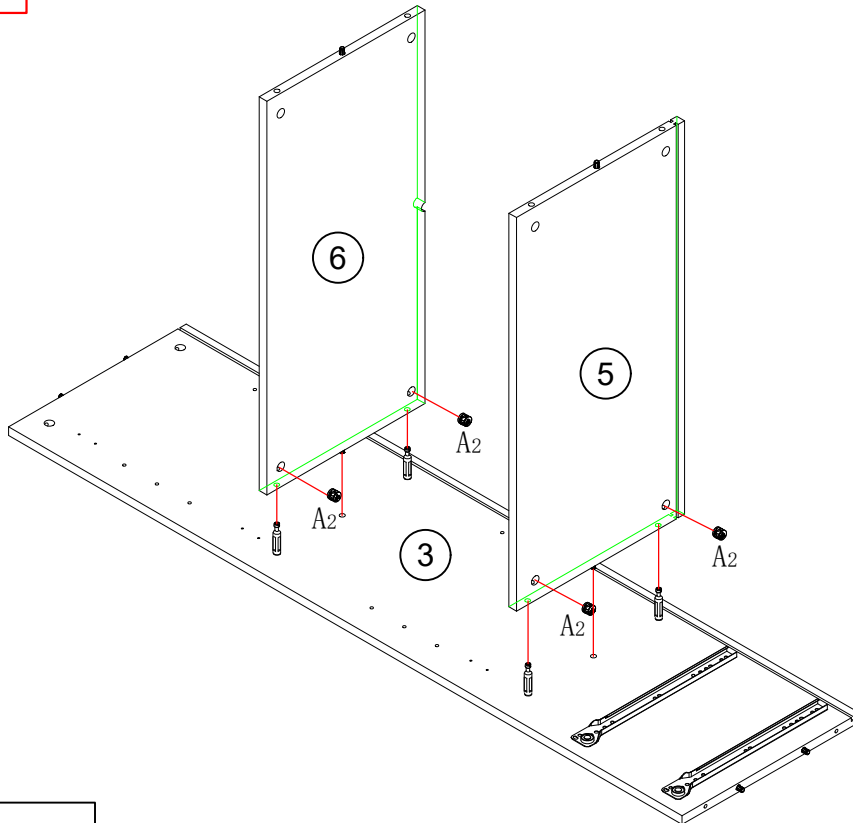

A2x4pcs

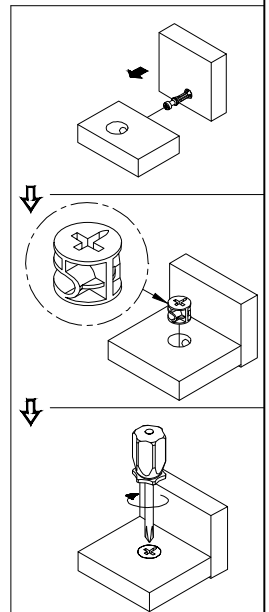

Step 5

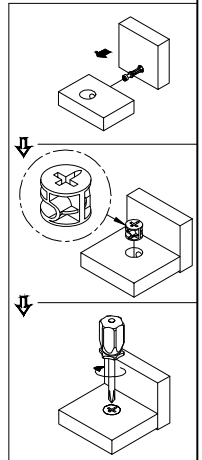
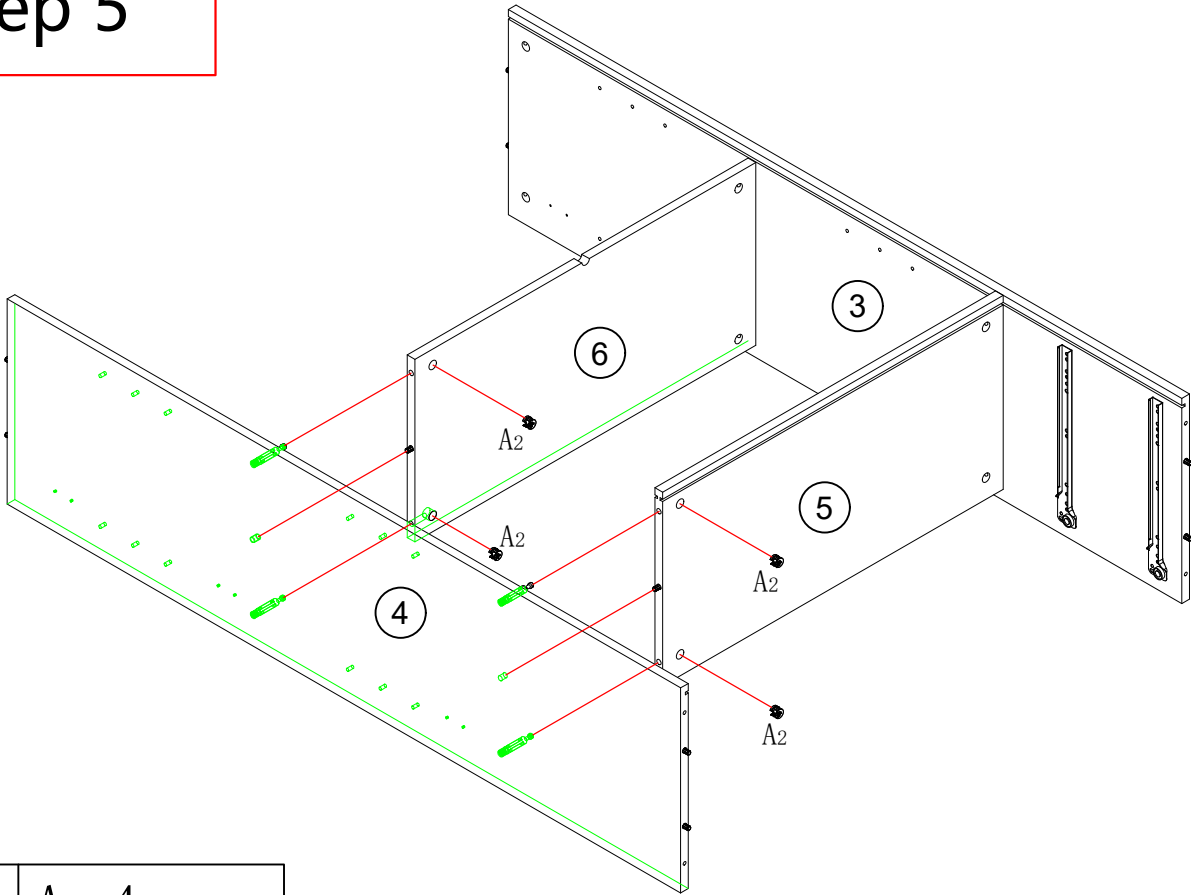

A₂x4pcs

Step 6

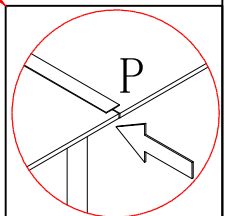
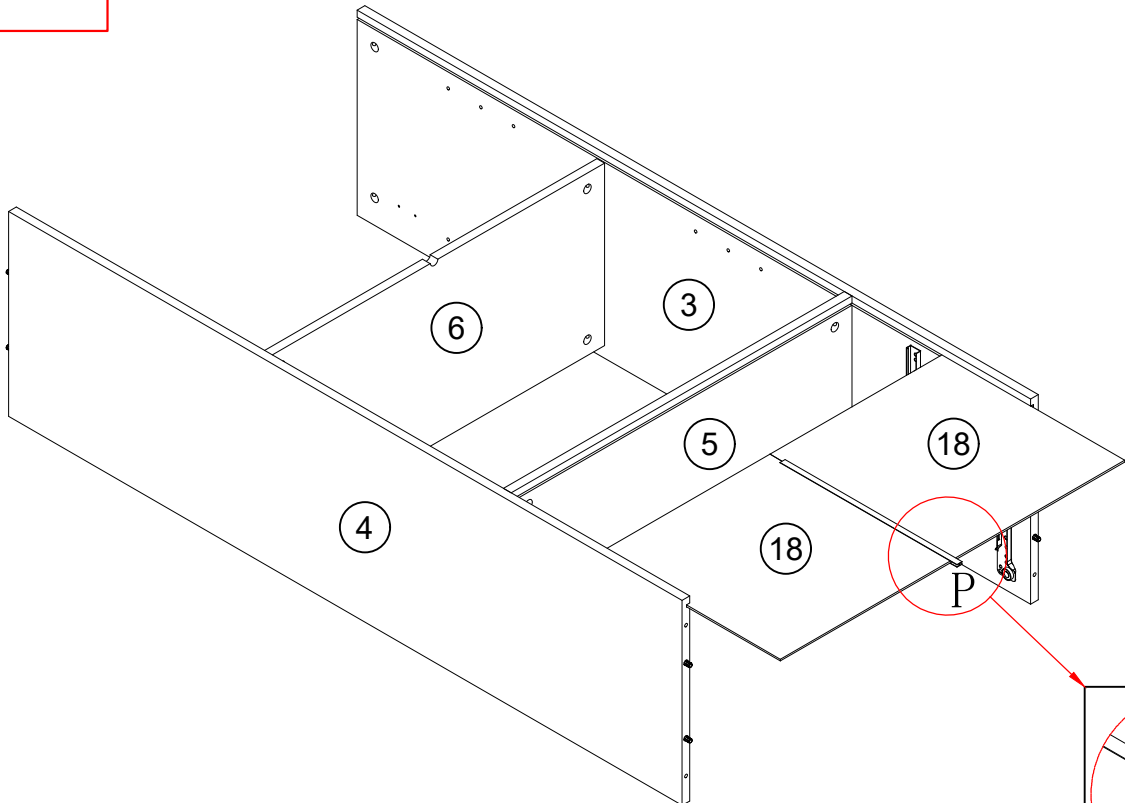

Px1pcs

Step 7

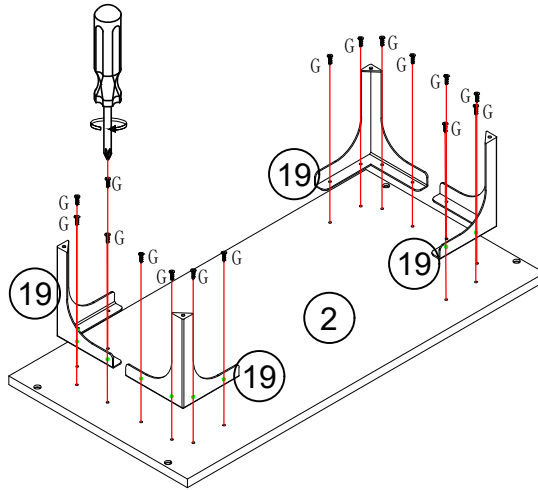

Gx16pcs

Step 8

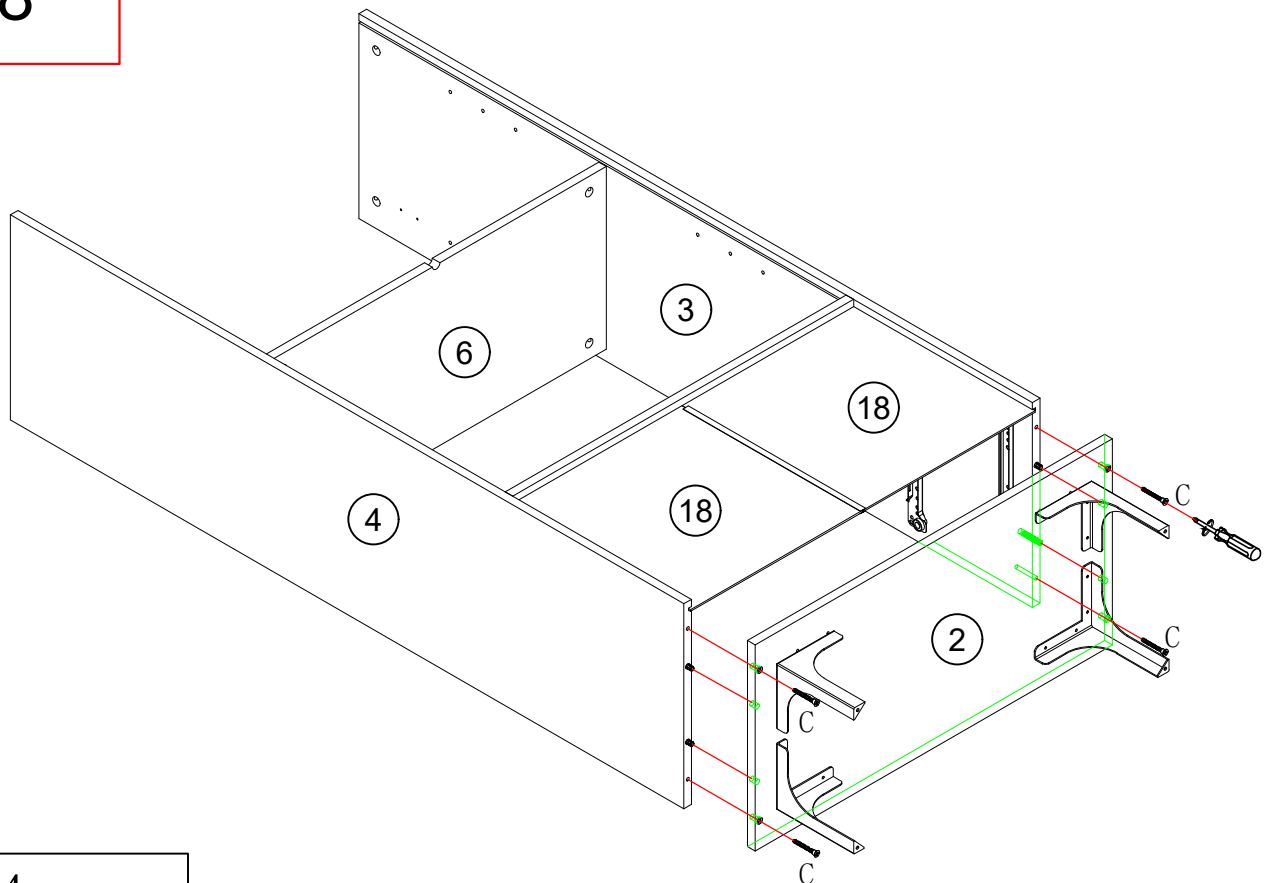

Cx4pcs

Step 9

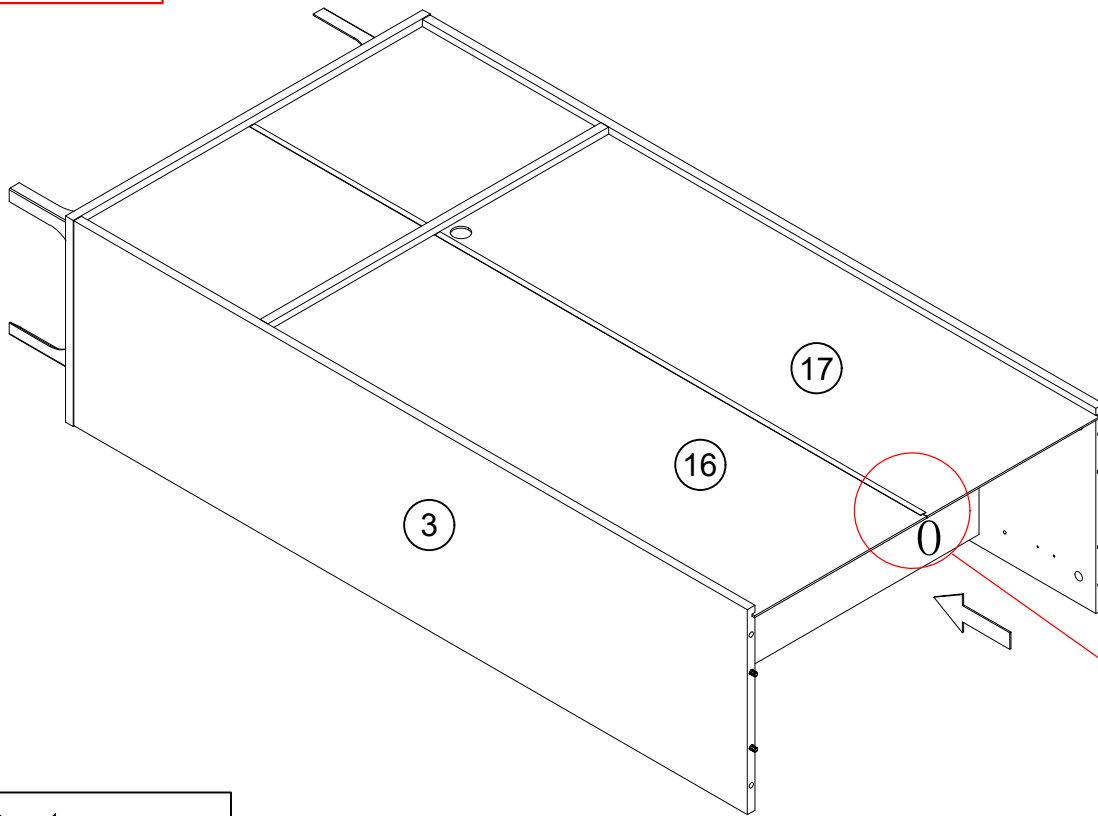

0x1pcs

Step 10

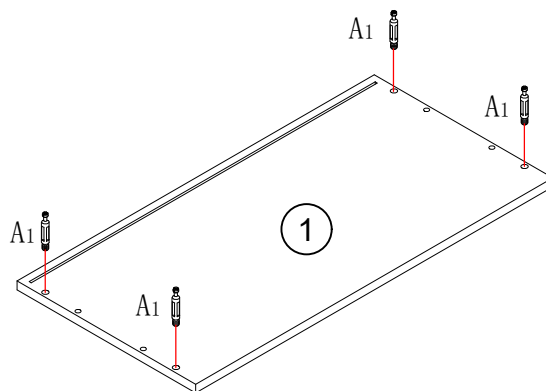

A₁x4pcs

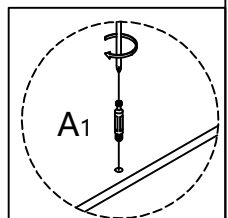

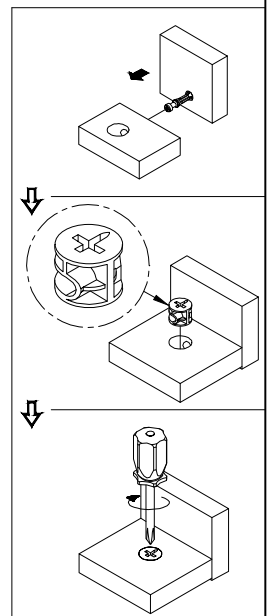
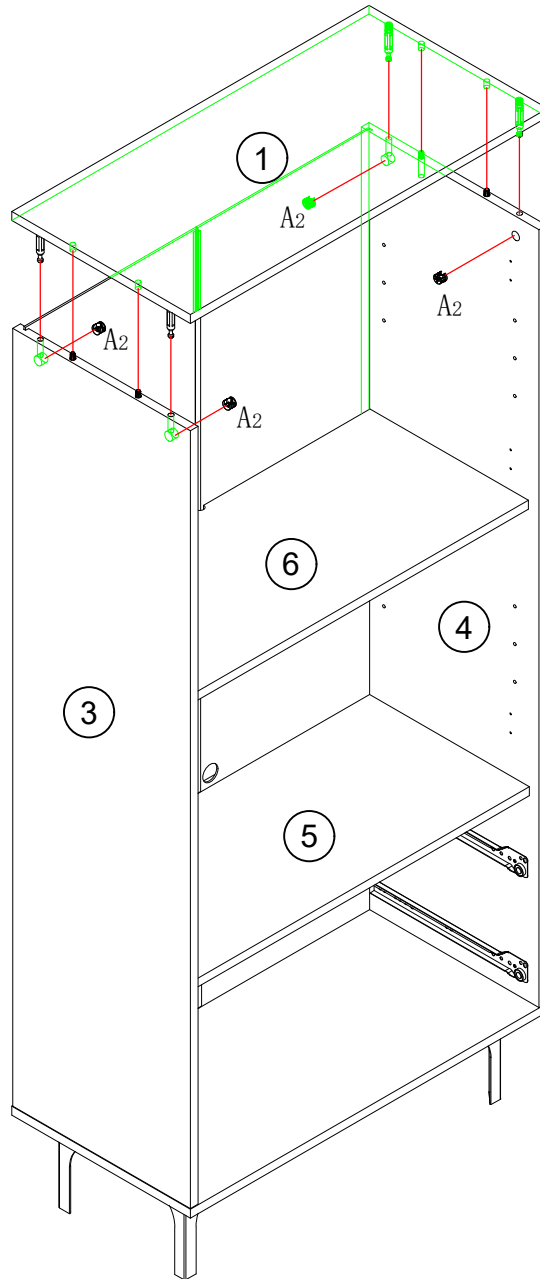

Step 11

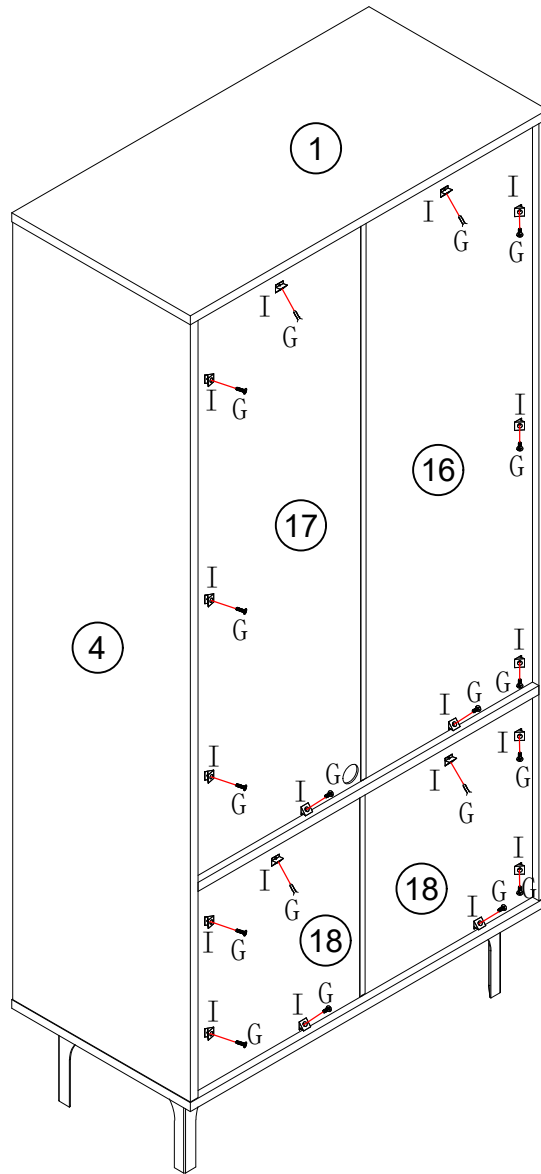

A₂x4pcs

Step 12



	Gx18pcs
	Ix18pcs

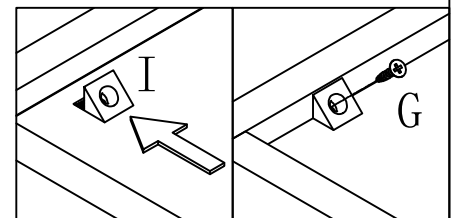

Step 13

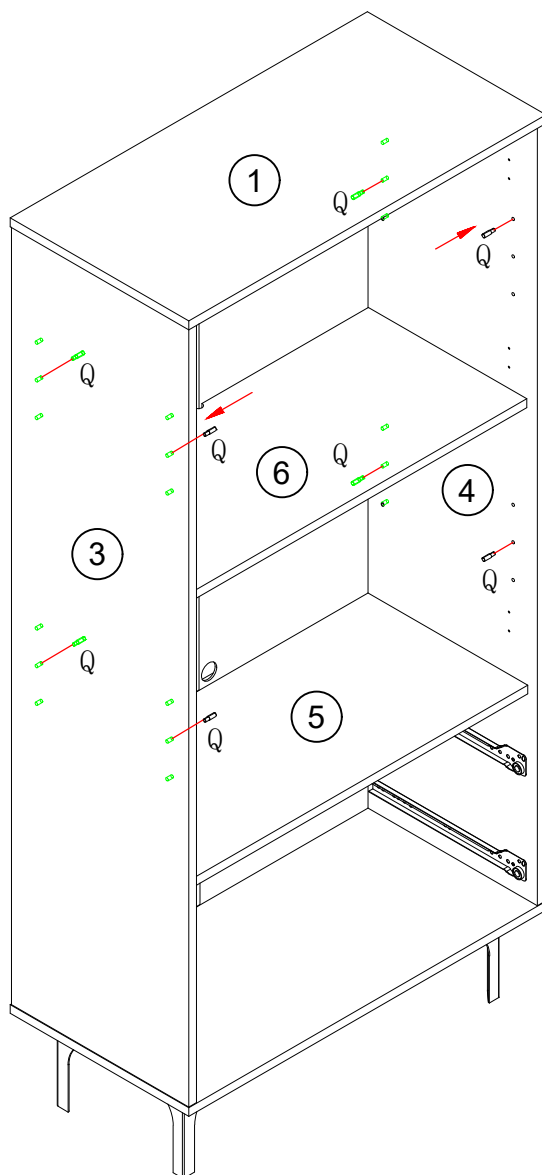

Qx8pcs

Step 14

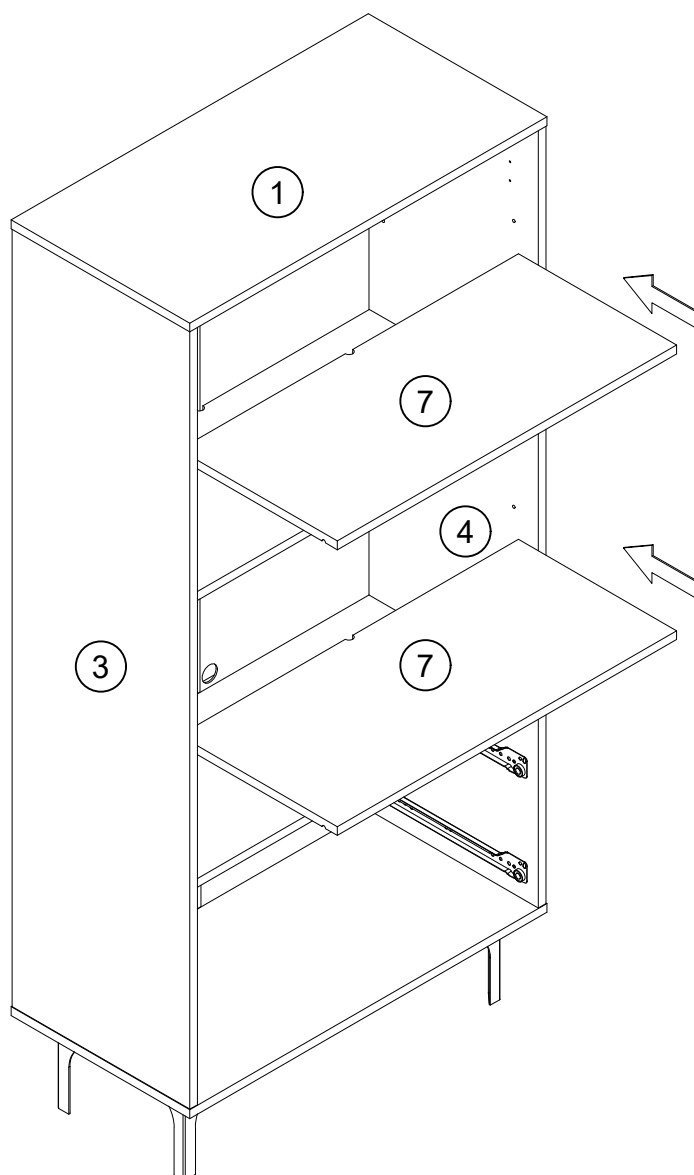

Step 15

UK: Such screws are included in the hinge packaging bag
DE: Solche Schrauben sind in Der Scharnier-Verpackungsbeutel
FR: Ces vis sont incluses dans Le sac d' emballage de charnière

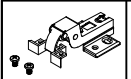
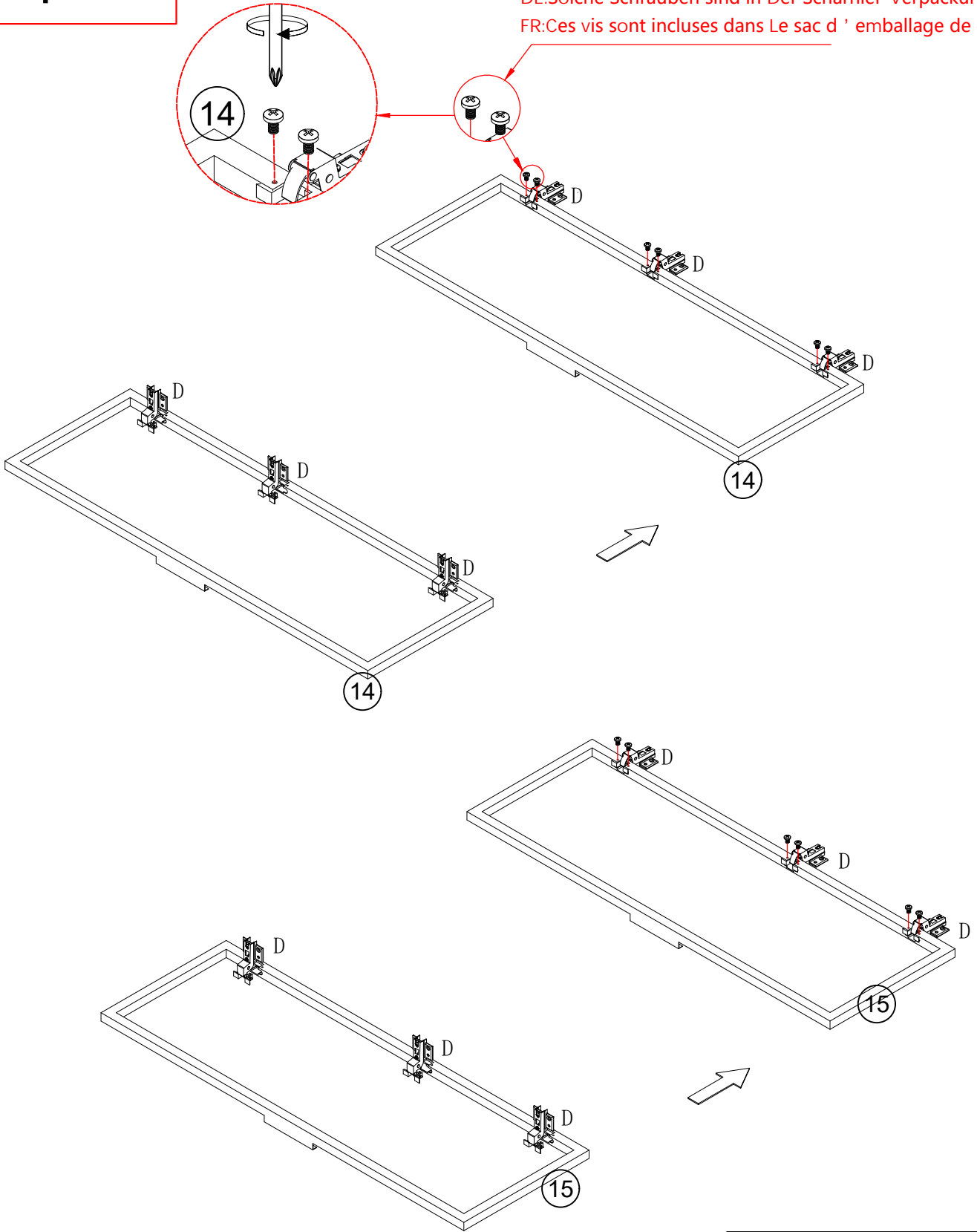

Dx6pcs

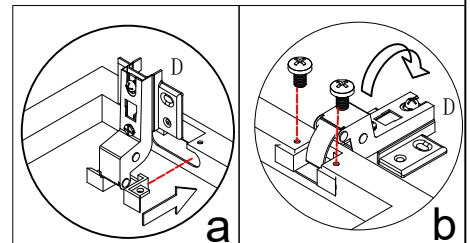

Step 16

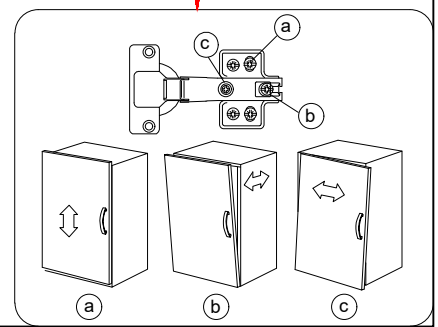
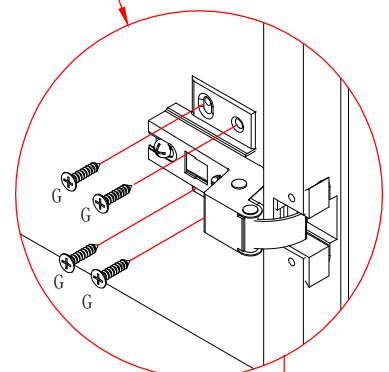
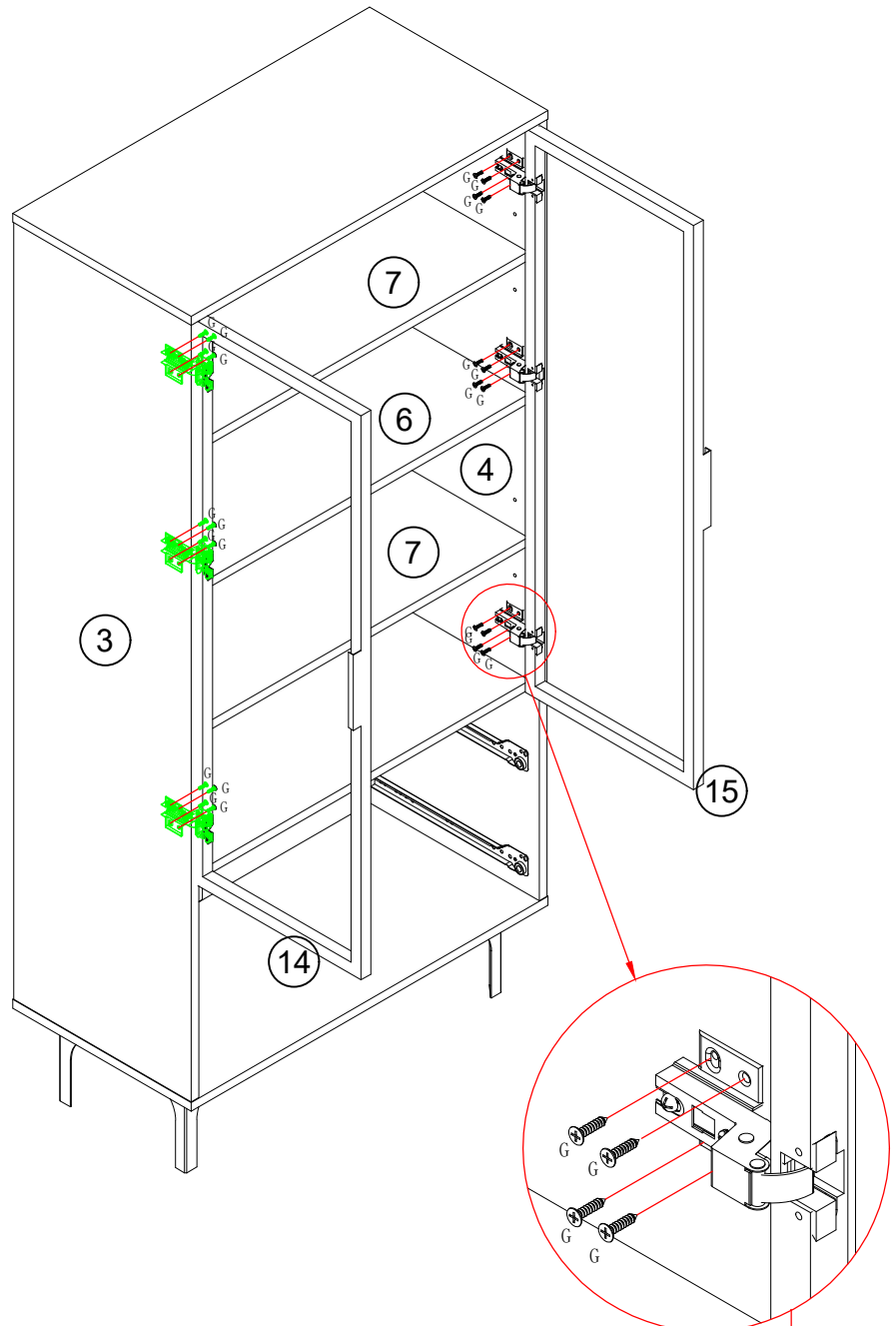

 Gx24pcs

Step 17

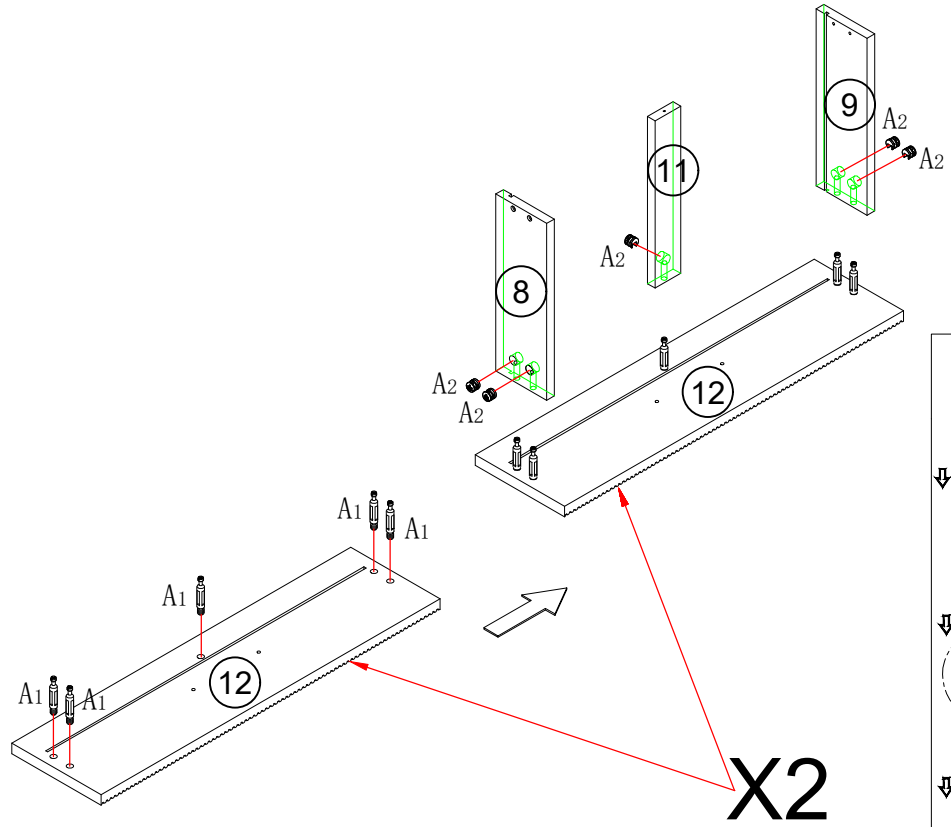

A₁x10pcs



A₂x10pcs

Step 18

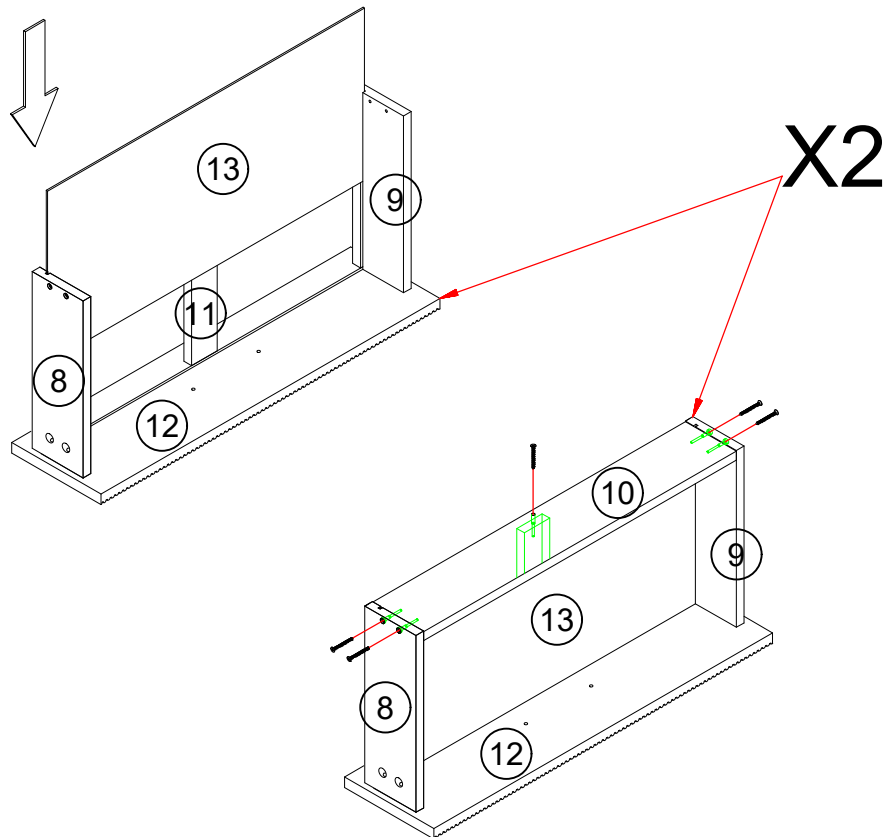

Fx10pcs

Step 19

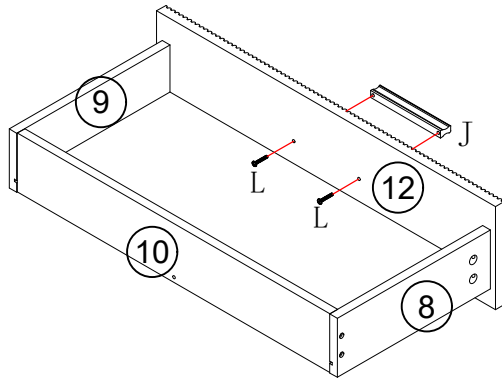

X2



Jx2pcs



Lx4pcs

Step 20

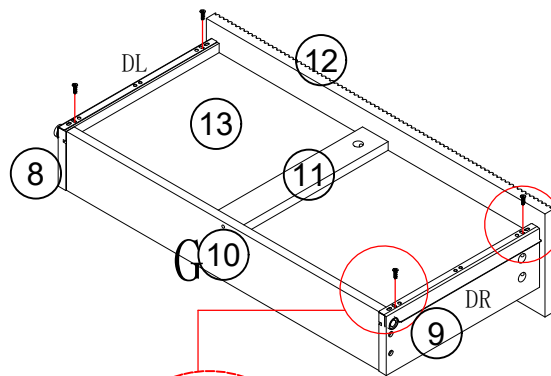

X2



Gx8pcs



DRx2pcs



DLx2pcs

Step 21

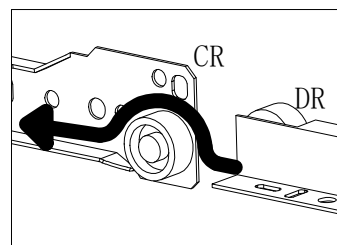
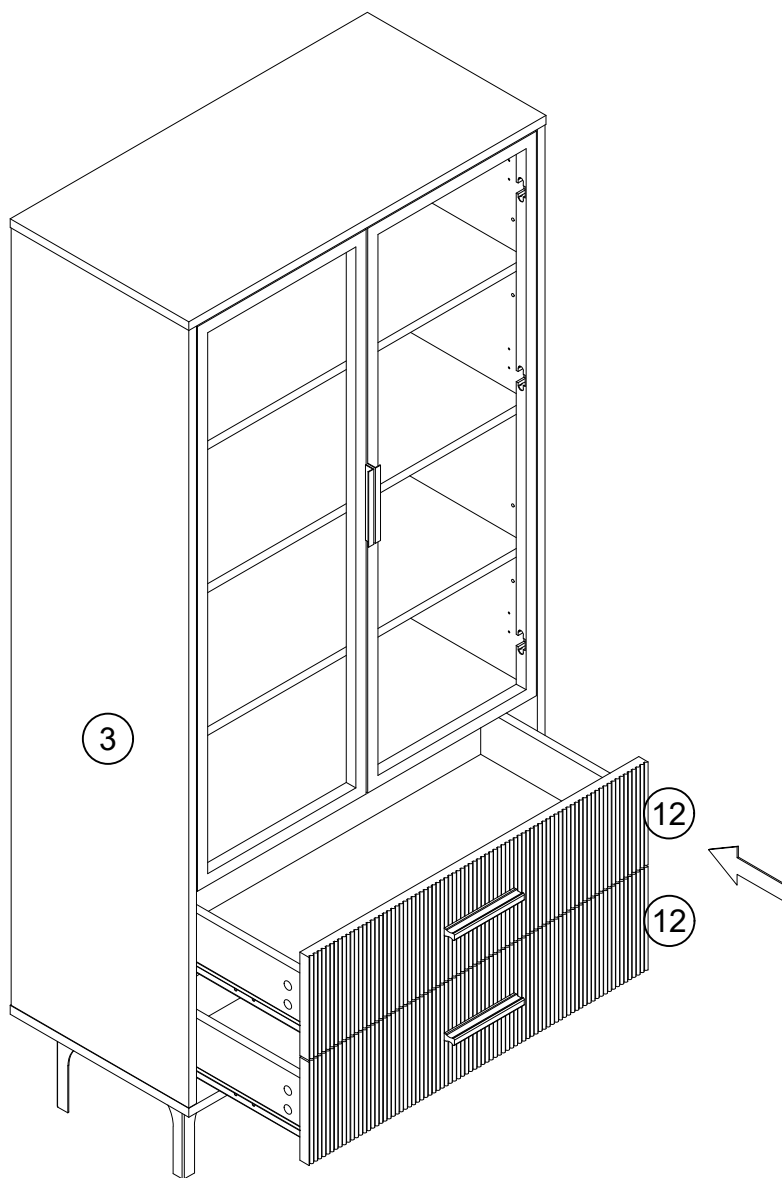

Step 22

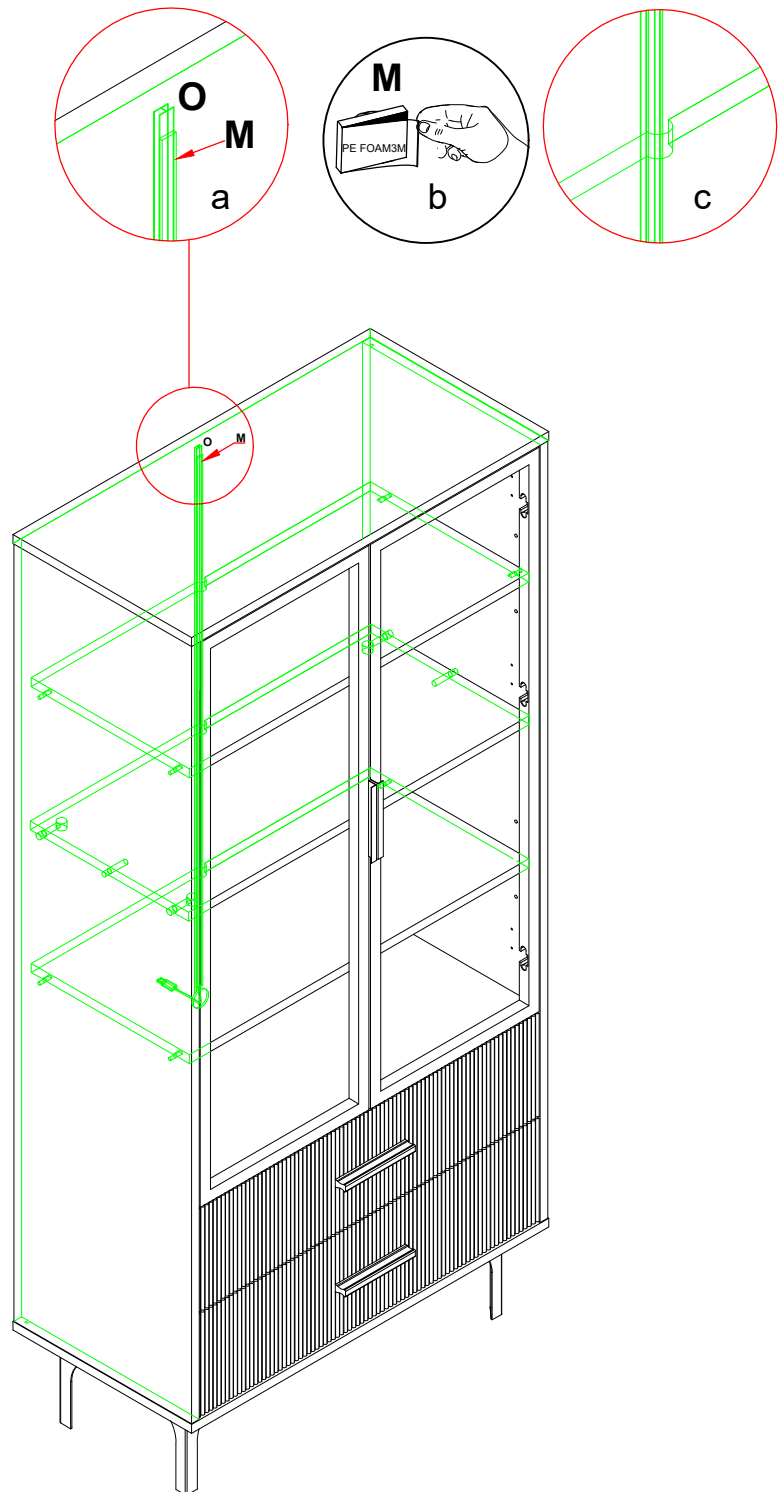

UK:USB connection
FR:Connexion USB
DE:USB-Anschluss





UK:Tear off the back tape
FR:Déchirer le ruban adhésif
arrière
DE:Reiß das hintere Band ab

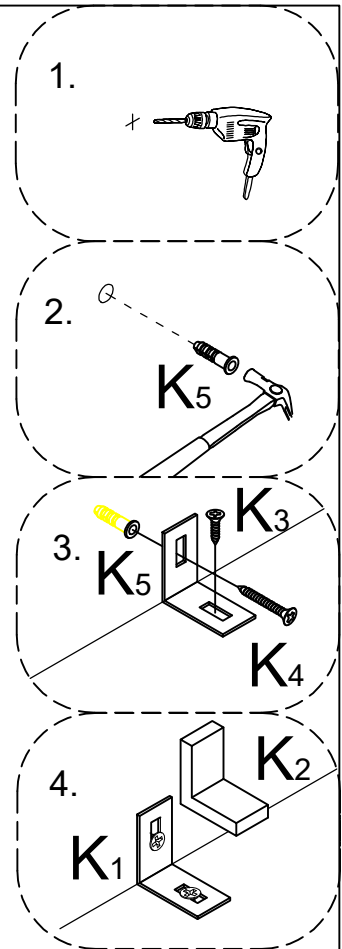
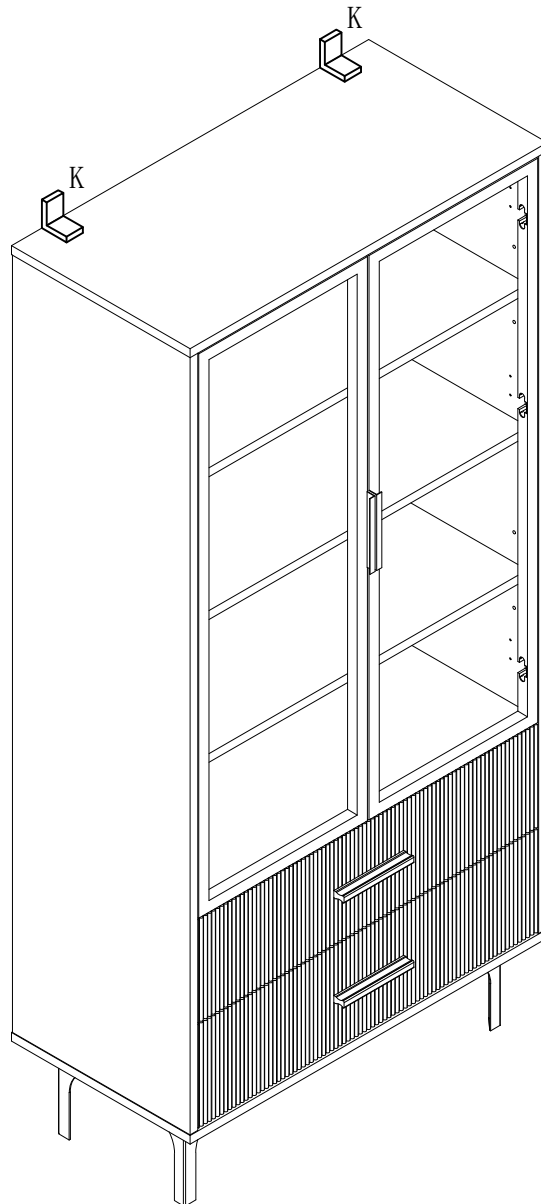

Mx1pcs

Step 23



	K ₁ x2pcs
	K ₂ x2pcs
	K ₃ x2pcs
	K ₄ x2pcs
	K ₅ x2pcs

EN If it is a solid wal, please use expansion and self-tapping screws, if it is a wooden wall, only use

self-tapping screws, please do not overtighten the screws

FR Si le mur est massif, veuillez utiiser des chevllles a expansion et des vis autotaraudeuses. mais sis'agit dun mur en bois, utilisez uniquement des vis autotaraudeuses et ne serrez pas trop les vis.

ES Para una pared solida, utilice los tomillos de expansion y autorroscantes. Para una pared demadera, utilice exclusivamente los tornillos autorroscantes, no los apriete demasiado.

DE Wenn es sich um eine Massiwand handelt, verwenden Sie bitte Dehnungs- und selbstschneidende Schrauben. Wenn es sich um eine Holzwand handelt, verwenden Sie nur selbstschneidende Schrauben, bitte ziehen Sie die Schrauben nicht zu fest an.

IT Se si tratta di un muro solido, utilizzare sia viti ad espansione che autofiettant. Se si tratta di unaparete in legno, utizzare solo viti autofilettanti, non stringere eccessivamente le viti.

Step 24

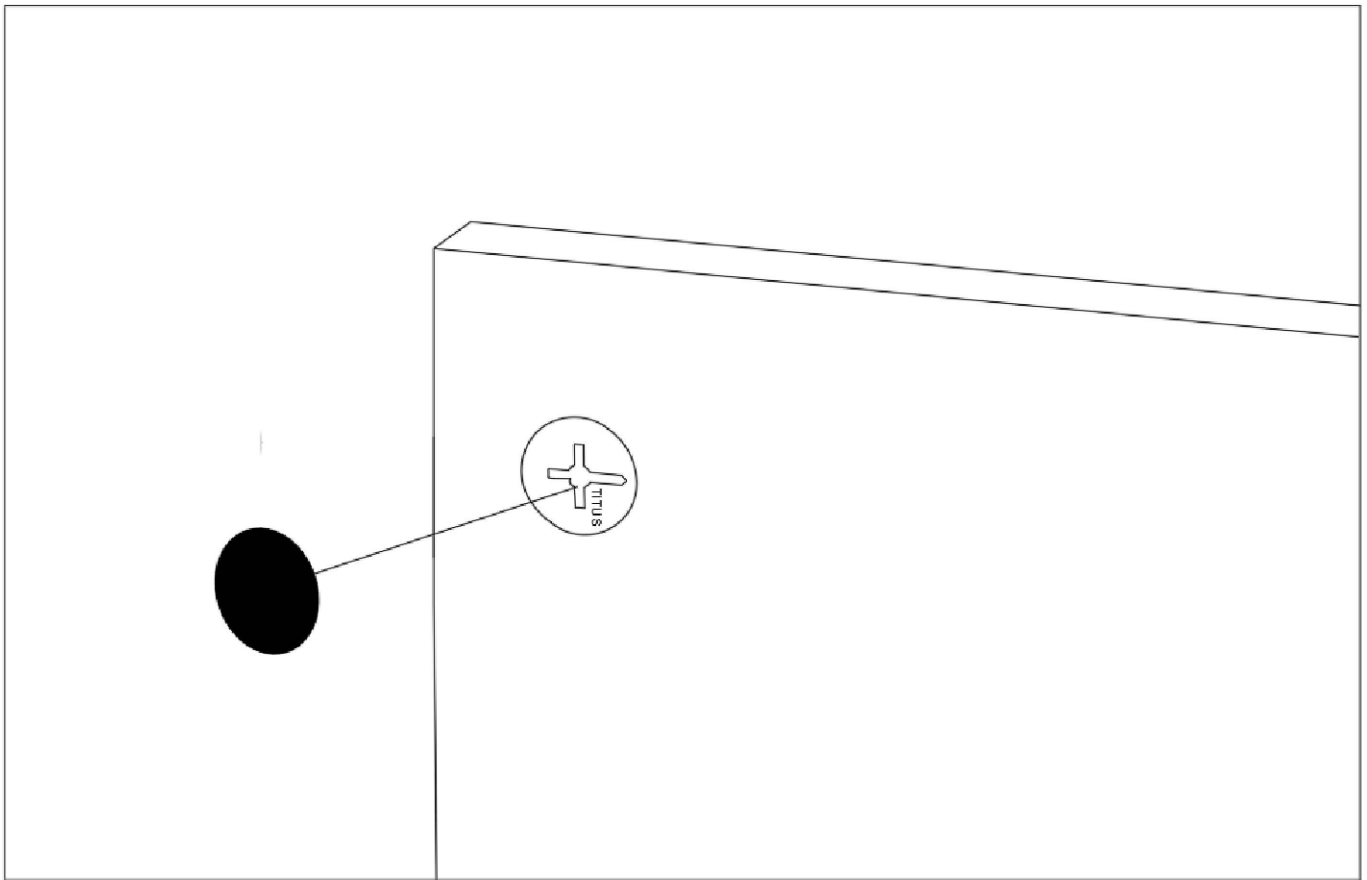

UK: After installing the product, stick the number L on the perforated position

FR: Une fois le produit installé, collez le numéro L à l'endroit où il y a des trous

DE: Nach der Installation des Produkts kleben Sie die Nummer L auf die perforierte Position



Nx22pcs

DE: Wenn Sie die Lichter nicht erfolgreich arbeiten lassen können, überprüfen Sie bitte die Folgendes:

1. Bitte überprüfen Sie die Fernbedienung. Sie müssen die Fernbedienung abreißen Plastikseptum vor Gebrauch.
2. Lassen Sie die Fernbedienung nicht zu weit vom Empfänger entfernt sein Es gibt kein Hindernis zwischen ihnen.
3. Bitte beachten Sie, dass die Fernbedienung für den Transport keine Batterien enthält. Das Batteriemodell lautet: CR2025

FR: Si vous ne parvenez pas à faire fonctionner les lumières correctement, veuillez vérifier les points suivants?:

1. Veuillez vérifier la télécommande. Vous devez retirer le septum en plastique de la télécommande avant utilisation.
2. Ne laissez pas la télécommande être trop éloignée du récepteur. Il n'y a aucun obstacle entre eux.
3. Veuillez noter que la télécommande ne contient pas de piles pour le transport. Le modèle de batterie est?: CR2025

UK: If you can't make the lights work successfully, please check the following:

1. Please check the remote control. You need to tear off the remote plastic septum before use.
2. Don't let the remote control be too far from the receiver There is no obstacle between them.
3. Please note that the remote control does not contain batteries for transportation. The battery model is: CR2025

NOTE: The battery in the remote control requires you to purchase and install it yourself.
Model: CR2025 3. V

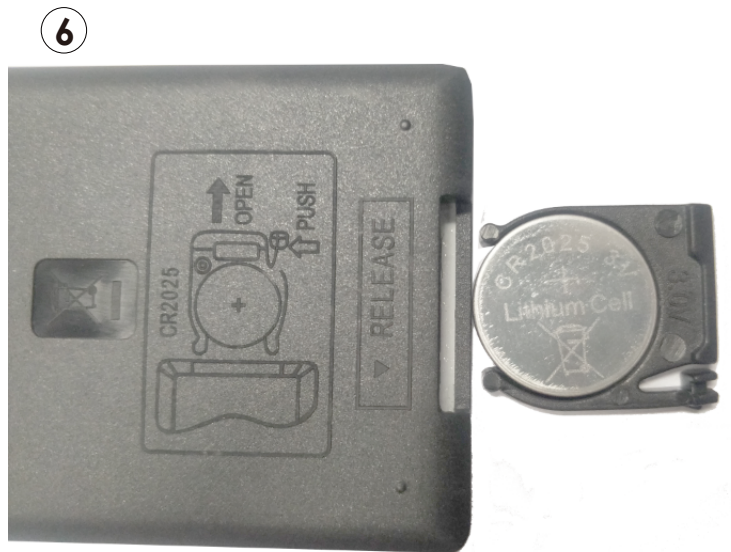
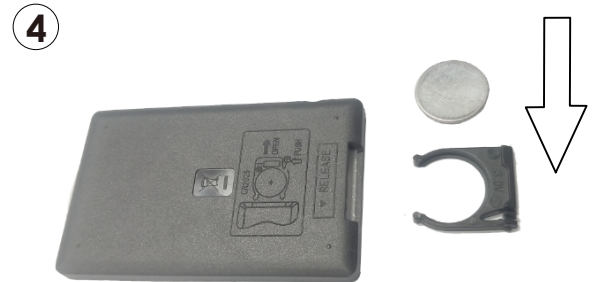

Modell : CR2025 3.V

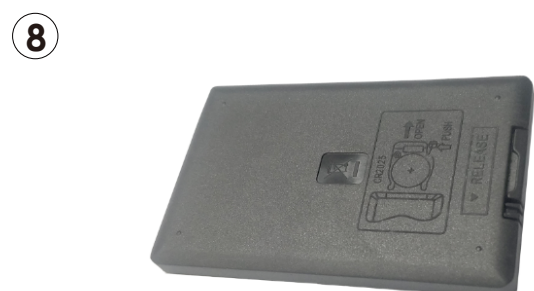



Certificate Number: HW20200902023E
EMC Directive 2014/30/EU

Certificate Of Compliance

Applicant : Hanron Lighting Co., Limited
3/F, NO.1, Jintai Road, Second Industrial Park, Shangwu
Address : Community, Shiyan, Bao'an District, Shenzhen,
Guangdong, 518108, China
Manufacturer : Hanron Lighting Co., Limited
3/F, NO.1, Jintai Road, Second Industrial Park, Shangwu
Address : Community, Shiyan, Bao'an District, Shenzhen,
Guangdong, 518108, China
Product : LED Strip Light
Model No. : HR00-B, HR00-A, HR00-C, HR00-D, HR00-F, HR00-G,
HR00-H, HR00-I

The submitted products have been tested by us with the following standard(s) and found to be in compliance with the listed European Directives.

EN 55015:2013+A1:2015;
EN 61000-3-2:2014;
EN 61000-3-3:2013;
EN 61547:2009

The test results apply only to the particular sample tested and to the specific tests carried out. Technical Report and documentation are at the Holder's disposal.
This certificate applies specifically to the sample investigated in our test reference number only. The CE markings as shown below can be affixed on the product after preparation of necessary technical documentation. Other relevant Directives have to be observed.

CE



Manager: Guy Su
Date: September 2, 2020

Shenzhen Huawin Testing Certification Co., Ltd.

Add: 7F, Building A, Shenye U Center, No. 743, Zhoushi Road, Bao'an District, Shenzhen, China

Http://www.huawinlab.com E-mail: info@huawinlab.com