

- EN To deodorize the leather leave the chair in a shady outside for 1-2 days.
- DE Um den Ledergeruch zu entfernen, lassen Sie den Stuhl 1-2 Tage an einem schattigen Ort im Freien stehen.
- FR Pour désodoriser le cuir, laissez la chaise à l'extérieur dans un endroit ombragé pendant 1 à 2 jours.

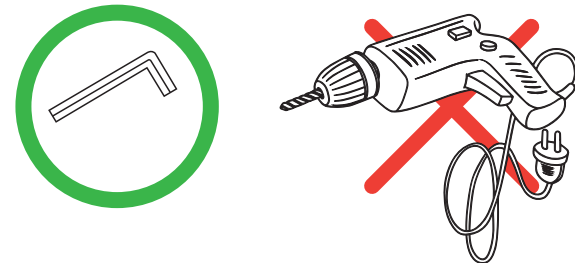

- EN Tighten bolts periodically.
- DE Ziehen Sie die Schrauben regelmäßig nach.
- FR Serrez périodiquement les boulons.



Safety Information



DUMOS[®] INSTRUCTION MANUAL

Model: C-DJY01













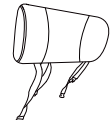
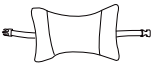
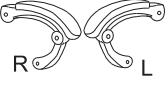



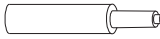

DUMOS[®]

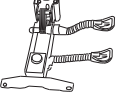
INSTRUCTION MANUAL

C-DJY01

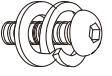

Part List

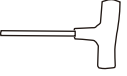
 (A)*1	 (B)*1	 (C)*1	 (D)*1	 (E)*2	 (F)*1
 (G)*1	 (H)*2	 (I)*5	 (J)*1	 (K)*5	 (L1)*1
 (L2)*1	 (M)*1	 (N)*1	 (O)*6 M6*25mm	 (P)*4 M8*25mm	 (Q)*8 M8*20mm
 (R)*10 M6*10mm	 (S)*4 M8*40mm	 (T)*1 M5*10mm	 (U)*1		

Assembly Instruction

Step 1

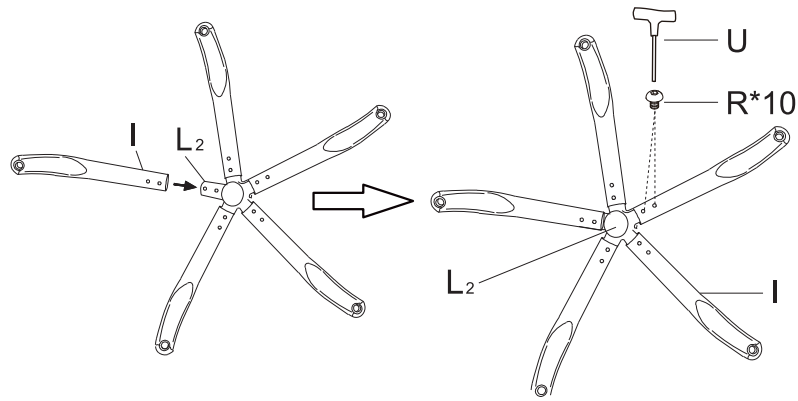
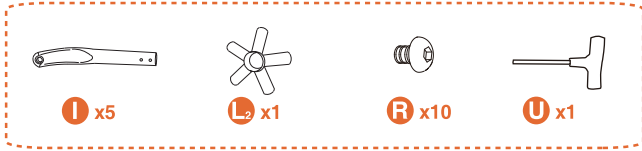

Step 2

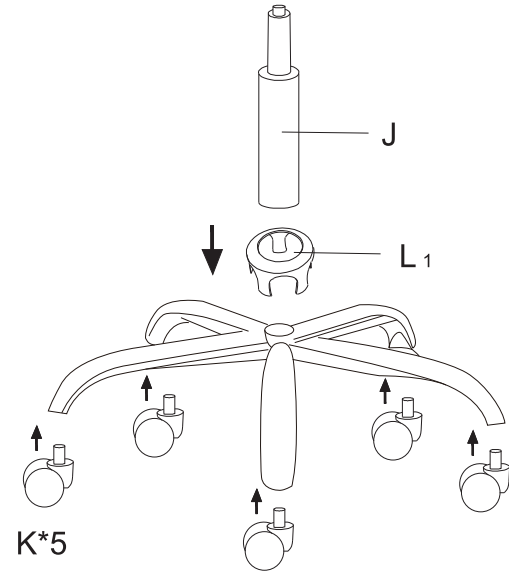

Step 5

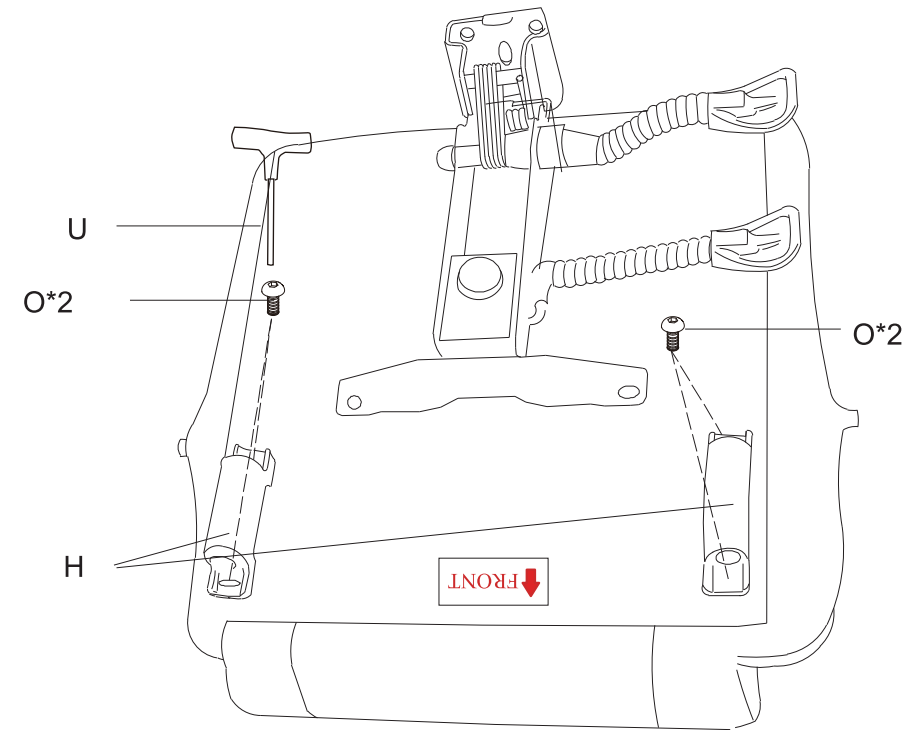
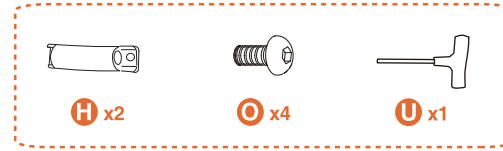

Step 3

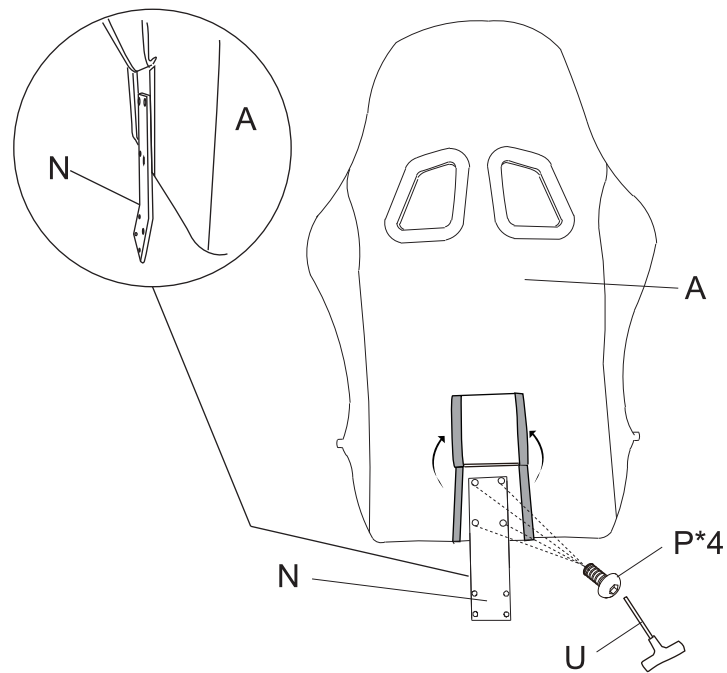
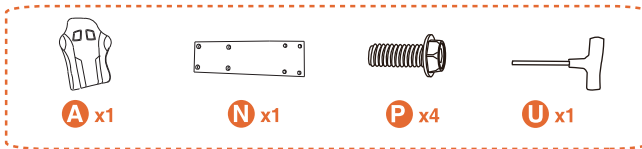

Step 4

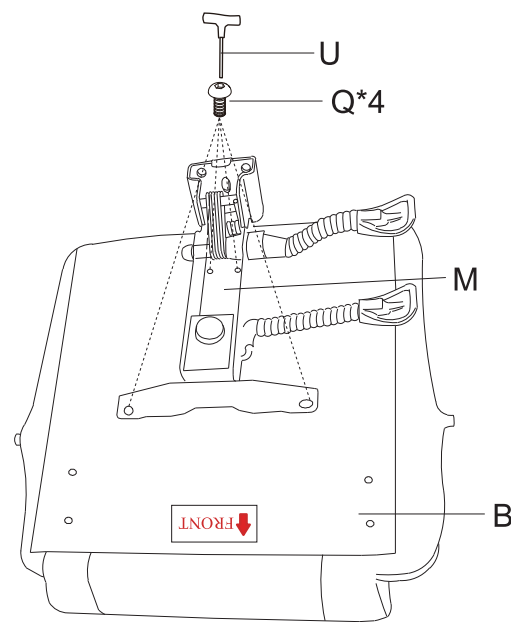
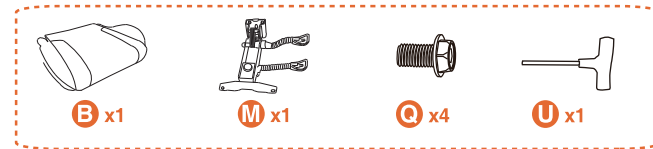

Step 6

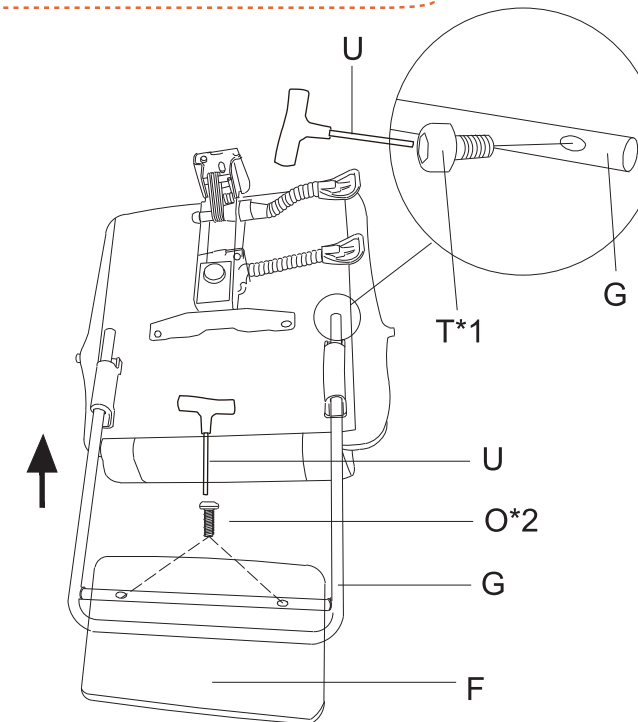
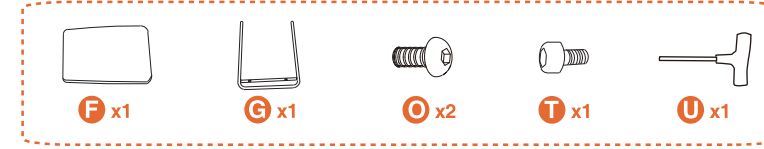

Step 7

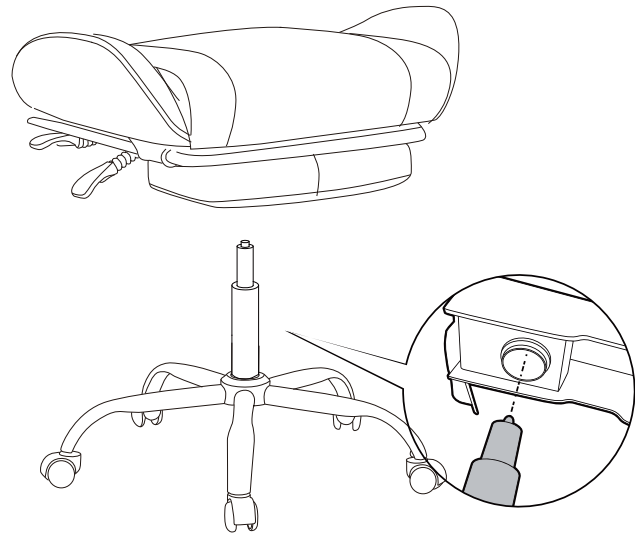

Step 8

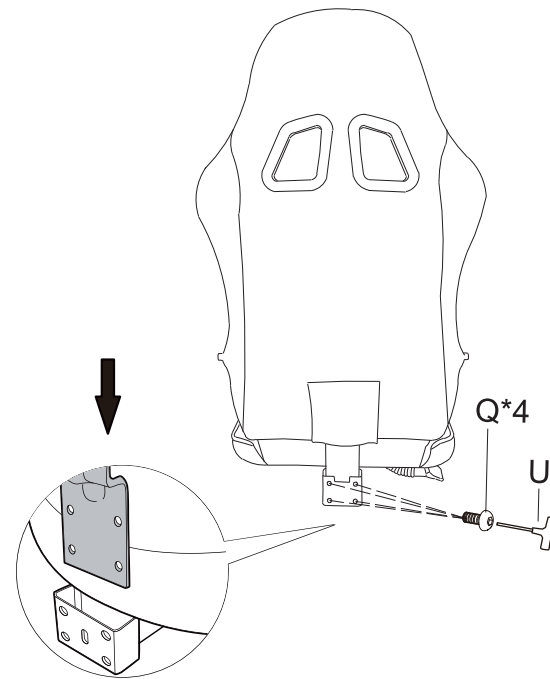
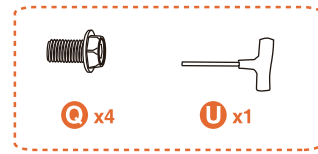

Step 10

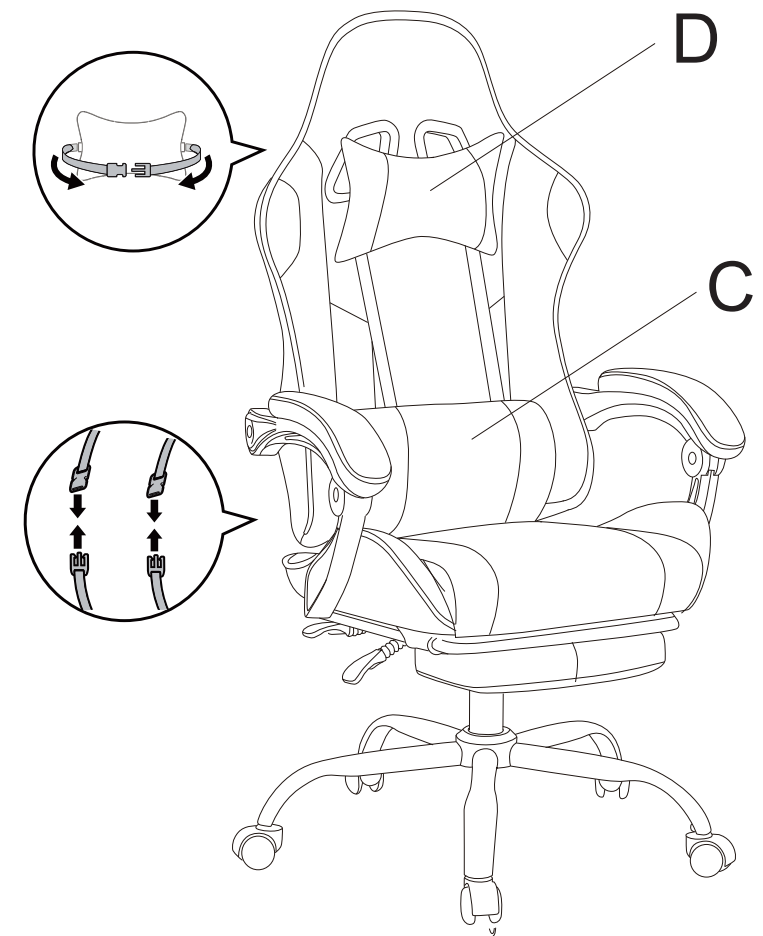
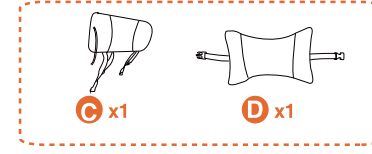

Step 9

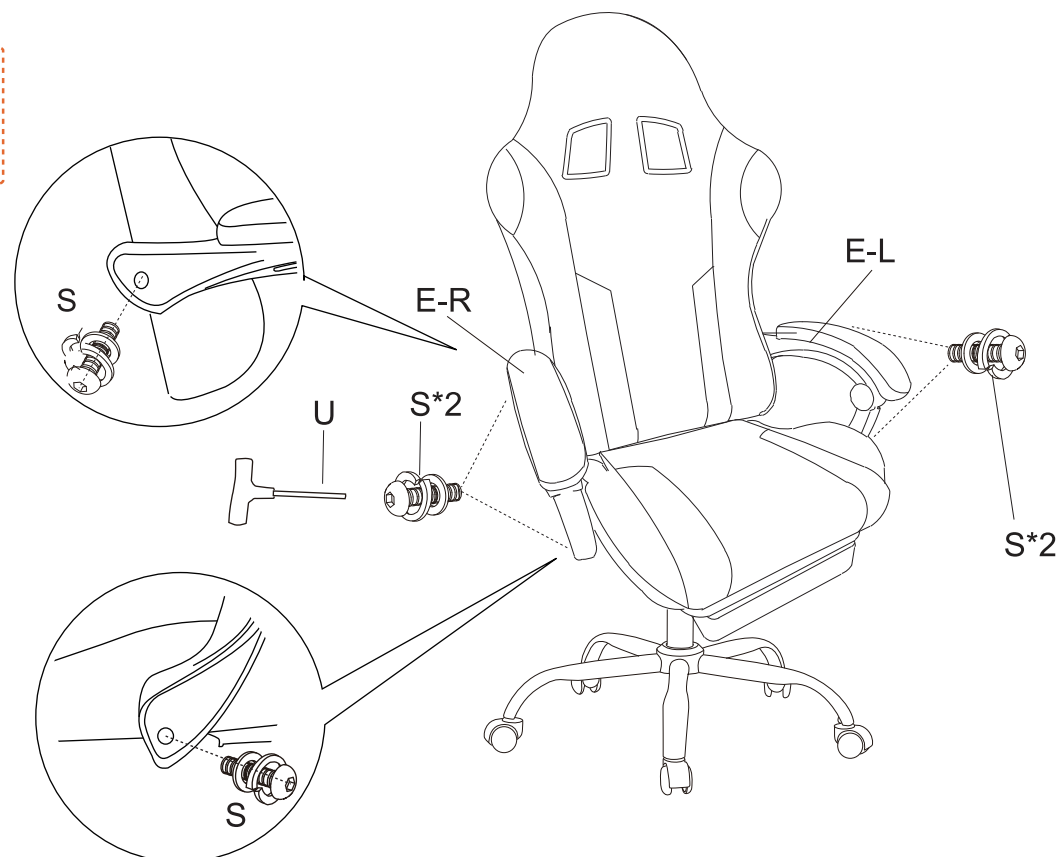
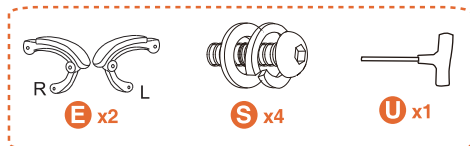

EN Note:
First, do not tighten all the bolts, tighten them all after the installation is complete

DE Hinweis:
Ziehen Sie nicht alle Schrauben sofort fest, sondern erst nach Abschluss der Montage.

FR Note:
Avant de serrer tous les boulons, assurez-vous de les serrer tous après l'installation complète.

Instructions For Use

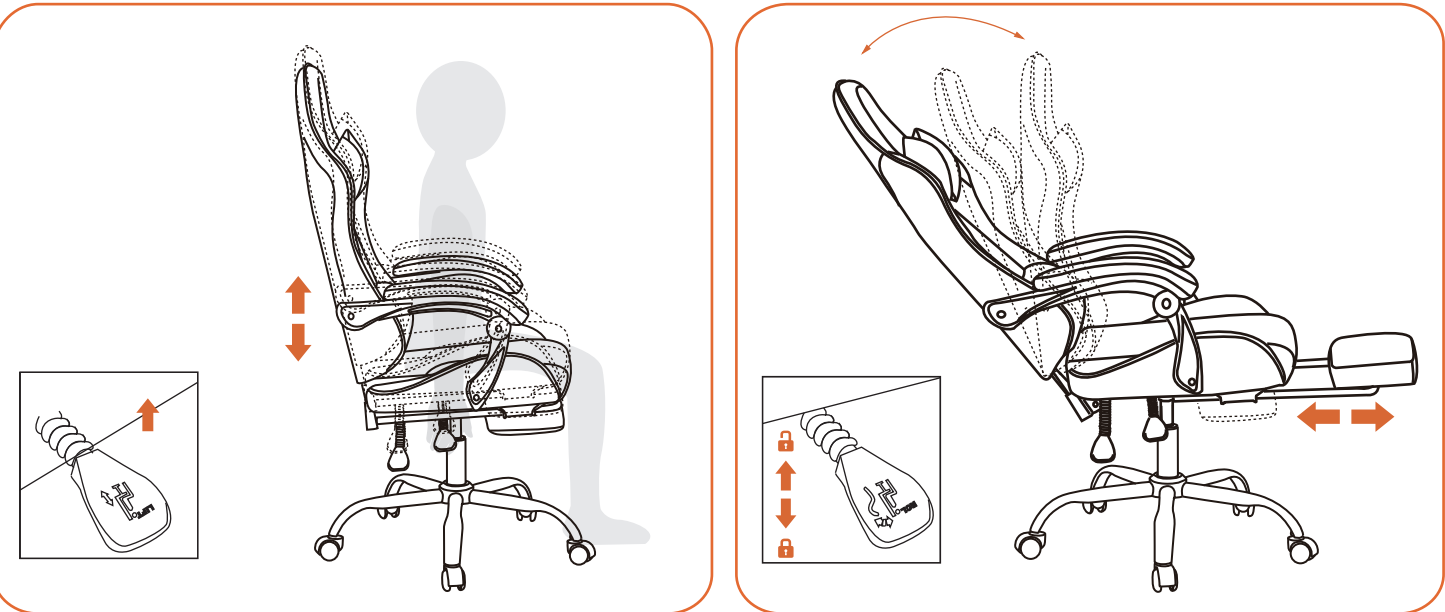

EN CAUTION:
Before using the chair, check to ensure that all bolts are fully tightened.

DE VORSICHT:
Überprüfen Sie vor der Benutzung des Stuhls, ob alle Schrauben vollständig angezogen sind.

FR ATTENTION :
Avant d'utiliser la chaise, vérifiez que tous les boulons sont bien serrés.