

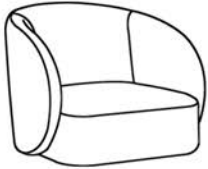





ASSEMBLY INSTRUCTION

A×1 	B×1 	C×1 	H1×4 	H2×4 	H3×1 
---	--	--	--	---	---

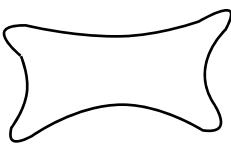
- 1** Locate the hardware pack attached to the Chair Base (A). Make sure all parts and hardware are present before assembly. Assemble on a soft and smooth surface to prevent damage to product.

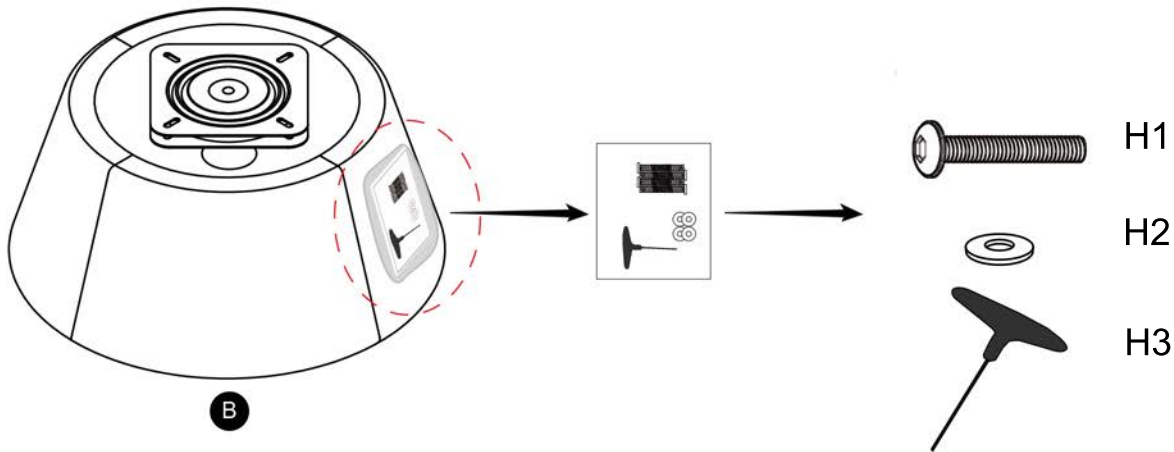

- 2** Rotate the swivel plate by 45 degree.

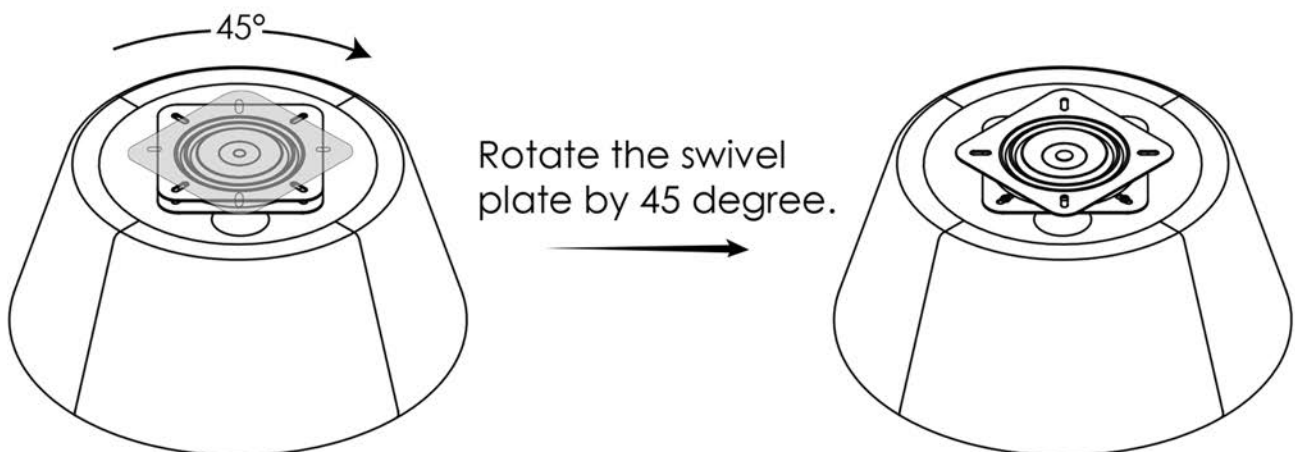

- 3** Attach the Chair Base (B) to Chair Body (A), using Bolts(H1), and Flat Washers(H2).

Note: **Loosely** attach the bolts one by one and **keep them loose**. Do not **fully tighten**. After **loosely** attach the first bolt, rotate the base to attach the next one. After all 4 bolts are attached, use Allen Wrench(H3) to tighten.

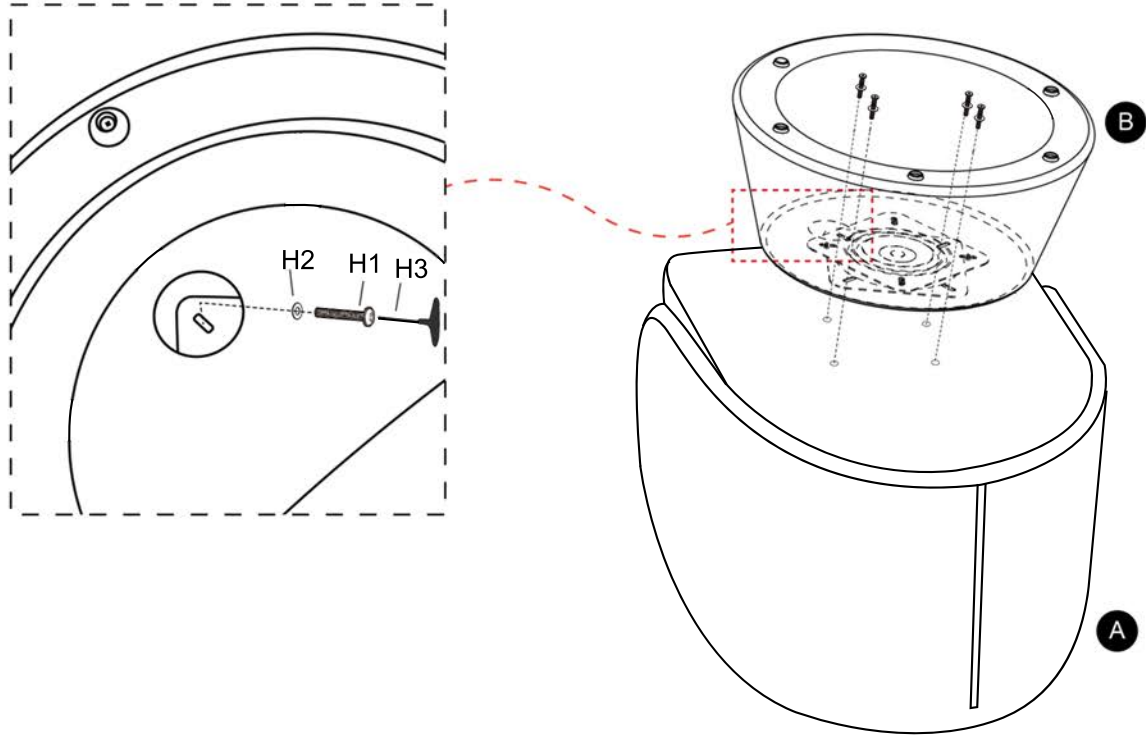

- 4** Assembly complete. Take a spin and enjoy.

